

## VOLTAGE COMPARATOR

### ■ GENERAL DESCRIPTION

The NJM319 is precision high-speed dual comparator fabricated on a single monolithic chip. It is designed to operate over a wide range of supply voltages down to single 5V logic and ground. The uncommitted collector of the output stage makes the NJM319 compatible with RTL, DTL and TTL as well as capable of driving lamps and relays at currents up to 25mA.

### ■ FEATURES

- Operating Voltage ( +5V~+36V )
- Single Supply Operation
- Response Time ( 80ns typ. )
- Output Current ( 25mA @ Sink Current )
- Package Outline DIP14, DMP14, SSOP14
- Bipolar Technology

### ■ PACKAGE OUTLINE

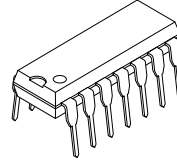

NJM319D

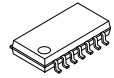

NJM319M



NJM319V

### ■ PIN CONFIGURATION

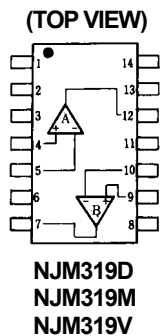

#### PIN FUNCTION

- |                   |                    |
|-------------------|--------------------|
| 1. NC             | 8. B GND           |
| 2. NC             | 9. B +INPUT        |
| 3. A GND          | 10. B -INPUT       |
| 4. A +INPUT       | 11. V <sup>+</sup> |
| 5. A -INPUT       | 12. A OUTPUT       |
| 6. V <sup>-</sup> | 13. NC             |
| 7. B OUTPUT       | 14. NC             |

### ■ EQUIVALENT CIRCUIT ( 1/2 Shown )

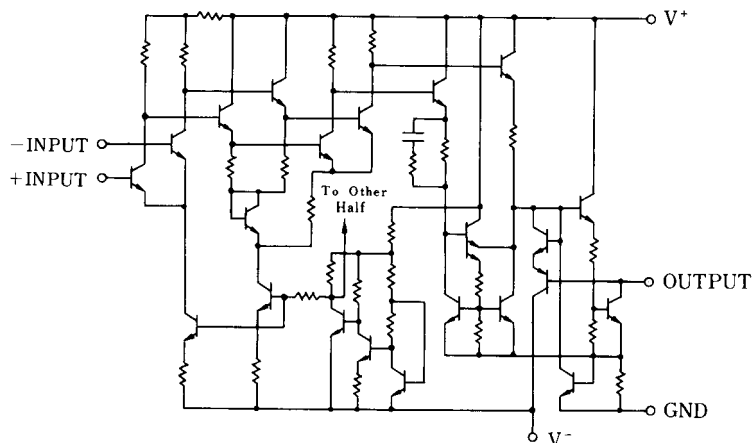

# NJM319

## ■ ABSOLUTE MAXIMUM RATINGS

( Ta=25°C )

PARAMETER	SYMBOL	RATINGS	UNIT
Supply Voltage	$V^+V^-$	36	V
Input Voltage	$V_{IC}$	$\pm 15$ ( note1 )	V
Differential Input Voltage	$V_{ID}$	$\pm 5$ ( note2 )	V
Power Dissipation	$P_D$	( DIP14 ) 500 ( DMP14 ) 300 ( SSOP14 ) 300	mW
Output to Negative Supply Voltage	$\Delta V_{O-N}$	36	V
GND to Negative Supply Voltage	$\Delta V_{G-N}$	25	V
GND to Positive Supply Voltage	$\Delta V_{G-P}$	18	V
Operating Temperature Range	$T_{opr}$	-40~+85	°C
Storage Temperature Range	$T_{stg}$	-40~+125	°C

( note1 ) For supply voltage less than  $\pm 15V$ , the absolute maximum input voltage is equal to the supply voltage.

( note2 ) Do not apply voltage more than 5V at the point between +INPUT and -INPUT.

## ■ ELECTRICAL CHARACTERISTICS

( Ta=25°C,  $V^+V^- = \pm 15V$  )

PARAMETER	SYMBOL	TEST CONDITION	MIN.	TYP.	MAX.	UNIT
Input Offset Voltage	$V_{IO}$	$R_S \leq 5k\Omega$	-	2.0	8.0	mV
Input Offset Current	$I_{IO}$		-	80	200	nA
Input Bias Current	$I_B$		-	250	1000	nA
Voltage Gain	$A_V$		78	92	-	dB
Response Time	$t_R$	$V_{IN}$ : 100mV Step Input 5mV Over Drive	-	80	-	ns
Saturation Voltage	$V_{SAT}$	$V_{IN} \leq 10mV, I_{SINK} = 25mA$	-	0.75	1.5	V
Output Leakage Current	$I_{LEAK}$	$V_{IN} \geq 10mV, V^- = GND = 0V, V_{OUT} = 35V$	-	0.2	10	$\mu A$
Positive Supply Current	$I^+1$	$V^+ = 5V, V^- = 0V$	-	4.3	-	mA
Positive Supply Current	$I^+2$		-	8	12.5	mA
Negative Supply Current	$I^-$		-	3	5	mA

## ■ TYPICAL CHARACTERISTICS

**Input Bias Current vs. Temperature**

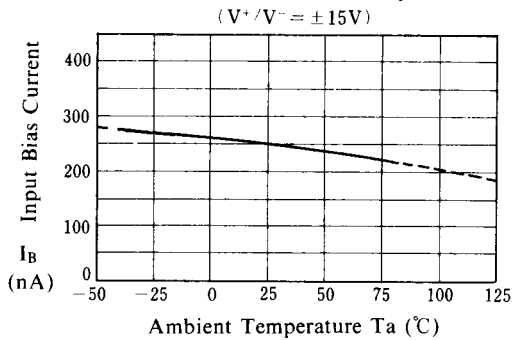

**Input Offset Voltage vs. Temperature**

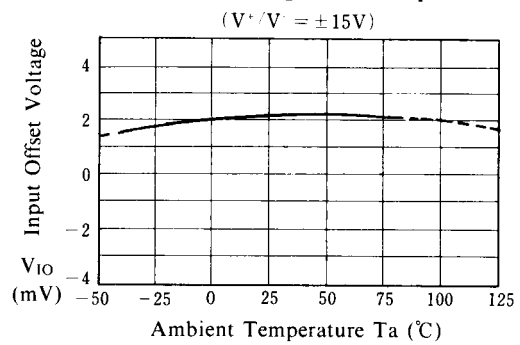

**Operating Current vs. Operating Voltage**

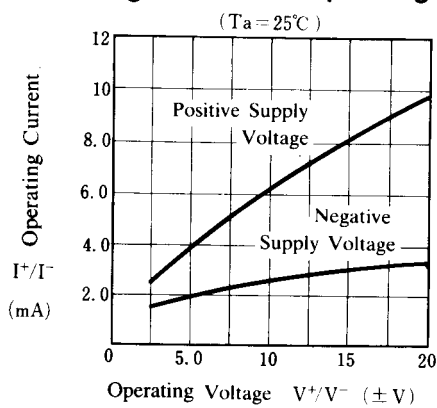

**Transfer Function**

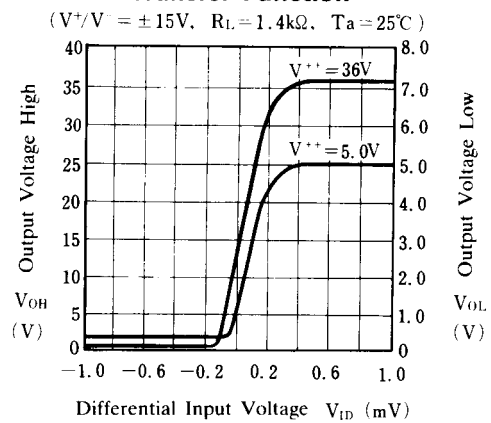

**Response Time for Various Input Overdrives**

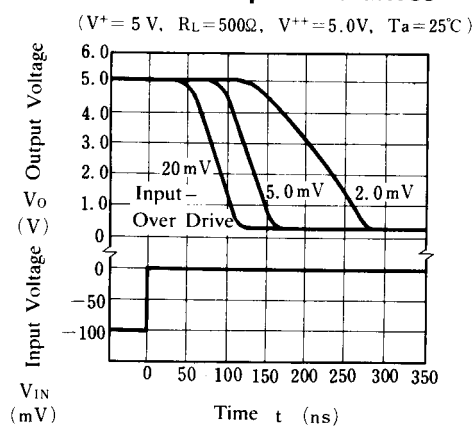

**Response Time for Various Input Overdrives**

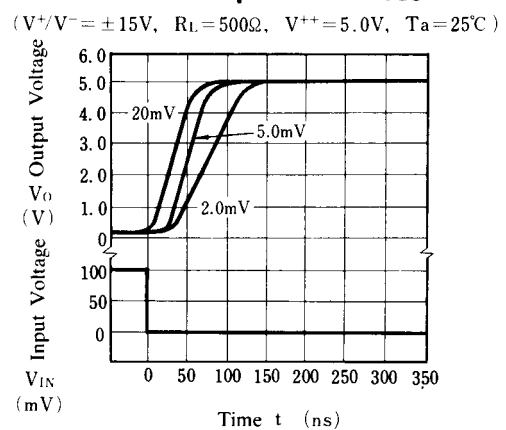

# NJM319

## ■ TYPICAL CHARACTERISTICS

**Response Time for Various Input Overdrives**

( $V^+/V^- = \pm 15V$ ,  $R_L = 500\Omega$ ,  $V^{++} = 5.0V$ ,  $T_a = 25^\circ C$ )

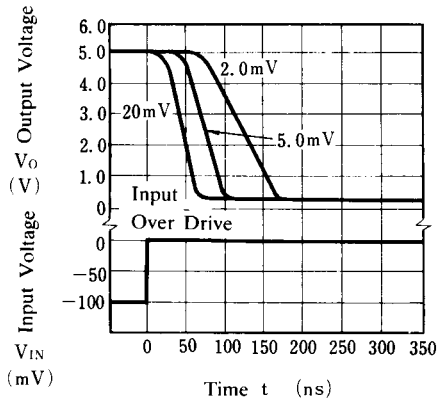

**Response Time for Various Input Overdrives**

( $V^+ = 5V$ ,  $R_L = 500\Omega$ ,  $V^{++} = 5V$ ,  $T_a = 25^\circ C$ )

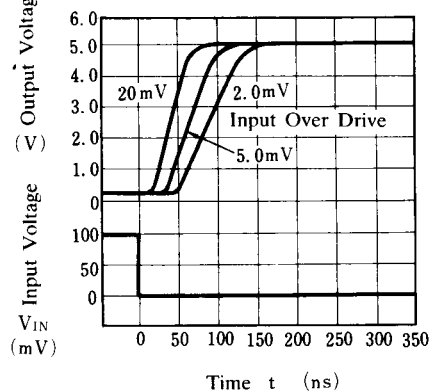

## ■ TYPICAL APPLICATIONS

**Relay Driver**

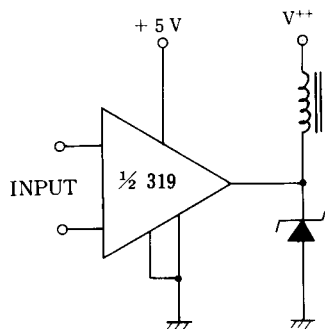

**Window Detector**

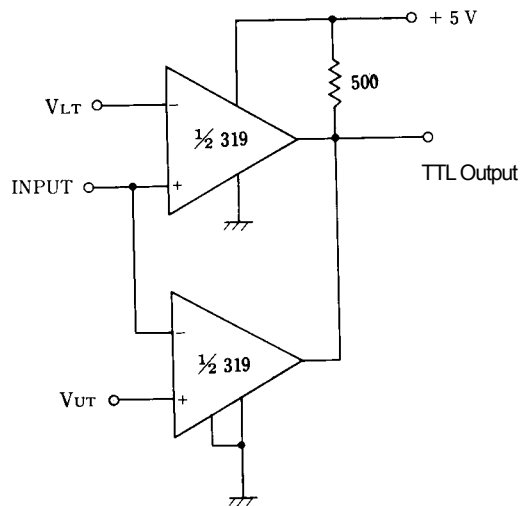

**[CAUTION]**

The specifications on this databook are only given for information, without any guarantee as regards either mistakes or omissions. The application circuits in this databook are described only to show representative usages of the product and not intended for the guarantee or permission of any right including the industrial rights.