



## Transformer Coupled ISOLATION AMPLIFIER

### FEATURES

- INTERNAL ISOLATED POWER
- 8000V ISOLATION TEST VOLTAGE
- 0.5 $\mu$ A MAX LEAKAGE AT 120V, 60Hz
- 3-PORT ISOLATION
- IMR: 125dB REJECTION AT 60Hz
- 1" x 1" x 0.25" CERAMIC PACKAGE

### APPLICATIONS

- **MEDICAL**  
Patient Monitoring and Diagnostic Instrumentation
- **INDUSTRIAL**  
Ground Loop Elimination and Off-ground Signal Measurement
- **NUCLEAR**  
Input/Output/Power Isolation

### DESCRIPTION

The 3656 was the first amplifier to provide a total isolation function, both signal and power isolation, in integrated circuit form. This remarkable advancement in analog signal processing capability was accomplished by use of a patented modulation technique and miniature hybrid transformer.

Versatility and performance are outstanding features of the 3656. It is capable of operating with three

completely independent grounds (three-port isolation). In addition, the isolated power generated is available to power external circuitry at either the input or output. The uncommitted op amps at the input and the output allow a wide variety of closed-loop configurations to match the requirements of many different types of isolation applications.

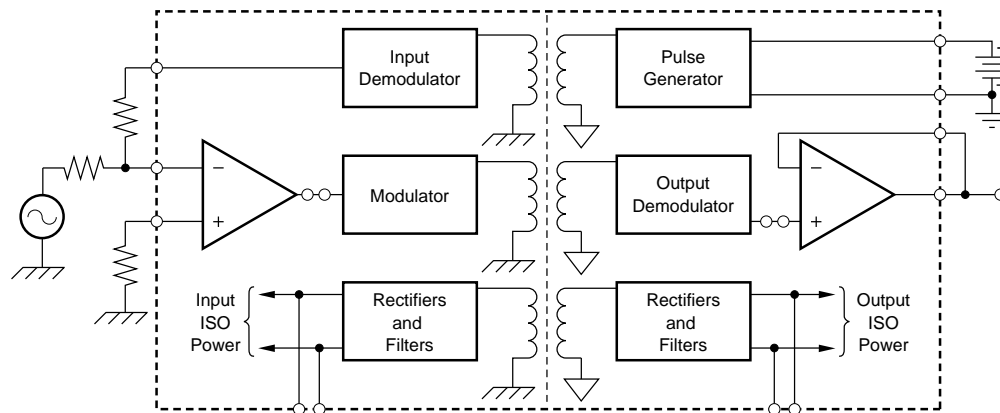

This product is covered by the following United States patents: 4,066,974; 4,103,267; 4,082,908. Other patents pending may also apply upon the allowance and issuance of patents thereon. The product may also be covered in other countries by one or more international patents corresponding to the above-identified U.S. patents.



# SPECIFICATIONS (CONT)

## ELECTRICAL

At +25°C, V± = 15VDC and 15VDC between P+ and P-, unless otherwise specified.

| PARAMETER  | CONDITIONS  | 3656AG, BG, HG, JG, KG |   |                            | UNITS                                  |
|--|---|------------------------|---|----------------------------|--|
|  |   | MIN                    | TYP   | MAX                        |  |
| <b>FREQUENCY RESPONSE</b><br>±3dB Response<br>Full Power<br>Slew Rate<br>Settling Time   | Small Signal<br><br>Direction Measured at Output to 0.05%   | +0.1, -0.04            | 30<br>1.3<br>500  |                            | kHz<br>kHz<br>V/μs<br>μs               |
| <b>OUTPUT</b><br>Noise Voltage (RTI)<br><br>Residual Ripple <sup>(9)</sup>   | f <sub>B</sub> = 0.05Hz to 100Hz<br><br>f <sub>B</sub> = 10Hz to 10kHz  |                        | $\sqrt{(5)^2 + (22/G_1)^2}$<br>$\sqrt{(5)^2 + (11/G_1)^2}$<br>5 |                            | μVp-p<br>μVrms<br>mVp-p                |
| <b>POWER SUPPLY IN, at P+, P-</b><br>Rated Performance<br>Voltage Range <sup>(10)</sup><br>Ripple Current <sup>(9)</sup><br>Quiescent Current <sup>(11)</sup><br>Current vs Load Current <sup>(12)</sup> | Derated Performance<br><br>Average<br>vs Current from +V, -V, V+, V-  | 8.5                    | 15<br>10<br>14<br>0.7   | 16<br>25<br>18             | VDC<br>VDC<br>mA/p-p<br>mA/DC<br>mA/mA |
| <b>ISOLATED POWER OUT, At +V, -V, V+, V- pins<sup>(13)</sup></b><br>Voltage, No Load<br>Voltage, Full Load<br>Voltage vs Power Supply<br>Ripple Voltage <sup>(9)</sup><br>No Load<br>Full Load           | 15V Between P+ and P-<br>±5mA (10mA sum) Load <sup>(12)</sup><br>vs Supply Between P+ and P-<br><br>±5mA Load | 8.5<br>7               | 9<br>8<br>0.66<br><br>40<br>80                                  | 9.5<br>9                   | V<br>V<br>V/V<br><br>mVp-p<br>mVp-p    |
| <b>TEMPERATURE RANGE</b><br>Specification 3656AG, BG<br>3656HG, JG, KG<br>Operation <sup>(10)</sup><br>Storage <sup>(14)</sup>   |   | -25<br>0<br>-55<br>-65 |   | +85<br>+70<br>+100<br>+125 | °C<br>°C<br>°C<br>°C                   |

NOTES: (1) Ratings in parenthesis are between P- (pin 20) and O/P Com (pin 17). Other isolation ratings are between I/P Com and O/P Com or I/P Com and P-. (2) See Performance Curves. (3) May be trimmed to zero. (4) If output swing is unipolar, or if the output is not loaded, specification same as if external supply were used. (5) Includes effects of A<sub>1</sub> and A<sub>2</sub> offset voltages and bias currents if recommended resistors used. (6) Versus the sum of all external currents drawn from V+, V-, +V, -V (= ISO). (7) Effects of A<sub>1</sub> and A<sub>2</sub> bias currents and offset currents are included in Offset Voltage specifications. (8) With respect to I/P Com (pin 3) for A<sub>1</sub> and with respect to O/P Com (pin 17) for A<sub>2</sub>. CMR for A<sub>1</sub> and A<sub>2</sub> is 100dB, typical. (9) In configuration of Figure 3. Ripple frequency approximately 750kHz. Measurement bandwidth is 30kHz. (10) Decreases linearly from 16VDC at 85°C to 12VDC at 100°C. (11) Instantaneous peak current required from pins 19 and 20 at turn-on is 100mA for slow rising voltages (50ms) and 300mA for fast rises (50μs). (12) Load current is sum drawn from +V, -V, V+, V- (= I<sub>ISO</sub>). (13) Maximum voltage rating at pins 1 and 4 is ±18VDC; maximum voltage rating at pins 12 and 16 is ±18VDC. (14) Isolation ratings may degrade if exposed to 125°C for more than 1000 hours or 90°C for more than 50,000 hours.

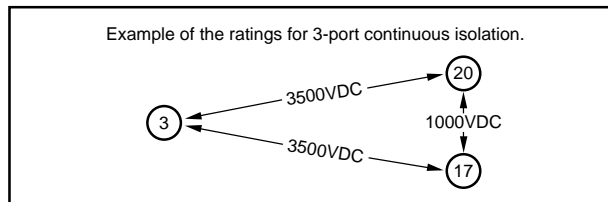

## PACKAGE INFORMATION

| PRODUCT | PACKAGE          | PACKAGE DRAWING NUMBER <sup>(1)</sup> |
|---------|------------------|---------------------------------------|
| 3656    | 20-Lead ISO Omni | 102A                                  |

NOTE: (1) For detailed drawing and dimension table, please see end of data sheet, or Appendix C of Burr-Brown IC Data Book.

## PIN DESIGNATIONS

| NO. | DESCRIPTION                       | NO. | DESCRIPTION                       |
|-----|-----------------------------------|-----|-----------------------------------|
| 1   | +V                                | 11  | Output DEMOD                      |
| 2   | MOD Input                         | 12  | V-                                |
| 3   | Input DEMOD COM                   | 13  | A <sub>2</sub> Noninverting Input |
| 4   | -V                                | 14  | A <sub>2</sub> Inverting Input    |
| 5   | Balance                           | 15  | A <sub>2</sub> Output             |
| 6   | A <sub>1</sub> Inverting Input    | 16  | V+                                |
| 7   | A <sub>1</sub> Noninverting Input | 17  | Output DEMOD COM                  |
| 8   | Balance                           | 18  | No Pin                            |
| 9   | A <sub>1</sub> Output             | 19  | P+                                |
| 10  | Input DEMOD                       | 20  | P-                                |

## ABSOLUTE MAXIMUM RATINGS

|   |                  |
|---|------------------|
| Supply Without Damage .....                       | 16V              |
| Input Voltage Range Using Internal Supply .....   | ±8V              |
| Input Voltage Range Using External Supply .....   | Supply           |
| Continuous Isolation Voltage <sup>(1)</sup> ..... | 3500, (1000) VDC |
| Storage Temperature .....                         | -65°C to +125°C  |
| Lead Temperature, (soldering, 10s) .....          | +300°C           |

NOTE: (1) Ratings in parenthesis are between P- (pin 20) and O/P Com (pin 17). Other isolation ratings are between I/P Com and O/P Com or I/P Com and P-.

# TYPICAL PERFORMANCE CURVES

All specifications typical at +25°C, unless otherwise specified.

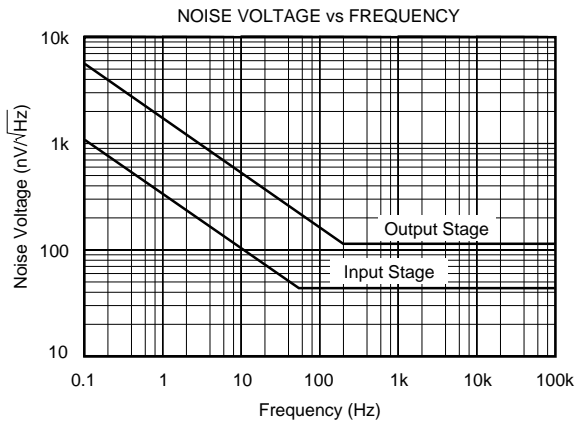
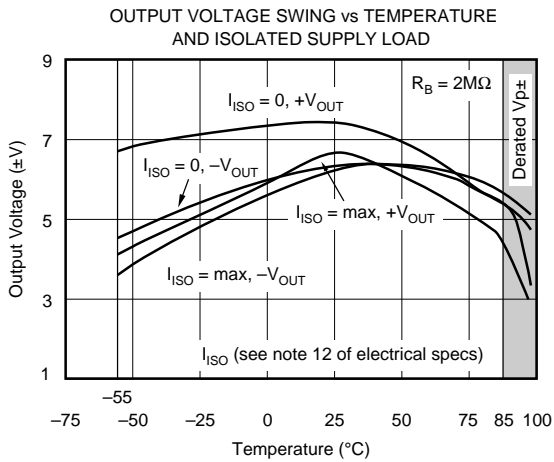
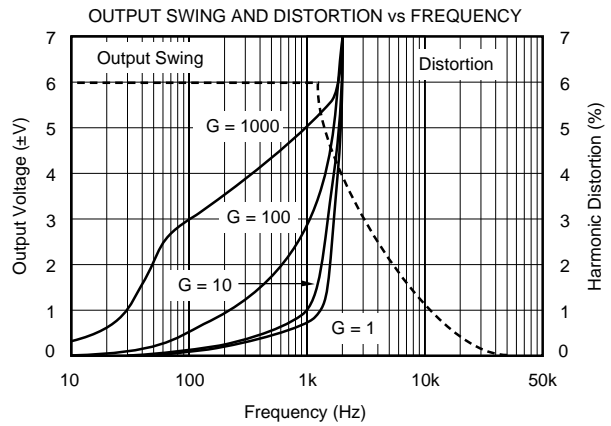
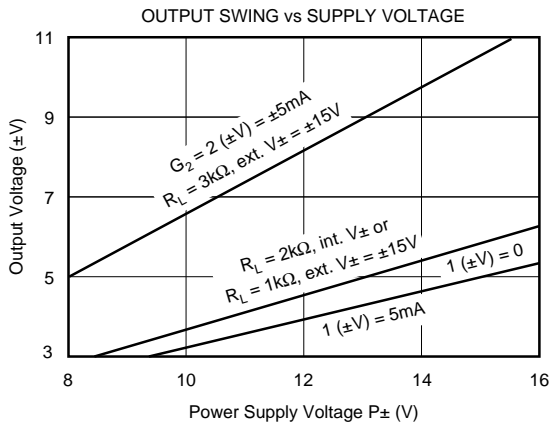
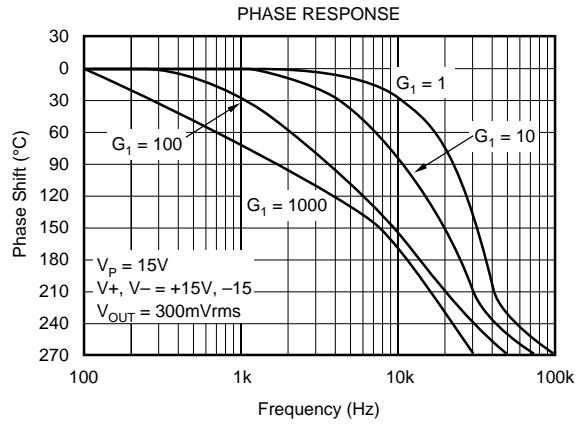
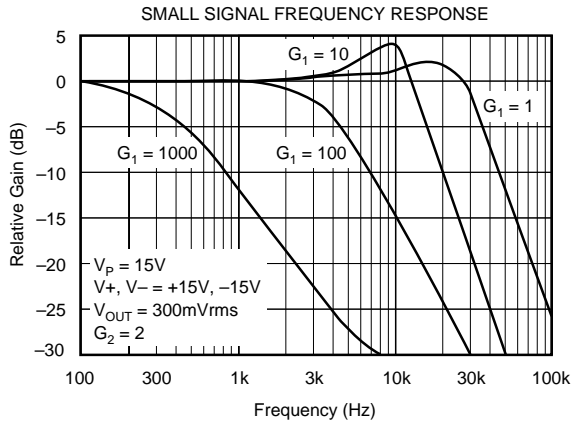

# TYPICAL PERFORMANCE CURVES (CONT)

All specifications typical at +25°C, unless otherwise specified.

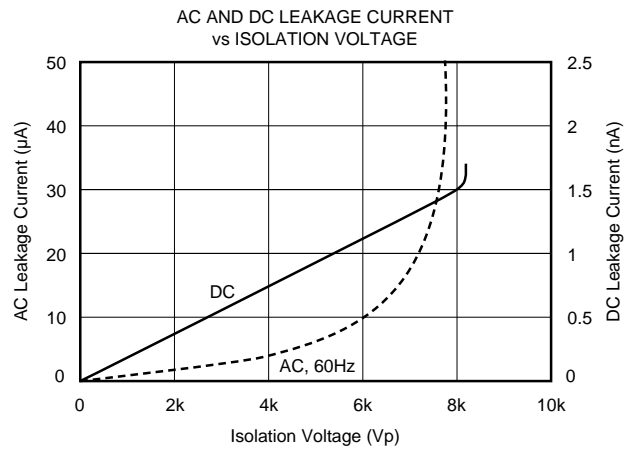
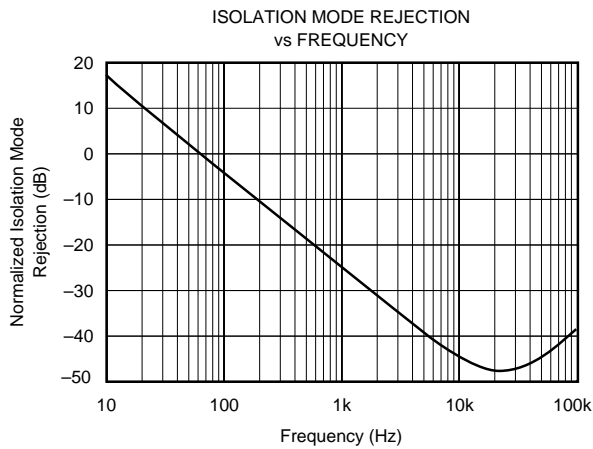
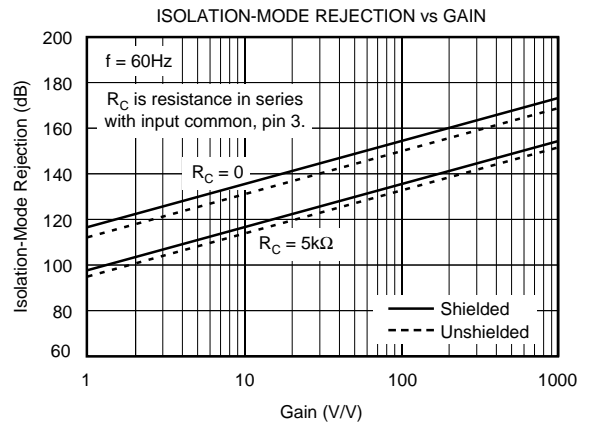
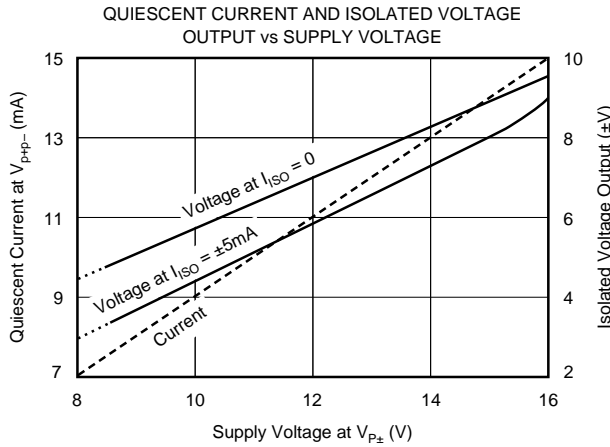
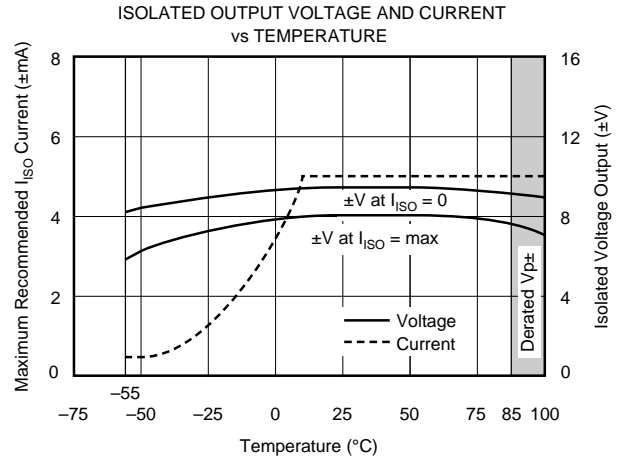
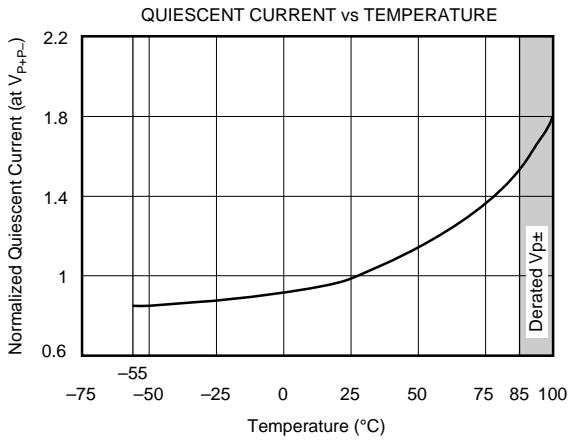

# THEORY OF OPERATION

Details of the 3656 are shown in Figure 1. The external connections shown, place it in its simplest gain configuration—unity gain, noninverting. Several other amplifier gain configurations and power isolation configurations are possible. See Installation and Operating Instructions and Applications sections for details.

Isolation of both signal and power is accomplished with a single miniature toroid transformer with multiple windings. A pulse generator operating at approximately 750kHz provides a two-part voltage waveform to transformer,  $T_1$ . One part of the waveform is rectified by diodes  $D_1$  through  $D_4$  to provide the isolated power to the input and output stages ( $+V$ ,  $-V$  and  $V+$ ,  $V-$ ). The other part of the waveform is modulated with input signal information by the modulator operating into the  $V_2$  winding of the transformer.

The modulated signal is coupled by windings  $W_6$  and  $W_7$  to two matched demodulators—one in the input stage and one in the output stage—which generate identical voltages at their outputs, pins 10 and 11 (Voltages identical with respect to their respective commons, pins 3 and 17). In the input stage the input amplifier,  $A_1$ , the modulator and the input demodulator are connected in a negative feedback loop. This forces the voltage at pin 6 (connect as shown in Figure 1) to equal the input signal voltage applied at pin 7. Since the input and the output demodulators are matched and produce identical output voltages, the voltage at pin 11 (referenced to pin 17, the output common) is equal to the voltage at pin 10 (referenced to pin 3, the input common). In the output stage, output amplifier  $A_2$  is connected as a unity gain buffer, thus the output voltage at pin 15 equals the input demodulator voltage at pin 11. The end result is an isolated output voltage

at pin 15 equal to the input voltage at pin 7 with no galvanic connection between them.

Several amplifier and power connection variations are possible:

1. The input stage may be connected in various operational amplifier gain configurations.
2. The output stage may be operated at gains above unity.
3. The internally generated isolated voltages which provide power to  $A_1$  and  $A_2$  may be overridden and external supply voltages used instead.

Versatility and its three independent isolated grounds allow simple solutions to demanding analog signal conditioning problems. See the Installation and Operating Instructions and Applications sections for details.

# INSTALLATION AND OPERATING INSTRUCTIONS

The 3656 is a very versatile device capable of being used in a variety of isolation and amplification configurations. There are several fundamental considerations that determine configuration and component value constraints:

1. Consideration must be given to the load placed on the resistance (pin 10 and pin 11) by external circuitry. Their output resistance is  $100k\Omega$  and a load resistor of  $2M\Omega$  or greater is recommended to prevent a voltage divider loading effect in excess of 5%.

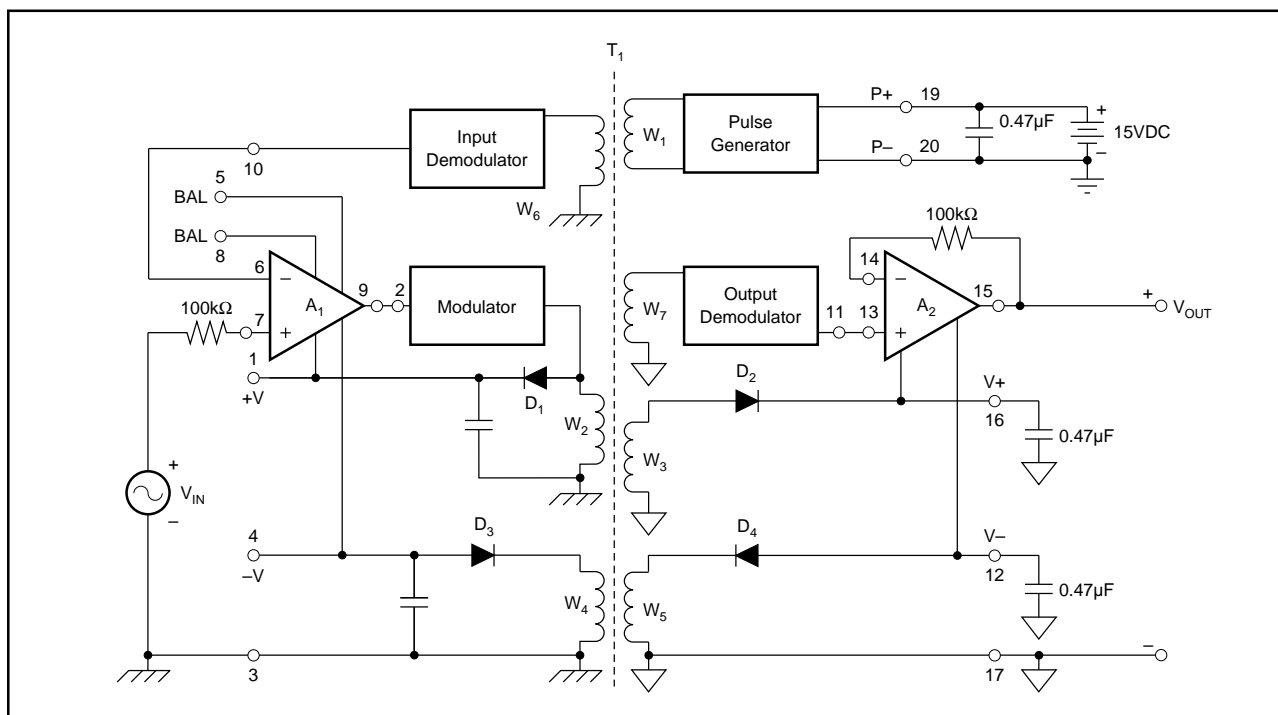

FIGURE 1. Block Diagram.

2. Demodulator loadings should be closely matched so their output voltages will be equal. (Unequal demodulator output voltages will produce a gain error.) At the  $2M\Omega$  level, a matching error of 5% will cause an additional gain error of 0.25%.
3. Voltage swings at demodulator outputs should be limited to 5V. The output may be distorted if this limit is exceeded. This constrains the maximum allowed gains of the input and output stages. Note that the voltage swings at demodulator outputs are tested with  $2M\Omega$  load for a minimum of 5V.
4. Total current drawn from the internal isolated supplies must be limited to less than  $\pm 5\text{mA}$  per supply and limited to a total of 10mA. In other words, the combination of external and internal current drawn from the internal circuitry which feeds the +V, -V, V+ and V- pins should be limited to 5mA per supply (total current to +V, -V, V+ and V- limited to 10mA). The internal filter capacitors for  $\pm V$  are  $0.01\mu\text{F}$ . If more than 0.1mA is drawn to provide isolated power for external circuitry (see Figure 12), additional capacitors are required to provide adequate filtering. A minimum of  $0.1\mu\text{F}/\text{mA}$  is recommended.
5. The input voltage at pin 7 (noninverting input to  $A_1$ ) must not exceed the voltage at pin 4 (negative supply voltage for  $A_1$ ) in order to prevent a possible lockup condition. A low leakage diode connected between pins 7 and 4, as shown in Figure 2, can be used to limit this input voltage swing.
6. Impedances seen by each amplifier's + and - input terminals should be matched to minimize offset voltages caused by amplifier input bias currents. Since the demodulators have a  $100\text{k}\Omega$  output resistance, the amplifier input not connected to the demodulator should also see  $100\text{k}\Omega$ .
7. All external filter capacitors should be mounted as close to the respective supply pins as possible in order to prevent excessive ripple voltages on the supplies or at the output. (Optimum spacing is less than 0.5". Ceramic capacitors recommended.)

## POWER AND SIGNAL CONFIGURATIONS

NOTE: Figures 2, 3 and 4 are used to illustrate both signal and power connection configurations. In the circuits shown, the power and signal configurations are independent so that any power configuration could be used with any signal configuration.

### ISOLATED POWER CONFIGURATIONS

The 3656 is designed with isolation between the input, the output, and the power connections. The internally generated isolated voltages supplied to  $A_1$  and  $A_2$  may be overridden with external voltages greater than the internal supply volt-

ages. These two features of 3656 provide a great deal of versatility in possible isolation and power supply hook-ups. When external supplies are applied, the rectifying diodes ( $D_1$  through  $D_4$ ) are reverse biased and the internal voltage sources are decoupled from the amplifiers (see Figure 1). Note that when external supplies are used, they must never be lower than the internal supply voltage.

### Three-Port

The power supply connections in Figure 2 show the full three-port isolation configuration. The system has three separate grounds with no galvanic connections between them. The two external  $0.47\mu\text{F}$  capacitors at pins 12 and 16 filter the rectified isolated voltage at the output stage. Filtering on the input stage is provided by internal capacitors. In this configuration continuous isolation voltage ratings are: 3500V between pins 3 and 17; 3500V between pins 3 and 19; 1000V between pins 17 and 19.

### Two-Port Bipolar Supply

Figure 3 shows two-port isolation which uses an external bipolar supply with its common connected to the output stage ground (pin 17). One of the supplies (either + or - could be used) provides power to the pulse generator (pins 19 and 20). The same sort of configuration is possible with the external supplies connected to the input stage. With the connection shown, filtering at pins 12 and 16 is not required. In this configuration continuous isolation voltage rating is: 3500VDC between pins 3 and 17; not applicable between pins 17 and 19; 3500VDC between pins 3 and 19.

### Two-Port Single Supply

Figure 4 demonstrates two-port isolation using a single polarity supply connected to the output common (pin 17). The other polarity of supply for  $A_2$  is internally generated (thus the filtering at pin 12). This isolated power configuration could be used at the input stage as well and either polarity of supply could be employed. In this configuration continuous isolation voltage rating is: 3500V between pins 3 and 17; 3500V between pins 3 and 19; not applicable between pins 17 and 19.

## SIGNAL CONFIGURATIONS

### Unity Gain Noninverting

The signal path portion of Figure 2 shows the 3656 is its simplest gain configuration: unity gain noninverting. The two  $100\text{k}\Omega$  resistors provide balanced resistances to the inverting and noninverting inputs of the amplifiers. The diode prevents latch up in case the input voltage goes more negative than the voltage at pin 4.

### Noninverting With Gain

The signal path portion of Figure 3 demonstrates two additional gain configurations: gain in the output stage and noninverting gain in the input stage. The following equations apply:

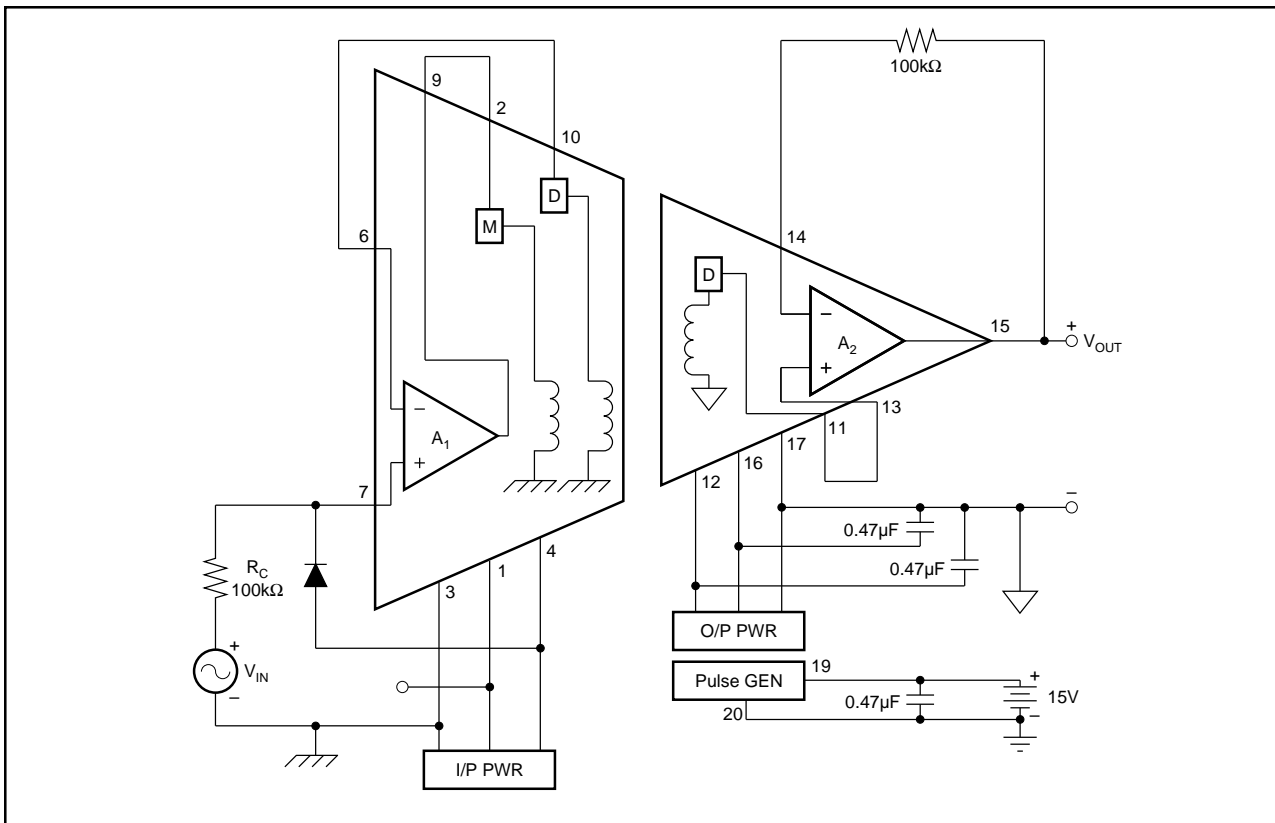

FIGURE 2. Power: Three-Port Isolation; Signal: Unity-Gain Noninverting.

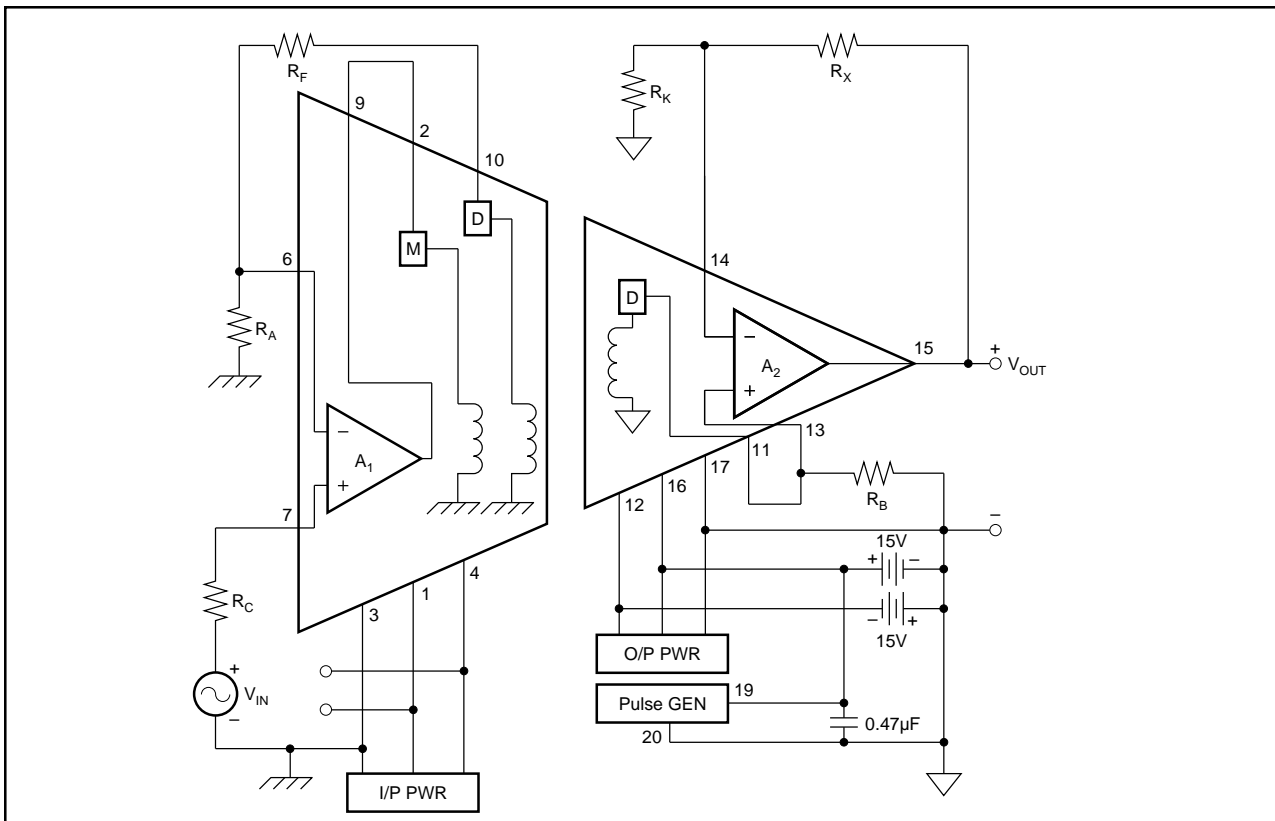

FIGURE 3. Power: Two-Port, Dual Supply; Signal: Noninverting Gain.



Total amplifier gain:

$$G = G_1 \cdot G_2 = V_{OUT} / V_{IN} \quad (1)$$

Input Stage:

$$G_1 = 1 + (R_A / F_A) \quad (2)$$

(Select  $G_1$  to be less than 5V/full scale  $V_{IN}$  to limit demodulator output to 5V).

$$R_A + R_F \geq 2M\Omega \quad (3)$$

(Select to load input demodulator with at least 2MΩ).

$$R_C = R_A \parallel (R_F + 100k\Omega) = \frac{R_A (R_F + 100k\Omega)}{R_A + R_F + 100k\Omega} \quad (4)$$

(Balance impedances seen by the + and - inputs of  $A_1$  to reduce input offset caused by bias current).

Output Stage:

$$G_2 = 1 + (R_X / R_K) \quad (5)$$

(Select ratio to obtain  $V_{OUT}$  between 5V and 10V full scale with  $V_{IN}$  at its maximum).

$$R_X \parallel R_K = 100k\Omega \quad (6)$$

(Balance impedances seen by the + and - inputs of  $A_2$  to reduce effect of bias current on the output offset).

$$R_B = R_A + R_F \quad (7)$$

(Load output demodulator equal to input demodulator).

### Inverting Gain, Voltage or Current Input

The signal portion of Figure 4 shows two possible inverting input stage configurations: current and input, and voltage input.

Input Stage:

For the voltage input case:

$$G_1 = -R_F / R_S \quad (8)$$

(Select  $G_1$  to be less than 5V/full scale  $V_{IN}$  to limit the demodulator output voltage to 5V).

$$R_F = 2M\Omega \quad (9)$$

(Select to load the demodulator with at least 2MΩ).

$$R_C = R_S \parallel (R_1 + 100k\Omega) = \frac{R_S (R_F + 100k\Omega)}{R_S + R_F + 100k\Omega} \quad (10)$$

(Balance the impedances seen by the + and - inputs of  $A_1$ ).

For the current input case:

$$V_{OUT} = -I_{IN} R_F \cdot G_2 \quad (11)$$

$$R_C = R_F \quad (12)$$

$R_F$  may be made larger than 2MΩ if desired. The 10pF capacitors are used to compensate for the input capacitance of  $A_1$  and to insure frequency stability.

Output Stage:

The output stage is the same as shown in equations (5), (6), and (7).

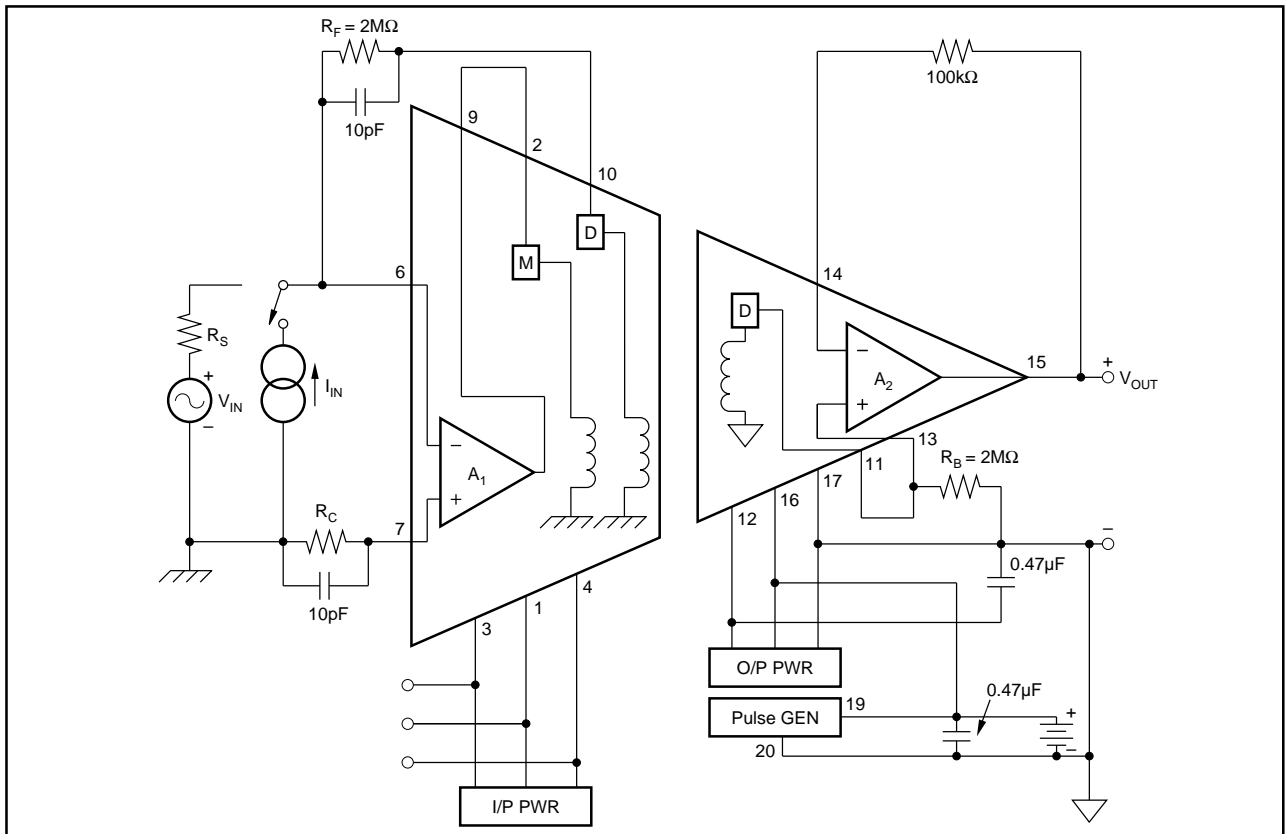

FIGURE 4. Power: Two-Port, Single Supply; Signal: Inverting Gains.

### Illustrative Calculations:

The maximum input voltage is 100mV. It is desired to amplify the input signal for maximum accuracy. Noninverting output is desired.

#### Input Stage:

##### Step 1

$$G_1 \text{ max} = 5V/\text{max Input Signal} = 5V/0.1V = 50V/V$$

With the above gain of 50V/V, if the input ever exceeds 100mV, it would drive the output to saturation. Therefore, it is good practice to allow reasonable input overrange.

So, to allow for 25% input overrange without saturation at the output, select:

$$G_1 = 40V/V$$

$$G_1 = 1 + (R_F + R_A) = 40$$

$$\therefore R_F + R_A = 39 \quad (13)$$

##### Step 2

$R_A + R_F$  forms a voltage divider with the 100k $\Omega$  output resistance of the demodulator. To limit the voltage divider loading effect to no more than 5%,  $R_A + R_F$  should be chosen to be at least 2M $\Omega$ . For most applications, the 2M $\Omega$  should be sufficiently large for  $R_A + R_F$ . Resistances greater than 2M $\Omega$  may help decrease the loading effect, but would increase the offset voltage drift.

The voltage divider with  $R_A + R_F = 2M\Omega$  is  $2M\Omega/(2M\Omega + 100k\Omega) = 2/(2 + 0.1) = 95.2\%$ , i.e., the percent loading is 4.8%.

$$\text{Choose } R_A + R_F = 2M\Omega \quad (14)$$

##### Step 3

Solving equations (13) and (14)

$$R_A = 50k\Omega \text{ and } R_F = 1.95M\Omega$$

##### Step 4

The resistances seen by the + and – input terminals of the input amplifier  $A_1$  should be closely matched in order to minimize offset voltage due to bias currents.

$$\begin{aligned} \therefore R_C &= R_A \parallel (R_F + 100k\Omega) \\ &= 50k\Omega \parallel (1.95M\Omega + 100k\Omega) \\ &\approx 49k\Omega \end{aligned}$$

#### Output Stage:

##### Step 5

$$V_{OUT} = V_{IN \text{ MAX}} \cdot G_1 \cdot G_2$$

As discussed in Step 1, it is good practice to provide 25% input overrange.

So we will calculate  $G_2$  for 10V output and 125% of the maximum input voltage.

$$\begin{aligned} \therefore V_{OUT} &= (1.25 \cdot 0.1)(G_1)(G_2) \\ \text{i.e., } 10V &= 0.125 \cdot 40 \cdot G_2 \\ \therefore G_2 &= 10V/5V = 2V/V \end{aligned}$$

##### Step 6

$$G_2 = 1 + (R_X/R_K) = 2.0$$

$$\therefore R_X/R_K = 1.0$$

$$\therefore R_X = R_K \quad (15)$$

##### Step 7

The resistance seen by the + input terminal of the output stage amplifier  $A_2$  (pin 13) is the output resistance 100k $\Omega$  of the output demodulator. The resistance seen by the (–) input terminal of  $A_2$  (pin 14) should be matched to the resistance seen by the + input terminal.

The resistance seen by pin 14 is the parallel combination of  $R_X$  and  $R_K$ .

$$\therefore R_X \parallel R_K = 100k\Omega$$

$$(R_X \cdot R_K)/(R_X + R_K) = 100k\Omega$$

$$R_K/[1 + (R_K/R_X)] = 100k\Omega \quad (16)$$

##### Step 8

Solving equations (15) and (16)  $R_K = 20k\Omega$  and  $R_X = 200k\Omega$ .

##### Step 9

The output demodulator must be loaded equal to the input demodulator.

$$\therefore R_B = R_A + R_F = 2M\Omega$$

(See equation (14) above in Step 2).

Use the resistor values obtained in Steps 3, 4, 8 and 9, and connect the 3656 as shown in Figure 3.

### OFFSET TRIMMING

Figure 5 shows an optional offset voltage trim circuit. It is important that  $R_A + R_F = R_B$ .

CASE 1: Input and output stages in low gain, use output potentiometer ( $R_2$ ) only. Input potentiometer ( $R_1$ ) may be disconnected. For example, unity gain could be obtained by setting  $R_A = R_B = 20M\Omega$ ,  $R_C = 100k\Omega$ ,  $R_F = 0$ ,  $R_X = 100k\Omega$ , and  $R_K = \infty$ .

CASE 2: Input stage in high gain and output stage in low gain, use input potentiometer ( $R_1$ ) only. Output potentiometer ( $R_2$ ) may be disconnected. For example,  $G_T = 100$  could be obtained by setting  $R_F = 2M\Omega$ ,  $R_B = 2M\Omega$  returned to pin 17,  $R_A = 20k\Omega$ ,  $R_X = 100k\Omega$ , and  $R_K = \infty$ .

CASE 3: When it is necessary to perform a two-stage precision trim (to maintain a very small offset change under conditions of changing temperature and changing gain in  $A_1$  and  $A_2$ ), use step 1 to adjust the input stage and step 2 for the output stage. Carbon composition resistors are acceptable, but potentiometers should be stable.

Step 1: Input stage trim ( $R_A = R_C = 20k\Omega$ ,  $R_1 = R_B = 20M\Omega$ ,  $R_X = 100k\Omega$ ,  $R_K = \infty$ ,  $R_2$  disconnected);  $A_1$  high,  $A_2$  low gain. Adjust  $R_1$  for 0V  $\pm$ 5mV or desired setting at  $V_{OUT}$ , pin 15.

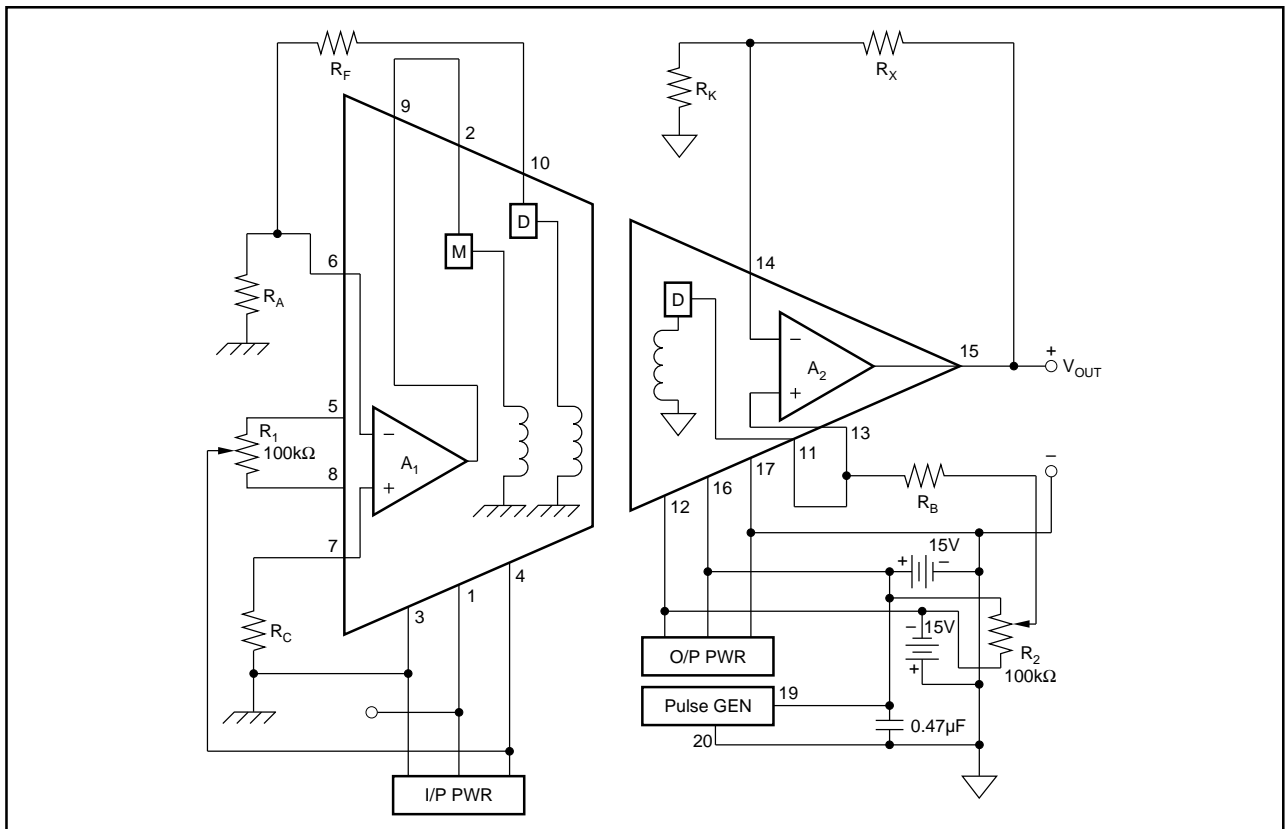

FIGURE 5. Optional Offset Voltage Trim.

Step 2: Output stage trim ( $R_A = R_B = 20\text{M}\Omega$ ,  $R_C = 100\text{k}\Omega$ ,  $R_F = 0$ ,  $R_X = 100\text{k}\Omega$ ,  $R_K = \infty$ ,  $R_1$  and  $R_2$  connected);  $A_1$  low,  $A_2$  low gain. Adjust  $R_2$  for  $0\text{V} \pm 1\text{mV}$  or desired setting at  $V_{\text{OUT}}$ , pin 15 ( $\pm 110\text{mV}$  approximate total range).

NOTE: Other circuit component values can be used with valid results.

## APPLICATIONS

### ECG AMPLIFIER

Although the features of the circuit shown in Figure 6 are important in patient monitoring applications, they may also be useful in other applications. The input circuitry uses an external, low quiescent current op amp (OPA177 type) powered by the isolated power of the input stage to form a high impedance instrumentation amplifier input (true three-wire input).  $R_3$  and  $R_4$  give the input stage amplifier of the 3656 a noninverting gain of 10 and an inverting gain of  $-9$ .  $R_1$  and  $R_2$  give the external amplifier a noninverting gain of  $1 + 1/9$ . The inputs are applied to the noninverting inputs of the two amplifiers and the composite input stage amplifier has a gain of 10.

The  $330\text{k}\Omega$ , 1W, carbon resistors and diodes  $D_1 - D_4$  provide protection for the input amplifiers from defibrillation pulses.

The output stage in Figure 6 is configured to provide a bandpass filter with a gain of 22.7 ( $68\text{M}\Omega/3\text{M}\Omega$ ). The high-

pass section (0.05Hz cutoff) is formed by the  $1\mu\text{F}$  capacitor and  $3\text{M}\Omega$  resistor which are connected in series between the output demodulator and the inverting input of the output stage amplifier. The low-pass section (100Hz cutoff) is formed by the  $68\text{M}\Omega$  resistor and  $22\text{pF}$  capacitor located in the feedback loop of the output stage. The diodes provide for quick recovery of the high-pass filter to overvoltages at the input. The  $100\text{k}\Omega$  pot and the  $100\text{M}\Omega$  resistor allow the output voltage to be trimmed to compensate for increased offset voltage caused by unbalanced impedances seen by the inputs of the output stage amplifier.

In many modern electrocardiographic systems, the patient is not grounded. Instead, the right-leg electrode is connected to the output of an auxiliary operational amplifier as shown in Figure 7. In this circuit, the common-mode voltage on the body is sensed by the two averaging resistors,  $R_1$  and  $R_2$ , inverted, amplified, and fed back to the right-leg through resistor  $R_4$ . This negative feedback drives the common-mode voltage to a low value. The body's displacement current  $i_d$  does not flow to ground, but rather to the output circuit of  $A_3$ . This reduces the pickup as far as the ECG amplifier is concerned and effectively grounds the patient.

The value of  $R_4$  should be as large as practical to isolate the patient from ground. The resistors  $R_3$  and  $R_4$  may be selected by these equations:

$$R_3 = (R_1/2) (V_O/V_{\text{CM}}) \text{ and } R_4 = (V_{\text{CM}} - V_O)/i_d$$

$$(-10\text{V} \leq V_O \leq +10\text{V} \text{ and } -10\text{V} \leq V_{\text{CM}} \leq +10\text{V})$$

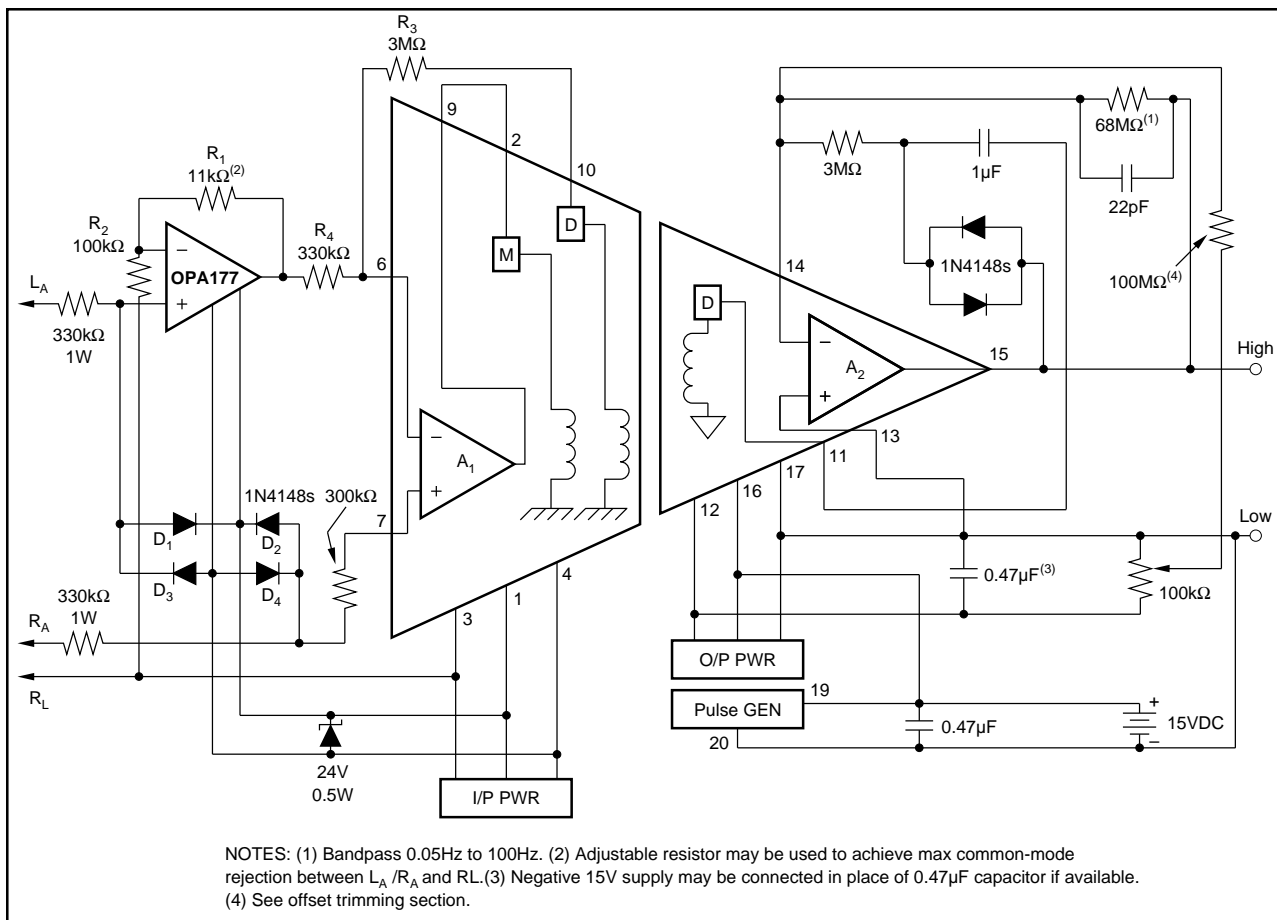

FIGURE 6. ECG Amplifier.

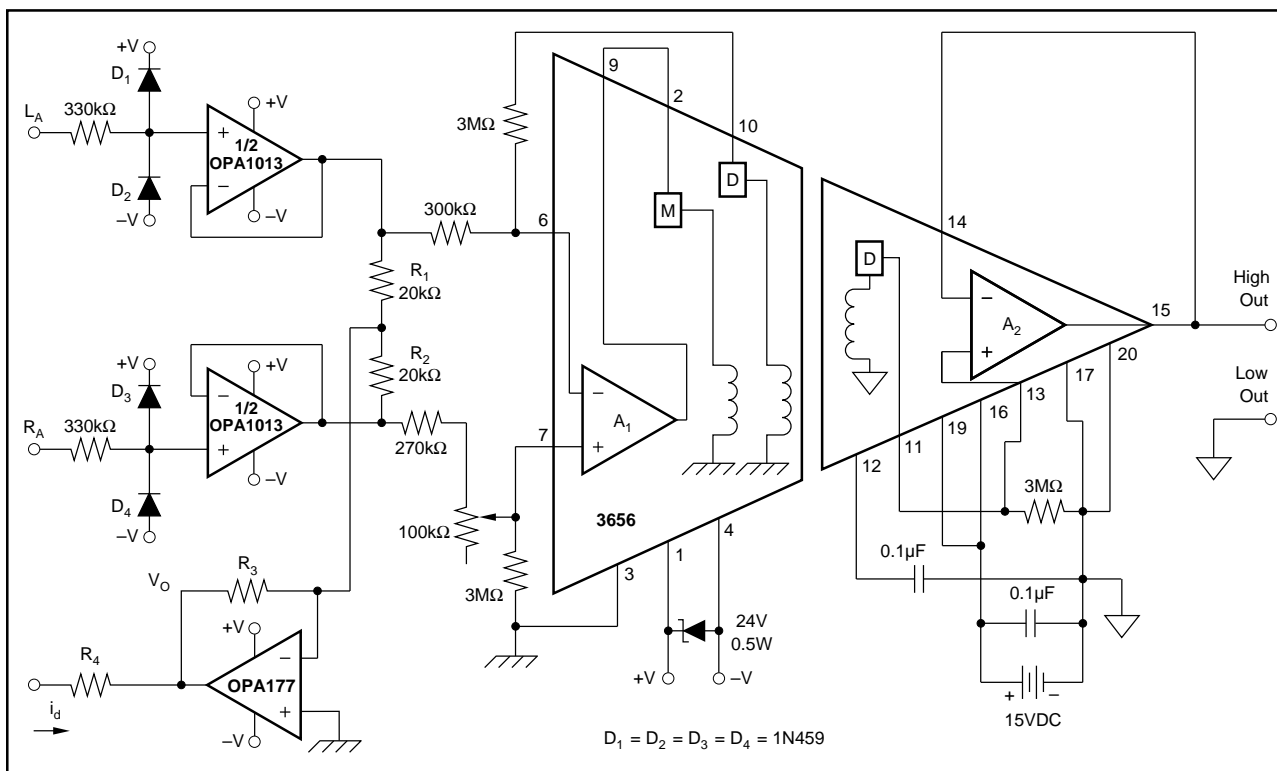

FIGURE 7. Driven Right-Leg Amplifier.

where  $V_O$  is the output voltage of  $A_3$ , and  $V_{CM}$  is the common-mode voltage between the inputs  $L_A$  and  $R_A$  and the input common at pin 3 of the 3656.

This circuit has the added benefit of having higher common-mode rejection than the circuit in Figure 6 (approximately 10dB improvement).

### BIPOLAR CURRENT OUTPUT

The three-port capability of the 3656 can be used to implement a current output isolation amplifier function—usually difficult to implement when grounded loads are involved. The circuit is shown in Figure 8 and the following equations apply:

$$G = I_{OUT}/V_{IN} = 1 + \frac{R_F}{R_A} \times \frac{R_2}{(R_1 + R_2) \cdot R_S}$$

$$I_{OUT} \leq \pm 2.5\text{mA}$$

$$V_1 \leq \pm 4\text{V (compliance)}$$

$$R_L \leq 1.6\text{k}\Omega$$

$$R_F + R_A = R_1 + R_2 \leq 2\text{M}\Omega$$

### CURRENT OUTPUT— LARGER UNIPOLAR CURRENTS

A more practical version of the current output function is shown in Figure 9. If the circuit is powered from a source greater than 15V as shown, a three-terminal regulator should

be used to provide 15V for the pulse generator (pins 19 and 20). The input stage is configured as a unity gain buffer, although other configurations such as current input could be used. The circuit uses the isolation feature between the output stage and the primary power supply to generate the output current configuration that can work into a grounded load. Note that the output transistors can only drive positive current into the load. Bipolar current output would require a second transistor and dual supply.

### ISOLATED 4mA TO 20mA OUTPUT

Figure 10 shows the circuit of an expanded version of the isolated current output function. It allows any input voltage range to generate the 4mA to 20mA output excursion and is also capable of zero suppression. The “span” (gain) is adjusted by  $R_2$  and the “zero” (4mA output for minimum input) is set by the 200kΩ pot in the output stage. A three-terminal 5V reference is used to provide a stable 4mA operating point. The reference is connected to insert an adjustable bias between the demodulator output and the noninverting input of the output stage.

### DIFFERENTIAL INPUT

Figure 11 shows the proper connections for differential input configuration. The 3656 is capable of operating in this input configuration only for floating loads (i.e., the source  $V_{IN}$  has no connection to the ground reference established at pin 3). For this configuration the usual 2MΩ resistor used in

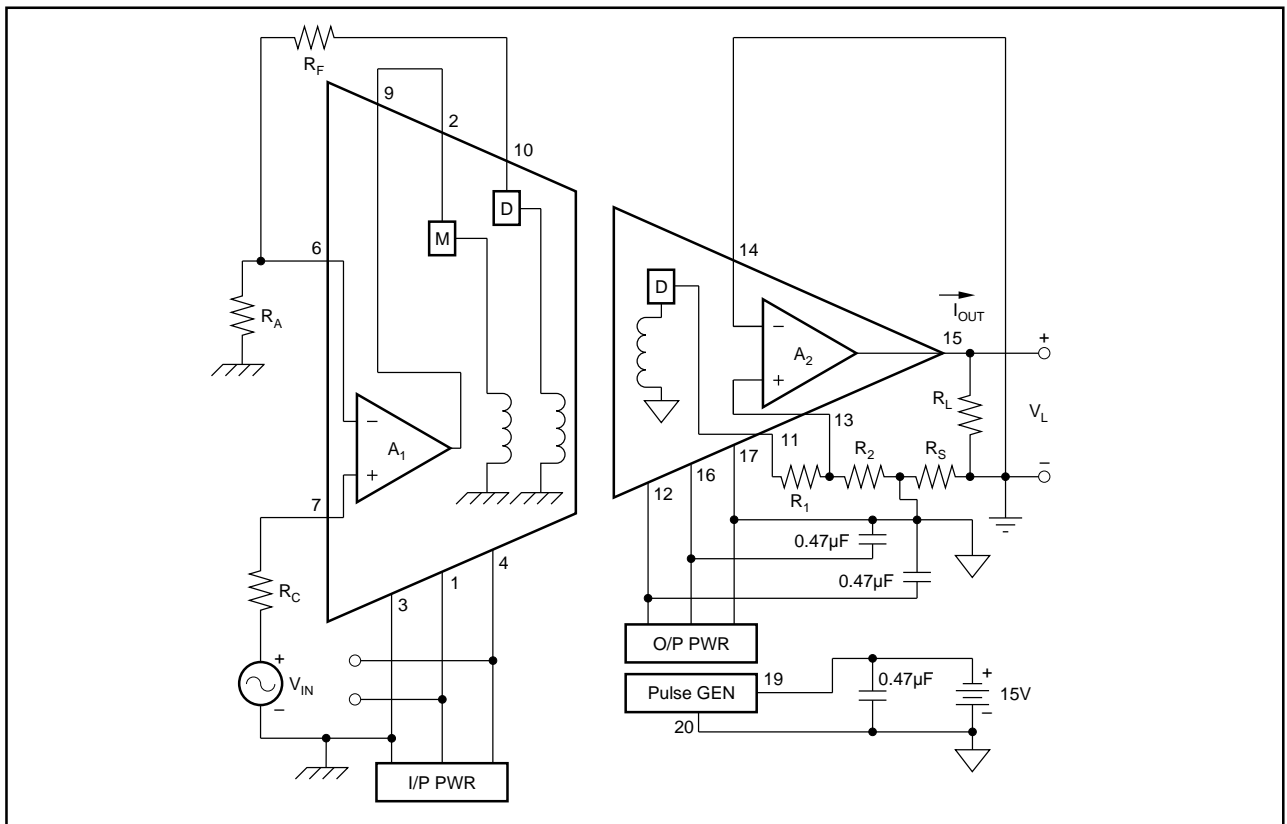

FIGURE 8. Bipolar Current Output.

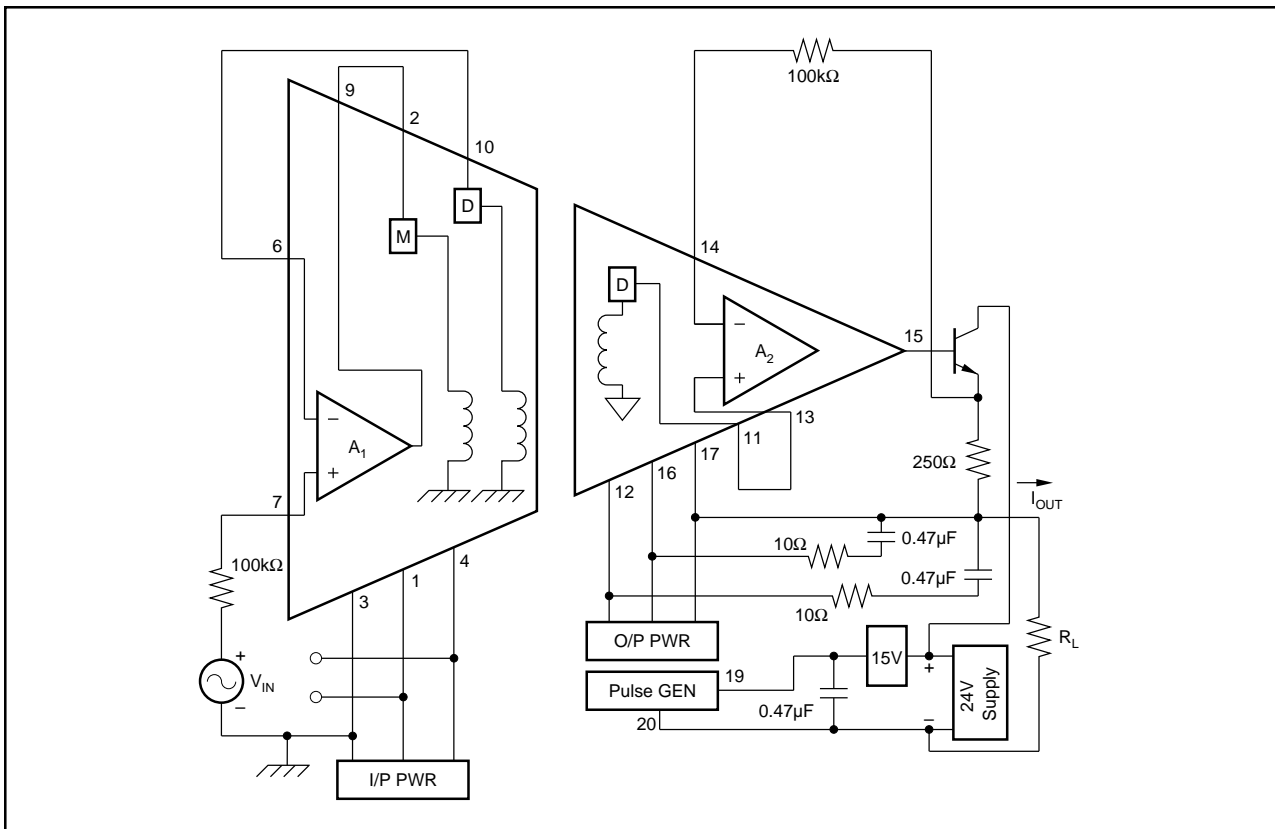

FIGURE 9. Isolated 1 to  $5V_{IN}$  / 4mA to 20mA  $I_{OUT}$ .

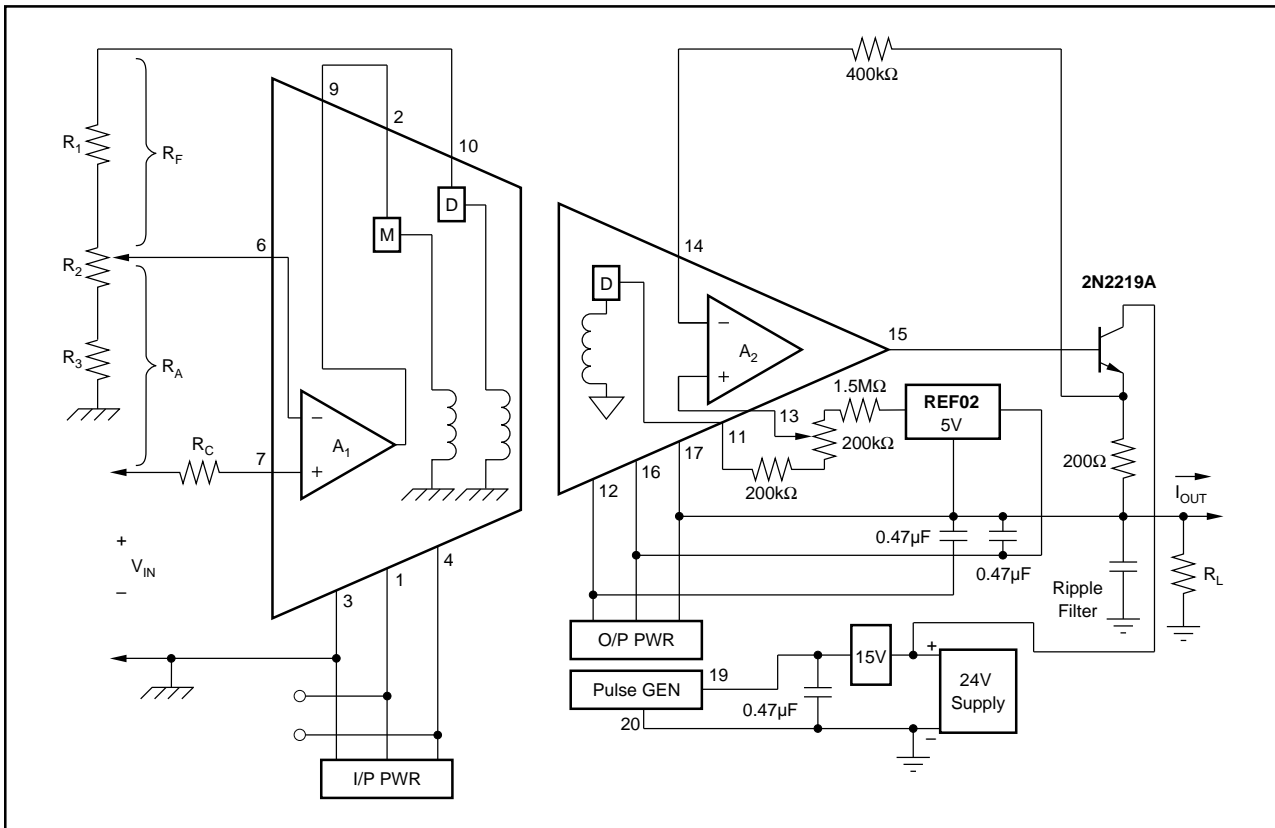

FIGURE 10. Isolated 4mA to 20mA  $I_{OUT}$ .

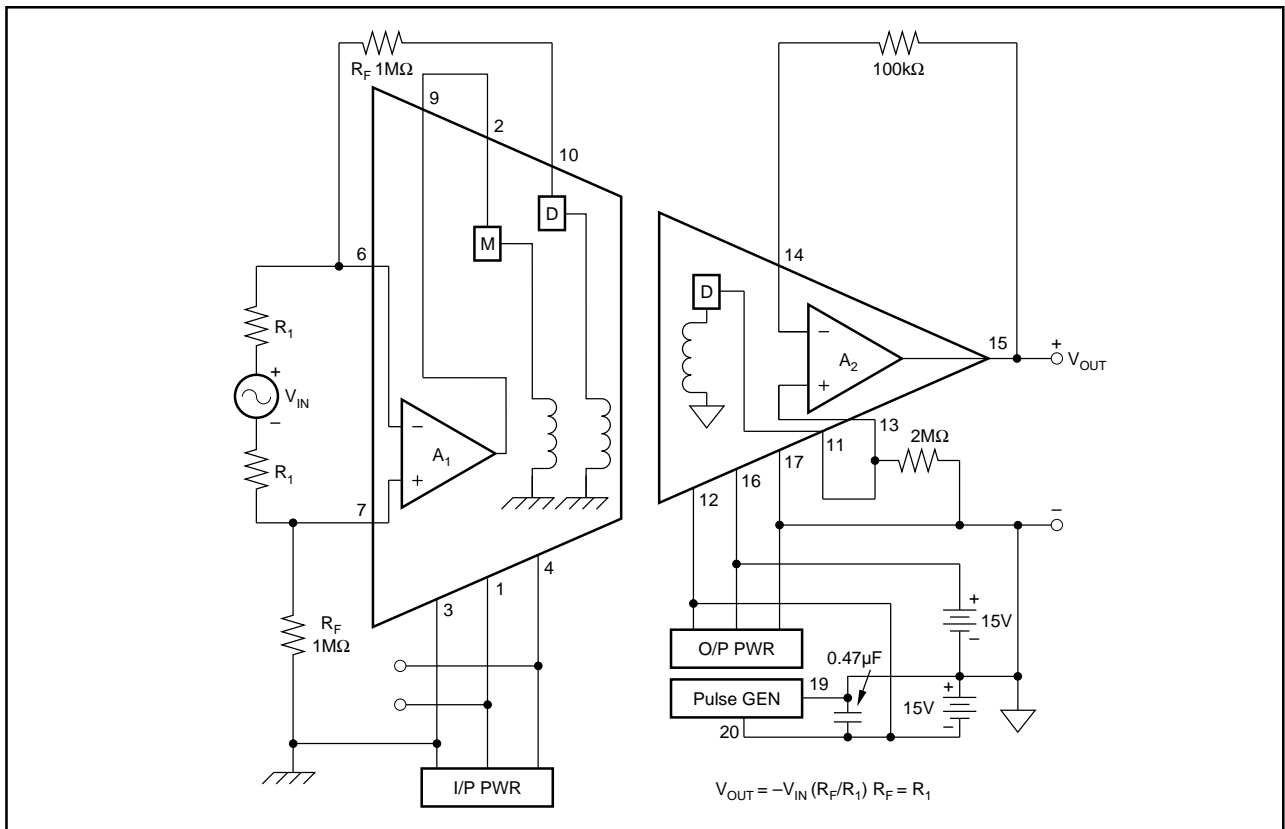

FIGURE 11. Differential Input, Floating Source.

the input stage is split into two halves,  $R_F$  and  $R_{F-}$ . The demodulator load (seen by pin 10 with respect to pin 3) is still  $2M\Omega$  for the floating load as shown. Notice pin 19 is common in Figure 11 whereas pin 20 is common in previous figures.

### SERIES STRING SOURCE

Figure 12 shows a situation where a small voltage, which is part of a series string of other voltages, must be measured. The basic problem is that the small voltage to be measured is 500V above the system ground (i.e., a system common-mode voltage of 500V exists). The circuit converts this system CMV to an amplifier isolation mode voltage. Thus, the isolation voltage ratings and isolation-mode rejection specifications apply.

### IMPROVED INPUT CHARACTERISTICS

In situations where it is desired to have better DC input amplifier characteristics than the 3656 normally provides, it is possible to add a precision operational amplifier as shown

in Figure 13. Here the instrumentation grade OPA177 is supplied from the isolated power of the input stage. The 3656 is configured as a unity-gain buffer. The gain of the OPA177 stage must be chosen to limit its full scale output voltage to 5V and avoid overdriving the 3656's demodulators. Since the 3656 draws a significant amount of supply current, extra filtering or the input supply is required as shown ( $2 \times 0.47\mu F$ ).

### ELECTROMAGNETIC RADIATION

The transformer coupling used in 3656 for isolation makes the 3656 a source of electromagnetic radiation unless it is properly shielded. Physical separation between the 3656 and sensitive components may not give sufficient attenuation by itself. In these applications, the use of an electromagnetic shield is a must. A shield, Burr-Brown 100MS, is specially designed for use with the 3656 package. Note that the offset voltage appearing at pin 15 may change by 4mV to 12mV with use of the shield; however, this can be trimmed (see Offset Trimming section).

The information provided herein is believed to be reliable; however, BURR-BROWN assumes no responsibility for inaccuracies or omissions. BURR-BROWN assumes no responsibility for the use of this information, and all use of such information shall be entirely at the user's own risk. Prices and specifications are subject to change without notice. No patent rights or licenses to any of the circuits described herein are implied or granted to any third party. BURR-BROWN does not authorize or warrant any BURR-BROWN product for use in life support devices and/or systems.

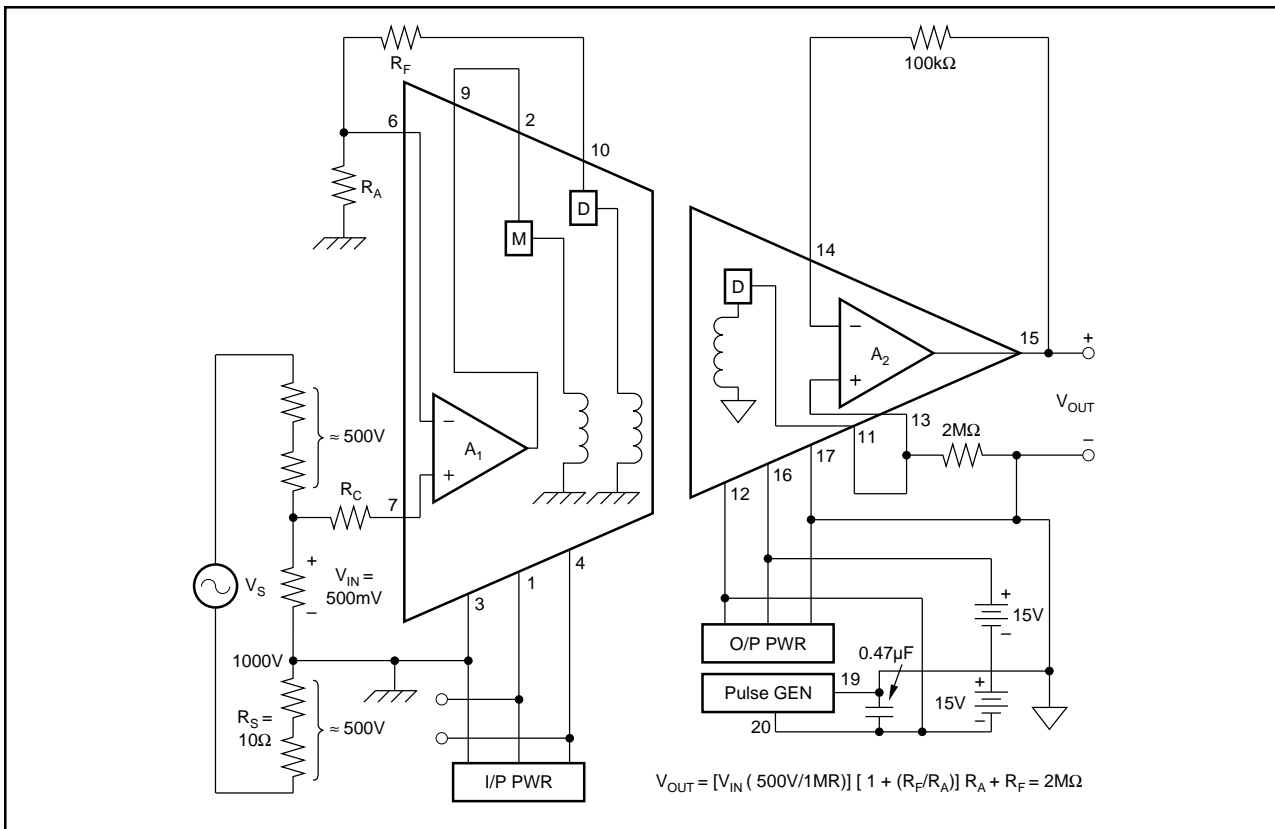

FIGURE 12. Series Source.

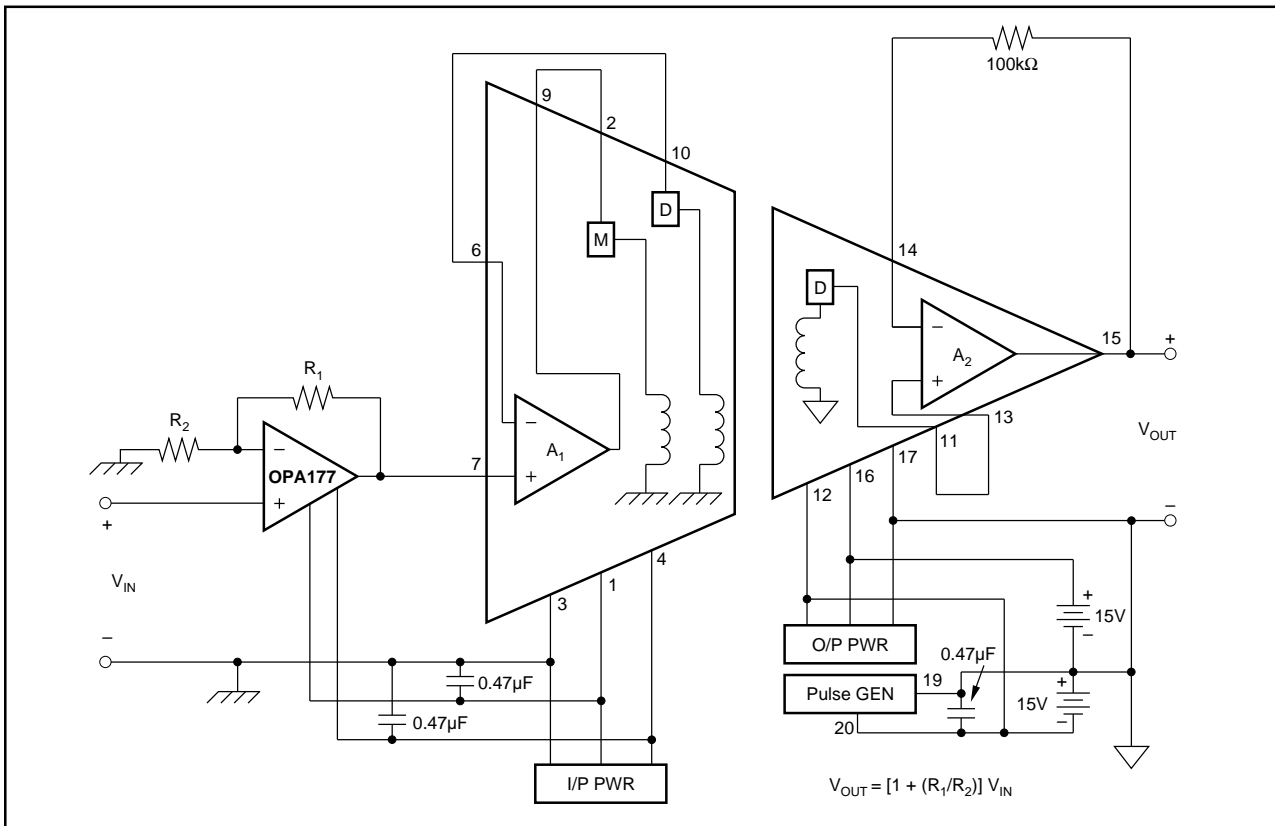

FIGURE 13. Isolator for Low-Level Signals.



**PACKAGING INFORMATION**

| ORDERABLE DEVICE | STATUS(1) | PACKAGE TYPE | PACKAGE DRAWING | PINS | PACKAGE QTY |
|------------------|-----------|--------------|-----------------|------|-------------|
| 3656AG           | NRND      | CDIP         | JND             | 20   | 17          |
| 3656BG           | NRND      | CDIP         | JND             | 20   | 17          |
| 3656HG           | NRND      | CDIP         | JND             | 20   | 17          |
| 3656JG           | NRND      | CDIP         | JND             | 20   | 17          |
| 3656KG           | NRND      | CDIP         | JND             | 20   | 17          |

(1) The marketing status values are defined as follows:

**ACTIVE:** Product device recommended for new designs.

**LIFEBUY:** TI has announced that the device will be discontinued, and a lifetime-buy period is in effect.

**NRND:** Not recommended for new designs. Device is in production to support existing customers, but TI does not recommend using this part in a new design.

**PREVIEW:** Device has been announced but is not in production. Samples may or may not be available.

**OBSOLETE:** TI has discontinued the production of the device.

---

## IMPORTANT NOTICE

Texas Instruments Incorporated and its subsidiaries (TI) reserve the right to make corrections, modifications, enhancements, improvements, and other changes to its products and services at any time and to discontinue any product or service without notice. Customers should obtain the latest relevant information before placing orders and should verify that such information is current and complete. All products are sold subject to TI's terms and conditions of sale supplied at the time of order acknowledgment.

TI warrants performance of its hardware products to the specifications applicable at the time of sale in accordance with TI's standard warranty. Testing and other quality control techniques are used to the extent TI deems necessary to support this warranty. Except where mandated by government requirements, testing of all parameters of each product is not necessarily performed.

TI assumes no liability for applications assistance or customer product design. Customers are responsible for their products and applications using TI components. To minimize the risks associated with customer products and applications, customers should provide adequate design and operating safeguards.

TI does not warrant or represent that any license, either express or implied, is granted under any TI patent right, copyright, mask work right, or other TI intellectual property right relating to any combination, machine, or process in which TI products or services are used. Information published by TI regarding third-party products or services does not constitute a license from TI to use such products or services or a warranty or endorsement thereof. Use of such information may require a license from a third party under the patents or other intellectual property of the third party, or a license from TI under the patents or other intellectual property of TI.

Reproduction of information in TI data books or data sheets is permissible only if reproduction is without alteration and is accompanied by all associated warranties, conditions, limitations, and notices. Reproduction of this information with alteration is an unfair and deceptive business practice. TI is not responsible or liable for such altered documentation.

Resale of TI products or services with statements different from or beyond the parameters stated by TI for that product or service voids all express and any implied warranties for the associated TI product or service and is an unfair and deceptive business practice. TI is not responsible or liable for any such statements.

Following are URLs where you can obtain information on other Texas Instruments products and application solutions:

| <b>Products</b>  |  | <b>Applications</b> |  |
|------------------|--|---------------------|--|
| Amplifiers       | <a href="http://amplifier.ti.com">amplifier.ti.com</a>             | Audio               | <a href="http://www.ti.com/audio">www.ti.com/audio</a>                   |
| Data Converters  | <a href="http://dataconverter.ti.com">dataconverter.ti.com</a>     | Automotive          | <a href="http://www.ti.com/automotive">www.ti.com/automotive</a>         |
| DSP              | <a href="http://dsp.ti.com">dsp.ti.com</a>                         | Broadband           | <a href="http://www.ti.com/broadband">www.ti.com/broadband</a>           |
| Interface        | <a href="http://interface.ti.com">interface.ti.com</a>             | Digital Control     | <a href="http://www.ti.com/digitalcontrol">www.ti.com/digitalcontrol</a> |
| Logic            | <a href="http://logic.ti.com">logic.ti.com</a>                     | Military            | <a href="http://www.ti.com/military">www.ti.com/military</a>             |
| Power Mgmt       | <a href="http://power.ti.com">power.ti.com</a>                     | Optical Networking  | <a href="http://www.ti.com/opticalnetwork">www.ti.com/opticalnetwork</a> |
| Microcontrollers | <a href="http://microcontroller.ti.com">microcontroller.ti.com</a> | Security            | <a href="http://www.ti.com/security">www.ti.com/security</a>             |
|                  |  | Telephony           | <a href="http://www.ti.com/telephony">www.ti.com/telephony</a>           |
|                  |  | Video & Imaging     | <a href="http://www.ti.com/video">www.ti.com/video</a>                   |
|                  |  | Wireless            | <a href="http://www.ti.com/wireless">www.ti.com/wireless</a>             |

Mailing Address: Texas Instruments  
Post Office Box 655303 Dallas, Texas 75265

Copyright © 2003, Texas Instruments Incorporated