

LM137HV/LM337HV 3-Terminal Adjustable Negative Regulators (High Voltage)

Check for Samples: [LM137HV](#), [LM337HV](#)

FEATURES

- Output Voltage Adjustable from -1.2V to -47V
- 1.5A Output Current Specified, -55°C to $+150^{\circ}\text{C}$
- Line Regulation Typically 0.01%/V
- Load Regulation Typically 0.3%
- Excellent Thermal Regulation, 0.002%/W
- 77 dB Ripple Rejection
- Excellent Rejection of Thermal Transients
- 50 ppm/ $^{\circ}\text{C}$ Temperature Coefficient
- Temperature-Independent Current Limit
- Internal Thermal Overload Protection
- P⁺ Product Enhancement tested
- Standard 3-Lead Transistor Package
- Output Short Circuit Protected

DESCRIPTION

The LM137HV/LM337HV are adjustable 3-terminal negative voltage regulators capable of supplying in excess of -1.5A over an output voltage range of -1.2V to -47V . These regulators are exceptionally easy to apply, requiring only 2 external resistors to set the output voltage and 1 output capacitor for frequency compensation. The circuit design has been optimized for excellent regulation and low thermal transients. Further, the LM137HV series features internal current limiting, thermal shutdown and safe-area compensation, making them virtually blowout-proof against overloads.

The LM137HV/LM337HV serve a wide variety of applications including local on-card regulation, programmable-output voltage regulation or precision current regulation. The LM137HV/LM337HV are ideal complements to the LM117HV/LM317HV adjustable positive regulators.

Connection Diagram

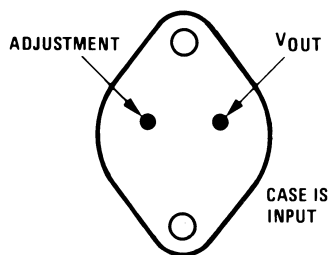

**Figure 1. TO-3
Bottom View**
See Package Number K0002C
See Package Number NDS0002A

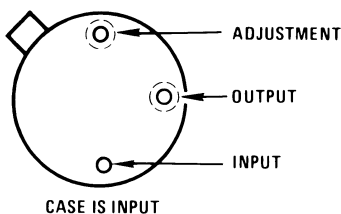

**Figure 2. TO
Bottom View**
See Package Number NDT0003A



Please be aware that an important notice concerning availability, standard warranty, and use in critical applications of Texas Instruments semiconductor products and disclaimers thereto appears at the end of this data sheet.

All trademarks are the property of their respective owners.

Typical Applications

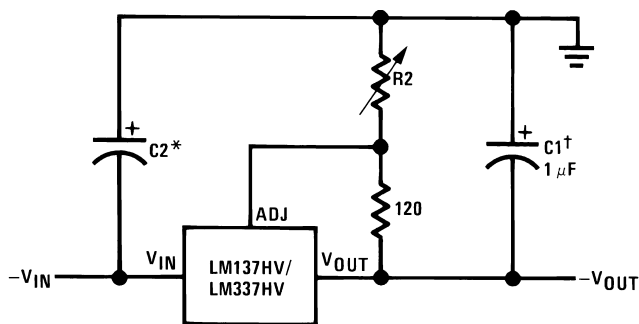

$$-V_{OUT} = -1.25V \left(1 + \frac{R_2}{120\Omega} \right) + \left[-I_{Adj}(R_2) \right]$$

†C1 = 1 μF solid tantalum or 10 μF aluminum electrolytic required for stability. Output capacitors in the range of 1 μF to 1000 μF of aluminum or tantalum electrolytic are commonly used to provide improved output impedance and rejection of transients.

*C2 = 1 μF solid tantalum is required only if regulator is more than 4" from power-supply filter capacitor.

Figure 3. Adjustable Negative Voltage Regulator



These devices have limited built-in ESD protection. The leads should be shorted together or the device placed in conductive foam during storage or handling to prevent electrostatic damage to the MOS gates.

ABSOLUTE MAXIMUM RATINGS⁽¹⁾⁽²⁾⁽³⁾

Power Dissipation		Internally limited
Input–Output Voltage Differential		50V
Operating Junction Temperature Range	LM137HV	-55°C to +150°C
	LM337HV	0°C to +125°C
Storage Temperature		-65°C to +150°C
Lead Temperature (Soldering, 10 sec.)		300°
ESD rating is to be determined.		

- (1) "Absolute Maximum Ratings" indicate limits beyond which damage to the device may occur. Operating Ratings indicate conditions for which the device is functional, but do not ensure specific performance limits.
- (2) Refer to RETS137HVH drawing for LM137HVH or RETS137HVK for LM137HVK military specifications.
- (3) If Military/Aerospace specified devices are required, please contact the TI Sales Office/ Distributors for availability and specifications.

ELECTRICAL CHARACTERISTICS⁽¹⁾

Parameter	Conditions	LM137HV			LM337HV			Units
		Min	Typ	Max	Min	Typ	Max	
Line Regulation	$T_J = 25^\circ\text{C}$, $3V \leq V_{IN} - V_{OUT} \leq 50V$, ⁽²⁾ $I_L = 10\text{ mA}$		0.01	0.02		0.01	0.04	%/V
Load Regulation	$T_J = 25^\circ\text{C}$, $10\text{ mA} \leq I_{OUT} \leq I_{MAX}$		0.3	0.5		0.3	1.0	%
Thermal Regulation	$T_J = 25^\circ\text{C}$, 10 ms Pulse		0.002	0.02		0.003	0.04	%/W
Adjustment Pin Current			65	100		65	100	μA
Adjustment Pin Current Change	$10\text{ mA} \leq I_L \leq I_{MAX}$		2	5		2	5	μA
	$3.0V \leq V_{IN} - V_{OUT} \leq 50V$, $T_J = 25^\circ$		4	6		3	6	μA

- (1) Unless otherwise specified, these specifications apply: $-55^\circ\text{C} \leq T_J \leq +150^\circ\text{C}$ for the LM137HV, $0^\circ\text{C} \leq T_J \leq +125^\circ\text{C}$ for the LM337HV; $V_{IN} - V_{OUT} = 5V$; and $I_{OUT} = 0.1A$ for the TO package and $I_{OUT} = 0.5A$ for the TO-3 package. Although power dissipation is internally limited, these specifications are applicable for power dissipations of 2W for the TO and 20W for the TO-3. I_{MAX} is 1.5A for the TO-3 package and 0.2A for the TO package.
- (2) Regulation is measured at constant junction temperature, using pulse testing with a low duty cycle. Changes in output voltage due to heating effects are covered under the specification for thermal regulations. Load regulation is measured on the output pin at a point 1/8" below the base of the TO-3 and TO packages.

ELECTRICAL CHARACTERISTICS⁽¹⁾ (continued)

Parameter	Conditions	LM137HV			LM337HV			Units
		Min	Typ	Max	Min	Typ	Max	
Reference Voltage	$T_J = 25^\circ\text{C}$, ⁽³⁾ $3\text{V} \leq V_{\text{IN}} - V_{\text{OUT}} \leq 50\text{V}$, ⁽³⁾ $10\text{ mA} \leq I_{\text{OUT}} \leq I_{\text{MAX}}$, $P \leq P_{\text{MAX}}$	-1.225	-1.250	-1.275	-1.213	-1.250	-1.287	V
		-1.200	-1.250	-1.300	-1.200	-1.250	-1.300	V
Line Regulation	$3\text{V} \leq V_{\text{IN}} - V_{\text{OUT}} \leq 50\text{V}$, ⁽²⁾ $I_L = 10\text{ mA}$		0.02	0.05		0.02	0.07	%/V
Load Regulation	$10\text{ mA} \leq I_{\text{OUT}} \leq I_{\text{MAX}}$, ⁽²⁾		0.3	1		0.3	1.5	%
Temperature Stability	$T_{\text{MIN}} \leq T_J \leq T_{\text{MAX}}$		0.6			0.6		%
Minimum Load Current	$ V_{\text{IN}} - V_{\text{OUT}} \leq 50\text{V}$ $ V_{\text{IN}} - V_{\text{OUT}} \leq 10\text{V}$		2.5	5		2.5	10	mA
			1.2	3		1.5	6	mA
Current Limit	$ V_{\text{IN}} - V_{\text{OUT}} \leq 13\text{V}$ K Package	1.5	2.2	3.2	1.5	2.2	3.5	A
		0.5	0.8	1.6	0.5	0.8	1.8	A
	$ V_{\text{IN}} - V_{\text{OUT}} = 50\text{V}$ K Package	0.2	0.4	0.8	0.1	0.4	0.8	A
		0.1	0.17	0.5	0.050	0.17	0.5	A
RMS Output Noise, % of V_{OUT}	$T_J = 25^\circ\text{C}$, $10\text{ Hz} \leq f \leq 10\text{ kHz}$		0.003			0.003		%
Ripple Rejection Ratio	$V_{\text{OUT}} = -10\text{V}$, $f = 120\text{ Hz}$ $C_{\text{ADJ}} = 10\text{ }\mu\text{F}$		60			60		dB
		66	77		66	77		dB
Long-Term Stability	$T_A = 125^\circ\text{C}$, 1000 Hours		0.3	1		0.3	1	%
Thermal Resistance, Junction to Case	H Package		12	15		12	15	$^\circ\text{C/W}$
	K Package		2.3	3		2.3	3	$^\circ\text{C/W}$
Thermal Resistance, Junction to Ambient	H Package		140			140		$^\circ\text{C/W}$
	K Package		35			35		$^\circ\text{C/W}$

(3) Refer to RETS137HVH drawing for LM137HVH or RETS137HVK for LM137HVK military specifications.

SCHEMATIC DIAGRAM

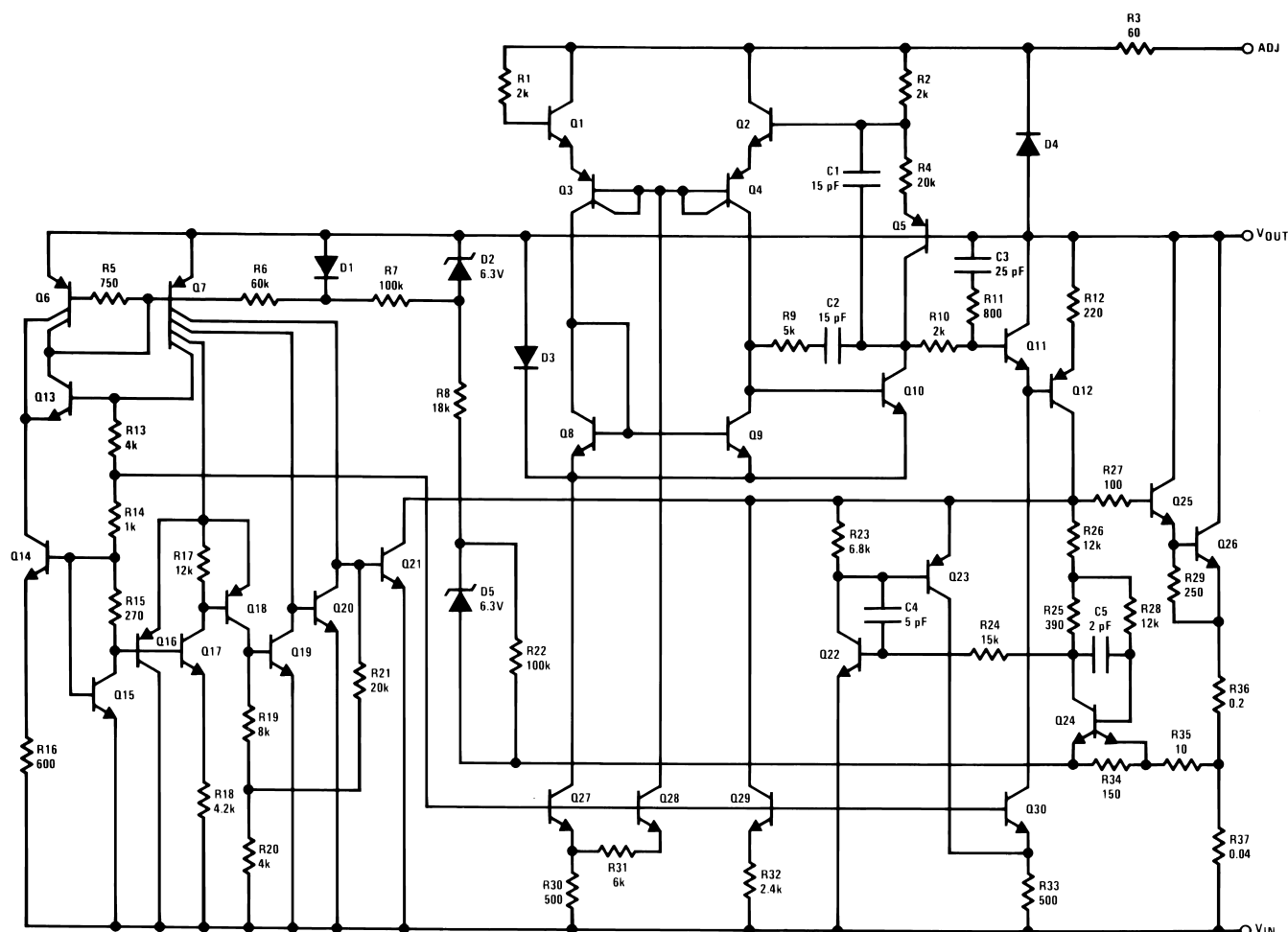
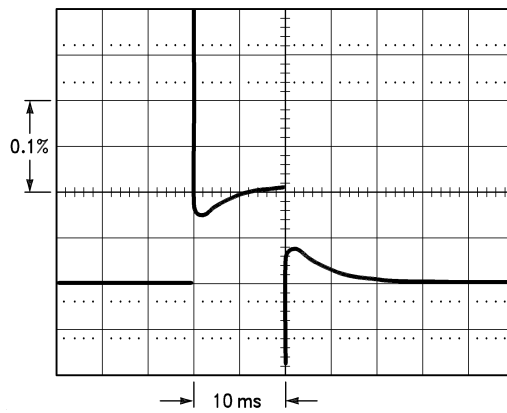

Figure 4. Schematic Diagram

Thermal Regulation

When power is dissipated in an IC, a temperature gradient occurs across the IC chip affecting the individual IC circuit components. With an IC regulator, this gradient can be especially severe since power dissipation is large. Thermal regulation is the effect of these temperature gradients on output voltage (in percentage output change) per Watt of power change in a specified time. Thermal regulation error is independent of electrical regulation or temperature coefficient, and occurs within 5 ms to 50 ms after a change in power dissipation. Thermal regulation depends on IC layout as well as electrical design. The thermal regulation of a voltage regulator is defined as the percentage change of V_{OUT} , per Watt, within the first 10 ms after a step of power is applied. The LM137HV's specification is 0.02%/W, max.

In [Figure 5](#), a typical LM137HV's output drifts only 3 mV (or 0.03% of $V_{OUT} = -10V$) when a 10W pulse is applied for 10 ms. This performance is thus well inside the specification limit of $0.02\%/W \times 10W = 0.2\%$ max. When the 10W pulse is ended, the thermal regulation again shows a 3 mV step as the LM137HV chip cools off. Note that the load regulation error of about 8 mV (0.08%) is additional to the thermal regulation error. In [Figure 6](#), when the 10W pulse is applied for 100 ms, the output drifts only slightly beyond the drift in the first 10 ms, and the thermal error stays well within 0.1% (10 mV).



LM137HV, $V_{OUT} = -10V$
 $V_{IN} - V_{OUT} = -40V$
 $I_L = 0A \rightarrow 0.25A \rightarrow 0A$
 Vertical sensitivity, 5 mV/div

Figure 5.

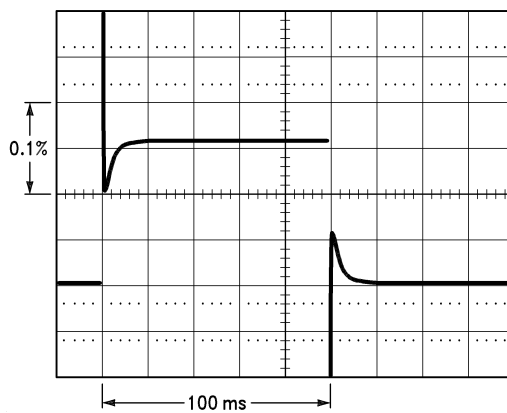

LM137HV, $V_{OUT} = -10V$
 $V_{IN} - V_{OUT} = -40V$
 $I_L = 0A \rightarrow 0.25A \rightarrow 0A$
 Horizontal sensitivity, 20 ms/div

Figure 6.

TYPICAL APPLICATIONS

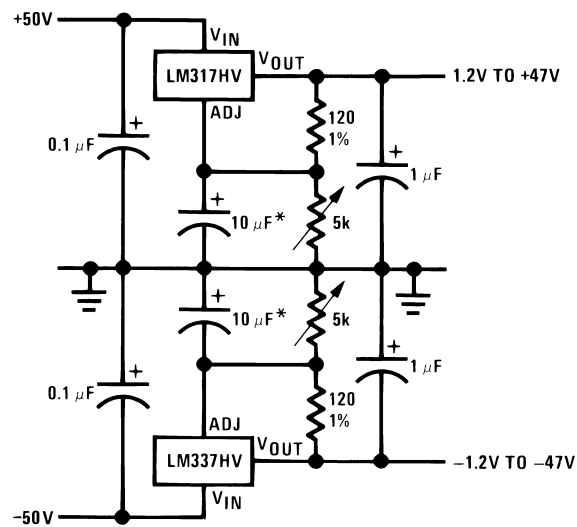

Full output current not available at high input-output voltages

*The 10 μF capacitors are optional to improve ripple rejection

Figure 7. Adjustable High Voltage Regulator

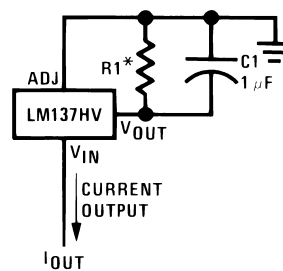

$$I_{\text{OUT}} = \frac{V_{\text{REF}}}{R_1}$$

$$* 0.8\Omega \leq R_1 \leq 120\Omega$$

Figure 8. Current Regulator

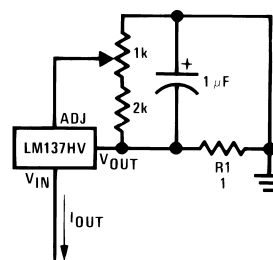

$$I_{\text{OUT}} = \left(\frac{1.5\text{V}}{R_1} \right) \pm 15\% \text{ adjustable}$$

Figure 9. Adjustable Current Regulator

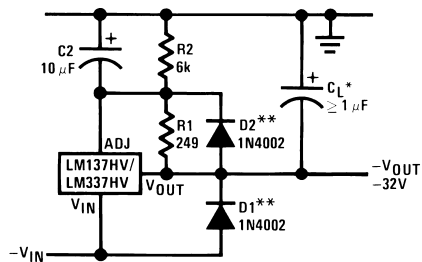

*When C_L is larger than 20 μF , D1 protects the LM137HV in case the input supply is shorted
 **When C_2 is larger than 10 μF and $-V_{\text{OUT}}$ is larger than -25V, D2 protects the LM137HV in case the output is shorted

Figure 10. Negative Regulator with Protection Diodes

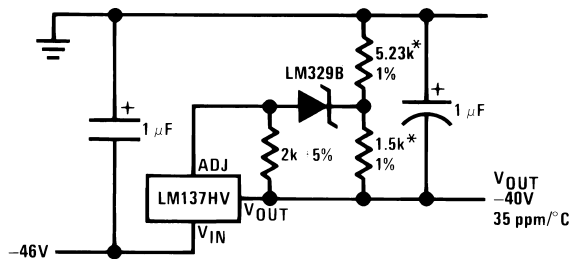

*Use resistors with good tracking TC < 25 ppm/°C

Figure 11. High Stability -40V Regulator

TYPICAL PERFORMANCE CHARACTERISTICS

(H and K-STEEL Package)

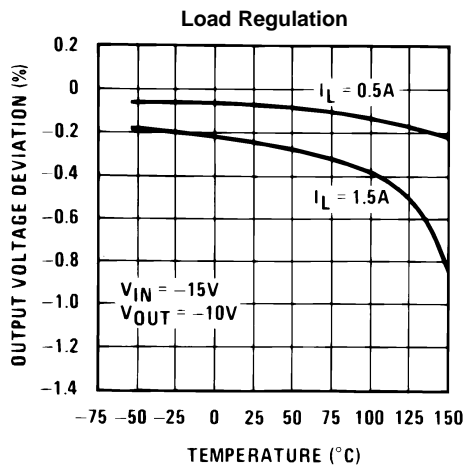

Figure 12.

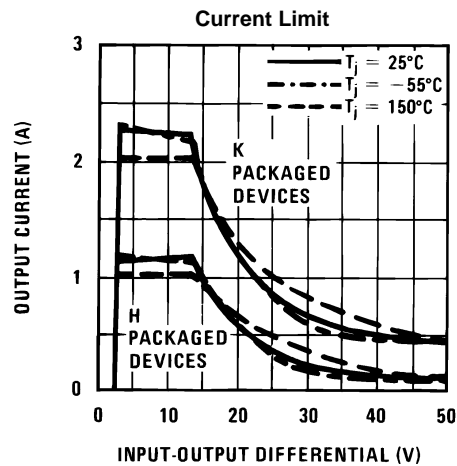

Figure 13.

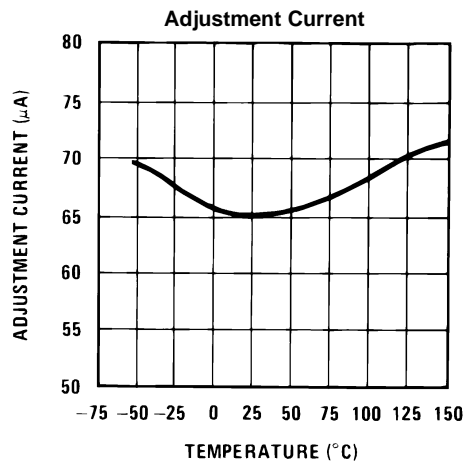

Figure 14.

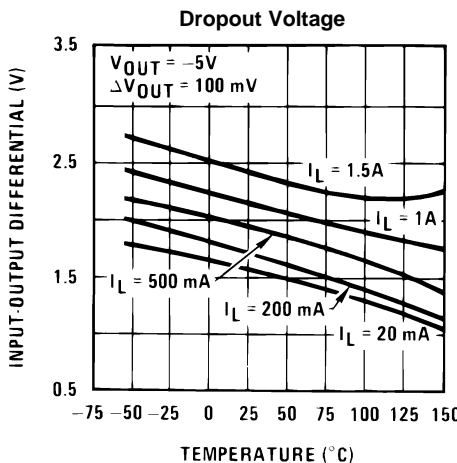

Figure 15.

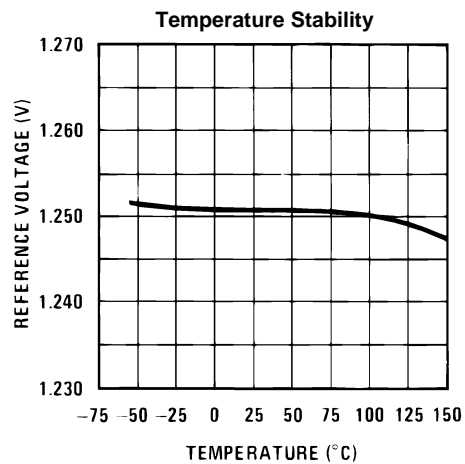

Figure 16.

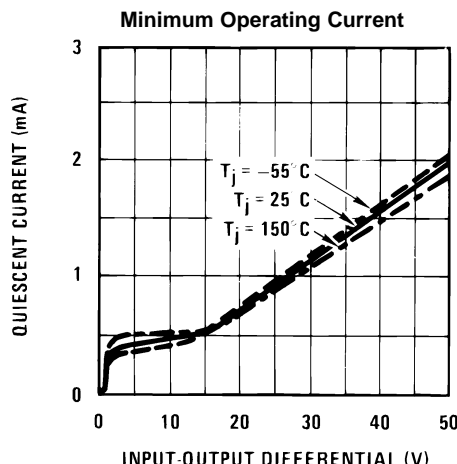

Figure 17.

TYPICAL PERFORMANCE CHARACTERISTICS (continued)

(H and K-STEEL Package)

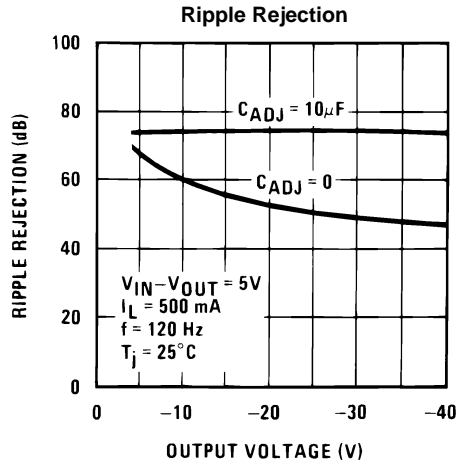

Figure 18.

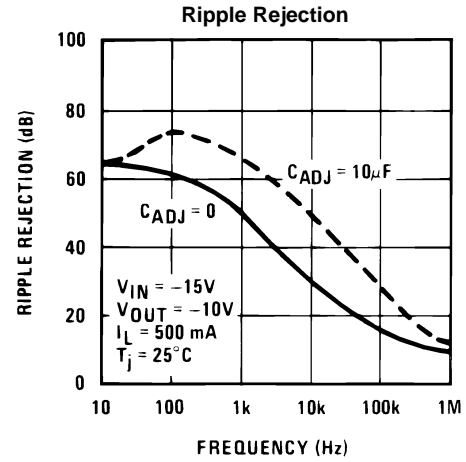

Figure 19.

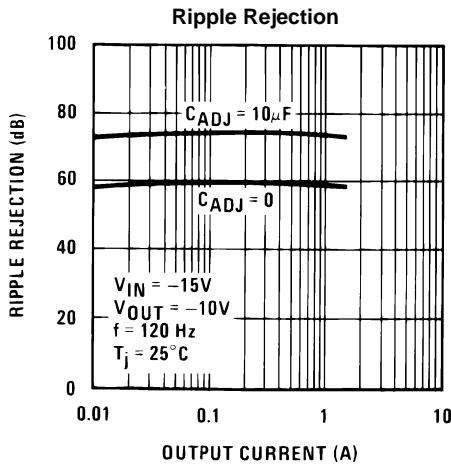

Figure 20.

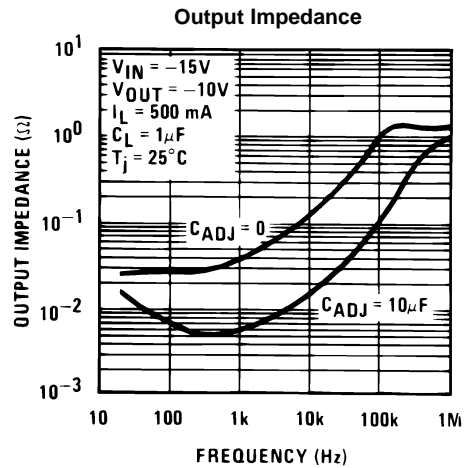

Figure 21.

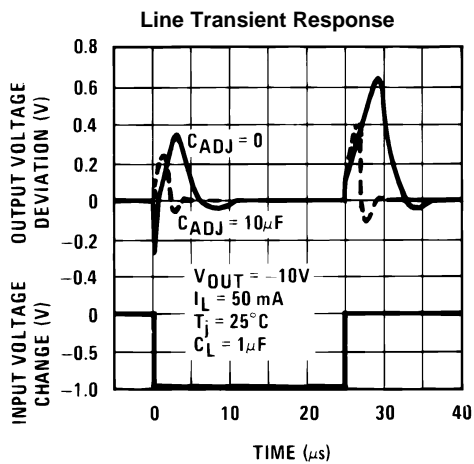

Figure 22.

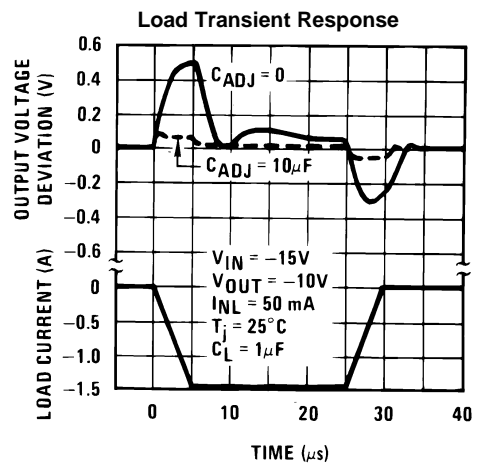

Figure 23.

REVISION HISTORY

Changes from Revision C (April 2013) to Revision D	Page
• Changed layout of National Data Sheet to TI format	9

IMPORTANT NOTICE

Texas Instruments Incorporated and its subsidiaries (TI) reserve the right to make corrections, enhancements, improvements and other changes to its semiconductor products and services per JESD46, latest issue, and to discontinue any product or service per JESD48, latest issue. Buyers should obtain the latest relevant information before placing orders and should verify that such information is current and complete. All semiconductor products (also referred to herein as "components") are sold subject to TI's terms and conditions of sale supplied at the time of order acknowledgment.

TI warrants performance of its components to the specifications applicable at the time of sale, in accordance with the warranty in TI's terms and conditions of sale of semiconductor products. Testing and other quality control techniques are used to the extent TI deems necessary to support this warranty. Except where mandated by applicable law, testing of all parameters of each component is not necessarily performed.

TI assumes no liability for applications assistance or the design of Buyers' products. Buyers are responsible for their products and applications using TI components. To minimize the risks associated with Buyers' products and applications, Buyers should provide adequate design and operating safeguards.

TI does not warrant or represent that any license, either express or implied, is granted under any patent right, copyright, mask work right, or other intellectual property right relating to any combination, machine, or process in which TI components or services are used. Information published by TI regarding third-party products or services does not constitute a license to use such products or services or a warranty or endorsement thereof. Use of such information may require a license from a third party under the patents or other intellectual property of the third party, or a license from TI under the patents or other intellectual property of TI.

Reproduction of significant portions of TI information in TI data books or data sheets is permissible only if reproduction is without alteration and is accompanied by all associated warranties, conditions, limitations, and notices. TI is not responsible or liable for such altered documentation. Information of third parties may be subject to additional restrictions.

Resale of TI components or services with statements different from or beyond the parameters stated by TI for that component or service voids all express and any implied warranties for the associated TI component or service and is an unfair and deceptive business practice. TI is not responsible or liable for any such statements.

Buyer acknowledges and agrees that it is solely responsible for compliance with all legal, regulatory and safety-related requirements concerning its products, and any use of TI components in its applications, notwithstanding any applications-related information or support that may be provided by TI. Buyer represents and agrees that it has all the necessary expertise to create and implement safeguards which anticipate dangerous consequences of failures, monitor failures and their consequences, lessen the likelihood of failures that might cause harm and take appropriate remedial actions. Buyer will fully indemnify TI and its representatives against any damages arising out of the use of any TI components in safety-critical applications.

In some cases, TI components may be promoted specifically to facilitate safety-related applications. With such components, TI's goal is to help enable customers to design and create their own end-product solutions that meet applicable functional safety standards and requirements. Nonetheless, such components are subject to these terms.

No TI components are authorized for use in FDA Class III (or similar life-critical medical equipment) unless authorized officers of the parties have executed a special agreement specifically governing such use.

Only those TI components which TI has specifically designated as military grade or "enhanced plastic" are designed and intended for use in military/aerospace applications or environments. Buyer acknowledges and agrees that any military or aerospace use of TI components which have **not** been so designated is solely at the Buyer's risk, and that Buyer is solely responsible for compliance with all legal and regulatory requirements in connection with such use.

TI has specifically designated certain components as meeting ISO/TS16949 requirements, mainly for automotive use. In any case of use of non-designated products, TI will not be responsible for any failure to meet ISO/TS16949.

Products

Audio	www.ti.com/audio
Amplifiers	amplifier.ti.com
Data Converters	dataconverter.ti.com
DLP® Products	www.dlp.com
DSP	dsp.ti.com
Clocks and Timers	www.ti.com/clocks
Interface	interface.ti.com
Logic	logic.ti.com
Power Mgmt	power.ti.com
Microcontrollers	microcontroller.ti.com
RFID	www.ti-rfid.com
OMAP Applications Processors	www.ti.com/omap
Wireless Connectivity	www.ti.com/wirelessconnectivity

Applications

Automotive and Transportation	www.ti.com/automotive
Communications and Telecom	www.ti.com/communications
Computers and Peripherals	www.ti.com/computers
Consumer Electronics	www.ti.com/consumer-apps
Energy and Lighting	www.ti.com/energy
Industrial	www.ti.com/industrial
Medical	www.ti.com/medical
Security	www.ti.com/security
Space, Avionics and Defense	www.ti.com/space-avionics-defense
Video and Imaging	www.ti.com/video

TI E2E Community

e2e.ti.com