



GL10-R3812

G10

SMALL PHOTOELECTRIC SENSORS

SICK
Sensor Intelligence.



Illustration may differ

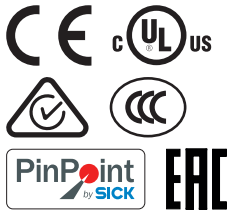

Ordering information

| Type | Part no. |
|------------|----------|
| GL10-R3812 | 1065898 |

Included in delivery: P250 (1), BEF-G10UC01 (1)

Other models and accessories → www.sick.com/G10

Detailed technical data

Features

| | |
|--|--|
| Device type | Photoelectric sensors |
| Sensor/ detection principle | Photoelectric retro-reflective sensor, Dual lens |
| Dimensions (W x H x D) | 20 mm x 50 mm x 51.5 mm |
| Housing design (light emission) | Rectangular |
| Sensing range max. | 0.08 m ... 15 m ¹⁾ 0.08 m ... 12 m ²⁾ |
| Sensing range | 0.15 m ... 12 m ¹⁾ 0.15 m ... 10 m ²⁾ |
| Type of light | Visible red light |
| Light source | PinPoint LED ³⁾ |
| Light spot size (distance) | Ø 58 mm (5 m) |
| Wave length | 625 nm |
| Adjustment | Potentiometer, 270° |

¹⁾ Reflector PL80A.

²⁾ Reflector P250.

³⁾ Average service life: 100,000 h at T_J = +25 °C.

Mechanics/electronics

| | |
|--|--|
| Supply voltage | 24 V AC/DC ... 240 V AC/DC ¹⁾ |
| Ripple | < 5 V _{pp} ²⁾ |
| Power consumption | ≤ 2.5 VA |
| Switching output | Relay, SPDT, electrically isolated ³⁾ |
| Switching load max. (current/voltage) | 0.11 A (250 V DC) 3 A (30 V DC) 3 A (250 V AC) |
| Response time | ≤ 10 ms |
| Switching frequency | 20 Hz ⁴⁾ |
| Connection type | Cable, 5-wire, 2 m ⁵⁾ |
| Cable material | PVC |
| Conductor cross-section | 0.25 mm ² |
| Circuit protection | C ⁶⁾ |
| Protection class | II ⁷⁾ |
| Weight | 115 g |
| Polarisation filter | ✓ |
| Interference emission | EN 61000-6-3 (2011-09) ⁸⁾ |
| Housing material | Plastic, ABS/PMMA |
| Enclosure rating | IP67 |
| Relay switching cycles min. | 100.000 cycles (3 A) |
| Items supplied | Mounting bracket BEF-G10UC01, Reflector P250 |
| Usage category | AC-15, DC-13, according to EN 60947-1 |
| Electromagnetic compatibility (EMC) | EN 60947-5-2 EN 61000-6-3 (2011-09) |
| Ambient operating temperature | -30 °C ... +60 °C ⁹⁾ |
| Ambient temperature, storage | -40 °C ... +70 °C |
| UL File No. | NRKH.E348498 & NRKH7.E348498 |
| More standards | UL325 ¹⁰⁾ |

¹⁾ +- 10 %.

²⁾ May not exceed or fall below U_v tolerances.

³⁾ Provide suitable spark suppression for inductive or capacitive loads.

⁴⁾ With light/dark ratio 1:1.

⁵⁾ Do not bend below 0 °C.

⁶⁾ C = interference suppression.

⁷⁾ Reference voltage: 250 V AC.

⁸⁾ In the case of a DC supply (ref. to EN 61000-6-3) the length of cable between the supply source and the sensor must be < 30 m.

⁹⁾ UL: 0 °C ... +50 °C.

¹⁰⁾ Complies with the UL325 standard when used with sturdy protection hood (e.g. BEF-G10WSG, 2071960).

Classifications

| | |
|---------------------|----------|
| ECl@ss 5.0 | 27270902 |
| ECl@ss 5.1.4 | 27270902 |
| ECl@ss 6.0 | 27270902 |
| ECl@ss 6.2 | 27270902 |

| | |
|-----------------------|----------|
| ECl@ss 7.0 | 27270902 |
| ECl@ss 8.0 | 27270902 |
| ECl@ss 8.1 | 27270902 |
| ECl@ss 9.0 | 27270902 |
| ECl@ss 10.0 | 27270902 |
| ECl@ss 11.0 | 27270902 |
| ETIM 5.0 | EC002717 |
| ETIM 6.0 | EC002717 |
| ETIM 7.0 | EC002717 |
| ETIM 8.0 | EC002717 |
| UNSPSC 16.0901 | 39121528 |

Connection diagram

Cd-163

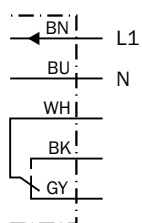

Characteristic curve

GL10

Operating reserve

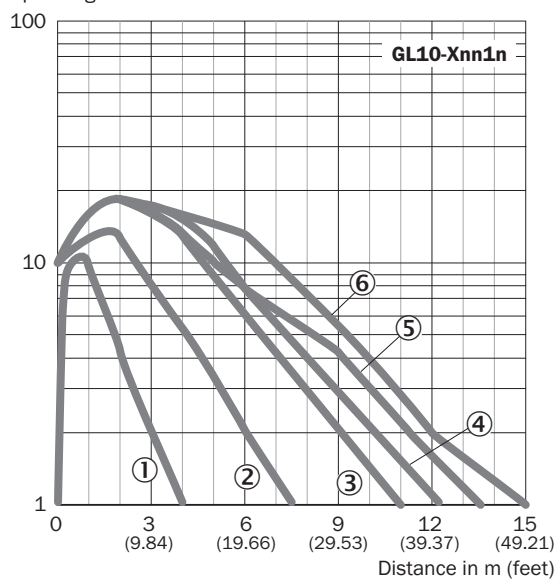

Light spot size

Light spot size

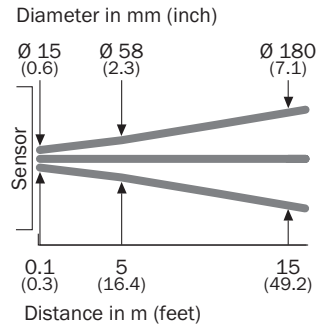

Sensing range diagram

GL10

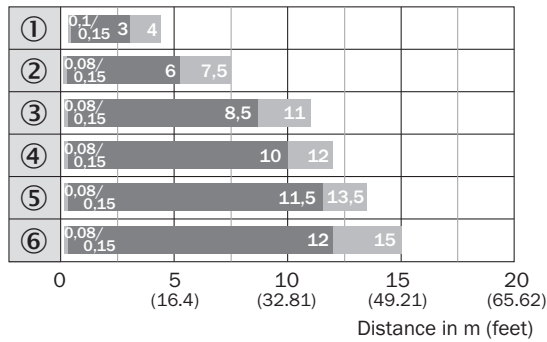

■ Sensing range ■ Sensing range max.

- ① Reflective tape REF-IRF-56
- ② Reflector PL20A
- ③ Reflector PL30A
- ④ Reflector P250
- ⑤ Reflector PL40A
- ⑥ Reflector PL80A

Adjustments

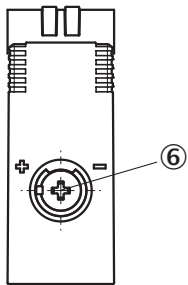

⑥ Adjustment of sensing range

Dimensional drawing (Dimensions in mm (inch))



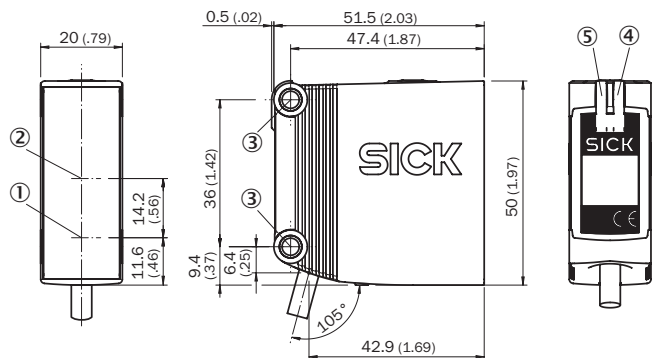

GTE10, GL10, GL10G, AC/DC, cable



- ① Center of optical axis, sender
- ② Center of optical axis, receiver
- ③ Mounting hole, \varnothing 4.2 mm
- ④ LED indicator yellow: Status of received light beam
- ⑤ LED indicator green: power on

Recommended accessories

Other models and accessories → www.sick.com/G10

| | Brief description | Type | Part no. |
|---|---|---------------|----------|
| Universal bar clamp systems | | | |
|  | Q-Lock, bar clamp system for G10 and reflector P250, Die-cast zinc, steel, zinc coated | BEF-KHSQ12R01 | 2071260 |
| Mounting brackets and plates | | | |
|  | Universal mounting bracket for reflectors, steel, zinc coated | BEF-WN-REFX | 2064574 |
| Plug connectors and cables | | | |
|  | Head A: male connector, M12, 5-pin, straight Cable: unshielded For field bus technology | STE-1205-G | 6022083 |
| Reflectors | | | |
|  | Rectangular, screw connection, 51 mm x 61 mm, PMMA/ABS, Screw-on, 2 hole mounting | P250 | 5304812 |

SICK AT A GLANCE

SICK is one of the leading manufacturers of intelligent sensors and sensor solutions for industrial applications. A unique range of products and services creates the perfect basis for controlling processes securely and efficiently, protecting individuals from accidents and preventing damage to the environment.

We have extensive experience in a wide range of industries and understand their processes and requirements. With intelligent sensors, we can deliver exactly what our customers need. In application centers in Europe, Asia and North America, system solutions are tested and optimized in accordance with customer specifications. All this makes us a reliable supplier and development partner.

Comprehensive services complete our offering: SICK LifeTime Services provide support throughout the machine life cycle and ensure safety and productivity.

For us, that is “Sensor Intelligence.”

WORLDWIDE PRESENCE:

Contacts and other locations –www.sick.com