

Programmable Panel-Mount Digital Multi-Timer

Altech's AMT33 Series of Programmable Panel-Mount Digital Multi-Timers comprises 2 models featuring 33 Timing Functions and 2 separate Outputs with selectable Timing modes for maximum flexibility in automation and control applications. Timing Range is adjustable from 0.1s to 999 days. A Digital 7-Segment shows current Run Time information and Input/Output states.



Features

- 33 Built-in Timing Functions
- Supply Voltage 110-240 VAC
- 7 Segment Digital LED Display
- 2 Separate Output Channels
- Individually selectable Timing Functions
- Wide Timing Range 0.1s - 999 days
- Compact Design
- Panel & DIN rail (11-pin socket) mount

CAT. NO.	AMT33-S2	AMT33-S2-11
Mounting	Panel Mount	DIN / 11-pin Socket Mount

Specifications

Electrical

Supply Voltage	110-240VAC (-20% to +10%), 50/ 60Hz
Power Consumption	9 VA max.
Timing Range	0.1s - 999 days
Reset Time/ Initiation Time	max. 200ms/ 100ms
Timing Accuracy	+/- 0.01%

Input

Input Signal	High Range: 85-265VAC/ 100-265DC Low Range: 24-60V AC/DC
Signal Sensing Time	50ms max. (10ms for DC)
Signal Wait Period	100ms @ Power on/ signal based modes
Signal Isolation	2kV

Output

Output Configuration	2 x SPDT (C/O)
Output Contact Rating	5A (NO), 3A (NC)
Electrical Life	10,000 switching cycles
Mechanical Life	500,000 switching cycles
AC-15 Rating	250VAC/ 2A, cosΦ=0.6, 85°C
DC-13 Rating	Rated Voltage (Ue): 24VDC, Rated Current (Ie): 2.0A

Material

Operating Temperature	-5°C - 55°C (23°F - 131°F)
Storage Temperature	-10°C - 60°C (14°F - 140°F)
Protection Enclosure	IP30 (Enclosure), IP20 (Terminals)
Torque Terminals	0.50 Nm (3.5lb.in.), M3 screw
Terminal Wire Size	0.12-2.0mm2 (26-14AWG)
Weight	160g (0.35lb)

TIMING FUNCTIONS

MODE 00	ON Delay
MODE 01	ON Delay constant supply 2
MODE 02	ON Delay constant supply 3
MODE 03	ON Delay (Control Switch resettable)
MODE 04	Signal ON Delay
MODE 05	Inverted Signal ON Delay
MODE 06	Inverted Signal ON Delay 2
MODE 07	Signal OFF Delay
MODE 08	OFF Delay constant supply 2
MODE 09	Cyclic ON/ OFF
MODE 10	Cyclic OFF/ ON
MODE 11	Asymmetric Cycle Pulse Start
MODE 12	Asymmetric Recycle Pulse Start 2
MODE 13	Signal ON/ OFF Delay
MODE 14	Signal ON/ OFF Delay 2
MODE 15	Signal OFF/ ON
MODE 16	Impulse on Energizing
MODE 17	Impulse ON/ OFF
MODE 18	Accumulative Delay ON Signal
MODE 19	Accumulative Delay ON Inverted Signal
MODE 20	Accumulative Impulse ON Signal
MODE 21	Leading Edge Impulse 1
MODE 22	Leading Edge Impulse 2
MODE 23	Trailing Edge Impulse 1
MODE 24	Trailing Edge Impulse 2
MODE 25	Delayed Impulse 1
MODE 26	Delayed Impulse 2
MODE 27	Delayed Pulse constant supply, power based
MODE 28	Delayed Pulse (Remote Trigger)
MODE 29	Delayed Pulse constant supply 2
MODE 30	ON Pulse (Control Switch resettable)/ Watchdog Type
MODE 31	On Pulse (Supply Reset)
MODE 32	Leading Edge Bi-stable or Step Relay

Connection Diagrams

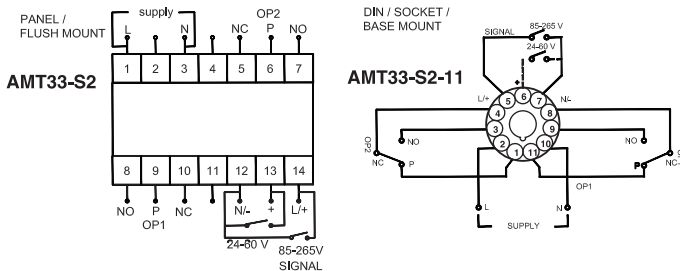

Dimensions

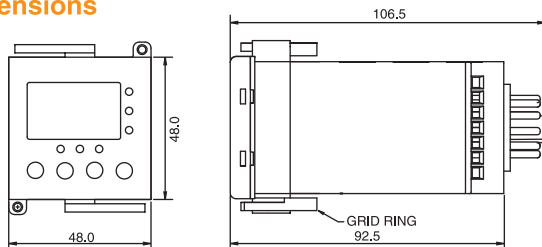

DISPLAY FUNCTIONS

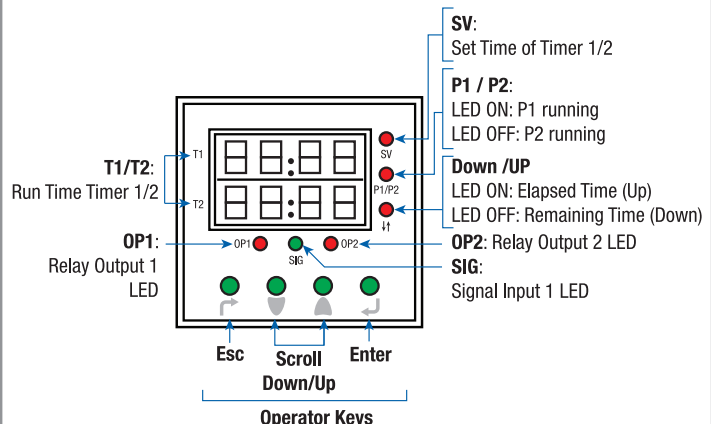

ON DELAY [00]

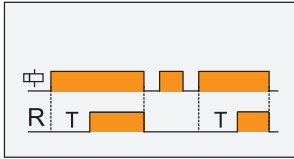

ON DELAY CONSTANT SUPPLY TYPE 2 [01]

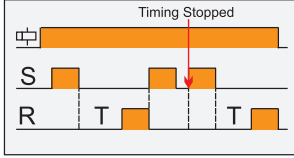

ON DELAY CONSTANT SUPPLY TYPE 3 [02]

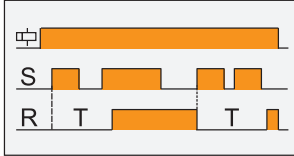

ON DELAY (CONTROL SWITCH RESETTABLE) [03]

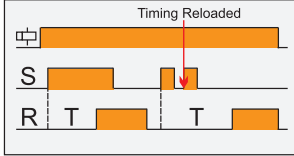

SIGNAL ON DELAY [04]

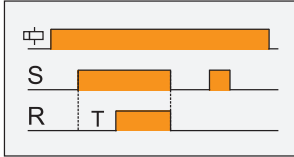

INVERTED SIGNAL ON DELAY [05]

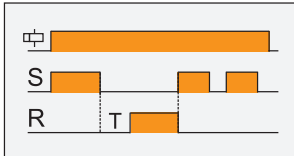

INVERTED SIGNAL ON DELAY-TYPE 2 [06]

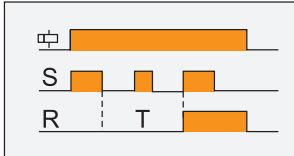

SIGNAL OFF DELAY [07]

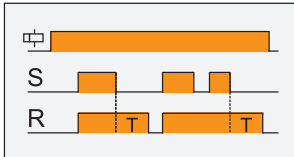

OFF DELAY CONST. SUPPLY TYPE 2 [08]

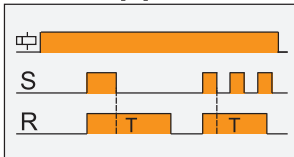

CYCLIC ON/OFF {ON start, (Sym, Asym)} [09]

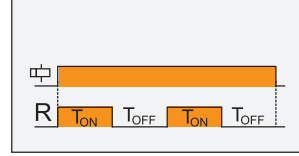

CYCLIC OFF/ON {OFF Start, (Sym, Asym)} [10]

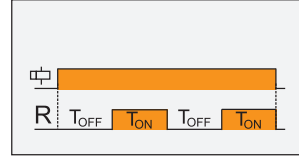

ASYMMETRIC CYCLE PULSE START [11]

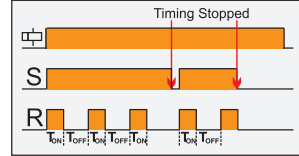

ASYMMETRIC RECYCLER PULSE START TYPE 2 [12]

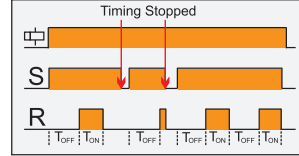

SIGNAL ON OFF DELAY [13]

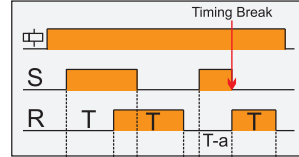

SIGNAL ON OFF DELAY TYPE 2 [14]

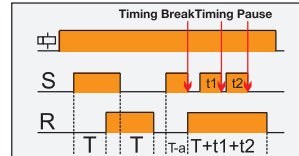

SIGNAL OFF/ON [15]

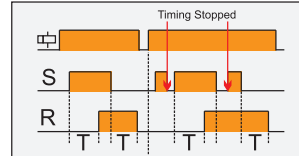

IMPULSE ON ENERGIZING [16]

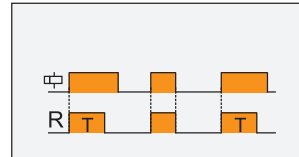

IMPULSE ON/OFF [17]

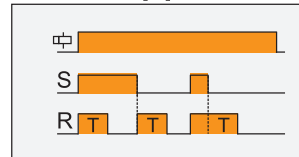

ACCUMULATIVE DELAY ON SIGNAL [18]

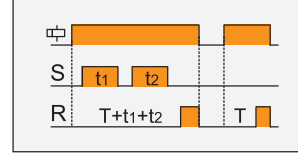

ACCUMULATIVE DELAY ON INVERTED SIGNAL [19]

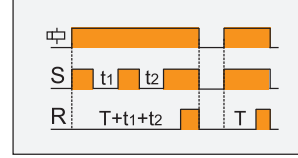

ACCUMULATIVE IMPULSE ON SIGNAL [20]

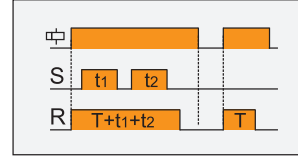

LEADING EDGE IMPULSE1 [21]

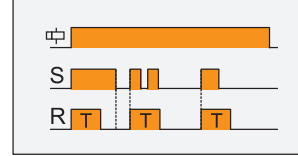

LEADING EDGE IMPULSE2 [22]

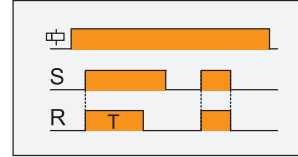

TRAILING EDGE IMPULSE1 [23]

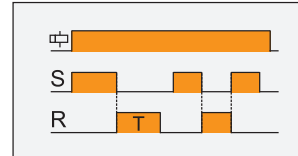

TRAILING EDGE IMPULSE2 [24]

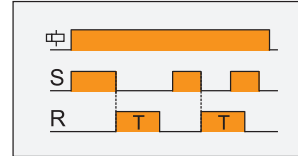

DELAYED IMPULSE [25]

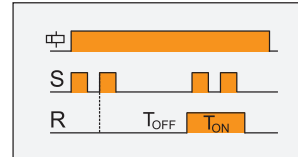

DELAYED IMPULSE TYPE 2 [26]

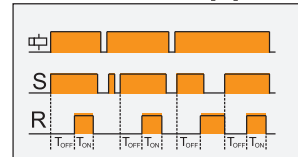

DELAYED PULSE (CONSTANT SUPPLY) POWER BASED [27]

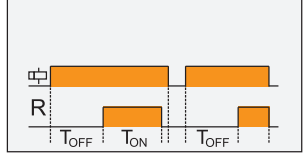

DELAYED PULSE (REMOTE TRIG.) [28]

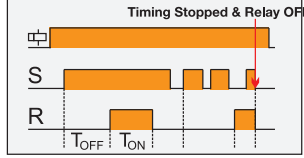

DELAYED PULSE (CONST. SUPPLY TYPE 1) [29]

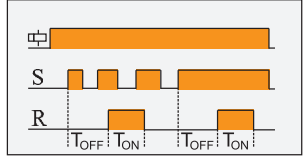

ON PULSE (CONTROL SWITCH RESETTABLE) / WATCH DOG TYPE [30]

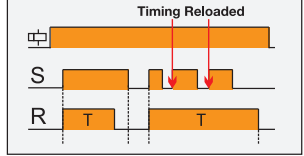

ON PULSE (SUPPLY RESET)[31]

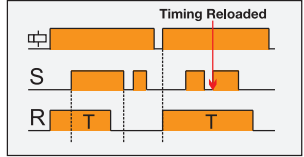

LEADING EDGE BI-STABLE OR STEP RELAY [32]

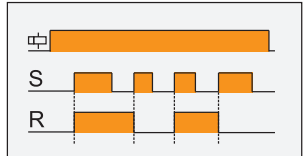

- ⊞ Supply Voltage
- S Signal B1
- R Relay Output
- T Set Time
- T_{ON} Set ON Time
- T_{OFF} Set OFF Time