

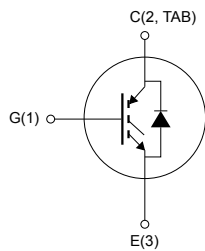

Automotive-grade trench gate field-stop, 650 V, 120 A, low-loss, M series IGBT in a Max247 long leads package

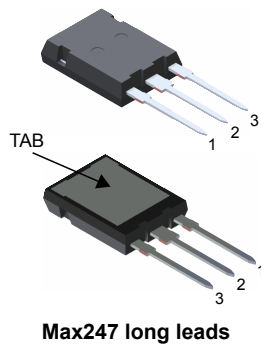

NG1E3C2T



Features

- AEC-Q101 qualified 
- 6 μ s of short-circuit withstand time
- $V_{CE(sat)} = 1.65$ V (typ.) @ $I_C = 120$ A
- Tight parameter distribution
- Safer paralleling
- Positive $V_{CE(sat)}$ temperature coefficient
- Low thermal resistance
- Soft and very fast recovery antiparallel diode
- Maximum junction temperature: $T_J = 175$ °C

Applications

- Heating system
- HV battery disconnect and fire-off system
- Main inverter (electric traction)

Description

This device is an IGBT developed using an advanced proprietary trench gate field-stop structure. The device is part of the M series IGBTs, which represent an optimal balance between inverter system performance and efficiency where the low-loss and the short-circuit functionality is essential. Furthermore, the positive $V_{CE(sat)}$ temperature coefficient and the tight parameter distribution result in safer paralleling operation.

Product status link

[STGYA120M65DF2AG](#)

Product summary

Order code	STGYA120M65DF2AG
Marking	G120M65DF2AG
Package	Max247 long leads
Packing	Tube

1 Electrical ratings

Table 1. Absolute maximum ratings

Symbol	Parameter	Value	Unit
V_{CES}	Collector-emitter voltage ($V_{GE} = 0$ V)	650	V
$I_C^{(1)}$	Continuous collector current at $T_C = 25$ °C	160	A
I_C	Continuous collector current at $T_C = 100$ °C	120	
$I_{CP}^{(2)}$	Pulsed collector current	360	A
V_{GE}	Gate-emitter voltage	±20	V
$I_F^{(1)}$	Continuous forward current at $T_C = 25$ °C	160	A
I_F	Continuous forward current at $T_C = 100$ °C	120	
$I_{FP}^{(2)}$	Pulsed forward current	360	A
P_{TOT}	Total power dissipation at $T_C = 25$ °C	625	W
T_{STG}	Storage temperature range	-55 to 150	°C
T_J	Operating junction temperature range	-55 to 175	

1. Current level is limited by bond wires.
2. Pulse width limited by maximum junction temperature.

Table 2. Thermal data

Symbol	Parameter	Value	Unit
R_{thJC}	Thermal resistance, junction-case IGBT	0.24	°C/W
R_{thJC}	Thermal resistance, junction-case diode	0.6	
R_{thJA}	Thermal resistance, junction-ambient	50	

2 Electrical characteristics

$T_C = 25\text{ °C}$ unless otherwise specified

Table 3. Static characteristics

Symbol	Parameter	Test conditions	Min.	Typ.	Max.	Unit
$V_{(BR)CES}$	Collector-emitter breakdown voltage	$V_{GE} = 0\text{ V}, I_C = 250\text{ }\mu\text{A}$	650			V
$V_{CE(sat)}$	Collector-emitter saturation voltage	$V_{GE} = 15\text{ V}, I_C = 120\text{ A}$		1.65	2.15	V
		$V_{GE} = 15\text{ V}, I_C = 120\text{ A}, T_J = 125\text{ °C}$		1.95		
		$V_{GE} = 15\text{ V}, I_C = 120\text{ A}, T_J = 175\text{ °C}$		2.1		
V_F	Forward on-voltage	$I_F = 120\text{ A}$		1.9	2.6	V
		$I_F = 120\text{ A}, T_J = 125\text{ °C}$		1.7		
		$I_F = 120\text{ A}, T_J = 175\text{ °C}$		1.6		
$V_{GE(th)}$	Gate threshold voltage	$V_{CE} = V_{GE}, I_C = 2\text{ mA}$	5	6	7	V
I_{CES}	Collector cut-off current	$V_{GE} = 0\text{ V}, V_{CE} = 650\text{ V}$			100	μA
I_{GES}	Gate-emitter leakage current	$V_{CE} = 0\text{ V}, V_{GE} = \pm 20\text{ V}$			± 250	μA

Table 4. Dynamic characteristics

Symbol	Parameter	Test conditions	Min.	Typ.	Max.	Unit
C_{ies}	Input capacitance	$V_{CE} = 25\text{ V}, f = 1\text{ MHz}, V_{GE} = 0\text{ V}$	-	11000	-	pF
C_{oes}	Output capacitance		-	610	-	
C_{res}	Reverse transfer capacitance		-	250	-	
Q_g	Total gate charge	$V_{CC} = 520\text{ V}, I_C = 120\text{ A},$	-	420	-	nC
Q_{ge}	Gate-emitter charge	$V_{GE} = 0\text{ to }15\text{ V}$	-	90	-	
Q_{gc}	Gate-collector charge	(see Figure 30. Gate charge test circuit)	-	160	-	

Table 5. IGBT switching characteristics (inductive load)

Symbol	Parameter	Test conditions	Min.	Typ.	Max.	Unit	
$t_{d(on)}$	Turn-on delay time	$V_{CE} = 400\text{ V}$, $I_C = 120\text{ A}$, $V_{GE} = 15\text{ V}$, $R_G = 4.7\ \Omega$ (see Figure 29. Test circuit for inductive load switching)		66	-	ns	
t_r	Current rise time			38	-	ns	
$(di/dt)_{on}$	Turn-on current slope				2500	-	A/ μ s
$t_{d(off)}$	Turn-off-delay time				185	-	ns
t_f	Current fall time				85	-	ns
$E_{on}^{(1)}$	Turn-on switching energy				1.8	-	mJ
$E_{off}^{(2)}$	Turn-off switching energy				4.41	-	mJ
E_{ts}	Total switching energy				6.21	-	mJ
$t_{d(on)}$	Turn-on delay time		$V_{CE} = 400\text{ V}$, $I_C = 120\text{ A}$, $V_{GE} = 15\text{ V}$, $R_G = 4.7\ \Omega$, $T_J = 175\text{ }^\circ\text{C}$ (see Figure 29. Test circuit for inductive load switching)		62	-	ns
t_r	Current rise time				48	-	ns
$(di/dt)_{on}$	Turn-on current slope				2016	-	A/ μ s
$t_{d(off)}$	Turn-off-delay time				187	-	ns
t_f	Current fall time				164	-	ns
$E_{on}^{(1)}$	Turn-on switching energy				4.4	-	mJ
$E_{off}^{(2)}$	Turn-off switching energy				6.0	-	mJ
E_{ts}	Total switching energy				10.4	-	mJ
t_{sc}	Short-circuit withstand time	$V_{CC} \leq 400\text{ V}$, $V_{GE} = 13\text{ V}$, $T_{Jstart} = 150\text{ }^\circ\text{C}$		10		-	μ s
		$V_{CC} \leq 400\text{ V}$, $V_{GE} = 15\text{ V}$, $T_{Jstart} = 150\text{ }^\circ\text{C}$	6		-		

1. Including the reverse recovery of the diode.
2. Including the tail of the collector current.

Table 6. Diode switching characteristics (inductive load)

Symbol	Parameter	Test conditions	Min.	Typ.	Max.	Unit	
t_{rr}	Reverse recovery time	$I_F = 120\text{ A}$, $V_R = 400\text{ V}$, $V_{GE} = 15\text{ V}$, $di/dt = 1000\text{ A}/\mu\text{s}$ (see Figure 29. Test circuit for inductive load switching)	-	202	-	ns	
Q_{rr}	Reverse recovery charge			-	2.9	-	μ C
I_{rrm}	Reverse recovery current			-	32.5	-	A
dI_{rr}/dt	Peak rate of fall of reverse recovery current during t_b			-	500	-	A/ μ s
E_{rr}	Reverse recovery energy			-	500	-	μ J
t_{rr}	Reverse recovery time	$I_F = 120\text{ A}$, $V_R = 400\text{ V}$, $V_{GE} = 15\text{ V}$, $di/dt = 1000\text{ A}/\mu\text{s}$, $T_J = 175\text{ }^\circ\text{C}$ (see Figure 29. Test circuit for inductive load switching)	-	320	-	ns	
Q_{rr}	Reverse recovery charge			-	11.2	-	μ C
I_{rrm}	Reverse recovery current			-	62	-	A
dI_{rr}/dt	Peak rate of fall of reverse recovery current during t_b			-	270	-	A/ μ s
E_{rr}	Reverse recovery energy			-	1710	-	μ J

2.1 Electrical characteristics (curves)

Figure 1. Power dissipation vs case temperature

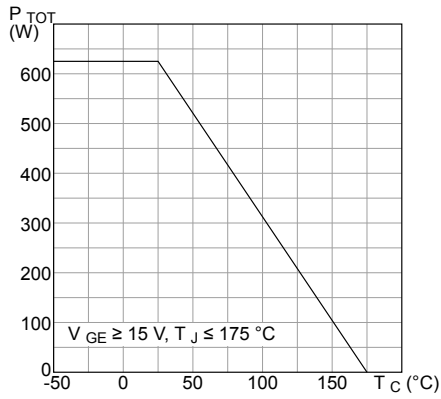

Figure 2. Collector current vs case temperature

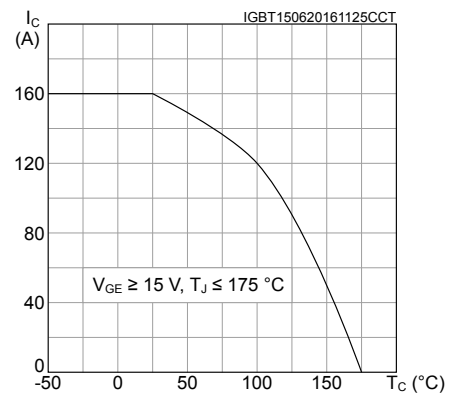

Figure 3. Output characteristics (T_J = 25 °C)

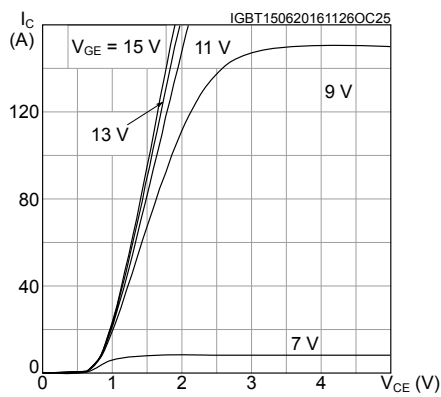

Figure 4. Output characteristics (T_J = 175 °C)

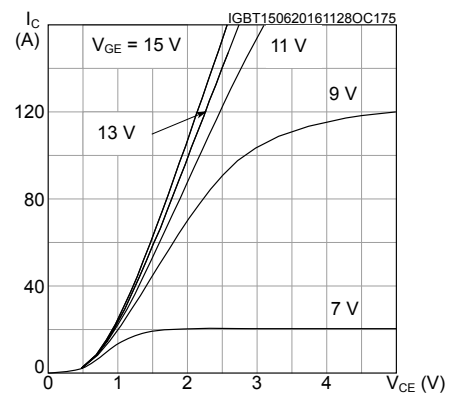

Figure 5. V_{CE(sat)} vs junction temperature

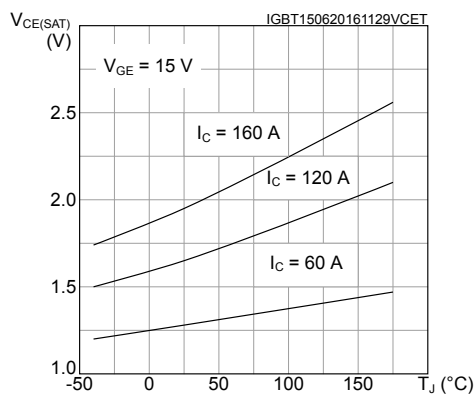

Figure 6. V_{CE(sat)} vs collector current

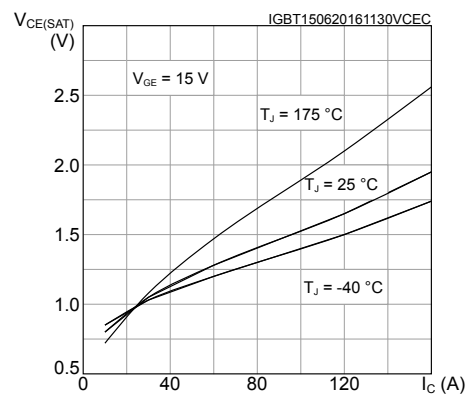

Figure 7. Collector current vs switching frequency

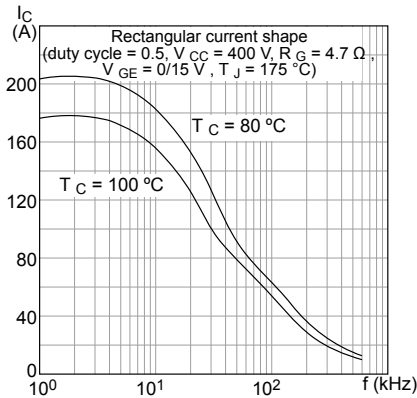

Figure 8. Forward bias safe operating area

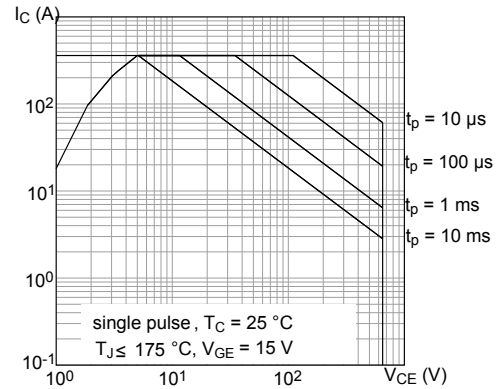

Figure 9. Transfer characteristics

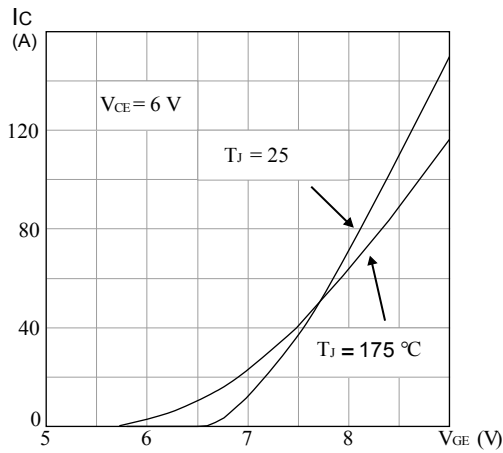

Figure 10. Diode V_F vs forward current

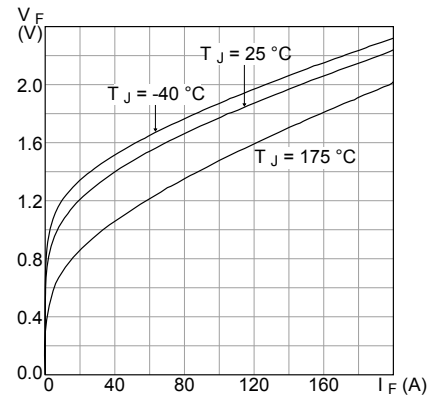

Figure 11. Normalized V_{GE(th)} vs junction temperature

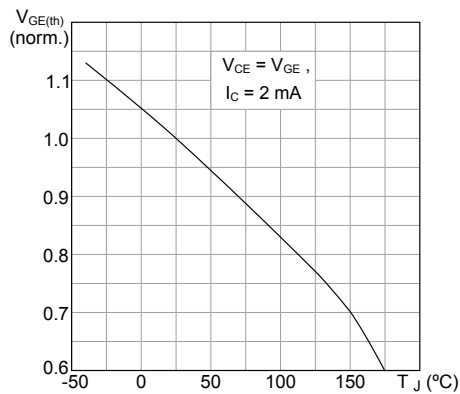

Figure 12. Normalized V_{(BR)CES} vs junction temperature

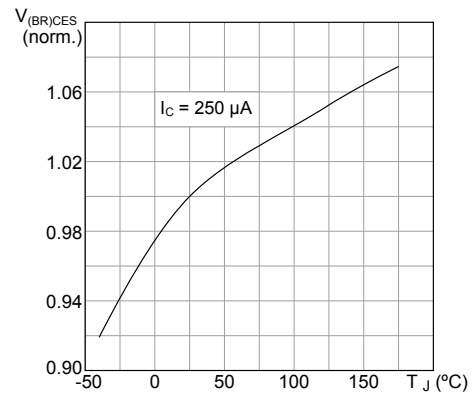

Figure 13. Capacitance variations

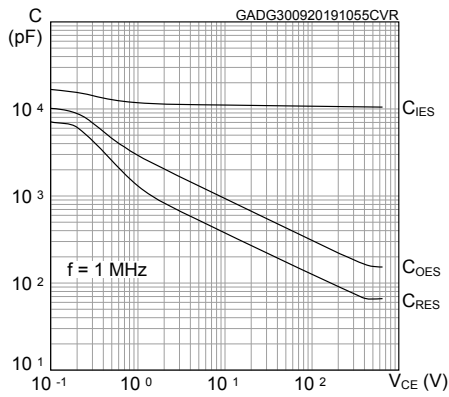

Figure 14. Gate charge vs gate-emitter voltage

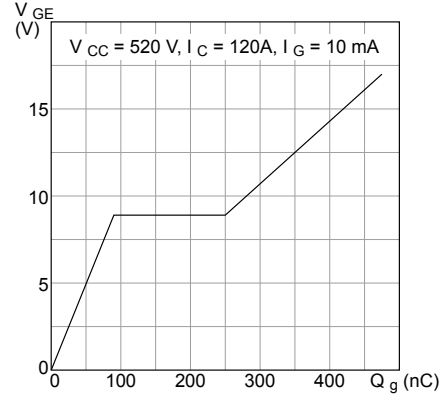

Figure 15. Switching energy vs collector current

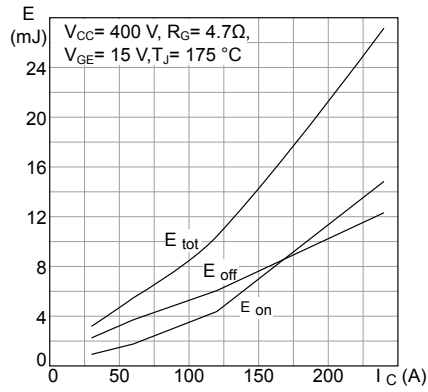

Figure 16. Switching energy vs gate resistance

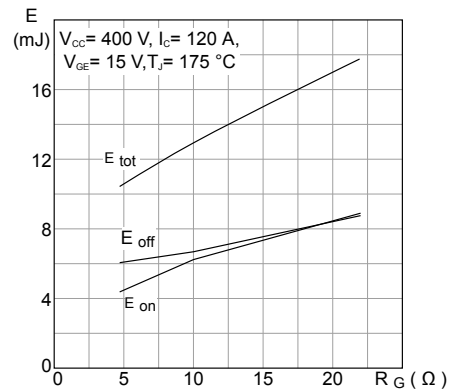

Figure 17. Switching energy vs temperature

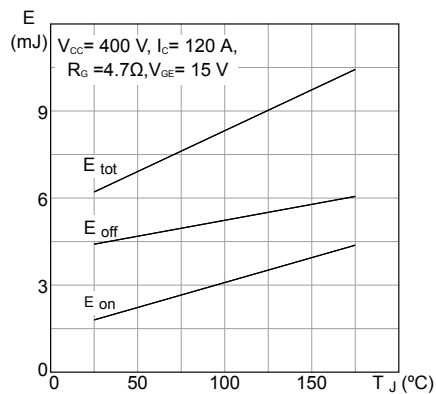

Figure 18. Switching energy vs collector emitter voltage

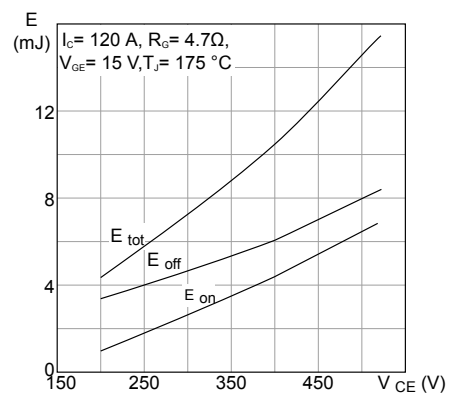

Figure 19. Short circuit time and current vs V_{GE}

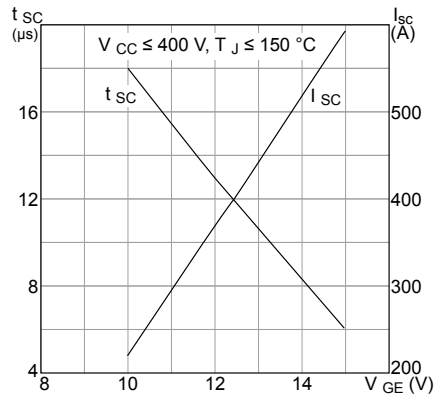

Figure 20. Switching times vs collector current

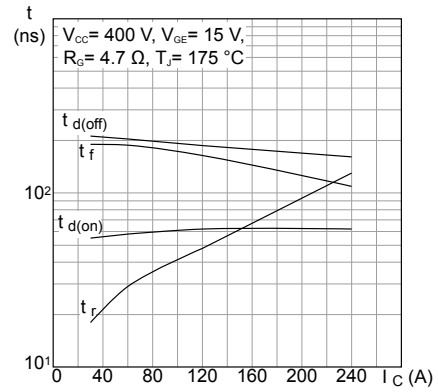

Figure 21. Switching times vs gate resistance

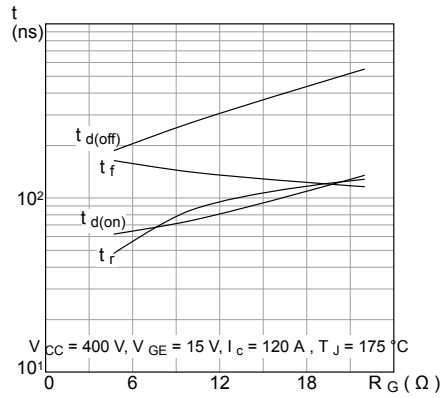

Figure 22. Reverse recovery current vs diode current slope

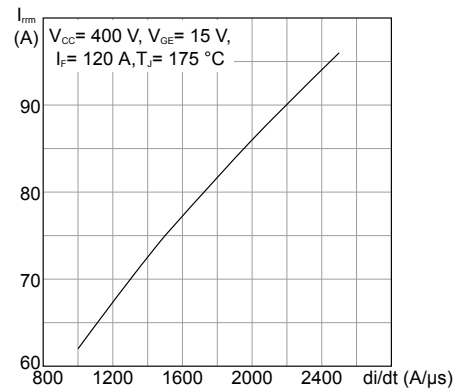

Figure 23. Reverse recovery time vs diode current slope

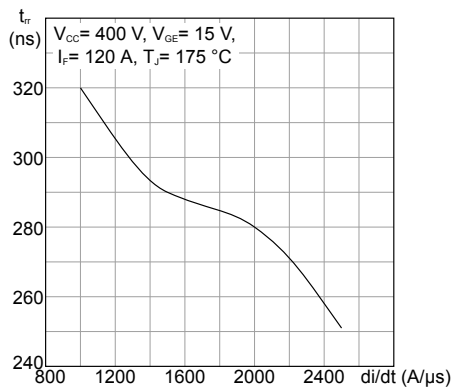

Figure 24. Reverse recovery charge vs diode current slope

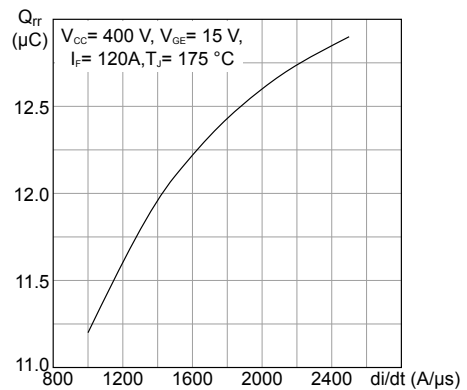

Figure 25. Reverse recovery energy vs diode current slope

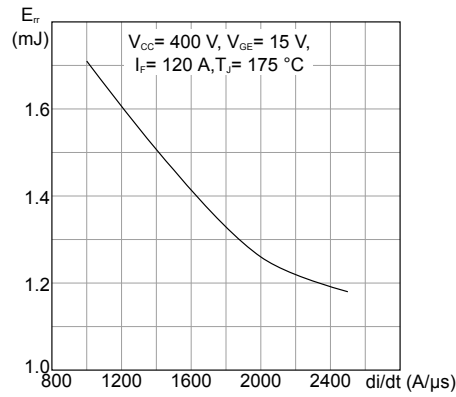

Figure 26. Thermal impedance for IGBT

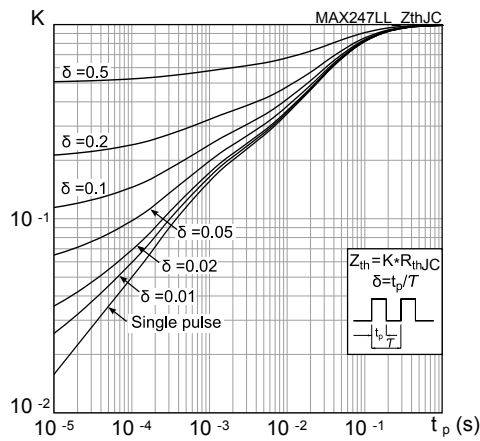
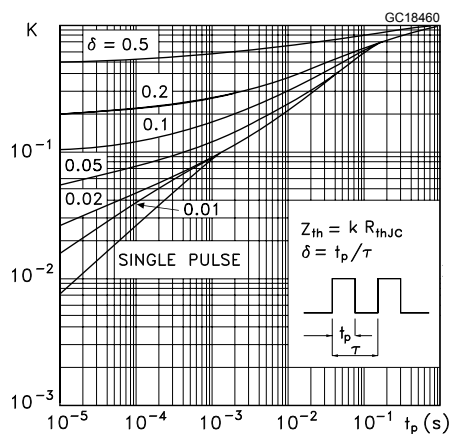

Figure 27. Thermal impedance for diode



4 Package information

In order to meet environmental requirements, ST offers these devices in different grades of **ECOPACK** packages, depending on their level of environmental compliance. ECOPACK specifications, grade definitions and product status are available at: www.st.com. ECOPACK is an ST trademark.

4.1 Max247 long leads package information

Figure 32. Max247 long leads package outline

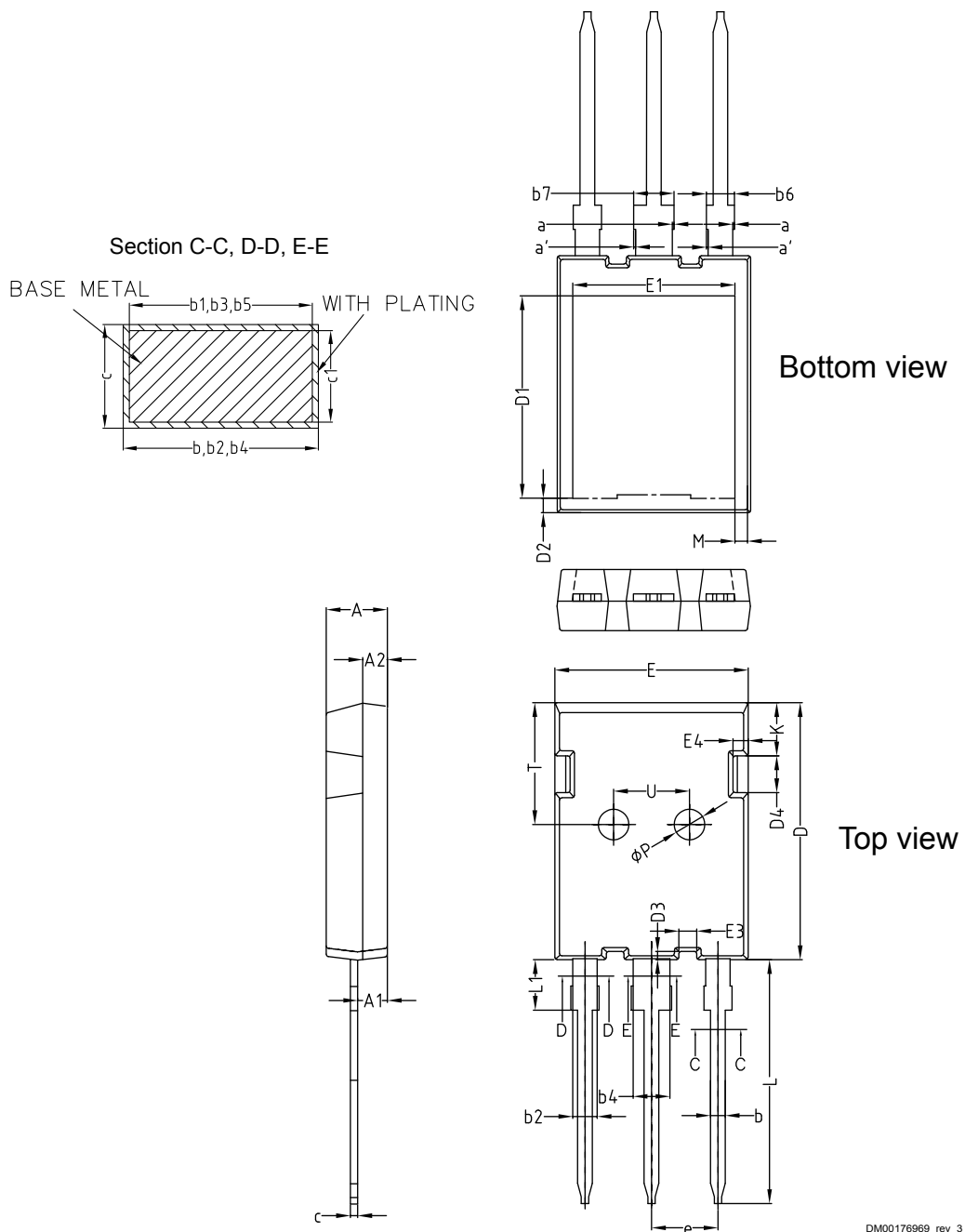

DM00176969_rev_3

Table 7. Max247 long leads package mechanical data

Dim.	mm		
	Min.	Typ.	Max.
A	4.90	5.00	5.10
A1	2.31	2.41	2.51
A2	1.90	2.00	2.10
a	0		0.15
a'	0		0.15
b	1.16		1.26
b1	1.15	1.20	1.22
b2	1.96		2.06
b3	1.95	2.00	2.02
b4	2.96		3.06
b5	2.95	3.00	3.02
b6			2.25
b7			3.25
c	0.59		0.66
c1	0.58	0.60	0.62
D	20.90	21.00	21.10
D1	16.25	16.55	16.85
D2	1.05	1.17	1.35
D3	0.58	0.68	0.78
D4	2.90	3.00	3.10
E	15.70	15.80	15.90
E1	13.10	13.26	13.50
E3	1.35	1.45	1.55
E4	1.14	1.24	1.34
e	5.34	5.44	5.54
K	4.25	4.35	4.45
L	19.80	19.92	20.10
L1	3.90		4.30
M	0.70		1.30
P	2.40	2.50	2.60
T	9.80		10.20
U	6.00		6.40

Revision history

Table 8. Document revision history

Date	Revision	Changes
12-Aug-2016	1	First release.
12-Dec-2016	2	Document status promoted from preliminary to production data. Minor text changes.
24-Aug-2017	3	Updated features and title in cover page. Updated <i>Table 4: "Static characteristics"</i> . Minor text changes.
08-Oct-2019	4	Updated <i>Table 4. Dynamic characteristics</i> . Updated <i>Figure 9. Forward bias safe operating area</i> and <i>Figure 14. Capacitance variations</i> . Minor text changes
16-Nov-2022	5	Updated Section 4.1 Max247 long leads package information . Minor text changes.

IMPORTANT NOTICE – READ CAREFULLY

STMicroelectronics NV and its subsidiaries (“ST”) reserve the right to make changes, corrections, enhancements, modifications, and improvements to ST products and/or to this document at any time without notice. Purchasers should obtain the latest relevant information on ST products before placing orders. ST products are sold pursuant to ST’s terms and conditions of sale in place at the time of order acknowledgment.

Purchasers are solely responsible for the choice, selection, and use of ST products and ST assumes no liability for application assistance or the design of purchasers’ products.

No license, express or implied, to any intellectual property right is granted by ST herein.

Resale of ST products with provisions different from the information set forth herein shall void any warranty granted by ST for such product.

ST and the ST logo are trademarks of ST. For additional information about ST trademarks, refer to www.st.com/trademarks. All other product or service names are the property of their respective owners.

Information in this document supersedes and replaces information previously supplied in any prior versions of this document.

© 2022 STMicroelectronics – All rights reserved