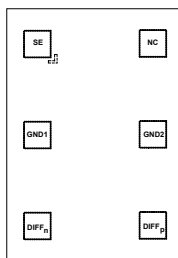
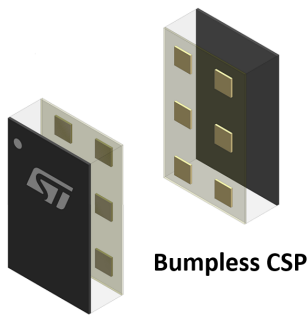


## 50 $\Omega$ to 100 $\Omega$ balun for UWB 3 GHz to 8 GHz



Top view (pads down)

**Product status link**

[BAL-UWB-01E3](#)

### Features

- Very low profile
- High RF performance
- PCB space saving
- Efficient manufacturability
- LGA footprint compatible
- Low thickness  $\leq 450 \mu\text{m}$
- High RF performance
- PCB space saving

### Applications

- High value asset tracking
- People tracking / gate
- Secure entry / transaction
- Vehicle keyless entry
- Healthcare

### Description

The BAL-UWB-01E3 is an ultra-miniature balun that integrates matching network, dedicated to ultra-wide band 3 GHz to 8 GHz.

This device uses STMicroelectronics IPD technology on non conductive glass substrate which optimizes RF performance.

# 1 Characteristics

**Table 1. Absolute maximum ratings**

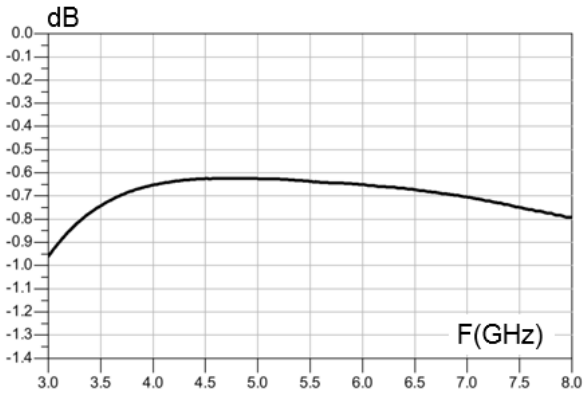
Symbol	Parameter	Value	Unit
$P_{IN}$	Input power $RF_{IN}$	10	dBm
$V_{ESD}$	ESD ratings human body model (JESD22-A114-C), all I/O one at a time while others connected to GND	2000	V
	ESD ratings machine model, all I/O	200	
$T_{OP}$	Maximum operating temperature	-40 to +105	°C

**Table 2. Electrical characteristics ( $T_{amb} = 25\text{ °C}$ )**

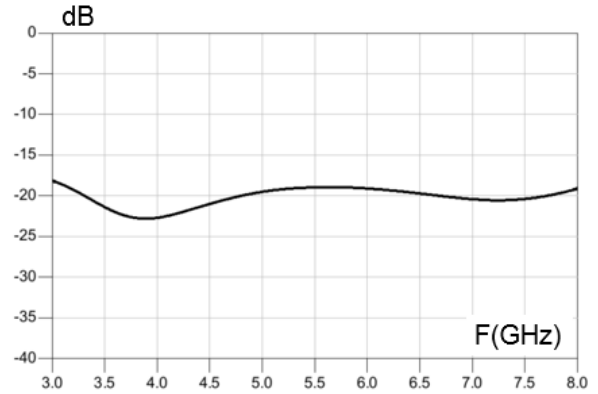
Symbol	Parameter	Value			Unit
		Min.	Typ.	Max.	
$Z_{DIFF}$	Nominal differential output impedance		100		$\Omega$
$Z_{SE}$	Nominal input impedance		50		$\Omega$
F	Frequency range (bandwidth)	3		8	GHz
IL	Insertion loss differential mode $ S_{ds21} $		1.0	1.2	dB
$RL_{SE}$	Input return loss single ended side $ S_{11} $	12	18		dB
$RL_{DIFF}$	Balanced return loss $ S_{dd22} $	13	16		dB
$\phi_{imb}$	Phase imbalance	-25		25	°
Aimb	Amplitude imbalance	-2.5		2.5	dB

### 1.1 RF simulation (Tamb = 25 °C)

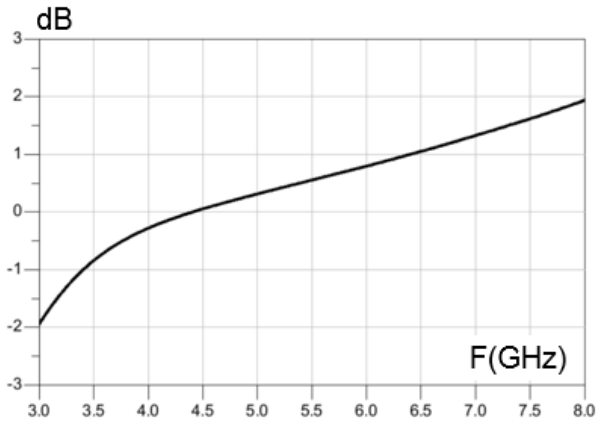
**Figure 1. Insertion loss (dB)**



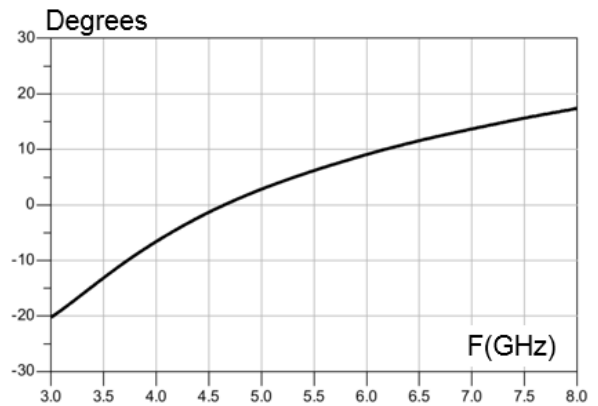
**Figure 2. SE return loss (dB)**



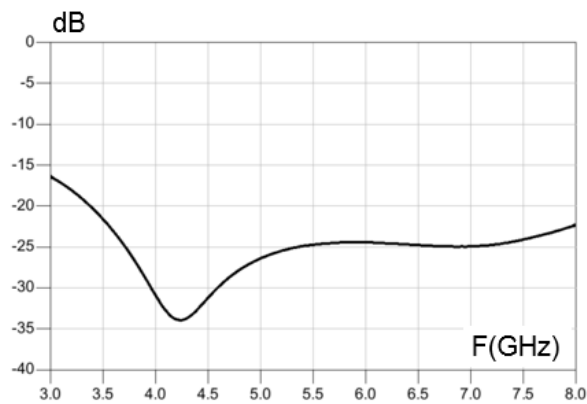
**Figure 3. Amplitude imbalance (dB)**



**Figure 4. Phase balance (°)**

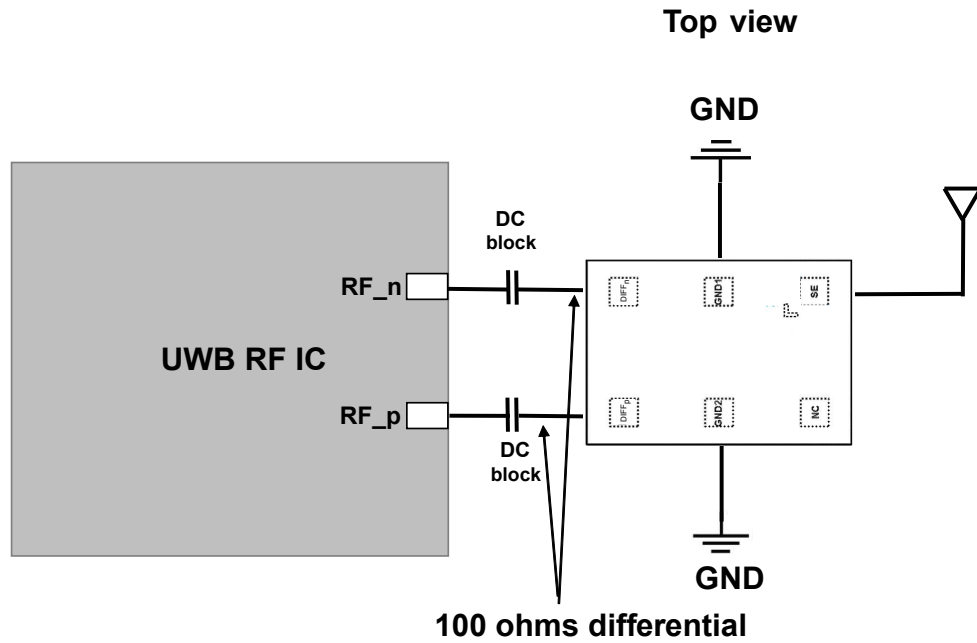


**Figure 5. Balanced return loss (dB)**



## 2 Application information

Figure 6. Application schematic

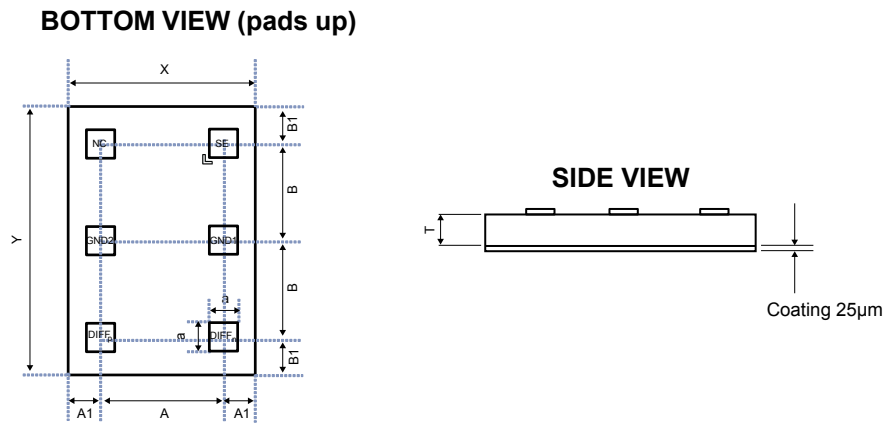


### 3 Package information

In order to meet environmental requirements, ST offers these devices in different grades of **ECOPACK** packages, depending on their level of environmental compliance. ECOPACK specifications, grade definitions and product status are available at: [www.st.com](http://www.st.com). ECOPACK is an ST trademark.

#### 3.1 Bumpless CSP package information

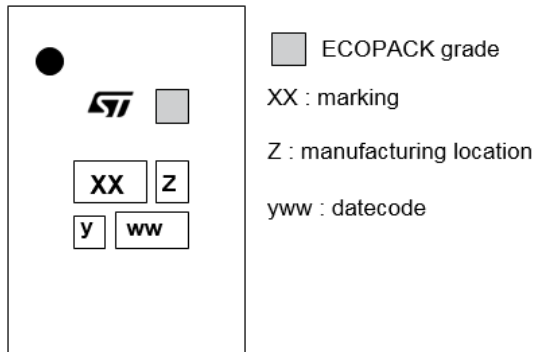
**Figure 7. Bumpless CSP package outline**



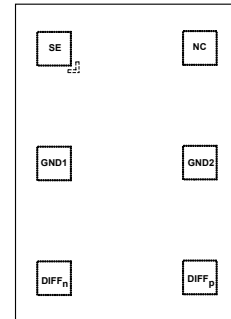
**Table 3. Bumpless CSP package mechanical data**

Parameter	Description	Min.	Typ.	Max.	Unit
X	X dimension of the die	1225	1250	1275	µm
Y	Y dimension of the die	1775	1800	1825	µm
A	X pitch		824		µm
B	Y pitch		650		µm
A1	Distance from bump to edge of die on X axis		213		µm
B1	Distance from pad to edge of die on Y axis		250		µm
a	Pad dimension		200		µm
T	Substrate thickness	375	400	425	µm

**Figure 8. Marking**



**Figure 9. Top view**

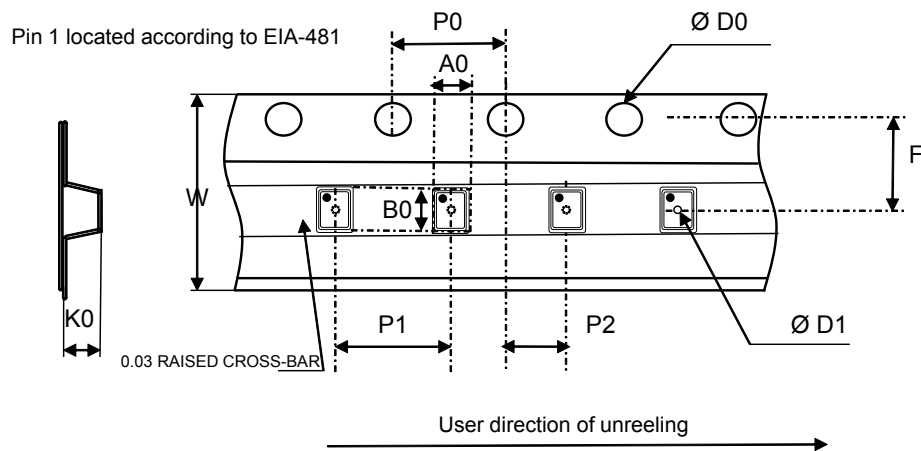


Top view (pads down)

More packing information is available in the application note:

- AN2348 Flip-Chip: "Package description and recommendations for use"

**Figure 10. Tape and reel outline**



Note: Pocket dimensions are not on scale  
Pocket shape may vary depending on package

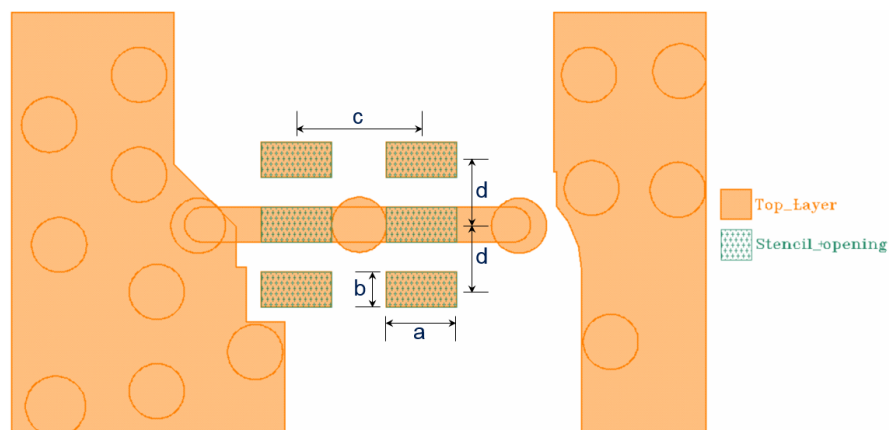
**Table 4. Tape and reel mechanical data**

Ref	Dimensions		
	Millimeters		
	Min	Typ	Max
A0	1.29	1.34	1.39
B0	1.84	1.89	1.94
K0	0.44	0.49	0.54
P1	3.9	4.0	4.1
P0	3.9	4.0	4.1
Ø D0	1.4	1.5	1.6
Ø D1	0.35	0.40	0.45
F	3.45	3.50	3.55
P2	1.95	2.00	2.05
W	7.9	8.0	8.3

**Table 5. Pin description**

Pad ref	Pad name	Description
A1	SE	Single Ended antenna
A2	GND1	Ground
B2	GND2	Ground
B1	NC	Non connected
A3	DIFF <sub>n</sub>	Balun differential negative
B3	DIFF <sub>p</sub>	Balun differential positive

**Figure 11. Stencil opening recommendation**



**Table 6. Stencil opening dimensions**

Parameter	Dimension	Unit
a	700	µm

Parameter	Dimension	Unit
b	350	μm
c	1250	
d	650	



## 4 Recommendation on PCB assembly

### 4.1 Land pattern recommendation

Figure 12. Land pattern recommendations

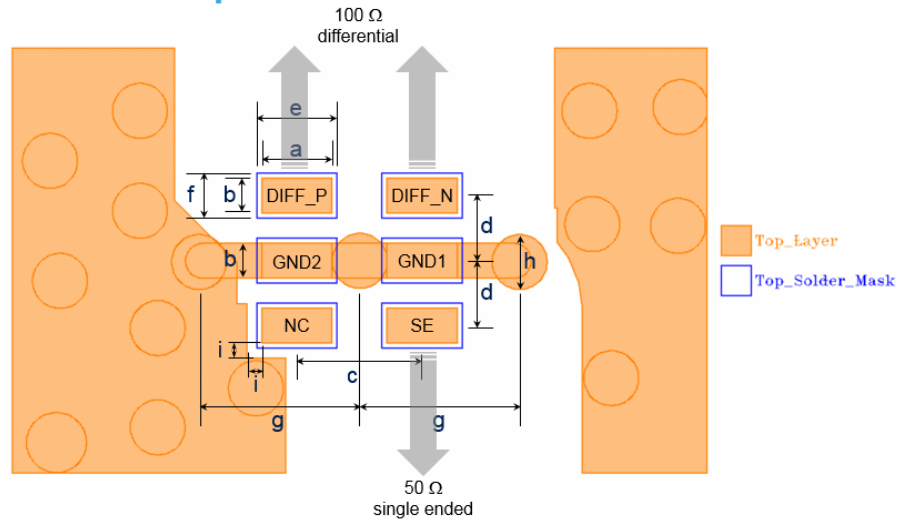
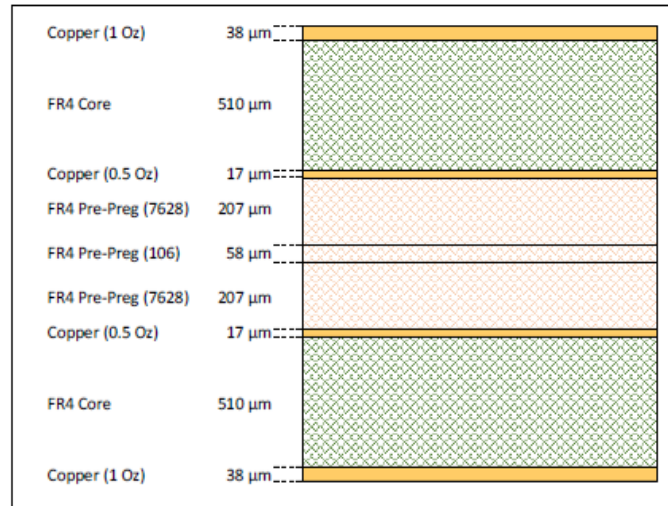


Table 7. Land pattern dimensions

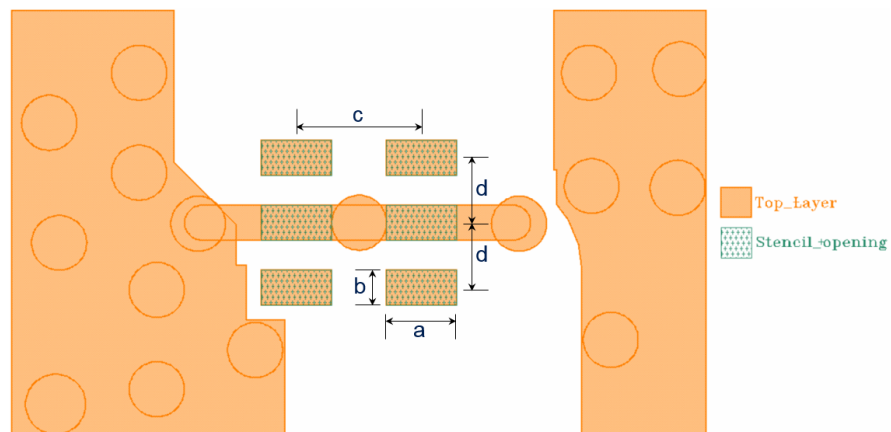
Parameter	Dimension	Unit
a	700	μm
b	350	
c	1250	
d	650	
e	800	
f	450	
g	1600	
h	550	
i	150	

Figure 13. PCB stack-up recommendations



## 4.2 Stencil opening design

Figure 14. Stencil opening recommendations



Note: Dimensions are displayed in Table 6. Stencil opening dimensions.

## 4.3 Solder paste

1. 100  $\mu\text{m}$  solder stencil thickness is recommended to be drunk
2. Halide-free flux qualification ROL0 according to ANSI/J-STD-004.
3. "No clean" solder paste is recommended.
4. Offers a high tack force to resist component movement during PCB movement.
5. Solder paste with fine particles: powder particle size is 20-45  $\mu\text{m}$ .

#### 4.4 Placement

1. Manual positioning is not recommended.
2. It is recommended to use the lead recognition capabilities of the placement system, not the outline centering
3. Standard tolerance of  $\pm 0.05$  mm is recommended.
4. 3.5 N placement force is recommended. Too much placement force can lead to squeezed out solder paste and cause solder joints to short. Too low placement force can lead to insufficient contact between package and solder paste that could cause open solder joints or badly centered packages.
5. To improve the package placement accuracy, a bottom side optical control should be performed with a high resolution tool.
6. For assembly, a perfect supporting of the PCB (all the more on flexible PCB) is recommended during solder paste printing, pick and place and reflow soldering by using optimized tools.

## 5 Ordering information

Figure 15. Ordering information scheme

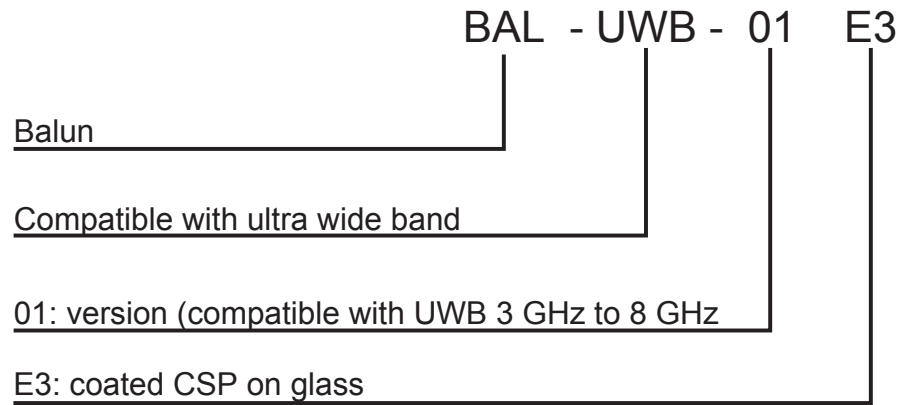


Table 8. Ordering information

Order code	Marking	Package	Weight	Base qty.	Delivery mode
BAL-UWB-01E3	TR	Bumpless CSP	2.16 mg	5000	Tape and reel (7")

## Revision history

**Table 9. Document revision history**

Date	Version	Changes
04-Apr-2019	1	Initial release.
18-Dec-2020	2	Updated <a href="#">Table 2</a> .

**IMPORTANT NOTICE – PLEASE READ CAREFULLY**

STMicroelectronics NV and its subsidiaries (“ST”) reserve the right to make changes, corrections, enhancements, modifications, and improvements to ST products and/or to this document at any time without notice. Purchasers should obtain the latest relevant information on ST products before placing orders. ST products are sold pursuant to ST’s terms and conditions of sale in place at the time of order acknowledgement.

Purchasers are solely responsible for the choice, selection, and use of ST products and ST assumes no liability for application assistance or the design of Purchasers’ products.

No license, express or implied, to any intellectual property right is granted by ST herein.

Resale of ST products with provisions different from the information set forth herein shall void any warranty granted by ST for such product.

ST and the ST logo are trademarks of ST. For additional information about ST trademarks, please refer to [www.st.com/trademarks](http://www.st.com/trademarks). All other product or service names are the property of their respective owners.

Information in this document supersedes and replaces information previously supplied in any prior versions of this document.

© 2020 STMicroelectronics – All rights reserved