

IEC Appliance Inlet C14 with Filter, Fuseholder 1-pole, Line Switch 2-pole



Screw-on mounting  
 from front side  
 Aluminum



Screw-on mounting  
 from front side  
 Nickel plated steel



See below:  
[Approvals and Compliances](#)

**Description**

- Panel mount :  
 Screw-on mounting front side
- 4 Functions :  
 Appliance Inlet Protection class I , Line Switch 2-pole , Fuseholder for fuse-links 5 x 20 mm 1-pole , Line-filter in standard version
- Quick connect terminals 6.3 x 0.8 mm

**Characteristics**

- Compact design with optimal shielding
- All single elements are already wired
- Plug removal necessary for fuse-link replacement
- With EMC-shield
- Suitable for use in medical equipment according to IEC/UL 60601-1 (1 MOOP, 1 MOPP)  
 For applications according IEC/UL 62368-1 we recommend variants with bleed resistor

**Other versions on request**

- Medical Version (M80)

**References**

Alternative: version with 2-stage filter [FKHD](#)  
 We recommend for new applications the type [DD12](#)

**Weblinks**

[pdf data sheet](#), [html datasheet](#), [General Product Information](#), [Approvals](#), [Distributor-Stock-Check](#), [Accessories](#), [Detailed request for product](#)

**Technical Data**

Ratings IEC	1 - 10A @ Ta 40 °C / 250VAC; 50Hz
Ratings UL/CSA	1 - 10A @ Ta 40 °C / 250VAC; 60Hz
Leakage Current	standard < 0.25mA (250V / 60Hz)
Dielectric Strength	> 1.7kVDC between L-N > 2.7kVDC between L/N-PE Test voltage (2 sec)
Allowable Operation Temperature	-25°C to 85°C
Climatic Category	25/085/21 acc. to IEC 60068-1
IP-Protection	front side IP40 acc. to IEC 60529
Protection Class	Suitable for appliances with protection class I acc. to IEC 61140
Terminal	Quick connect terminals 6.3 x 0.8 mm
Panel Thickness S	Screw: max 8 mm Mounting screw torque max 0.5Nm
Material: Housing	Thermoplastic, black, UL 94V-0

Appliance inlet/-outlet	C14 acc. to IEC 60320-1, UL 498, CSA C22.2 no. 42 (for cold conditions) pin-temperature 70 °C, 10A, Protection Class I
Fuseholder	1-pole, Shocksafe category PC2 acc. to IEC 60127-6, for fuse-links 5 x 20mm
Rated Power Acceptance @ Ta 23 °C	5 x 20: 1.6W (1 pole)
Power Acceptance @ Ta > 23°C	Admissible power acceptance at higher ambient temperature see derating curves
Line Switch	2-pole, non-illuminated, acc. to IEC 61058-1 <a href="#">Technical Details</a>
Line Filter	Standard version, IEC 60939, UL 1283, CSA C22.2 no. 8 <a href="#">Technical Details</a>
MTBF	> 1'700'000h acc. to MIL-HB-217 F

**Approvals and Compliances**



Detailed information on product approvals, code requirements, usage instructions and detailed test conditions can be looked up in [Details about Approvals](#)

SCHURTER products are designed for use in industrial environments. They have approvals from independent testing bodies according to national and international standards. Products with specific characteristics and requirements such as required in the automotive sector according to IATF 16949, medical technology according to ISO 13485 or in the aerospace industry can be offered exclusively with customer-specific, individual agreements by SCHURTER.

## Approvals









The approval mark is used by the testing authorities to certify compliance with the safety requirements placed on electronic products.

Approval Reference Type: FKH

Approval Logo	Certificates	Certification Body	Description
	<a href="#">VDE Approvals</a>	VDE	Certificate Number: 40004665
	<a href="#">UL Approvals</a>	UL	UL File Number: E72928



## Product standards

Product standards that are referenced

Organization	Design	Standard	Description
	Designed according to	IEC 60320-1	Appliance couplers for household and similar general purposes
	Designed according to	IEC 60939	Passive filters for suppressing electromagnetic interference
	Designed according to	IEC 60127-6	Miniature fuses. Part 6. Fuse-holders for miniature fuse-links
	Designed according to	IEC 61058-1	Switches for appliances. Part 1. General requirements
	Designed according to	UL 498	Standard for Attachment Plugs and Receptacles
	Designed according to	UL 1283	Electromagnetic interference filters
	Designed according to	CSA C22.2 no. 42	General Use Receptacles, Attachment Plugs, and Similar Wiring Devices
	Designed according to	CSA C22.2 no. 8	Electromagnetic interference (EMI) filters







## Application standards

Application standards where the product can be used

Organization	Design	Standard	Description
	Designed for applications acc.	IEC/UL 62368-1	Audio/video, information and communication technology equipment - Part 1: Safety requirements
	Designed for applications acc.	IEC 60601-1	Medical electrical equipment - Part 1: General requirements for basic safety and essential performance
	Designed for applications acc.	IEC 60335-1	Safety of electrical appliances for household and similar purposes. Meets the requirements for appliances in unattended use. This includes the enhanced requirements of glow wire tests acc. to IEC 60695-2-11 or -12 & -13.

## Compliances

The product complies with following Guide Lines

Identification	Details	Initiator	Description
	<a href="#">CE declaration of conformity</a>	SCHURTER AG	The CE marking declares that the product complies with the applicable requirements laid down in the harmonisation of Community legislation on its affixing in accordance with EU Regulation 765/2008.
	<a href="#">UKCA declaration of conformity</a>	SCHURTER AG	The UKCA marking declares that the product complies with the applicable requirements laid down in the British Amendment of Regulation (EC) 765/2008.
	RoHS	SCHURTER AG	Directive RoHS 2011/65/EU, Amendment (EU) 2015/863
	China RoHS	SCHURTER AG	The law SJ / T 11363-2006 (China RoHS) has been in force since 1 March 2007. It is similar to the EU directive RoHS.
	REACH	SCHURTER AG	On 1 June 2007, Regulation (EC) No 1907/2006 on the Registration, Evaluation, Authorization and Restriction of Chemicals 1 (abbreviated as "REACH") entered into force.
	White Paper Glow wire test	SCHURTER AG	Meets the requirements of IEC 60335-1 for appliances in unattended use. This includes the enhanced requirements of glow wire tests acc. to IEC 60695-2-11 or -12 & -13.
	Medical Equipment	SCHURTER AG	Suitable for use in medical equipment according to IEC/UL 60601-1 (1 MOOP, 1 MOPP)

Dimension [mm]

Case 45

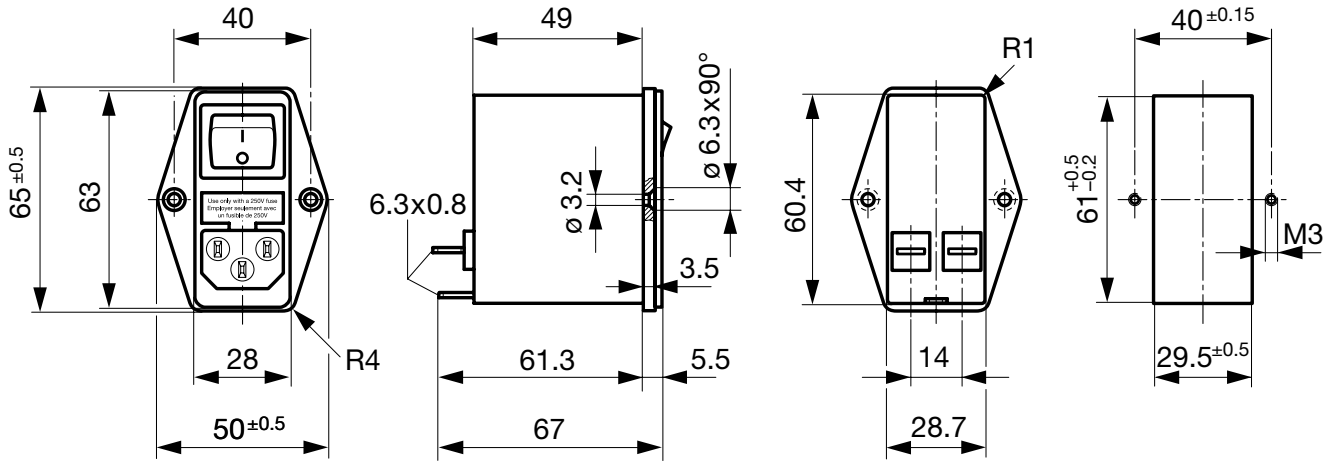

Case 50

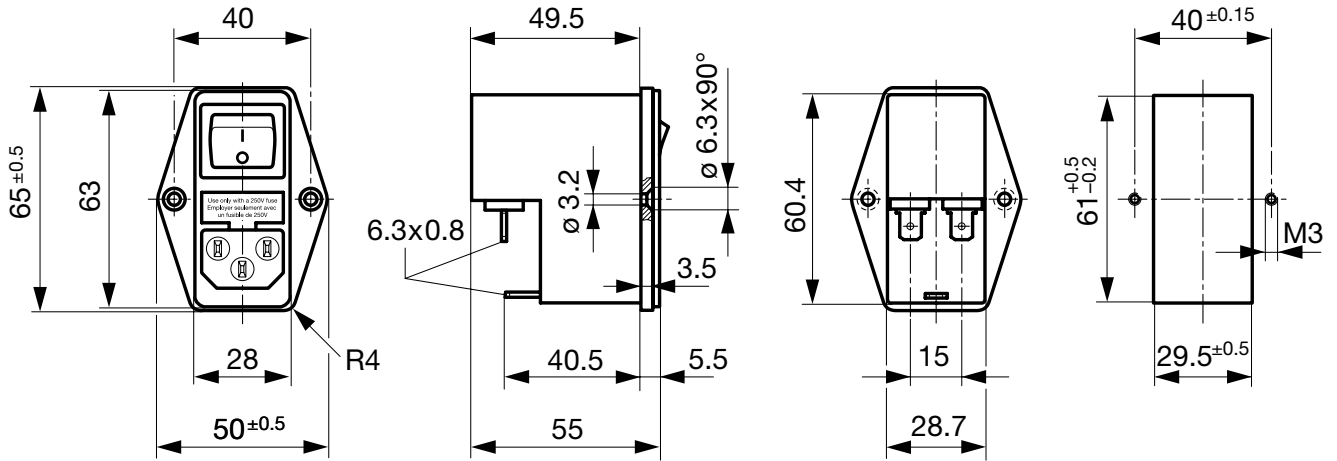

Technical Data of Filter-Components

Rated Current [A]	Filter-Type	Inductances L [mH]	Capacitance CX [nF]	Capacitance CY [nF]	R [MΩ]
1	Standard version	2 x 10	68	2.2	1
2	Standard version	2 x 4	68	2.2	1
4	Standard version	2 x 1.5	68	2.2	1
6	Standard version	2 x 0.8	68	2.2	1
10	Standard version	2 x 0.3	68	2.2	1
1	Medical Version (M5)	2 x 10	68	-	1
2	Medical Version (M5)	2 x 4	68	-	1
4	Medical Version (M5)	2 x 1.5	68	-	1
6	Medical Version (M5)	2 x 0.8	68	-	1
10	Medical Version (M5)	2 x 0.3	68	-	1

Diagrams

Standard version

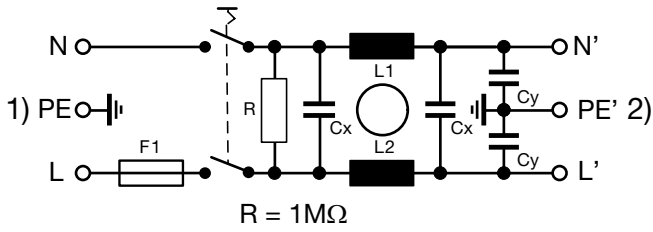

1) Line  
 2) Load

Medical Version (M5)

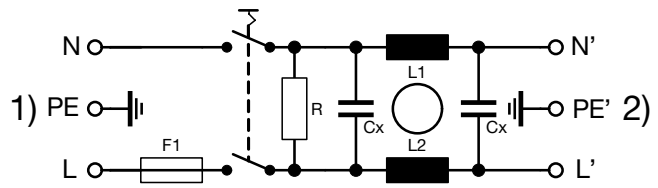

1) Line  
 2) Load

Derating Curves

1-pole



Attenuation Loss

----- 50Ω differential mode \_\_\_\_\_ 50Ω common mode

Standard version

1 A

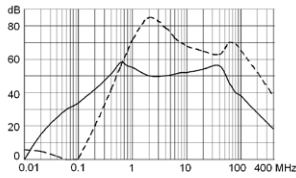

2 A



4 A

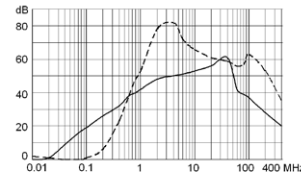

6 A

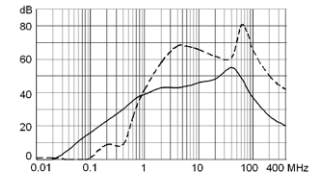

10 A

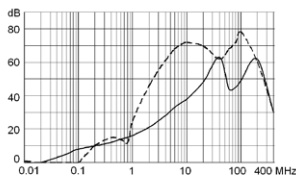

Medical version (M5)

1 A

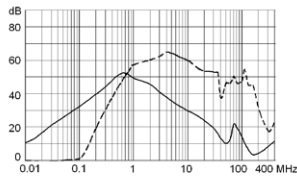

2 A

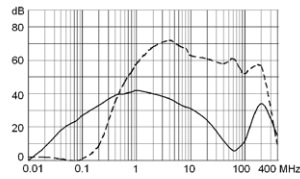

4 A

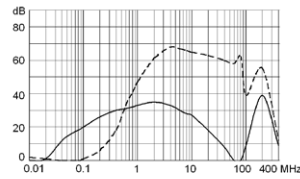

6 A

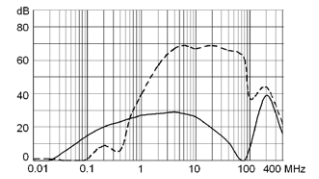

10 A

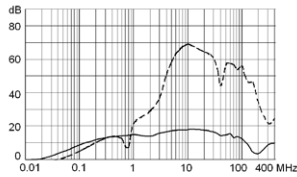

All Variants

Type	Rated Current [A]	Filter-Type	Fuseholder	Line Switch	Housing	Material: Housing	Order Number
FKH	1	Standard version	1-pole	2-pole	45	Aluminum	4304.4041
FKH	2	Standard version	1-pole	2-pole	45	Aluminum	4304.4042
FKH	4	Standard version	1-pole	2-pole	45	Aluminum	4304.4043
FKH	6	Standard version	1-pole	2-pole	45	Aluminum	4304.4044
FKH	10	Standard version	1-pole	2-pole	45	Aluminum	4304.4045
FKH	1	Medical Version (M5)	1-pole	2-pole	45	Aluminum	4304.4046
FKH	2	Medical Version (M5)	1-pole	2-pole	45	Aluminum	4304.4047
FKH	4	Medical Version (M5)	1-pole	2-pole	45	Aluminum	4304.4048
FKH	6	Medical Version (M5)	1-pole	2-pole	45	Aluminum	4304.4049
FKH	10	Medical Version (M5)	1-pole	2-pole	45	Aluminum	4304.4050
FKH	1	Standard version	1-pole	2-pole	50	Nickel plated steel	4304.4001
FKH	2	Standard version	1-pole	2-pole	50	Nickel plated steel	4304.4002
FKH	4	Standard version	1-pole	2-pole	50	Nickel plated steel	4304.4003
FKH	6	Standard version	1-pole	2-pole	50	Nickel plated steel	4304.4004
FKH	10	Standard version	1-pole	2-pole	50	Nickel plated steel	4304.4005

Most Popular.

Availability for all products can be searched real-time: <https://www.schurter.com/en/Stock-Check/Stock-Check-SCHURTER>

Packaging unit

10 Pcs

Accessories

Description



Assorted Covers  
 Rear Cover

0859.0074



RC320  
 Rear Cover for Power Entry Module

Mating Outlets/Connectors

Category / Description

Appliance Outlet Overview complete



4787, Mounting: Screw-on mounting, Appliance Outlet: IEC Solder terminals, 10 A, Suitable for appliances with protection class I

4787

4788, Mounting: Snap-in version, Appliance Outlet: IEC Solder / Quick Connect, 10 A, Suitable for appliances with protection class I

4788

IEC Appliance Outlet F or H, Screw-on Mounting, Front Side, Solder, PCB or Quick-connect Terminal

5091

Connector Overview complete



4782 Mounting: Power Cord, 3 x 1 mm<sup>2</sup> / 3 x 18 AWG, Cable, Connector: IEC C13

4782

4785 Mounting: Power Cord, 3 x 1 mm<sup>2</sup> / 3 x 18 AWG, Cable, Connector: IEC C13

4785

4300-06 Mounting: Power Cord, 3 x 1 mm<sup>2</sup> / 3 x 18 AWG, Cable, Connector: IEC C13

4300-06

4781 Mounting: Power Cord, Cable, Connector: IEC C15

4781

4784 Mounting: Power Cord, 3 x 1 mm<sup>2</sup> / 3 x 18 AWG, Cable, Connector: IEC C15

4784

...