

Metallized Polyester (PET) SMD Film Capacitors with Box Encapsulation.
Capacitances from 0.01 μF to 6.8 μF . Rated Voltages from 63 VDC to 1000 VDC.
Size Codes from 1812 to 6054.

Special Features

- Size codes 1812, 2220, 2824, 4030, 5040 and 6054 with PET and encapsulated
- Operating temperature up to 125° C
- Self-healing
- Suitable for lead-free soldering
- According to RoHS 2011/65/EU

Typical Applications

For general DC-applications e.g.

- By-pass
- Blocking
- Coupling and decoupling
- Timing

Construction

Dielectric:

Polyethylene-terephthalate (PET) film

Capacitor electrodes:

Vacuum-deposited

Internal construction:

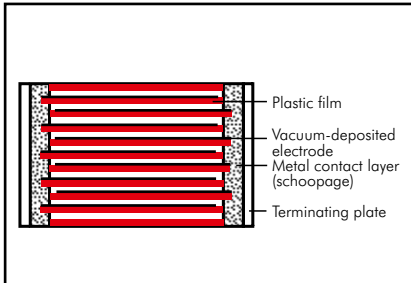

Encapsulation:

Solvent-resistant, flame-retardant plastic case, UL 94 V-0

Terminations:

Tinned plates.

Marking:

Box colour: Black.

Electrical Data

Capacitance range:

0.01 μF to 6.8 μF

Rated voltages:

63 VDC, 100 VDC, 250 VDC, 400 VDC, 630 VDC, 1000 VDC

Capacitance tolerances:

$\pm 20\%$, $\pm 10\%$ ($\pm 5\%$ available subject to special enquiry)

Operating temperature range:

-55°C to $+125^\circ\text{C}$

Climatic test category:

55/100/21 according to IEC

for size codes 1812 to 2824

55/100/56 according to IEC

for size codes 4030 to 6054

Insulation resistance at $+20^\circ\text{C}$:

U_r	U_{test}	$C \leq 0.33 \mu\text{F}$	$0.33 \mu\text{F} < C \leq 6.8 \mu\text{F}$
63 VDC 100 VDC	50 V 100 V	$\geq 3.75 \times 10^3 \text{ M}\Omega$	$\geq 1250 \text{ sec (M}\Omega \times \mu\text{F)}$
$\geq 250 \text{ VDC}$	100 V	$\geq 1 \times 10^4 \text{ M}\Omega$	$\geq 3000 \text{ sec (M}\Omega \times \mu\text{F)}$

Measuring time: 1 min.

Dissipation factors at $+20^\circ\text{C}$: $\tan \delta$

at f	$C \leq 0.1 \mu\text{F}$	$0.1 \mu\text{F} < C \leq 1.0 \mu\text{F}$	$C > 1.0 \mu\text{F}$
1 kHz	$\leq 8 \times 10^{-3}$	$\leq 8 \times 10^{-3}$	$\leq 10 \times 10^{-3}$
10 kHz	$\leq 15 \times 10^{-3}$	$\leq 15 \times 10^{-3}$	-
100 kHz	$\leq 30 \times 10^{-3}$	-	-

Maximum pulse rise time:

Capacitance μF	max. pulse rise time V/ μsec					
	63 VDC	100 VDC	250 VDC	400 VDC	630 VDC	1000 VDC
0.01 ... 0.022	30	35	40	35	40	50
0.033 ... 0.068	20	20	40	21	25	32
0.1 ... 0.22	10	10	12	14	17	-
0.33 ... 0.68	8	6	9	10	-	-
1.0 ... 2.2	3.5	4	7	-	-	-
3.3 ... 6.8	3	3	-	-	-	-

Dip Solder Test/Processing

Resistance to soldering heat:

Test Tb in accordance with DIN IEC

60068-2-58/DIN EN 60384-19.

Soldering bath temperature max. 260°C .

Soldering duration max. 5 sec.

Change in capacitance $\Delta C/C < 5\%$.

Soldering process:

Re-flow soldering (see temperature/time graphs page 13).

Packing

Available taped and reeled in blister pack.

Detailed taping information and graphs at the end of the catalogue.

For further details and graphs please refer to Technical Information.

Continuation

General Data

Capacitance	63 VDC/40 VAC*			100 VDC/63 VAC*			250 VDC/160 VAC*		
	Size code	H ± 0.3	Part number	Size code	H ± 0.3	Part number	Size code	H ± 0.3	Part number
0.01 µF	1812	3.0	SMDTC02100KA00_____	1812	3.0	SMDTD02100KA00_____	2220	3.5	SMDTF02100QA00_____
	2220	3.5	SMDTC02100QA00_____	2220	3.5	SMDTD02100QA00_____	2824	3.0	SMDTF02100TA00_____
	2824	3.0	SMDTC02100TA00_____	2824	3.0	SMDTD02100TA00_____			
0.015 "	1812	3.0	SMDTC02150KA00_____	1812	3.0	SMDTD02150KA00_____	2220	3.5	SMDTF02150QA00_____
	2220	3.5	SMDTC02150QA00_____	2220	3.5	SMDTD02150QA00_____	2824	3.0	SMDTF02150TA00_____
	2824	3.0	SMDTC02150TA00_____	2824	3.0	SMDTD02150TA00_____			
0.022 "	1812	3.0	SMDTC02220KA00_____	1812	3.0	SMDTD02220KA00_____	2220	3.5	SMDTF02220QA00_____
	2220	3.5	SMDTC02220QA00_____	2220	3.5	SMDTD02220QA00_____	2824	3.0	SMDTF02220TA00_____
	2824	3.0	SMDTC02220TA00_____	2824	3.0	SMDTD02220TA00_____			
0.033 "	1812	3.0	SMDTC02330KA00_____	1812	3.0	SMDTD02330KA00_____	2220	3.5	SMDTF02330QA00_____
	2220	3.5	SMDTC02330QA00_____	2220	3.5	SMDTD02330QA00_____	2824	3.0	SMDTF02330TA00_____
	2824	3.0	SMDTC02330TA00_____	2824	3.0	SMDTD02330TA00_____	4030	5.0	SMDTF02330VA00_____
0.047 "	1812	3.0	SMDTC02470KA00_____	1812	3.0	SMDTD02470KA00_____	2220	3.5	SMDTF02470QA00_____
	2220	3.5	SMDTC02470QA00_____	2220	3.5	SMDTD02470QA00_____	2824	3.0	SMDTF02470TA00_____
	2824	3.0	SMDTC02470TA00_____	2824	3.0	SMDTD02470TA00_____	4030	5.0	SMDTF02470VA00_____
0.068 "	1812	3.0	SMDTC02680KA00_____	1812	3.0	SMDTD02680KA00_____	2220	4.5*	SMDTF02680QB00_____
	2220	3.5	SMDTC02680QA00_____	2220	3.5	SMDTD02680QA00_____	2824	3.0	SMDTF02680TA00_____
	2824	3.0	SMDTC02680TA00_____	2824	3.0	SMDTD02680TA00_____	4030	5.0	SMDTF02680VA00_____
0.1 µF	1812	4.0*	SMDTC03100KB00_____	1812	4.0*	SMDTD03100KB00_____	2220	4.5*	SMDTF03100QB00_____
	2220	3.5	SMDTC03100QA00_____	2220	3.5	SMDTD03100QA00_____	2824	5.0	SMDTF03100TB00_____
	2824	3.0	SMDTC03100TA00_____	2824	3.0	SMDTD03100TA00_____	4030	5.0	SMDTF03100VA00_____
0.15 "	1812	4.0*	SMDTC03150KB00_____	1812	4.0	SMDTD03150KB00_____	2824	5.0	SMDTF03150TB00_____
	2220	3.5	SMDTC03150QA00_____	2220	3.5	SMDTD03150QA00_____	4030	5.0	SMDTF03150VA00_____
	2824	3.0	SMDTC03150TA00_____	2824	3.0	SMDTD03150TA00_____			
0.22 "	1812	4.0*	SMDTC03220KB00_____	1812	4.0	SMDTD03220KB00_____	2824	5.0	SMDTF03220TB00_____
	2220	3.5	SMDTC03220QA00_____	2220	3.5	SMDTD03220QA00_____	4030	5.0	SMDTF03220VA00_____
	2824	3.0	SMDTC03220TA00_____	2824	3.0	SMDTD03220TA00_____			
0.33 "	1812	4.0	SMDTC03330KB00_____	2220	4.5	SMDTD03330QB00_____	2824	5.0	SMDTF03330TB00_____
	2220	4.5*	SMDTC03330QB00_____	2824	5.0	SMDTD03330TB00_____	4030	5.0	SMDTF03330VA00_____
	2824	5.0*	SMDTC03330TB00_____	4030	5.0	SMDTD03330VA00_____	5040	6.0	SMDTF03330XA00_____
0.47 "	1812	4.0	SMDTC03470KB00_____	2220	4.5	SMDTD03470QB00_____	4030	5.0	SMDTF03470VA00_____
	2220	4.5*	SMDTC03470QB00_____	2824	5.0	SMDTD03470TB00_____	5040	6.0	SMDTF03470XA00_____
	2824	5.0*	SMDTC03470TB00_____	4030	5.0	SMDTD03470VA00_____			
0.68 "	2220	4.5	SMDTC03680QB00_____	2824	5.0	SMDTD03680TB00_____	5040	6.0	SMDTF03680XA00_____
	2824	5.0*	SMDTC03680TB00_____	4030	5.0	SMDTD03680VA00_____			
	4030	5.0	SMDTC03680VA00_____	5040	6.0	SMDTD03680XA00_____			
1.0 µF	2220	4.5	SMDTC04100QB00_____	2824	5.0	SMDTD04100TB00_____	6054	7.0	SMDTF04100YA00_____
	2824	5.0*	SMDTC04100TB00_____	4030	5.0	SMDTD04100VA00_____			
	4030	5.0	SMDTC04100VA00_____	5040	6.0	SMDTD04100XA00_____			
1.5 "	2824	5.0	SMDTC04150TB00_____	4030	5.0	SMDTD04150VA00_____			
	4030	5.0	SMDTC04150VA00_____	5040	6.0	SMDTD04150XA00_____			
2.2 "	2824	5.0	SMDTC04220TB00_____	5040	6.0	SMDTD04220XA00_____			
	4030	5.0	SMDTC04220VA00_____						
3.3 "	4030	5.0	SMDTC04330VA00_____	5040	6.0	SMDTD04330XA00_____			
4.7 "	5040	6.0	SMDTC04470XA00_____	6054	7.0	SMDTD04470YA00_____			
6.8 "	6054	7.0	SMDTC04680YA00_____						

* Version according to catalogue 2013 still available

Part number completion:

Tolerance: 20 % = M
 10 % = K
 5 % = J
 Packing: bulk = S
 Pin length: none = 00
 Taped version see page 160.

* AC voltage: $f = 50 \text{ Hz}$; $1.4 \times U_{\text{rms}} + U_{\text{DC}} \leq U_r$

Dims. in mm.

Rights reserved to amend design data without prior notification.

Continuation

General Data

Capacitance	400 VDC/200 VAC*			630 VDC/300 VAC*			1000 VDC/400 VAC*		
	Size code	H ± 0.3	Part number	Size code	H ± 0.3	Part number	Size code	H ± 0.3	Part number
0.01 μ F	2824 4030	3.0 5.0	SMDTG02100TA00_____ SMDTG02100VA00_____ SMDTG02100VA00_____ SMDTG02100VA00_____	4030	5.0	SMDTJ02100VA00_____ SMDTJ02100VA00_____ SMDTJ02100VA00_____ SMDTJ02100VA00_____			
0.015 "	2824 4030	3.0 5.0	SMDTG02150TA00_____ SMDTG02150VA00_____ SMDTG02150VA00_____ SMDTG02150VA00_____	4030	5.0	SMDTJ02150VA00_____ SMDTJ02150VA00_____ SMDTJ02150VA00_____ SMDTJ02150VA00_____	5040	6.0	SMDTO12150XA00_____ SMDTO12150XA00_____ SMDTO12150XA00_____ SMDTO12150XA00_____
0.022 "	2824 4030	5.0* 5.0	SMDTG02220TB00_____ SMDTG02220VA00_____ SMDTG02220VA00_____ SMDTG02220VA00_____	5040	6.0	SMDTJ02220XA00_____ SMDTJ02220XA00_____ SMDTJ02220XA00_____ SMDTJ02220XA00_____	5040	6.0	SMDTO12220XA00_____ SMDTO12220XA00_____ SMDTO12220XA00_____ SMDTO12220XA00_____
0.033 "	2824 4030	5.0 5.0	SMDTG02330TB00_____ SMDTG02330VA00_____ SMDTG02330VA00_____ SMDTG02330VA00_____	5040	6.0	SMDTJ02330XA00_____ SMDTJ02330XA00_____ SMDTJ02330XA00_____ SMDTJ02330XA00_____	5040	6.0	SMDTO12330XA00_____ SMDTO12330XA00_____ SMDTO12330XA00_____ SMDTO12330XA00_____
0.047 "	2824 4030	5.0 5.0	SMDTG02470TB00_____ SMDTG02470VA00_____ SMDTG02470VA00_____ SMDTG02470VA00_____	5040	6.0	SMDTJ02470XA00_____ SMDTJ02470XA00_____ SMDTJ02470XA00_____ SMDTJ02470XA00_____	6054	7.0	SMDTO12470YA00_____ SMDTO12470YA00_____ SMDTO12470YA00_____ SMDTO12470YA00_____
0.068 "	4030 5040	5.0 6.0	SMDTG02680VA00_____ SMDTG02680XA00_____ SMDTG02680XA00_____ SMDTG02680XA00_____	5040	6.0	SMDTJ02680XA00_____ SMDTJ02680XA00_____ SMDTJ02680XA00_____ SMDTJ02680XA00_____			
0.1 μ F	4030 5040	5.0 6.0	SMDTG03100VA00_____ SMDTG03100XA00_____ SMDTG03100XA00_____ SMDTG03100XA00_____	6054	7.0	SMDTJ03100YA00_____ SMDTJ03100YA00_____ SMDTJ03100YA00_____ SMDTJ03100YA00_____			
0.15 "	4030 5040	5.0 6.0	SMDTG03150VA00_____ SMDTG03150XA00_____ SMDTG03150XA00_____ SMDTG03150XA00_____	6054	7.0	SMDTJ03150YA00_____ SMDTJ03150YA00_____ SMDTJ03150YA00_____ SMDTJ03150YA00_____			
0.22 "	5040	6.0	SMDTG03220XA00_____ SMDTG03220XA00_____ SMDTG03220XA00_____ SMDTG03220XA00_____	6054	7.0	SMDTJ03220YA00_____ SMDTJ03220YA00_____ SMDTJ03220YA00_____ SMDTJ03220YA00_____			
0.33 "	5040	6.0	SMDTG03330XA00_____ SMDTG03330XA00_____ SMDTG03330XA00_____ SMDTG03330XA00_____						
0.47 "	6054	7.0	SMDTG03470YA00_____ SMDTG03470YA00_____ SMDTG03470YA00_____ SMDTG03470YA00_____						

* AC voltage: $f = 50 \text{ Hz}$; $1.4 \times U_{\text{rms}} + U_{\text{DC}} \leq U_r$

* Version according to catalogue 2013 still available

Solder pad recommendation

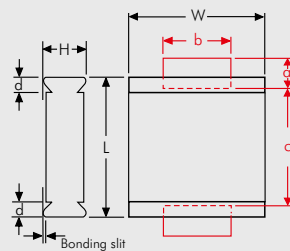

Part number completion:

Tolerance: 20 % = M

10 % = K

5 % = J

Packing: bulk = S

Pin length: none = 00

Taped version see page 160.

Dims. in mm.

Size code	L ±0.3	W ±0.3	d	a min.	b min.	c max.
1812	4.8	3.3	0.5	1.2	3.5	3.5
2220	5.7	5.1	0.5	1.2	4	4.5
2824	7.2	6.1	0.5	1.2	4	6.5
4030	10.2	7.6	0.5	2.5	6	9
5040	12.7	10.2	0.7	2.5	6	11.5
6054	15.3	13.7	0.7	2.5	6	14

Rights reserved to amend design data without prior notification.

Continuation

Impedance change with frequency
(general guide).

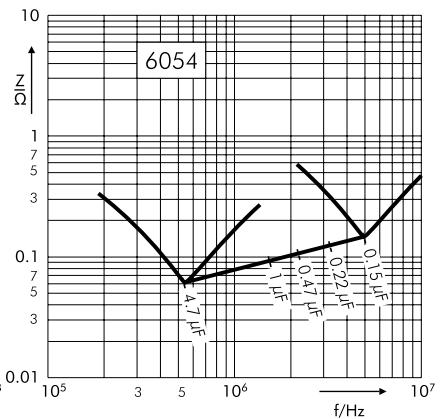
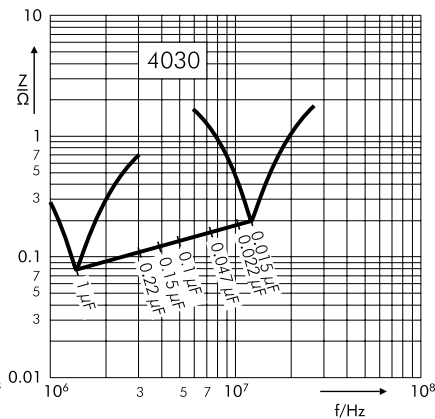
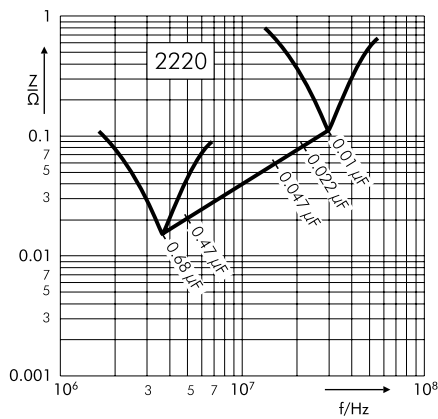
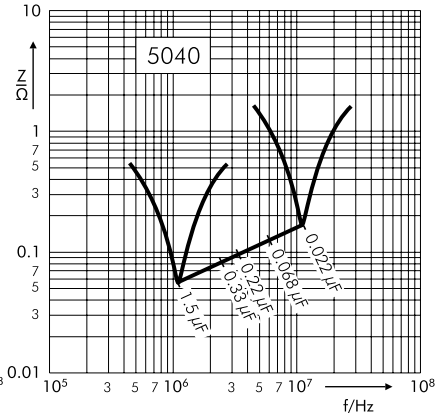
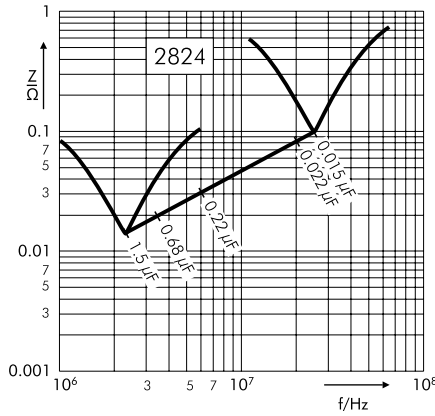
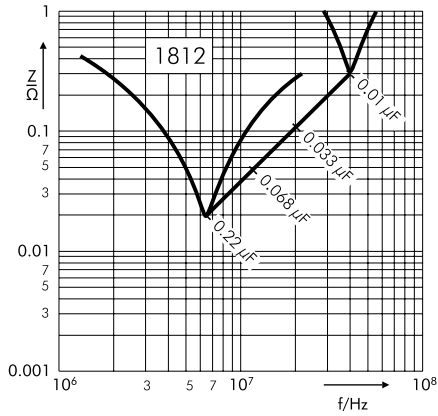

Permissible AC voltage in relation to frequency at 10° C internal temperature rise
(general guide).

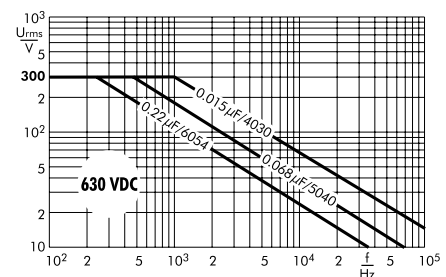
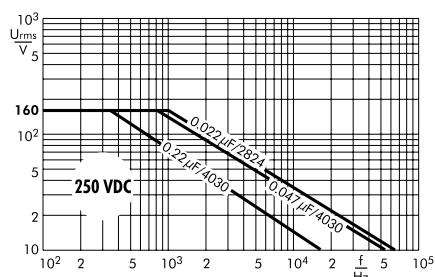
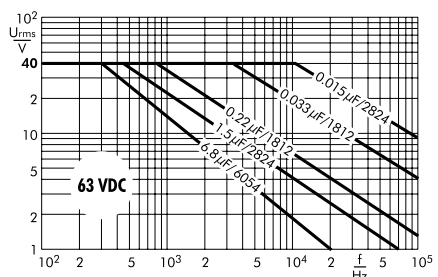
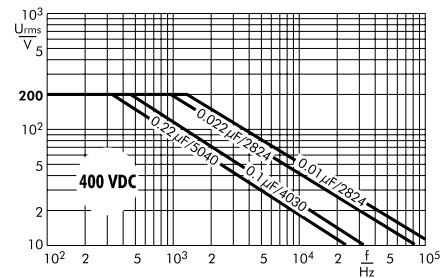
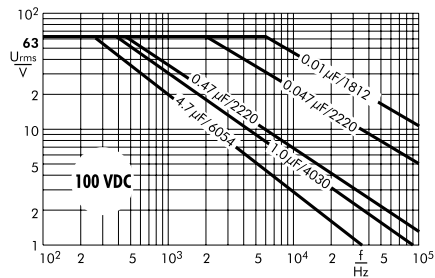

Recommendation for Processing and Application of SMD Capacitors



Layout Form

The components can generally be positioned on the carrier material as desired. In order to prevent soldering shadows or ensure regular temperature distribution, extreme concentration of the components should be avoided. In practice, it has proven best to keep a minimum distance of the soldering surfaces between two WIMA SMDs of twice the height of the components.

Solder Pad Recommendation

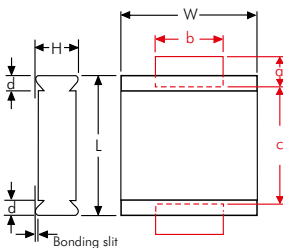

Size code	L ± 0.3	W ± 0.3	d	a min.	b min.	c max.
1812	4.8	3.3	0.5	1.2	3.5	3.5
2220	5.7	5.1	0.5	1.2	4	4.5
2824	7.2	6.1	0.5	1.2	4	6.5
4030	10.2	7.6	0.5	2.5	6	9
5040	12.7	10.2	0.7	2.5	6	11.5
6054	15.3	13.7	0.7	2.5	6	14

The solder pad size recommendations given for each individual series are to be understood as minimum dimensions which can at any time be adjusted to the layout form.

Processing

The processing of SMD components

- assembling
- soldering
- electrical final inspection/calibrating

must be regarded as a complete process. The soldering of the printed circuit board, for example, can constitute considerable stress on all the electronic components. The manufacturer's instructions on the processing of the components are mandatory.

Soldering Process

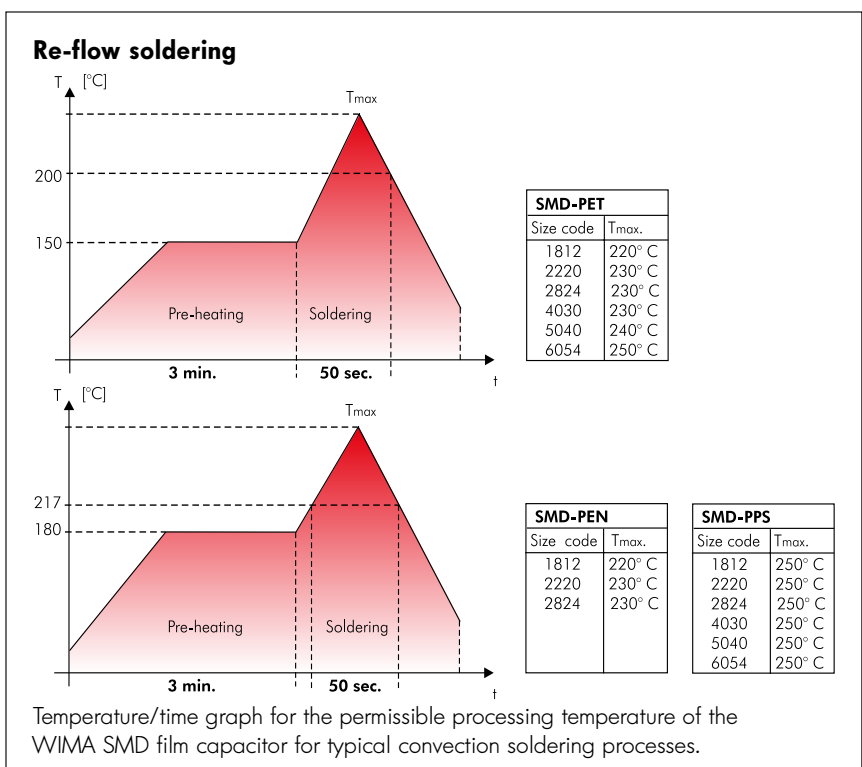

Due to versatile procedures exact processing parameters for re-flow soldering processes cannot be specified. The graph depicted is to be understood as a recommendation to help establishing a suitable soldering profile fulfilling the requirements

in practice at the user. During processing a max. temperature of $T=210^{\circ}\text{C}$ inside the component should not be exceeded. Due to the differing heat absorption the length of the soldering process should be kept as short as possible for smaller size codes.

SMD Handsoldering

WIMA SMD capacitors with plastic film dielectric are generally suitable for hand-soldering, e. g. for lab purposes, with a soldering iron where, however, similar to automated soldering processes, a certain duration and temperature should not be exceeded. These parameters are dependent on the physical size of the components and the relevant heat absorption involved.

The below data are to be regarded as guideline values and should serve to avoid damage to the dielectric caused by excessive heat during the soldering process. The soldering quality depends on the tool used and on the skill and experience of the person with the soldering iron in hand.

Size code	Temperature °C / °F	Time duration
1812	250 / 482	2 sec plate 1 / 5 sec off / 2 sec plate 2
2220	250 / 482	3 sec plate 1 / 5 sec off / 3 sec plate 2
2824	260 / 500	3 sec plate 1 / 5 sec off / 3 sec plate 2
4030	260 / 500	5 sec plate 1 / 5 sec off / 5 sec plate 2
5040	260 / 500	5 sec plate 1 / 5 sec off / 5 sec plate 2
6054	260 / 500	5 sec plate 1 / 5 sec off / 5 sec plate 2

Recommendation for Processing and Application of SMD Capacitors (Continuation)

Solder Paste

To achieve reliable soldering results one of the following solder alloys have from case to case proven being workable:

Lead free solder paste

Sn - Bi
Sn - Zn (Bi)
Sn - Ag - Cu (suitable for SMD-PET 5040/6054, SMD-PEN and SMD-PPS)

Solder paste with lead

Sn - Pb - Ag (Sn60-Pb40-A, Sn63-Pb37-A)

Washing

WIMA SMD components with plastic encapsulation - like all other components of similar construction irrespective of the make - cannot be regarded as hermetically sealed. Due to today's common washing substances, e. g. on aqueous basis instead of the formerly used halogenated hydrocarbons, with enhanced washing efficiency it became obvious that assembled SMD capacitors may show an impermissibly high deviation of the electrical parameters after a corresponding washing process. Hence it is recommended to refrain from applying industrial washing processes for WIMA SMD capacitors in order to avoid possible damages.

Initial Operation/Calibration

Due to the stress which the components are subjected to during processing, reversible parameter changes occur in almost all electronic components. The capacitance recovery accuracy to be expected with careful processing is within a scope of

$$|\Delta C/C| \leq 5 \%$$

For the initial operation of the device a minimum storage time of

$$t \geq 24 \text{ hours}$$

is to be taken into account. With calibrated devices or when the application is largely dependent on capacitance it is

advisable to prolong the storage time to

$$t \geq 10 \text{ days}$$

In this way ageing effects of the capacitor structure can be anticipated. Parameter changes due to processing are not to be expected after this period of time

Humidity Protection Bags

Taped WIMA SMD capacitors are shipped in humidity protection bags according to JEDEC standard (ESD/EMI-shield/water-vapour proof).

Under controlled conditions the components can be stored two years and more in the originally sealed bag. Opened packing units should immediately be used up for processing. If storage is necessary the opened packing units should be stored air-tight in the original plastic bag.

Reliability

Taking account of the manufacturer's guidelines and compatible processing, the WIMA SMD stand out for the same high quality and reliability as the analogous through-hole WIMA series. The technology of metallized film capacitors used e.g. in WIMA SMD-PET achieves the best values for all fields of application. The expected value is about:

$$\lambda_0 \leq 2 \text{ fit}$$

Furthermore the production of all WIMA components is subject to the regulations laid down by ISO 9001:2015 as well as the guidelines for component specifications set out by IEC quality assessment system (IECQ) for electronic components.

Electrical Characteristics and Fields of Application

Basically the WIMA SMD series have the same electrical characteristics as the analogous through-hole WIMA capacitors. Compared to ceramic or tantalum dielectrics WIMA SMD capacitors have a

number of other outstanding qualities:

- favourable pulse rise time
- low ESR
- low dielectric absorption
- available in high voltage series
- large capacitance spectrum
- stand up to high mechanical stress
- good long-term stability

As regards technical performance as well as quality and reliability, the WIMA SMD series offer the possibility to cover nearly all applications of conventionally through-hole film capacitors with SMD components. Furthermore, the WIMA SMD series can now be used for all the demanding capacitor applications for which, in the past, the use of through-hole components was mandatory:

- measuring techniques
- oscillator circuits
- differentiating and integrating circuits
- A/D or D/A transformers
- sample and hold circuits
- automotive electronics

With the WIMA SMD programme available today, the major part of all plastic film capacitors can be replaced by WIMA SMD components. The field of application ranges from standard coupling capacitors to use in switch-mode power supplies as filter or charging capacitors with high voltage and capacitance values, as well as in telecommunications e.g. the well-known telephone capacitor $1 \mu\text{F}/250\text{VDC}$.



Blister Tape Packaging and Packing Units of the WIMA SMD Capacitors

Tape reel:

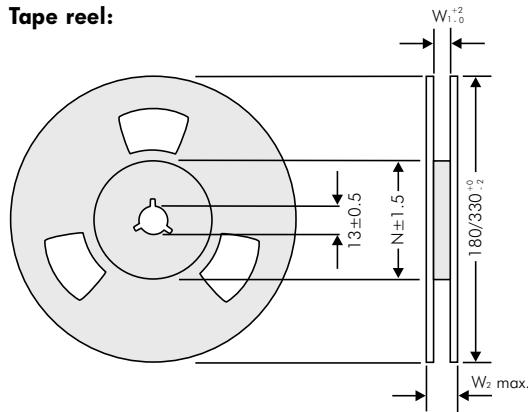

Tape advance and return:

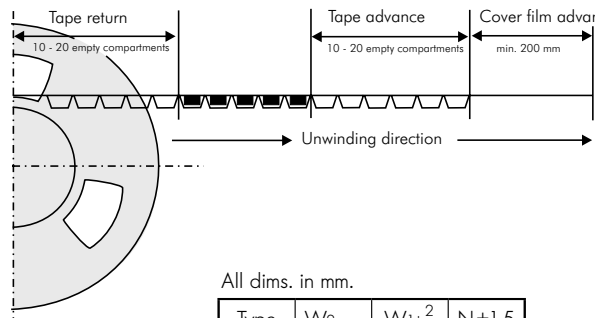

All dims. in mm.

Type	W _{2max}	W _{1±0.2}	N±1.5
1812	19	12.4	62
2220	19	12.4	62
2824	19	12.4	62
4030	22.4	16.4	60
5040	30.4	24.4	90
6054	30.4	24.4	90

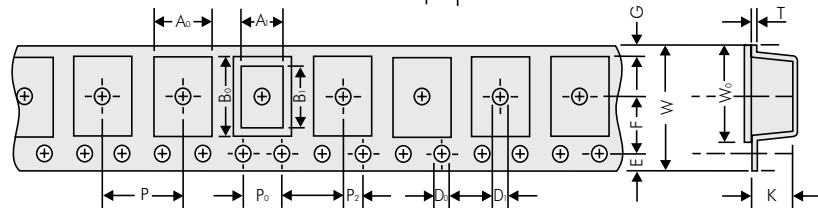

Packing units

Size Code 1812		A ₀ ±0.1	A ₁	B ₀ ±0.1	B ₁	D ₀ +0.1 -0	D ₁ +0.1 -0	P ±0.1	P ₀ * ±0.1	P ₂ ±0.05	E ±0.1	F ±0.05	G	W ±0.3	W ₀ ±0.2	K ±0.1	T ±0.1
Box size	Code																
4.8x3.3x3	KA	3.55	3.3	5.1	4.8	ø1.5	ø1.5	8	4	2	1.75	5.5	2.2	12	9.5	3.4	0.3
4.8x3.3x4	KB	3.55	3.3	5.1	4.8	ø1.5	ø1.5	8	4	2	1.75	5.5	2.2	12	9.5	4.4	0.3

taped Reel 180 mm ø	taped Reel 330 mm ø	bulk Standard
700	2500	3000
500	2000	3000

Size Code 2220		A ₀ ±0.1	A ₁	B ₀ ±0.1	B ₁	D ₀ +0.1 -0	D ₁ +0.1 -0	P ±0.1	P ₀ * ±0.1	P ₂ ±0.05	E ±0.1	F ±0.05	G	W ±0.3	W ₀ ±0.2	K ±0.1	T ±0.1
Box size	Code																
5.7x5.1x3.5	QA	6.3	5.7	5.6	5.1	ø1.5	ø1.5	8	4	2	1.75	5.5	1.95	12	9.5	3.7	0.3
5.7x5.1x4.5	QB	6.3	5.7	5.6	5.1	ø1.5	ø1.5	8	4	2	1.75	5.5	1.95	12	9.5	4.7	0.3

taped Reel 180 mm ø	taped Reel 330 mm ø	bulk Standard
500	1800	3000
400	1500	3000

Size Code 2824		A ₀ ±0.1	A ₁	B ₀ ±0.1	B ₁	D ₀ +0.1 -0	D ₁ +0.1 -0	P ±0.1	P ₀ * ±0.1	P ₂ ±0.05	E ±0.1	F ±0.05	G	W ±0.3	W ₀ ±0.2	K ±0.1	T ±0.1
Box size	Code																
7.2x6.1x3	TA	6.6	6.1	7.7	7.2	ø1.5	ø1.5	12	4	2	1.75	5.5	0.9	12	9.5	3.4	0.3
7.2x6.1x5	TB	6.6	6.1	7.7	7.2	ø1.5	ø1.5	12	4	2	1.75	5.5	0.9	12	9.5	5.4	0.4

taped Reel 330 mm ø	bulk Standard
1500	2000
750	2000

Code	A ₀ ±0.1	A ₁	B ₀ ±0.1	B ₁	D ₀ +0.1 -0	D ₁ +0.1 -0	P ±0.1	P ₀ * ±0.1	P ₂ ±0.05	E ±0.1	F ±0.05	G	W ±0.3	W ₀ ±0.2	K ±0.1	T ±0.1	
Size Code 4030	VA	10.7	10.2	8.1	9.1	ø1.5	ø1.5	16	4	2	1.75	7.5	1.9	16	13.3	5.5	0.3
Size Code 5040	XA	13.5	12.7	11	11.5	ø1.5	ø1.5	16	4	2	1.75	11.5	4.7	24	21.3	6.5	0.3
Size Code 6054	YA	17.0	16.5	15.6	15.0	ø1.5	ø1.5	20	4	2	1.75	11.5	2.95	24	21.3	7.5	0.3

taped Reel 330 mm ø	bulk Standard
775	2000
600	1000
450	500

* cumulative after 10 steps ± 0.2 mm max.
Samples and pre-production needs on request or 1 Reel minimum.

Part number codes for SMD packing

W (Blister)	ø in mm	Code
12	180	P
12	330	Q
16	330	R
24	330	T

Bulk Standard	S
---------------	----------



A WIMA part number consists of 18 digits and is composed as follows:

- Field 1 - 4: Type description
- Field 5 - 6: Rated voltage
- Field 7 - 10: Capacitance
- Field 11 - 12: Size and PCM
- Field 13 - 14: Version code (e.g. Snubber versions)
- Field 15: Capacitance tolerance
- Field 16: Packing
- Field 17 - 18: Pin length (untaped)

1	2	3	4	5	6	7	8	9	10	11	12	13	14	15	16	17	18
M	K	S	2	C	0	2	1	0	0	1	A	0	0	M	S	S	D
MKS 2				63 VDC		0.01 µF			2.5x6.5x7.2		-		20%	bulk	6 -2		

<p>Type description:</p> <p>SMD-PET = SMDT SMD-PEN = SMDN SMD-PPS = SMDI FKP 02 = FKPO MKS 02 = MKS0 FKS 2 = FKS2 FKP 2 = FKP2 FKS 3 = FKS3 FKP 3 = FKP 3 MKS 2 = MKS2 MKP 2 = MKP2 MKS 4 = MKS4 MKP 4 = MKP4 MKP 10 = MKP1 FKP 4 = FKP4 FKP 1 = FKP1 MKP-X2 = MKX2 MKP-X1 R = MKX1 MKP-Y2 = MKY2 MP 3-X2 = MPX2 MP 3-X1 = MPX1 MP 3-Y2 = MPY2 MP 3R-Y2 = MPRY MKP 4F = MKPF Snubber MKP = SNMP Snubber FKP = SNFP GTO MKP = GTOM DC-LINK MKP 4 = DCP4 DC-LINK MKP 6 = DCP6 DC-LINK HC = DCHC</p>	<p>Rated voltage:</p> <p>50 VDC = B0 63 VDC = C0 100 VDC = D0 250 VDC = F0 400 VDC = G0 450 VDC = H0 520 VDC = H2 600 VDC = I0 630 VDC = J0 700 VDC = K0 800 VDC = L0 850 VDC = M0 900 VDC = N0 1000 VDC = O1 1100 VDC = P0 1200 VDC = Q0 1250 VDC = R0 1500 VDC = S0 1600 VDC = T0 1700 VDC = TA 2000 VDC = U0 2500 VDC = V0 3000 VDC = W0 4000 VDC = X0 6000 VDC = Y0 250 VAC = 0W 275 VAC = 1W 300 VAC = 2W 305 VAC = AW 350 VAC = BW 440 VAC = 4W 500 VAC = 5W ...</p>	<p>Capacitance:</p> <p>22 pF = 0022 47 pF = 0047 100 pF = 0100 150 pF = 0150 220 pF = 0220 330 pF = 0330 470 pF = 0470 680 pF = 0680 1000 pF = 1100 1500 pF = 1150 2200 pF = 1220 3300 pF = 1330 4700 pF = 1470 6800 pF = 1680 0.01 µF = 2100 0.022 µF = 2220 0.047 µF = 2470 0.1 µF = 3100 0.22 µF = 3220 0.47 µF = 3470 1 µF = 4100 2.2 µF = 4220 4.7 µF = 4470 10 µF = 5100 22 µF = 5220 47 µF = 5470 100 µF = 6100 220 µF = 6220 1000 µF = 7100 1500 µF = 7150 ...</p>	<p>Size:</p> <p>4.8x3.3x3 Size 1812 = KA 4.8x3.3x4 Size 1812 = KB 5.7x5.1x3.5 Size 2220 = QA 5.7x5.1x4.5 Size 2220 = QB 7.2x6.1x3 Size 2824 = TA 7.2x6.1x5 Size 2824 = TB 10.2x7.6x5 Size 4030 = VA 12.7x10.2x6 Size 5040 = XA 15.3x13.7x7 Size 6054 = YA 2.5x7x4.6 PCM 2.5 = 0B 3x7.5x4.6 PCM 2.5 = 0C 2.5x6.5x7.2 PCM 5 = 1A 3x7.5x7.2 PCM 5 = 1B 2.5x7x10 PCM 7.5 = 2A 3x8.5x10 PCM 7.5 = 2B 3x9x13 PCM 10 = 3A 4x9x13 PCM 10 = 3C 5x11x18 PCM 15 = 4B 6x12.5x18 PCM 15 = 4C 5x14x26.5 PCM 22.5 = 5A 6x15x26.5 PCM 22.5 = 5B 9x19x31.5 PCM 27.5 = 6A 11x21x31.5 PCM 27.5 = 6B 9x19x41.5 PCM 37.5 = 7A 11x22x41.5 PCM 37.5 = 7B 19x31x56 PCM 48.5 = 8D 25x45x57 PCM 52.5 = 9D ...</p> <p>Version code:</p> <p>Standard = 00 Version A1 = 1A Version A1.1.1 = 1B Version A2 = 2A ...</p>	<p>Tolerance:</p> <p>±20% = M ±10% = K ±5% = J ±2.5% = H ±1% = E ...</p> <p>Packing:</p> <p>AMMO H16.5 340x340 = A AMMO H16.5 490x370 = B AMMO H18.5 340x340 = C AMMO H18.5 490x370 = D REEL H16.5 360 = F REEL H16.5 500 = H REEL H18.5 360 = I REEL H18.5 500 = J ROLL H16.5 = N ROLL H18.5 = O BLISTER W12 180 = P BLISTER W12 330 = Q BLISTER W16 330 = R BLISTER W24 330 = T Bulk/TPS Standard = S ...</p> <p>Pin length (untaped)</p> <p>3.5 ±0.5 = C9 6 -2 = SD 16 ±1 = P1 ...</p> <p>Pin length (taped)</p> <p>none = 00</p>
---	---	---	--	---

The data on this page is not complete and serves only to explain the part number system. Part number information is listed on the pages of the respective WIMA range.