



Mounting flange

BF 30

- Retainer for all cylindrical sensors with M30 thread
- Simple installation and exact setting
- Large sensing range (max. 18 mm)

Mounting flange, 30 mm

Dimensions

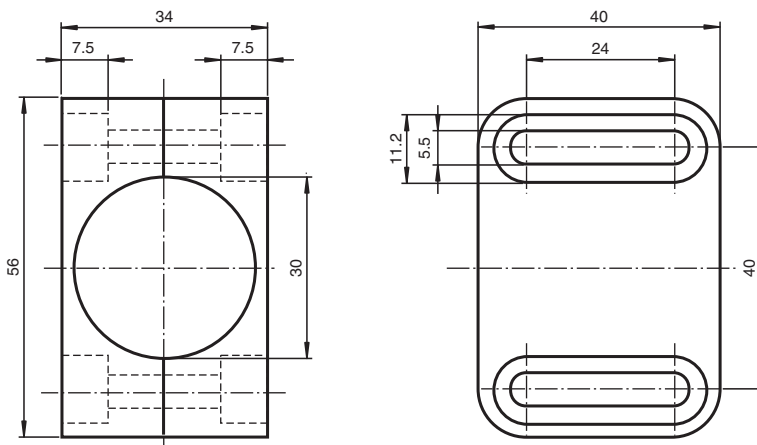

Technical Data

General specifications

Inside diameter 30 mm

Ambient conditions

Ambient temperature -25 ... 85 °C (-13 ... 185 °F)

Mechanical specifications

Material Base: Crastin/PBT (green)
Upper section: PA (transparent)

Tightening torque, fastening screws max. 1.2 Nm

Dimensions 40 mm x 56 mm x 36 mm

Release date: 2022-01-12 Date of issue: 2022-01-12 Filename: 000051_eng.pdf

Refer to "General Notes Relating to Pepperl+Fuchs Product Information".

Pepperl+Fuchs Group
www.pepperl-fuchs.com

USA: +1 330 486 0001
fa-info@us.pepperl-fuchs.com

Germany: +49 621 776 1111
fa-info@de.pepperl-fuchs.com

Singapore: +65 6779 9091
fa-info@sg.pepperl-fuchs.com

PF PEPPERL+FUCHS