

# General purpose relays 7 - 10 A



Automation for  
blinds, grilles  
and shutters



Control and  
management of  
electric power



Shipyards



Road / tunnel  
lighting



Hoists and  
cranes



Circuit breakers  
and switches



Control panels



Panels for electrical  
distribution

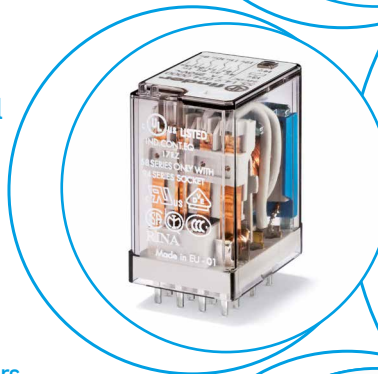



**General purpose relays  
For printed circuit mounting**

**Type 55.12**

- 2 CO 10 A

**Type 55.13**

- 3 CO 10 A

**Type 55.14**

- 4 CO 7 A

- AC & DC coils
- Cadmium Free contacts
- Contact material options
- RT III (wash tight) option available

**55.12**



- 2 CO 10 A
- PCB mount

**55.13**



- 3 CO 10 A
- PCB mount

**55.14**



- 4 CO 7 A
- PCB mount

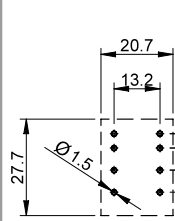
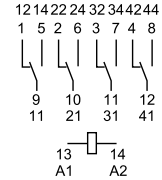
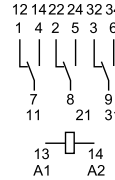
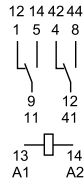

Copper side view

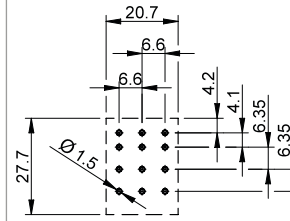

Copper side view

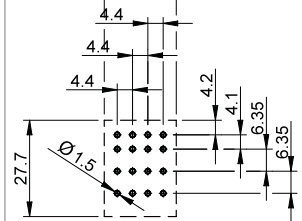

Copper side view

FOR UL RATINGS SEE:  
"General technical information" page 7

For outline drawing see page 7

**Contact specification**

|   |           |             |             |             |
|---|-----------|-------------|-------------|-------------|
| Contact configuration                       |           | 2 CO (DPDT) | 3 CO (3PDT) | 4 CO (4PDT) |
| Rated current/Maximum peak current          | A         | 10/20       | 10/20       | 7/15        |
| Rated voltage/<br>Maximum switching voltage | V AC      | 250/400     | 250/400     | 250/250     |
| Rated load AC1                              | VA        | 2500        | 2500        | 1750        |
| Rated load AC15 (230 V AC)                  | VA        | 500         | 500         | 350         |
| Single phase motor rating (230 V AC)        | kW        | 0.37        | 0.37        | 0.125       |
| Breaking capacity DC1: 24/110/220 V         | A         | 10/0.5/0.25 | 10/0.5/0.25 | 7/0.5/0.25  |
| Minimum switching load                      | mW (V/mA) | 300 (5/5)   | 300 (5/5)   | 300 (5/5)   |
| Standard contact material                   |           | AgNi        | AgNi        | AgNi        |

**Coil specification**

|                                   |                 |   |       |       |
|-----------------------------------|-----------------|---|-------|-------|
| Nominal voltage (U <sub>N</sub> ) | V AC (50/60 Hz) | 6 - 12 - 24 - 48 - 60 - 110 - 120 - 230 - 240 |       |       |
|                                   | V DC            | 6 - 12 - 24 - 48 - 60 - 110 - 125 - 220       |       |       |
| Rated power AC/DC                 | VA (50 Hz)/W    | 1.5/1   | 1.5/1 | 1.5/1 |
| Operating range                   | AC              | (0.8...1.1)U <sub>N</sub>                     |       |       |
|                                   | DC              | (0.8...1.1)U <sub>N</sub>                     |       |       |
| Holding voltage                   | AC/DC           | 0.8 U <sub>N</sub> / 0.5 U <sub>N</sub>       |       |       |
| Must drop-out voltage             | AC/DC           | 0.2 U <sub>N</sub> / 0.1 U <sub>N</sub>       |       |       |

**Technical data**

|   |        |   |   |   |
|---|--------|---|---|---|
| Mechanical life AC/DC                               | cycles | 20 · 10 <sup>6</sup> / 50 · 10 <sup>6</sup> | 20 · 10 <sup>6</sup> / 50 · 10 <sup>6</sup> | 20 · 10 <sup>6</sup> / 50 · 10 <sup>6</sup> |
| Electrical life at rated load AC1                   | cycles | 200 · 10 <sup>3</sup>                       | 200 · 10 <sup>3</sup>                       | 150 · 10 <sup>3</sup>                       |
| Operate/release time                                | ms     | 10/5  | 9/5   | 9/5   |
| Insulation between coil<br>and contacts (1.2/50 μs) | kV     | 4   | 4   | 4   |
| Dielectric strength<br>between open contacts        | V AC   | 1000  | 1000  | 1000  |
| Ambient temperature range                           | °C     | -40...+85                                   | -40...+85                                   | -40...+85                                   |
| Environmental protection                            |        | RT I  | RT I  | RT I  |

**Approvals** (according to type)





## Ordering information

Example: 55 series plug-in relay, 4 CO, 12 V DC coil, lockable test button and mechanical indicator.

**A**   **B**   **C**   **D**

5 5 . 3   4 . 9 . 0 1 2 . 0 0   4 0

**Series** —————

**Type**  
1 = PCB  
3 = Plug-in

**No. of poles**  
2 = 2 pole, 10 A  
3 = 3 pole, 10 A  
4 = 4 pole, 7 A

**Coil version**  
8 = AC (50/60 Hz)  
9 = DC

**Coil voltage**  
See coil specifications

**A: Contact material**  
0 = Standard AgNi  
5 = AgNi + Au

**B: Contact circuit**  
0 = CO (nPDT)

**D: Special versions**  
0 = Standard  
1 = Wash tight (RT III)  
for 55.12, 55.13 and 55.14 only

**C: Options**  
0 = None  
1 = Lockable test button  
2 = Mechanical indicator  
3 = LED (AC)  
4 = Lockable test button + mechanical indicator  
5 = Lockable test button + LED (AC)  
54 = Lockable test button + LED (AC) + mechanical indicator  
6\* = Double LED (DC non-polarized)  
7\* = Lockable test button + double LED (DC non-polarized)  
74\* = Lockable test button + double LED (DC non-polarized) + mechanical indicator  
8\* = LED + diode (DC, polarity positive to pin A1/13)  
9\* = Lockable test button + LED + diode (DC, polarity positive to pin A1/13)  
94\* = Lockable test button + LED + diode (DC, polarity positive to pin A1/13) + mechanical indicator  
\* Options not available for 220 V DC versions.

### Selecting features and options: only combinations in the same row are possible.

Preferred selections for best availability are shown in **bold**.

| Type        | Coil version | A            | B        | C                            | D            |
|-------------|--------------|--------------|----------|------------------------------|--------------|
| 55.32/34    | AC - DC      | 0 - 5        | 0        | 0                            | 0            |
|             | AC           | <b>0</b> - 5 | <b>0</b> | 2 - 3 - <b>4</b> - 5         | <b>0</b>     |
|             | AC           | 0 - 5        | 0        | 54                           | /            |
|             | DC           | <b>0</b> - 5 | <b>0</b> | 2 - <b>4</b> - 6 - 7 - 8 - 9 | <b>0</b>     |
|             | DC           | 0 - 5        | 0        | 74 - 94                      | /            |
| 55.33       | AC - DC      | <b>0</b> - 5 | <b>0</b> | <b>0</b>                     | <b>0</b>     |
|             | AC           | 0 - 5        | 0        | 1 - 3 - 5                    | 0            |
|             | DC           | 0 - 5        | 0        | 1 - 6 - 7 - 8 - 9            | 0            |
| 55.12/13/14 | AC - DC      | <b>0</b> - 5 | <b>0</b> | <b>0</b>                     | <b>0</b> - 1 |

### Descriptions: options and special versions

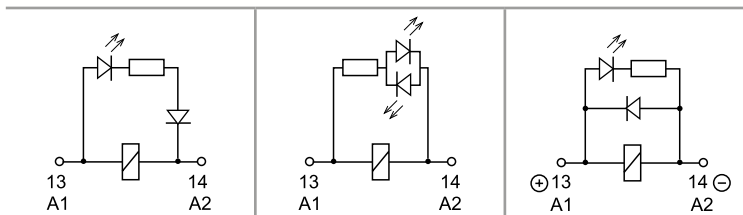

**C: Option 3, 5, 54**  
LED (AC)

**C: Option 6, 7, 74**  
Double LED  
(DC non-polarized)

**C: Option 8, 9, 94**  
LED + diode (DC, polarity positive to pin A1/13)

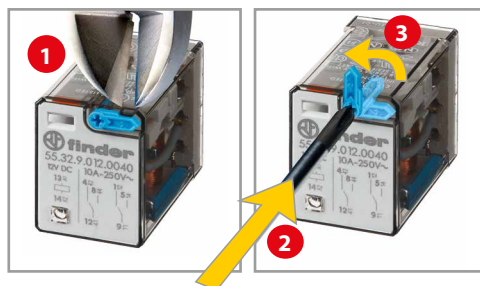

### Lockable test button and mechanical flag indicator (0010, 0040, 0050, 0054, 0070, 0074, 0090, 0094)



The dual-purpose Finder test button can be used in two ways:

Case 1) The plastic pip (located directly above the test button) remains intact. In this case, when the test button is pushed, the contacts operate. When the test button is released the contacts return to their former state.

Case 2) The plastic pip is broken-off (using an appropriate cutting tool). In this case, (in addition to the above function), when the test button is pushed and rotated, the contacts are latched in the operating state, and remain so until the test button is rotated back to its former position.

In both cases ensure that the test button actuation is swift and decisive.

### Technical data

| Insulation according to EN 61810-1  |                         | 2 pole - 3 pole                          | 4 pole                                     |
|---|-------------------------|--|--|
| Nominal voltage of supply system  | V AC                    | 230/400                                  | 230  |
| Rated insulation voltage  | V AC                    | 400                                      | 250  |
| Pollution degree  |                         | 2  | 2  |
| <b>Insulation between coil and contact set</b>                              |                         |  |  |
| Type of Insulation  |                         | Basic                                    | Basic                                      |
| Overvoltage category  |                         | III                                      | III  |
| Rated impulse voltage   | kV (1.2/50 μs)          | 4  | 4  |
| Dielectric strength   | V AC                    | 2000                                     | 2000                                       |
| <b>Insulation between adjacent contacts</b>                                 |                         |  |  |
| Type of insulation  |                         | Basic                                    | Basic                                      |
| Overvoltage category  |                         | III                                      | II   |
| Rated impulse voltage   | kV (1.2/50 μs)          | 4  | 2.5  |
| Dielectric strength   | V AC                    | 2000                                     | 2000                                       |
| <b>Insulation between open contacts</b>                                     |                         |  |  |
| Type of disconnection   |                         | Micro-disconnection                      | Micro-disconnection                        |
| Dielectric strength   | V AC/kV (1.2/50 μs)     | 1000/1.5                                 | 1000/1.5                                   |
| <b>Insulation between coil terminals</b>                                    |                         |  |  |
| Rated impulse voltage (surge) differential mode (according to EN 61000-4-5) | kV (1.2/50 μs)          | 4  |  |
| <b>Other data</b>   |                         |  |  |
| Bounce time: NO/NC  | ms                      | 1/4 (2 pole), 1/6 (3 pole), 2/4 (4 pole) |  |
| Vibration resistance (5...55)Hz: NO/NC                                      | g                       | 15/15                                    |  |
| Shock resistance  | g                       | 16                                       |  |
| Power lost to the environment   | without contact current | W  | 1  |
|   | with rated current      | W  | 3 (2 pole)      4 (3 pole)      3 (4 pole) |
| Recommended distance between relays mounted on PCB                          | mm                      | ≥ 5                                      |  |

### Contact specification

**F 55 - Electrical life (AC) v contact current**  
2 and 3 pole relays

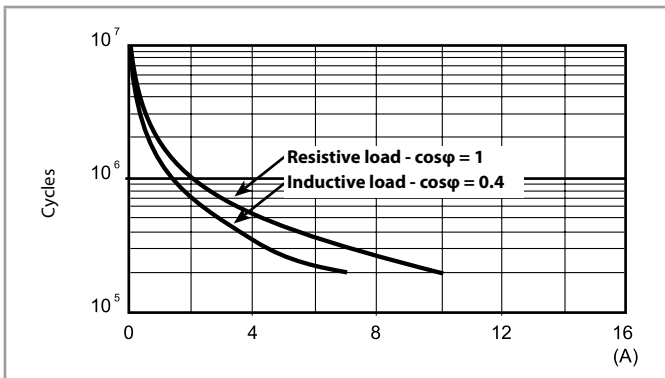

**F 55 - Electrical life (AC) v contact current**  
4 pole relays

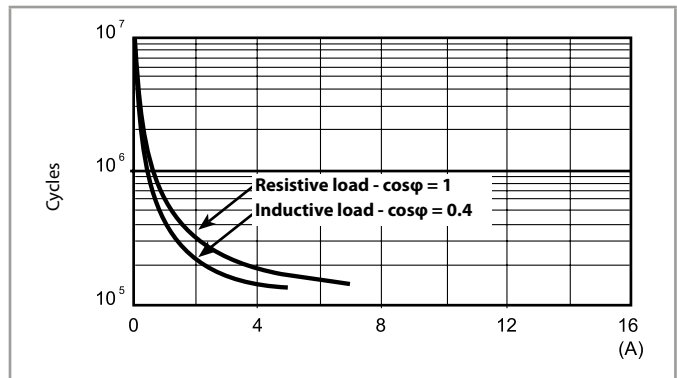

**H 55 - Maximum DC1 breaking capacity**

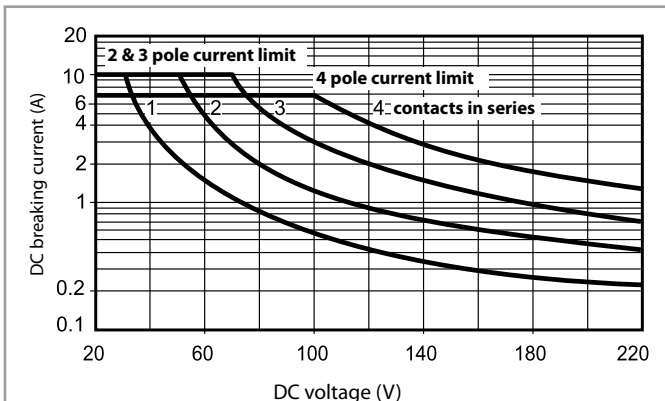

- When switching a resistive load (DC1) having voltage and current values under the curve, an electrical life of  $\geq 100 \cdot 10^3$  can be expected.
- In the case of DC13 loads, the connection of a diode in parallel with the load will permit a similar electrical life as for a DC1 load.  
Note: the release time of the load will be increased.

## Coil specifications

### DC coil data

| Nominal voltage<br>$U_N$<br>V | Coil code | Operating range |                | Resistance<br>R<br>$\Omega$ | Rated coil consumption<br>I at $U_N$<br>mA |
|-------------------------------|-----------|-----------------|----------------|-----------------------------|--|
|                               |           | $U_{min}$<br>V  | $U_{max}$<br>V |                             |  |
| 6                             | 9.006     | 4.8             | 6.6            | 40                          | 150  |
| 12                            | 9.012     | 9.6             | 13.2           | 140                         | 86   |
| 24                            | 9.024     | 19.2            | 26.4           | 600                         | 40   |
| 48                            | 9.048     | 38.4            | 52.8           | 2400                        | 20   |
| 60                            | 9.060     | 48              | 66             | 4000                        | 15   |
| 110                           | 9.110     | 88              | 121            | 12500                       | 8.8  |
| 125                           | 9.125     | 100             | 138            | 17300                       | 7.2  |
| 220                           | 9.220     | 176             | 242            | 54000                       | 4  |

### AC coil data

| Nominal voltage<br>$U_N$<br>V | Coil code | Operating range |                | Resistance<br>R<br>$\Omega$ | Rated coil consumption<br>I at $U_N$<br>mA |
|-------------------------------|-----------|-----------------|----------------|-----------------------------|--|
|                               |           | $U_{min}$<br>V  | $U_{max}$<br>V |                             |  |
| 6                             | 8.006     | 4.8             | 6.6            | 12                          | 200  |
| 12                            | 8.012     | 9.6             | 13.2           | 50                          | 97   |
| 24                            | 8.024     | 19.2            | 26.4           | 190                         | 53   |
| 48                            | 8.048     | 38.4            | 52.8           | 770                         | 25   |
| 60                            | 8.060     | 48              | 66             | 1200                        | 21   |
| 110                           | 8.110     | 88              | 121            | 3940                        | 12.5                                       |
| 120                           | 8.120     | 96              | 132            | 4700                        | 12   |
| 230                           | 8.230     | 184             | 253            | 17000                       | 6  |
| 240                           | 8.240     | 192             | 264            | 19100                       | 5.3  |

### R 55 - DC coil operating range v ambient temperature

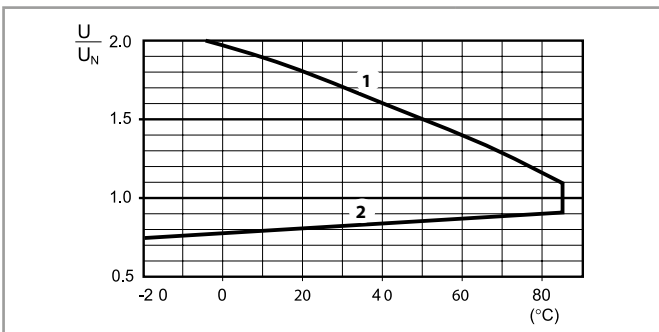

- 1 - Max. permitted coil voltage.  
2 - Min. pick-up voltage with coil at ambient temperature.

### R 55 - AC coil operating range v ambient temperature

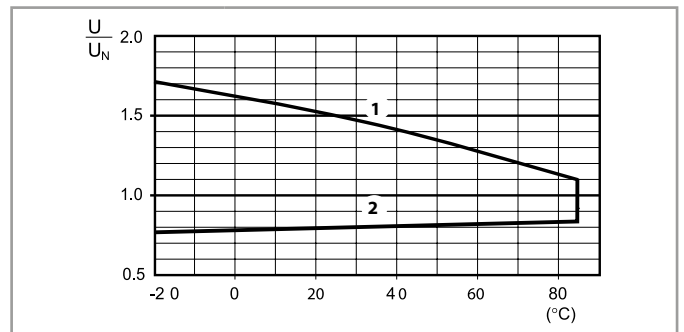

- 1 - Max. permitted coil voltage.  
2 - Min. pick-up voltage with coil at ambient temperature.

## Outline drawings

Type 55.12

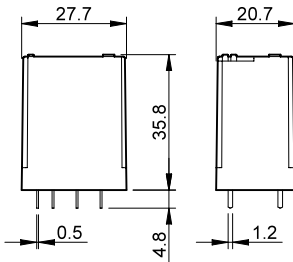

Type 55.13

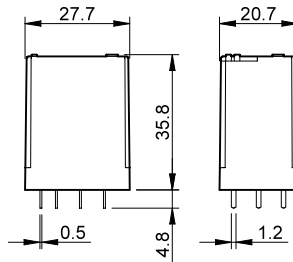

Type 55.14

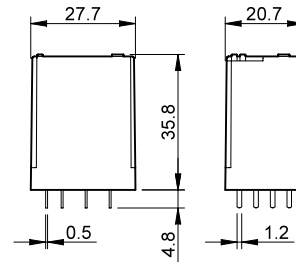

Type 55.32

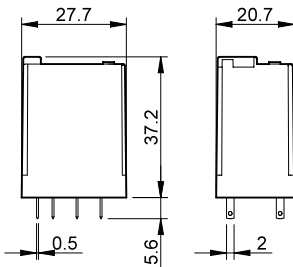

Type 55.33

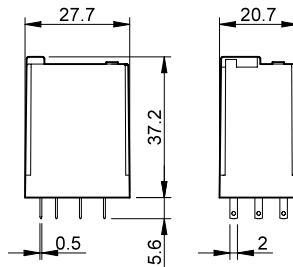

Type 55.34

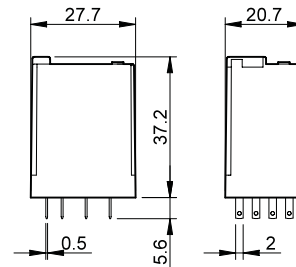

Accessories

A



056.25



056.25 with relay

Top flange mount adaptor for 55.32, 55.33, 55.34

056.25

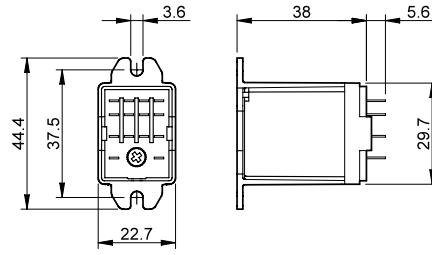

056.25 with relay



056.26



056.26 with relay

Rear flange mount adaptor for 55.32, 55.33, 55.34

056.26

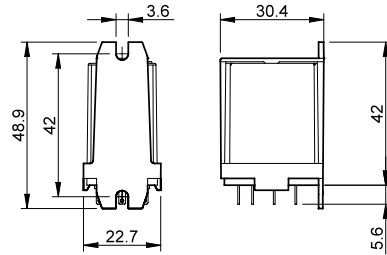

056.26 with relay



056.27



056.27 with relay

Top 35 mm rail (EN 60715) adaptor for 55.32, 55.33, 55.34

056.27

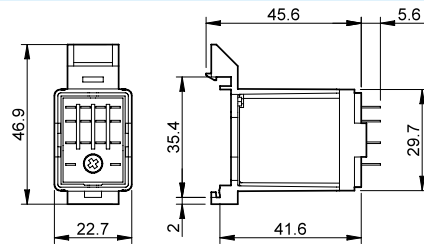

056.27 with relay



A

94.P4

See page 10



| Module | Socket | Relay | Description   | Mounting                                | Accessories   |
|--------|--------|-------|---|---|---|
| 99.02  | 94.P3  | 55.33 | <b>Push-in terminal socket</b><br>- For fast cable connections<br>- Top terminals - Contacts<br>- Bottom terminals - Coil | Panel or 35 mm rail<br>(EN 60715) mount | - Coil indication and EMC suppression modules<br>- Jumper link<br>- Timer modules<br>- Plastic retaining and release clip |
|        | 94.P4  | 55.32 |   |   |   |
|        |        | 55.34 |   |   |   |

94.04

See page 12



| Module | Socket | Relay | Description   | Mounting                                | Accessories   |
|--------|--------|-------|---|---|---|
| 99.02  | 94.02  | 55.32 | <b>Screw terminal (Box clamp) socket</b><br>- Top terminals - Contacts<br>- Bottom terminals - Coil | Panel or 35 mm rail<br>(EN 60715) mount | - Coil indication and EMC suppression modules<br>- Jumper link<br>- Timer modules<br>- Plastic retaining and release clip |
|        | 94.03  | 55.33 |   |   |   |
|        | 94.04  | 55.32 |   |   |   |

94.54

See page 13



| Module | Socket | Relay | Description   | Mounting                                | Accessories   |
|--------|--------|-------|---|---|---|
| 99.02  | 94.54  | 55.32 | <b>Screwless terminal socket</b><br>- Top terminals - Contacts<br>- Bottom terminals - Coil | Panel or 35 mm rail<br>(EN 60715) mount | - Coil indication and EMC suppression modules<br>- Jumper link<br>- Timer modules<br>- Plastic retaining and release clip |
|        |        | 55.34 |   |   |   |

94.84.2

See page 14



| Module | Socket  | Relay | Description                              | Mounting                                | Accessories  |
|--------|---------|-------|--|---|--|
| 99.80  | 94.84.2 | 55.32 | <b>Screw terminal (Box clamp) socket</b> | Panel or 35 mm rail<br>(EN 60715) mount | - Coil indication and EMC suppression modules<br>- Jumper link<br>- Plastic retaining and release clip |
|        |         | 55.34 |  |   |  |

94.94.3

See page 15



| Module | Socket  | Relay | Description   | Mounting                                | Accessories  |
|--------|---------|-------|---|---|--|
| 99.80  | 94.94.3 | 55.32 | <b>Screw terminal (Box clamp) socket</b><br>- Top terminals - Contacts<br>- Bottom terminals - Coil | Panel or 35 mm rail<br>(EN 60715) mount | - Coil indication and EMC suppression modules<br>- Jumper link<br>- Plastic retaining and release clip |
|        |         | 55.32 |   |   |  |
|        |         | 55.34 |   |   |  |

94.74

See page 16



| Module | Socket | Relay | Description   | Mounting                                | Accessories   |
|--------|--------|-------|---|---|---|
| 99.01  | 94.72  | 55.32 | <b>Screw terminal (Plate clamp) socket</b><br>For 94.82:<br>- 23 mm wide for space saving | Panel or 35 mm rail<br>(EN 60715) mount | - Coil indication and EMC suppression modules<br>- Plastic retaining and release clip |
|        |        | 55.33 |   |   |   |
|        |        | 55.32 |   |   |   |
|        |        | 55.34 |   |   |   |

94.14

See page 17



| Module | Socket | Relay | Description       | Mounting     | Accessories            |
|--------|--------|-------|-------------------|--------------|------------------------|
| —      | 94.12  | 55.32 | <b>PCB socket</b> | PCB mounting | - Metal retaining clip |
| —      | 94.13  | 55.33 |                   |              |                        |
| —      | 94.14  | 55.32 |                   |              |                        |

94.22

See page 17



| Module | Socket | Relay | Description                                | Mounting                           | Accessories            |
|--------|--------|-------|--|------------------------------------|------------------------|
| —      | 94.22  | 55.32 | <b>Panel mount with solder connections</b> | Panel mount on<br>1 mm thick panel | - Metal retaining clip |
| —      | 94.23  | 55.33 |  |                                    |                        |
| —      | 94.24  | 55.32 |  |                                    |                        |

94.34

See page 18



| Module | Socket | Relay | Description                                | Mounting        | Accessories            |
|--------|--------|-------|--|-----------------|------------------------|
| —      | 94.32  | 55.32 | <b>Panel mount with solder connections</b> | M3 screw fixing | - Metal retaining clip |
| —      | 94.33  | 55.33 |  |                 |                        |
| —      | 94.34  | 55.32 |  |                 |                        |

A



94.P4

Approvals  
(according to type):



Certain relay/socket combinations



094.91.3

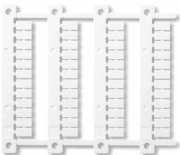

060.48

|  |                                   |                             |
|--|-----------------------------------|-----------------------------|
| <b>Push-in terminal socket</b> panel or 35 mm (EN 60715) rail mount  | <b>94.P3</b><br><b>Blue</b>       | <b>94.P4</b><br><b>Blue</b> |
| For relay type   | 55.33                             | 55.32, 55.34                |
| <b>Accessories</b>   |                                   |                             |
| Metal retaining clip   |                                   | 094.71                      |
| Plastic retaining and release clip (supplied with socket - packaging code SPA)   |                                   | 094.91.3                    |
| 6-way jumper link  |                                   | 094.56                      |
| Identification tag   |                                   | 095.00.4                    |
| 2-way jumper link  |                                   | 094.52.1                    |
| 2-way jumper link  |                                   | 097.52                      |
| Marker tag holder  |                                   | 097.00                      |
| Modules (see table below)  |                                   | 99.02                       |
| Timer modules (see table below)  |                                   | 86.30                       |
| Sheet of marker tags for plastic retaining and release clip 094.91.3 and for marker tag holder 097.00, 48 tags, 6 x 12 mm for CEMBRE thermal transfer printers |                                   | 060.48                      |
| <b>Technical data</b>  |                                   |                             |
| Rated values   | 10 A - 250 V                      |                             |
| Dielectric strength  | 2 kV AC                           |                             |
| Protection category  | IP 20                             |                             |
| Ambient temperature  | °C -40...+70                      |                             |
| Wire strip length  | mm 10                             |                             |
| Min. wire size for 94.P3 and 94.P4 sockets   | solid wire                        | stranded wire               |
|  | mm <sup>2</sup> 0.5               | 0.5                         |
|  | AWG 21                            | 21                          |
| Max. wire size for 94.P3 and 94.P4 sockets   | solid wire                        | stranded wire               |
|  | mm <sup>2</sup> 2 x 1.5 / 1 x 2.5 | 2 x 1.5 / 1 x 2.5           |
|  | AWG 2 x 16 / 1 x 14               | 2 x 16 / 1 x 14             |

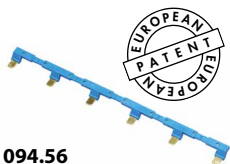
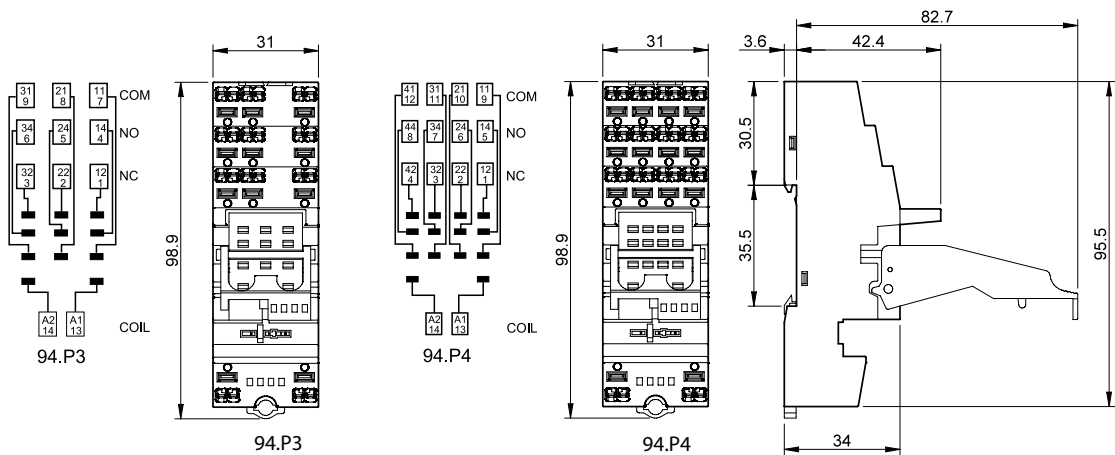

094.56

|  |               |
|--|---------------|
| <b>6-way jumper link</b> for 94.P3 and 94.P4 sockets | 094.56 (blue) |
| Rated values   | 10 A - 250 V  |

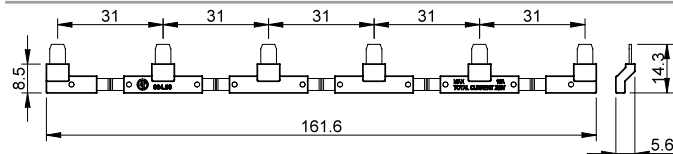

094.52.1

|  |              |
|--|--------------|
| <b>2-way jumper link</b> for 94.P3 and 94.P4 sockets | 094.52.1     |
| Rated values   | 10 A - 250 V |

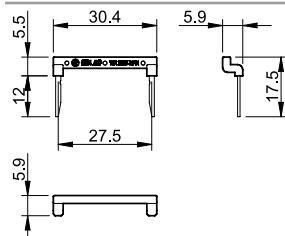



097.52

|  |              |
|--|--------------|
| <b>2-way jumper link</b> for 94.P3 and 94.P4 sockets | 097.52       |
| Rated values   | 10 A - 250 V |

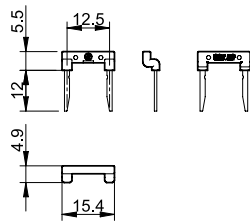

097.00

|  |        |
|--|--------|
| <b>Marker tag holder</b> for 94.P3 and 94.P4 sockets | 097.00 |
|--|--------|

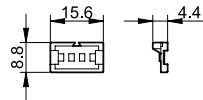

86.30

|   |                  |
|---|------------------|
| <b>86 series timer modules</b>                          |                  |
| (12...24)V AC/DC; Bi-function: AI, DI; (0.05 s...100 h) | 86.30.0.024.0000 |
| (110...125)V AC; Bi-function: AI, DI; (0.05 s...100 h)  | 86.30.8.120.0000 |
| (230...240)V AC; Bi-function: AI, DI; (0.05 s...100 h)  | 86.30.8.240.0000 |

Approvals (according to type):



99.02

Approvals  
(according to type):



DC Modules with  
non-standard polarity  
(+A2) on request.

|  |                    |                |
|--|--------------------|----------------|
| <b>99.02 coil indication and EMC suppression modules</b> for 94.P3 and 94.P4 sockets |                    |                |
| Diode (+A1, standard polarity)   | (6...220)V DC      | 99.02.3.000.00 |
| LED  | (6...24)V DC/AC    | 99.02.0.024.59 |
| LED  | (28...60)V DC/AC   | 99.02.0.060.59 |
| LED  | (110...240)V DC/AC | 99.02.0.230.59 |
| LED + Diode (+A1, standard polarity)   | (6...24)V DC       | 99.02.9.024.99 |
| LED + Diode (+A1, standard polarity)   | (28...60)V DC      | 99.02.9.060.99 |
| LED + Diode (+A1, standard polarity)   | (110...220)V DC    | 99.02.9.220.99 |
| LED + Varistor   | (6...24)V DC/AC    | 99.02.0.024.98 |
| LED + Varistor   | (28...60)V DC/AC   | 99.02.0.060.98 |
| LED + Varistor   | (110...240)V DC/AC | 99.02.0.230.98 |
| RC circuit   | (6...24)V DC/AC    | 99.02.0.024.09 |
| RC circuit   | (28...60)V DC/AC   | 99.02.0.060.09 |
| RC circuit   | (110...240)V DC/AC | 99.02.0.230.09 |
| Residual current by-pass*  | (110...240)V AC    | 99.02.8.230.07 |

\*Additional 0.9 W power dissipation

A



94.04

Approvals  
(according to type):



Certain relay/socket combinations



94.91.3

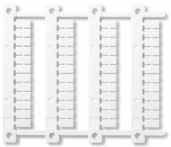

060.48

| Screw terminal (Box clamp) socket panel or 35 mm (EN 60715) rail mount   | 94.02 Blue                      | 94.02.0 Black | 94.03 Blue | 94.03.0 Black   | 94.04 Blue   | 94.04.0 Black |
|--|---------------------------------|---------------|------------|-----------------|--------------|---------------|
| For relay type   | 55.32                           |               | 55.33      |                 | 55.32, 55.34 |               |
| <b>Accessories</b>   |                                 |               |            |                 |              |               |
| Metal retaining clip   | 094.71                          |               |            |                 |              |               |
| Plastic retaining and release clip (supplied with socket - packaging code SPA)   | 094.91.3                        | 094.91.30     | 094.91.3   | 094.91.30       | 094.91.3     | 094.91.30     |
| 6-way jumper link  | 094.06                          | 094.06.0      | 094.06     | 094.06.0        | 094.06       | 094.06.0      |
| Identification tag   | 094.00.4                        |               |            |                 |              |               |
| Marker tag holder  | 097.00                          |               |            |                 |              |               |
| Modules (see table below)  | 99.02                           |               |            |                 |              |               |
| Timer modules (see table below)  | 86.30                           |               |            |                 |              |               |
| Sheet of marker tags for plastic retaining and release clip 094.91.3 and for marker tag holder 097.00, 48 tags, 6 x 12 mm for CEMBRE thermal transfer printers | 060.48                          |               |            |                 |              |               |
| <b>Technical data</b>  |                                 |               |            |                 |              |               |
| Rated values   | 10 A - 250 V                    |               |            |                 |              |               |
| Dielectric strength  | 2 kV AC                         |               |            |                 |              |               |
| Protection category  | IP 20                           |               |            |                 |              |               |
| Ambient temperature  | °C -40...+70                    |               |            |                 |              |               |
| Screw torque   | Nm 0.5                          |               |            |                 |              |               |
| Wire strip length  | mm 8                            |               |            |                 |              |               |
| Max. wire size for 94.02/03/04 sockets   | solid wire                      |               |            | stranded wire   |              |               |
|  | mm <sup>2</sup> 1 x 6 / 2 x 2.5 |               |            | 1 x 4 / 2 x 2.5 |              |               |
| AWG  | 1 x 10 / 2 x 14                 |               |            | 1 x 12 / 2 x 14 |              |               |

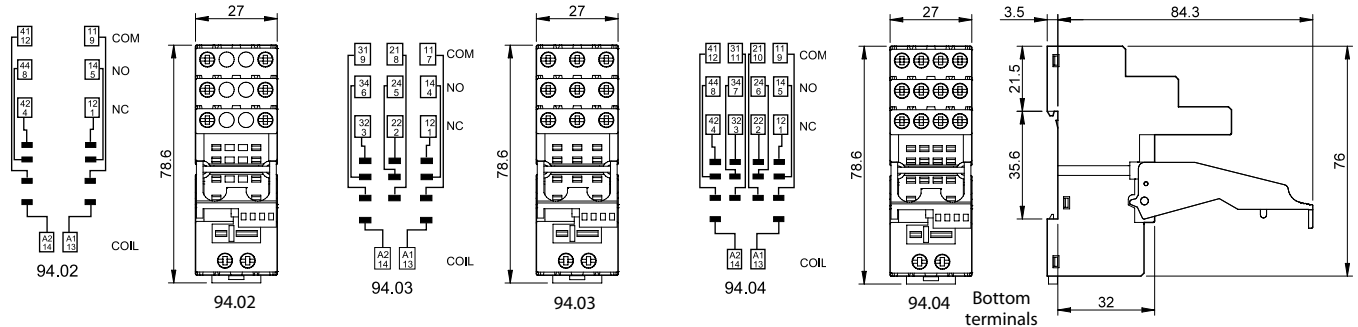

94.06

| 6-way jumper link for 94.02, 94.03 and 94.04 sockets | 94.06 (blue) | 94.06.0 (black) |
|--|--------------|-----------------|
| Rated values   | 10 A - 250 V |                 |

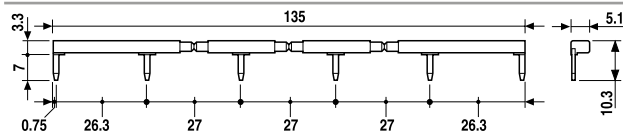

86.30

| 86 series timer modules                                 |                  |
|---|------------------|
| (12...24)V AC/DC; Bi-function: AI, DI; (0.05 s...100 h) | 86.30.0.024.0000 |
| (110...125)V AC; Bi-function: AI, DI; (0.05 s...100 h)  | 86.30.8.120.0000 |
| (230...240)V AC; Bi-function: AI, DI; (0.05 s...100 h)  | 86.30.8.240.0000 |

Approvals (according to type):



99.02

Approvals  
(according to type):



DC Modules with non-standard polarity (+A2) on request.

| 99.02 coil indication and EMC suppression modules for 94.02, 94.03 and 94.04 sockets |                    |                |
|--|--------------------|----------------|
| Diode (+A1, standard polarity)   | (6...220)V DC      | 99.02.3.000.00 |
| LED  | (6...24)V DC/AC    | 99.02.0.024.59 |
| LED  | (28...60)V DC/AC   | 99.02.0.060.59 |
| LED  | (110...240)V DC/AC | 99.02.0.230.59 |
| LED + Diode (+A1, standard polarity)   | (6...24)V DC       | 99.02.9.024.99 |
| LED + Diode (+A1, standard polarity)   | (28...60)V DC      | 99.02.9.060.99 |
| LED + Diode (+A1, standard polarity)   | (110...220)V DC    | 99.02.9.220.99 |
| LED + Varistor   | (6...24)V DC/AC    | 99.02.0.024.98 |
| LED + Varistor   | (28...60)V DC/AC   | 99.02.0.060.98 |
| LED + Varistor   | (110...240)V DC/AC | 99.02.0.230.98 |
| RC circuit   | (6...24)V DC/AC    | 99.02.0.024.09 |
| RC circuit   | (28...60)V DC/AC   | 99.02.0.060.09 |
| RC circuit   | (110...240)V DC/AC | 99.02.0.230.09 |
| Residual current by-pass*  | (110...240)V AC    | 99.02.8.230.07 |

\*Additional 0.9 W power dissipation

A

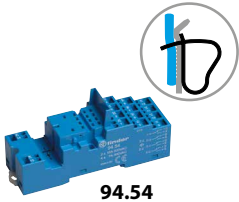

94.54

Approvals  
(according to type):



094.91.3

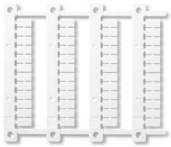

060.48

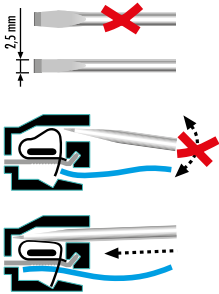

|  |                                 |                     |
|--|---------------------------------|---------------------|
| <b>Screwless terminal socket 35 mm rail (EN 60715) mount</b>   |                                 | <b>94.54 (blue)</b> |
| For relay type   |                                 | 55.32, 55.34        |
| <b>Accessories</b>   |                                 |                     |
| Metal retaining clip   |                                 | 094.71              |
| Plastic retaining and release clip   |                                 | 094.91.3            |
| 6-way jumper link  |                                 | 094.56              |
| Modules (see table below)  |                                 | 99.02, 86.30        |
| Sheet of marker tags for retaining and release clip 094.91.3, plastic, 48 tags, 6 x 12 mm for CEMBRE thermal transfer printers |                                 | 060.48              |
| <b>Technical data</b>  |                                 |                     |
| Rated values   |                                 | 10 A - 250 V        |
| Dielectric strength  |                                 | 2 kV AC             |
| Protection category  |                                 | IP 20               |
| Ambient temperature  |                                 | °C -25...+70        |
| Wire strip length  |                                 | mm 10               |
| Max. wire size for 94.54 sockets   |                                 | solid wire          |
|  |                                 | stranded wire       |
|  |                                 |                     |
|  | mm <sup>2</sup> 2 x (0.5...1.5) | 2 x (0.5...1.5)     |
|  | AWG 2 x (21...14)               | 2 x (21...14)       |

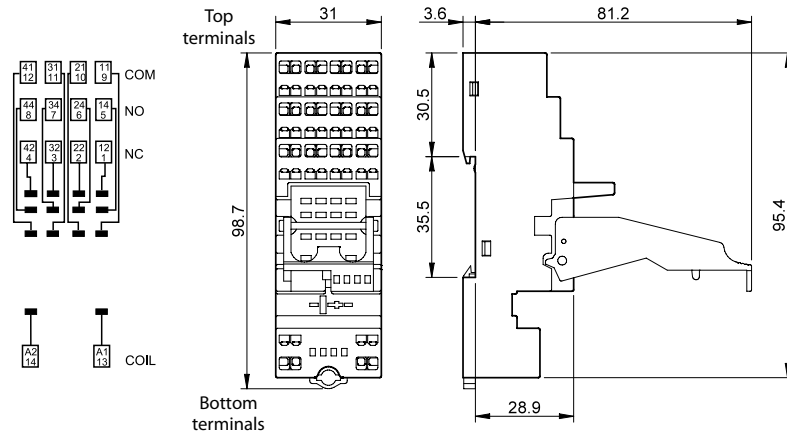

Sockets + jumper link

|                          |               |
|--------------------------|---------------|
| <b>6-way jumper link</b> | 094.56 (blue) |
| Rated values             | 10 A - 250 V  |

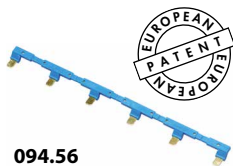
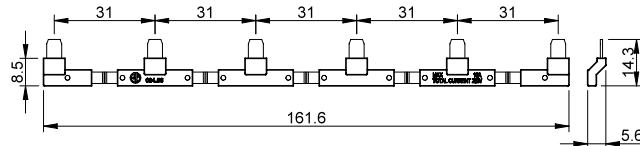

094.56

|   |                  |
|---|------------------|
| <b>86 series timer modules</b>                          |                  |
| (12...24)V AC/DC; Bi-function: AI, DI; (0.05 s...100 h) | 86.30.0.024.0000 |
| (110...125)V AC; Bi-function: AI, DI; (0.05 s...100 h)  | 86.30.8.120.0000 |
| (230...240)V AC; Bi-function: AI, DI; (0.05 s...100 h)  | 86.30.8.240.0000 |



86.30

Approvals (according to type):

|  |                    |                |
|--|--------------------|----------------|
| <b>99.02 coil indication and EMC suppression modules for 94.54 sockets</b> |                    |                |
| Diode (+A1, standard polarity)   | (6...220)V DC      | 99.02.3.000.00 |
| LED  | (6...24)V DC/AC    | 99.02.0.024.59 |
| LED  | (28...60)V DC/AC   | 99.02.0.060.59 |
| LED  | (110...240)V DC/AC | 99.02.0.230.59 |
| LED + Diode (+A1, standard polarity)                                       | (6...24)V DC       | 99.02.9.024.99 |
| LED + Diode (+A1, standard polarity)                                       | (28...60)V DC      | 99.02.9.060.99 |
| LED + Diode (+A1, standard polarity)                                       | (110...220)V DC    | 99.02.9.220.99 |
| LED + Varistor   | (6...24)V DC/AC    | 99.02.0.024.98 |
| LED + Varistor   | (28...60)V DC/AC   | 99.02.0.060.98 |
| LED + Varistor   | (110...240)V DC/AC | 99.02.0.230.98 |
| RC circuit   | (6...24)V DC/AC    | 99.02.0.024.09 |
| RC circuit   | (28...60)V DC/AC   | 99.02.0.060.09 |
| RC circuit   | (110...240)V DC/AC | 99.02.0.230.09 |
| Residual current by-pass*  | (110...240)V AC    | 99.02.8.230.07 |



99.02

Approvals  
(according to type):



DC Modules with non-standard polarity (+A2) on request.

\*Additional 0.9 W power dissipation

A



94.84.2

Approvals  
(according to type):



094.91.3

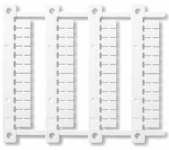

060.48

|   |                 |                 |
|---|-----------------|-----------------|
| <b>Screw terminal (Box clamp) socket panel or 35 mm (EN 60715) rail mount</b>   | <b>94.84.2</b>  | <b>94.84.20</b> |
| For relay type  | 55.32, 55.34    |                 |
| <b>Accessories</b>  |                 |                 |
| Metal retaining clip<br>(supplied with socket - packaging code SMA)   |                 | 094.71          |
| Plastic retaining and release clip  | 094.91.3        | 094.91.30       |
| 6-way jumper link   | 094.06          | 094.06.0        |
| Identification tag  |                 | 094.80.3        |
| Modules (see table below)   |                 | 99.80           |
| Sheet of marker tags for retaining and release clip 094.91.3, plastic, 48 tags,<br>6 x 12 mm for CEMBRE thermal transfer printers |                 | 060.48          |
| <b>Technical data</b>   |                 |                 |
| Rated values  | 10 A - 250 V    |                 |
| Dielectric strength   | 2 kV AC         |                 |
| Protection category   | IP 20           |                 |
| Ambient temperature   | °C -40...+70    |                 |
| Screw torque  | Nm              | 0.5             |
| Wire strip length   | mm 7            |                 |
| Max. wire size for 94.84.2 socket   | solid wire      | stranded wire   |
|   | mm <sup>2</sup> | 1 x 6 / 2 x 2.5 |
|   | AWG             | 1 x 10 / 2 x 14 |

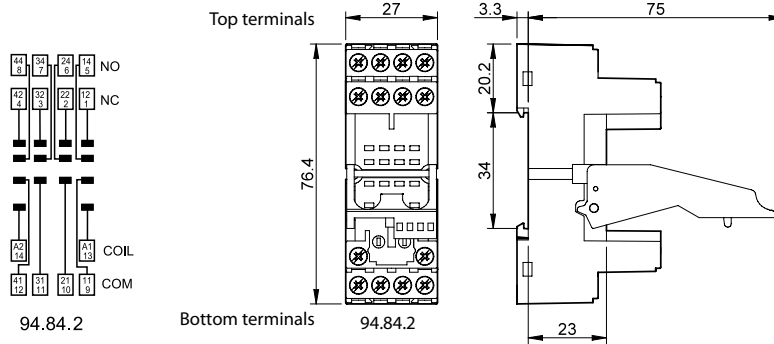

094.06



|   |               |                  |
|---|---------------|------------------|
| <b>6-way jumper link for 94.84.2 socket</b> | 094.06 (blue) | 094.06.0 (black) |
| Rated values                                | 10 A - 250 V  |                  |

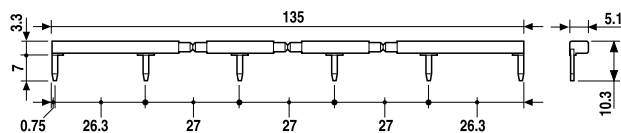

99.80

Approvals  
(according to type):



\* Modules in Black housing are available on request.

Green LED is standard.  
Red LED available on request.

|   |                    |                |
|---|--------------------|----------------|
| <b>99.80 coil indication and EMC suppression modules for 94.84.2 socket</b> |                    | <b>Blue*</b>   |
| Diode (+A1, standard polarity)  | (6...220)V DC      | 99.80.3.000.00 |
| LED   | (6...24)V DC/AC    | 99.80.0.024.59 |
| LED   | (28...60)V DC/AC   | 99.80.0.060.59 |
| LED   | (110...240)V DC/AC | 99.80.0.230.59 |
| LED + Diode (+A1, standard polarity)  | (6...24)V DC       | 99.80.9.024.99 |
| LED + Diode (+A1, standard polarity)  | (28...60)V DC      | 99.80.9.060.99 |
| LED + Diode (+A1, standard polarity)  | (110...220)V DC    | 99.80.9.220.99 |
| LED + Varistor  | (6...24)V DC/AC    | 99.80.0.024.98 |
| LED + Varistor  | (28...60)V DC/AC   | 99.80.0.060.98 |
| LED + Varistor  | (110...240)V DC/AC | 99.80.0.230.98 |
| RC circuit  | (6...24)V DC/AC    | 99.80.0.024.09 |
| RC circuit  | (28...60)V DC/AC   | 99.80.0.060.09 |
| RC circuit  | (110...240)V DC/AC | 99.80.0.230.09 |
| Residual current by-pass*   | (110...240)V AC    | 99.80.8.230.07 |

\*Additional 0.9 W power dissipation

A



94.94.3

Approvals  
(according to type):



094.91.3

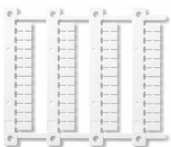

060.48

|  |                                 |                         |                       |                         |
|--|---------------------------------|-------------------------|-----------------------|-------------------------|
| <b>Screw terminal (Box clamp) socket panel or 35 mm rail mount</b>   | <b>94.92.3 (blue)</b>           | <b>94.92.30 (black)</b> | <b>94.94.3 (blue)</b> | <b>94.94.30 (black)</b> |
| For relay type   | 55.32                           |                         | 55.32, 55.34          |                         |
| <b>Accessories</b>   |                                 |                         |                       |                         |
| Metal retaining clip   | 094.71                          |                         |                       |                         |
| Plastic retaining and release clip   | 094.91.3                        | 094.91.30               | 094.91.3              | 094.91.30               |
| 6-way jumper link  | 094.06                          | 094.06.0                | 094.06                | 094.06.0                |
| Identification tag   | 094.80.3                        |                         |                       |                         |
| Modules (see table below)  | 99.80                           |                         |                       |                         |
| Sheet of marker tags for retaining and release clip 094.91.3, plastic, 48 tags, 6 x 12 mm for CEMBRE thermal transfer printers | 060.48                          |                         |                       |                         |
| <b>Technical data</b>  |                                 |                         |                       |                         |
| Rated values   | 10 A - 250 V                    |                         |                       |                         |
| Dielectric strength  | 2 kV AC                         |                         |                       |                         |
| Protection category  | IP 20                           |                         |                       |                         |
| Ambient temperature  | °C -25...+70                    |                         |                       |                         |
| Screw torque   | Nm 0.5                          |                         |                       |                         |
| Wire strip length  | mm 8                            |                         |                       |                         |
| Max. wire size for 94.92.3 and 94.94.3 sockets   | solid wire                      |                         | stranded wire         |                         |
|  | mm <sup>2</sup> 1 x 6 / 2 x 2.5 |                         | 1 x 4 / 2 x 2.5       |                         |
|  | AWG 1 x 10 / 2 x 14             |                         | 1 x 12 / 2 x 14       |                         |

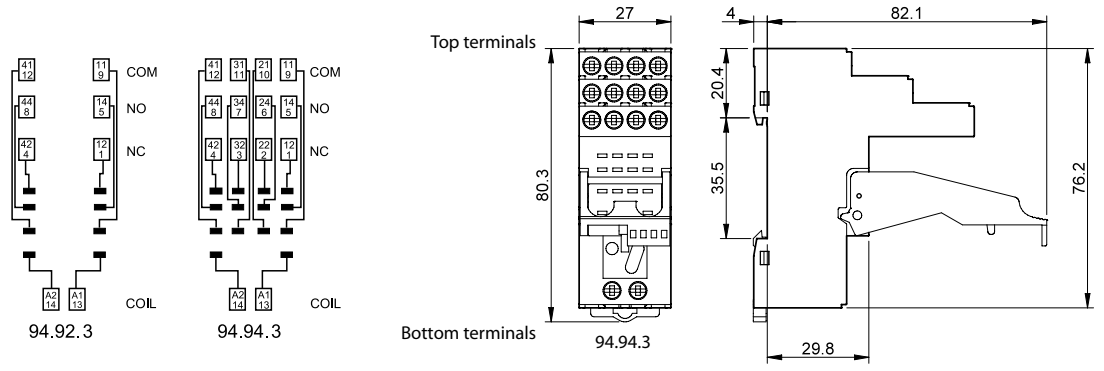

094.06



|  |                      |                         |
|--|----------------------|-------------------------|
| <b>6-way jumper link for 94.92.3 and 94.94.3 sockets</b> | <b>094.06 (blue)</b> | <b>094.06.0 (black)</b> |
| Rated values   | 10 A - 250 V         |                         |

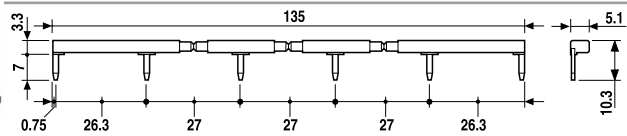

99.80

Approvals  
(according to type):



\* Modules in Black housing are available on request.

Green LED is standard. Red LED available on request.

|  |                    |                |
|--|--------------------|----------------|
| <b>99.80 coil indication and EMC suppression modules for 94.92.3 and 94.94.3 sockets</b> |                    | <b>Blue*</b>   |
| Diode (+A1, standard polarity)   | (6...220)V DC      | 99.80.3.000.00 |
| LED  | (6...24)V DC/AC    | 99.80.0.024.59 |
| LED  | (28...60)V DC/AC   | 99.80.0.060.59 |
| LED  | (110...240)V DC/AC | 99.80.0.230.59 |
| LED + Diode (+A1, standard polarity)   | (6...24)V DC       | 99.80.9.024.99 |
| LED + Diode (+A1, standard polarity)   | (28...60)V DC      | 99.80.9.060.99 |
| LED + Diode (+A1, standard polarity)   | (110...220)V DC    | 99.80.9.220.99 |
| LED + Varistor   | (6...24)V DC/AC    | 99.80.0.024.98 |
| LED + Varistor   | (28...60)V DC/AC   | 99.80.0.060.98 |
| LED + Varistor   | (110...240)V DC/AC | 99.80.0.230.98 |
| RC circuit   | (6...24)V DC/AC    | 99.80.0.024.09 |
| RC circuit   | (28...60)V DC/AC   | 99.80.0.060.09 |
| RC circuit   | (110...240)V DC/AC | 99.80.0.230.09 |
| Residual current by-pass*  | (110...240)V AC    | 99.80.8.230.07 |

\*Additional 0.9 W power dissipation

A



94.74

Approvals  
(according to type):



94.82

Approvals  
(according to type):



| Screw terminal (Plate clamp) socket panel or 35 mm (EN 60715) rail mount | 94.72                             | 94.72.0 | 94.73                  | 94.73.0 | 94.74        | 94.74.0 |
|--|-----------------------------------|---------|------------------------|---------|--------------|---------|
| For relay type   | Blue                              | Black   | Blue                   | Black   | Blue         | Black   |
| For relay type   | 55.32                             |         | 55.33                  |         | 55.32, 55.34 |         |
| <b>Accessories</b>   |                                   |         |                        |         |              |         |
| Metal retaining clip (supplied with socket - packaging code SMA)         |                                   |         |                        |         | 094.71       |         |
| Modules (see table below)  |                                   |         |                        |         | 99.01        |         |
| <b>Screw terminal (Plate clamp) socket: panel or 35 mm rail mount</b>    | <b>94.82 (blue)</b>               |         | <b>94.82.0 (black)</b> |         |              |         |
| For relay type   | 55.32                             |         | 55.32                  |         |              |         |
| <b>Accessories</b>   |                                   |         |                        |         |              |         |
| Metal retaining clip (supplied with socket - packaging code SMA)         |                                   |         |                        |         | 094.71       |         |
| Modules (see table below)  |                                   |         |                        |         | 99.01        |         |
| <b>Technical data</b>  |                                   |         |                        |         |              |         |
| Rated values   | 10 A - 250 V                      |         |                        |         |              |         |
| Dielectric strength  | 2 kV AC                           |         |                        |         |              |         |
| Protection category  | IP 20                             |         |                        |         |              |         |
| Ambient temperature  | °C -40...+70                      |         |                        |         |              |         |
| ⊕ Screw torque   | Nm 0.5                            |         |                        |         |              |         |
| Wire strip length  | mm 8 (94.72/73/74)                |         | mm 9 (94.82)           |         |              |         |
| Max. wire size for 94.72/73/74 and 94.82 sockets                         | solid wire                        |         | stranded wire          |         |              |         |
|  | mm <sup>2</sup> 1 x 2.5 / 2 x 1.5 |         | 1 x 2.5 / 2 x 1.5      |         |              |         |
|  | AWG 1 x 14 / 2 x 16               |         | 1 x 14 / 2 x 16        |         |              |         |

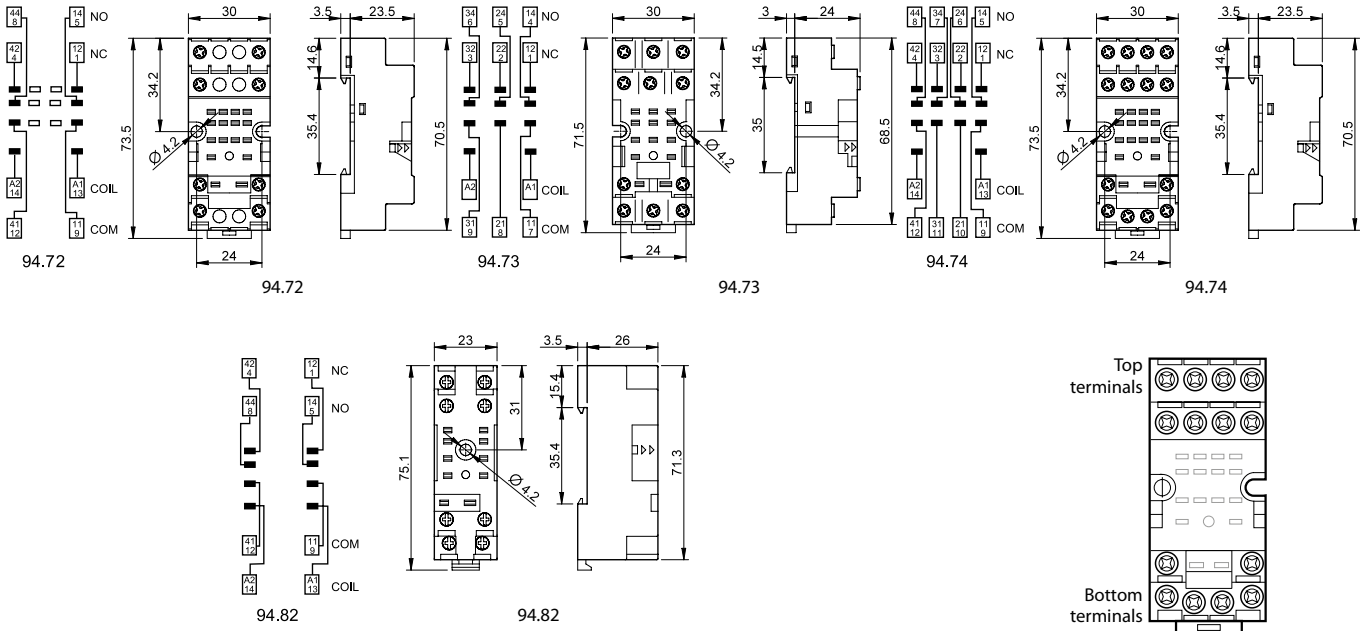

99.01

Approvals  
(according to type):



\* Modules in Black housing are available on request.

Green LED is standard.  
Red LED available on request.

| 99.01 coil indication and EMC suppression modules for 94.72, 94.73, 94.74 and 94.82 sockets |                    | Blue*          |
|---|--------------------|----------------|
| Diode (+A1, standard polarity)  | (6...220)V DC      | 99.01.3.000.00 |
| Diode (+A2, non standard polarity)  | (6...220)V DC      | 99.01.3.000.00 |
| LED   | (6...24)V DC/AC    | 99.01.0.024.59 |
| LED   | (28...60)V DC/AC   | 99.01.0.060.59 |
| LED   | (110...240)V DC/AC | 99.01.0.230.59 |
| LED + Diode (+A1, standard polarity)  | (6...24)V DC       | 99.01.9.024.99 |
| LED + Diode (+A1, standard polarity)  | (28...60)V DC      | 99.01.9.060.99 |
| LED + Diode (+A1, standard polarity)  | (110...220)V DC    | 99.01.9.220.99 |
| LED + Diode (+A2, non standard polarity)  | (6...24)V DC       | 99.01.9.024.79 |
| LED + Diode (+A2, non standard polarity)  | (28...60)V DC      | 99.01.9.060.79 |
| LED + Diode (+A2, non standard polarity)  | (110...220)V DC    | 99.01.9.220.79 |
| LED + Varistor  | (6...24)V DC/AC    | 99.01.0.024.98 |
| LED + Varistor  | (28...60)V DC/AC   | 99.01.0.060.98 |
| LED + Varistor  | (110...240)V DC/AC | 99.01.0.230.98 |
| RC circuit  | (6...24)V DC/AC    | 99.01.0.024.09 |
| RC circuit  | (28...60)V DC/AC   | 99.01.0.060.09 |
| RC circuit  | (110...240)V DC/AC | 99.01.0.230.09 |
| Residual current by-pass*   | (110...240)V AC    | 99.01.8.230.07 |

\*Additional 0.9 W power dissipation



A



94.14

Approvals  
(according to type):



| PCB socket  | 94.12<br>Blue | 94.12.0<br>Black | 94.13<br>Blue | 94.13.0<br>Black | 94.14<br>Blue | 94.14.0<br>Black |
|---|---------------|------------------|---------------|------------------|---------------|------------------|
| For relay type  | 55.32         |                  | 55.33         |                  | 55.32, 55.34  |                  |
| <b>Accessories</b>  |               |                  |               |                  |               |                  |
| Metal retaining clip<br>(supplied with socket - packaging code SMA) | 094.51        |                  |               |                  |               |                  |
| <b>Technical data</b>   |               |                  |               |                  |               |                  |
| Rated values  | 10 A - 250 V  |                  |               |                  |               |                  |
| Dielectric strength   | 2 kV AC       |                  |               |                  |               |                  |
| Ambient temperature   | °C -40...+70  |                  |               |                  |               |                  |

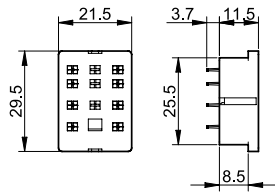

Copper side view

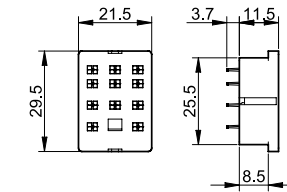

Copper side view

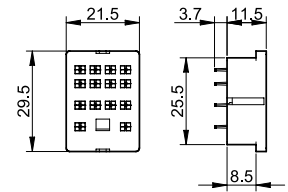

Copper side view

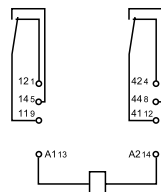
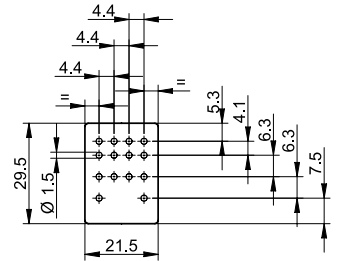
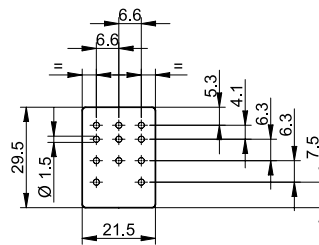
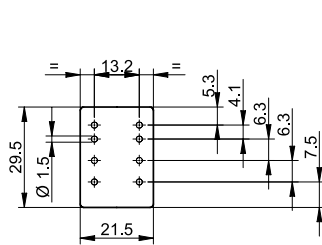

94.12

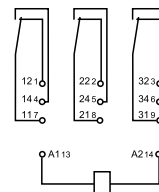

94.13



94.14



94.22

Approvals  
(according to type):



| Panel mount solder socket 1 mm thick panel                          | 94.22<br>Blue | 94.22.0<br>Black | 94.23<br>Blue | 94.23.0<br>Black | 94.24<br>Blue | 94.24.0<br>Black |
|---|---------------|------------------|---------------|------------------|---------------|------------------|
| For relay type  | 55.32         |                  | 55.33         |                  | 55.32, 55.34  |                  |
| <b>Accessories</b>  |               |                  |               |                  |               |                  |
| Metal retaining clip<br>(supplied with socket - packaging code SMA) | 094.51        |                  |               |                  |               |                  |
| <b>Technical data</b>   |               |                  |               |                  |               |                  |
| Rated values  | 10 A - 250 V  |                  |               |                  |               |                  |
| Dielectric strength   | 2 kV AC       |                  |               |                  |               |                  |
| Ambient temperature   | °C -40...+70  |                  |               |                  |               |                  |

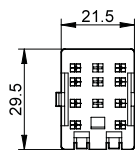

94.22

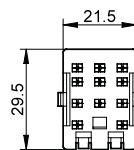

94.23

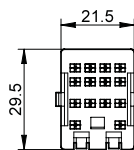

94.24

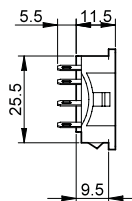



A

94.34

Approvals  
(according to type):



| Panel mount socket M3 screw fixing - solder connections             | 94.32<br>Blue | 94.32.0<br>Black | 94.33<br>Blue | 94.33.0<br>Black | 94.34<br>Blue | 94.34.0<br>Black |
|---|---------------|------------------|---------------|------------------|---------------|------------------|
| For relay type  | 55.32         |                  | 55.33         |                  | 55.32, 55.34  |                  |
| <b>Accessories</b>  |               |                  |               |                  |               |                  |
| Metal retaining clip<br>(supplied with socket - packaging code SMA) | 094.51        |                  |               |                  |               |                  |
| <b>Technical data</b>   |               |                  |               |                  |               |                  |
| Rated values  | 10 A - 250 V  |                  |               |                  |               |                  |
| Dielectric strength   | 2 kV AC       |                  |               |                  |               |                  |
| Ambient temperature   | °C -40...+70  |                  |               |                  |               |                  |

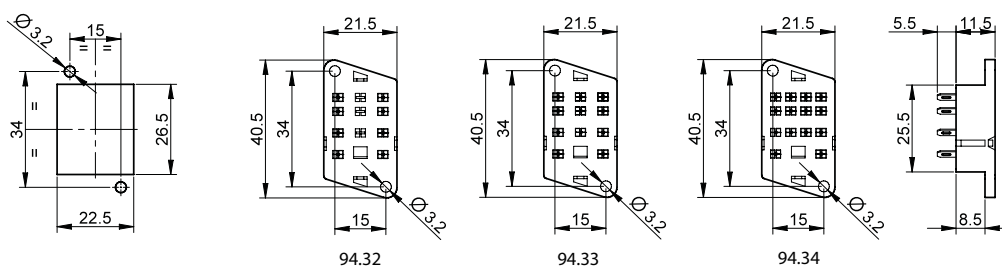

### Packaging codes

How to code and identify retaining clip and packaging options for sockets.

Example:



- A** Standard packaging
- SM** Metal retaining clip
- SP** Plastic retaining clip