

1. This specification shall be applied to the ESD Protection Device.

LXES11DAA2-135
LXES21DAA4-136
LXES11DAA2-137
LXES21DAA4-138
LXES21DAA4-140
LXES18DAA4-167
LXES0NDAA2-172
LXES18DAA4-182
LXES0NDAA2-183
LXES18DAA4-184
LXES0NDAA2-185

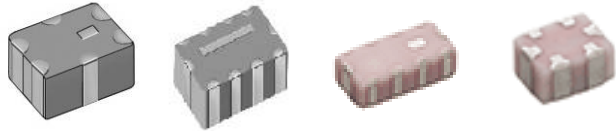

2. Part Number Configuration

LXES 11 D AA 2 - 135
① ② ③ ④ ⑤ ⑥

- ① Product ID (LXES = ESD Protection device)
- ② Dimension Code

Unit : mm

Code	Dimension
11	1.25 x 1.0
21	2.0 x 1.25
0N	0.87 x 0.67
18	1.6 x 0.8

- ③ Type (D : Common mode ESD filter)
- ④ Control Code
- ⑤ Number of channel
- ⑥ Serial Number

※RoHS Compliant
Halogen free
T/R only.

3.CONSTRUCTION, DIMENSIONS

3 - 1 DIMENSIONS

LXES11D series

Top View

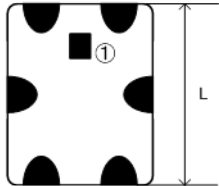

Side View 1



Side View 2



Bottom View

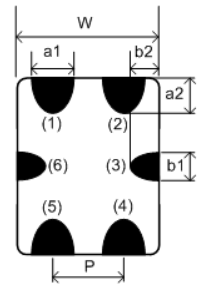

Unit : mm

Mark	Dimension
L	1.25 +/-0.1
W	1.0 +/-0.1
T	0.75 +/-0.1
a1	0.3 +/-0.1

Mark	Dimension
a2	0.25 +/-0.15
b1	0.2 +/-0.1
b2	0.2 +/-0.15
p	0.55 +/-0.05

LXES21Dseries

Top View

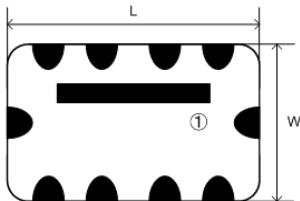

Side View 1



Side View 2



Bottom View

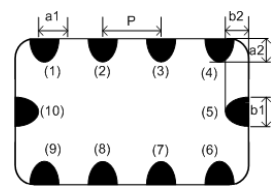

Unit : mm

Mark	Dimension
L	2.0 +/-0.1
W	1.25 +/-0.1
T	0.80 +0.1/-0.05
a1	0.25 +/-0.1

Mark	Dimension
a2	0.2 +/-0.15
b1	0.25 +/-0.1
b2	0.2 +/-0.15
p	0.5 +/-0.05

LXES0NDseries

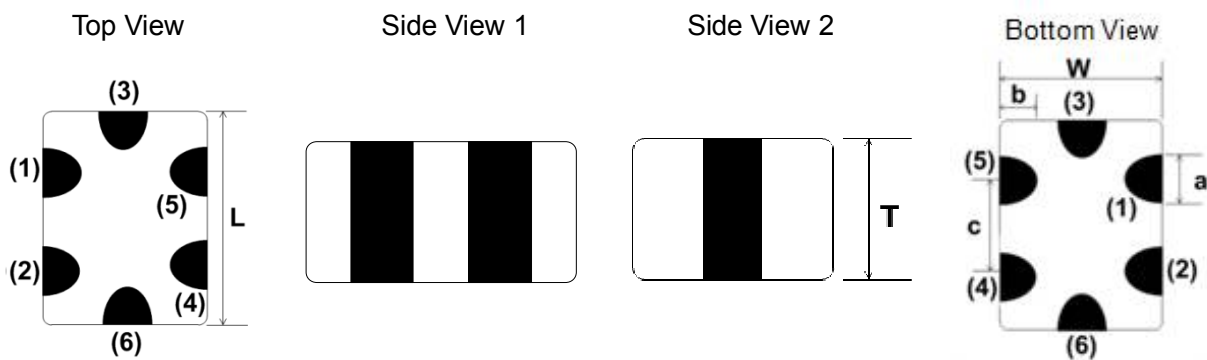

Unit : mm

Mark	Dimension
L	0.87 ± 0.05
W	0.67 ± 0.05
T	0.47 ± 0.05

Mark	Dimension
a	0.20 ± 0.05
b	0.15 ± 0.05
c	0.40 ± 0.05

LXES18Dseries

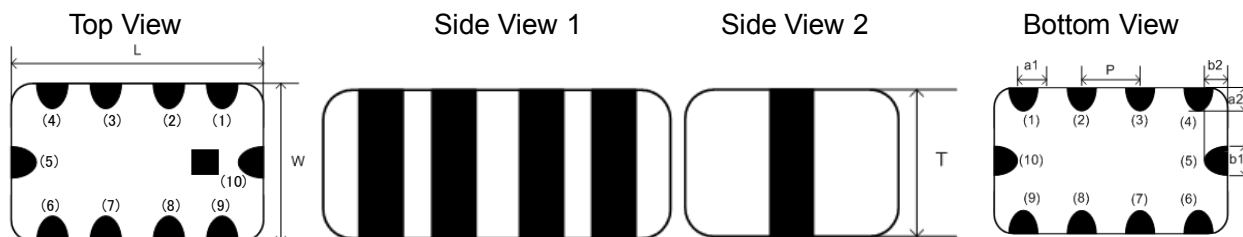

Unit : mm

Mark	Dimension
L	1.6 ± 0.1
W	0.8 ± 0.1
T	0.5 ± 0.05
a1	0.2 ± 0.1

Mark	Dimension
a2	0.15 ± 0.1
b1	0.2 ± 0.1
b2	0.15 ± 0.1
p	0.4 ± 0.05

3 - 2 Circuit Diagram

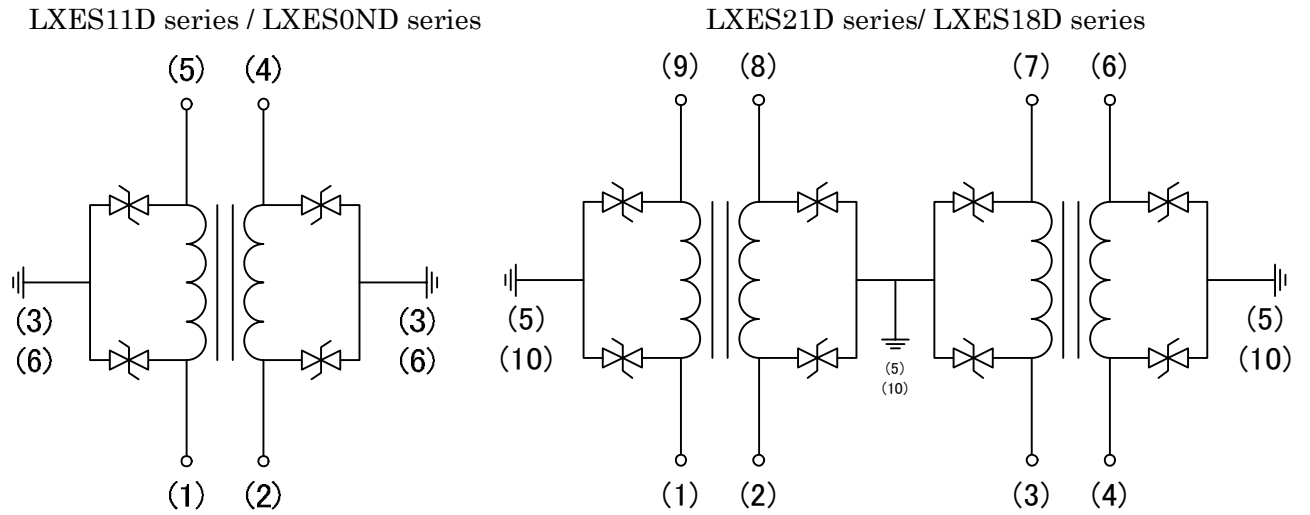

TERMINAL CONFIGURATION
This device is bi-directional.

3 - 3 Product Weight

P/N	Weight [mg]
LXES11D series	3.0
LXES21D series	7.1
LXES0ND series	1.0
LXES18D series	2.3

4.CHARACTERISTICS

4 - 1 Ratings

Parameter	Rating	Unit
Rated Voltage	5	V
Rated Current	60	mA
Operating Temperature	-40 to +85	°C
Storage Temperature	-40 to +85	°C

4 - 2 Electrical Characteristics (T=25°C)

P/N	Parameter	Conditions	MIN	TYP	MAX	Units
LXES11DAA2-135 LXES21DAA4-136	Common mode impedance	@100MHz		60		Ω
	DC Resistance			3		Ω
	Capacitance	1MHz、Vbias=0V		0.4		pF
	ESD per IEC 61000-4-2 (Air)		-15		15	kV
	ESD per IEC 61000-4-2 (Contact)		-15		15	kV

P/N	Parameter	Conditions	MIN	TYP	MAX	Units
LXES11DAA2-137 LXES21DAA4-138	Common mode impedance	@100MHz		35		Ω
	DC Resistance			2		Ω
	Capacitance	1MHz、Vbias=0V		0.4		pF
	ESD per IEC 61000-4-2 (Air)		-15		15	kV
	ESD per IEC 61000-4-2 (Contact)		-15		15	kV

P/N	Parameter	Conditions	MIN	TYP	MAX	Units
LXES21DAA4-140	Common mode impedance	@100MHz		90		Ω
	DC Resistance			4		Ω
	Capacitance	1MHz、Vbias=0V		0.4		pF
	ESD per IEC 61000-4-2 (Air)		-15		15	kV
	ESD per IEC 61000-4-2 (Contact)		-15		15	kV

P/N	Parameter	Conditions	MIN	TYP	MAX	Units
LXES18DAA4-167	Common mode impedance	@100MHz		90		Ω
	DC Resistance			5		Ω
	Capacitance	1MHz、Vbias=0V		0.4		pF
	ESD per IEC 61000-4-2 (Air)		-15		15	kV
	ESD per IEC 61000-4-2 (Contact)		-15		15	kV

P/N	Parameter	Conditions	MIN	TYP	MAX	Units
LXES0NDAA2-172	Common mode impedance	@100MHz		75		Ω
	DC Resistance			5		Ω
	Capacitance	1MHz、Vbias=0V		0.4		pF
	ESD per IEC 61000-4-2 (Air)		-15		15	kV
	ESD per IEC 61000-4-2 (Contact)		-15		15	kV

P/N	Parameter	Conditions	MIN	TYP	MAX	Units
LXES18DAA4-182 LXES0NDAA2-183	Common mode impedance	@100MHz		25		Ω
	DC Resistance			4		Ω
	Capacitance	1MHz、Vbias=0V		0.4		pF
	ESD per IEC 61000-4-2 (Air)		-15		15	kV
	ESD per IEC 61000-4-2 (Contact)		-15		15	kV

P/N	Parameter	Conditions	MIN	TYP	MAX	Units
LXES18DAA4-184 LXES0NDAA2-185	Common mode impedance	@100MHz		50		Ω
	DC Resistance			5		Ω
	Capacitance	1MHz、Vbias=0V		0.4		pF
	ESD per IEC 61000-4-2 (Air)		-15		15	kV
	ESD per IEC 61000-4-2 (Contact)		-15		15	kV

4 - 3 Typical Characteristic

LXES11DAA2-135

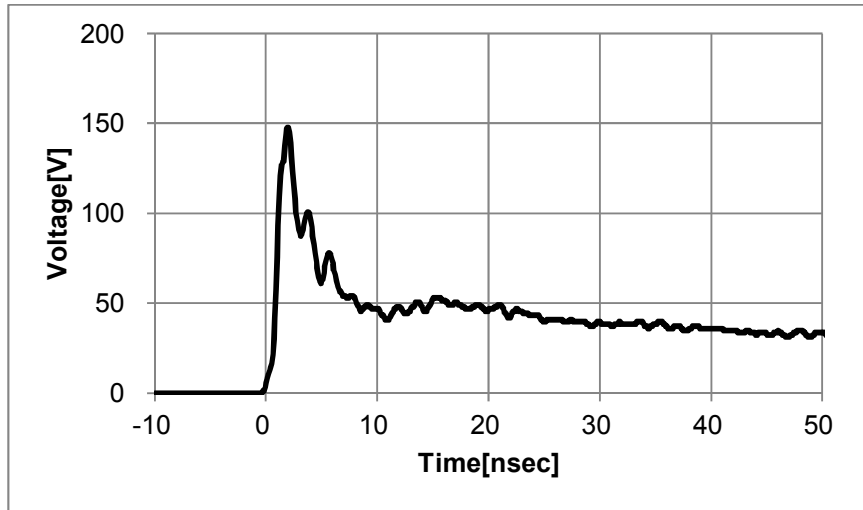

ESD Waveform (IEC61000-4-2:8kV Contact)

LXES21DAA4-136

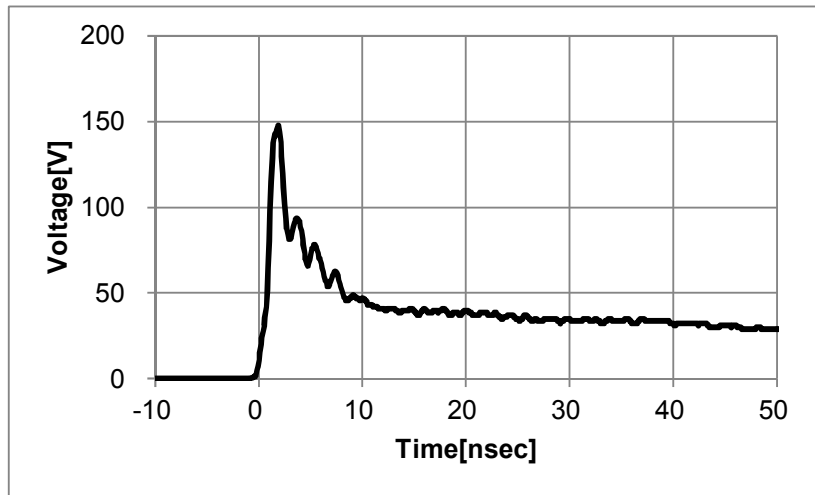

ESD Waveform (IEC61000-4-2:8kV Contact)

LXES11DAA2-137

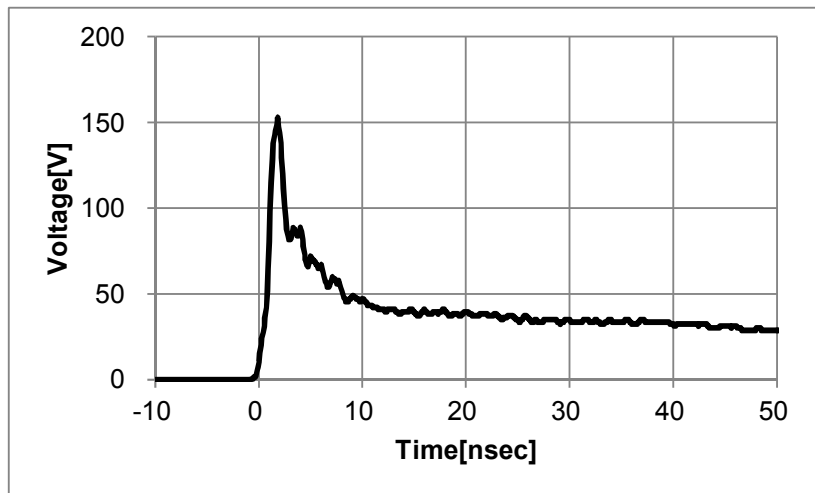

ESD Waveform (IEC61000-4-2:8kV Contact)

LXES21DAA4-138

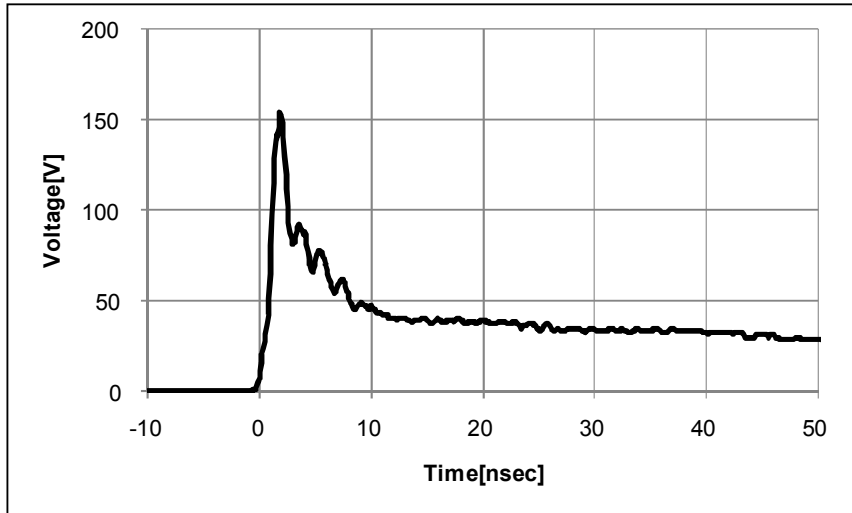

ESD Waveform (IEC61000-4-2:8kV Contact)

LXES21DAA4-140

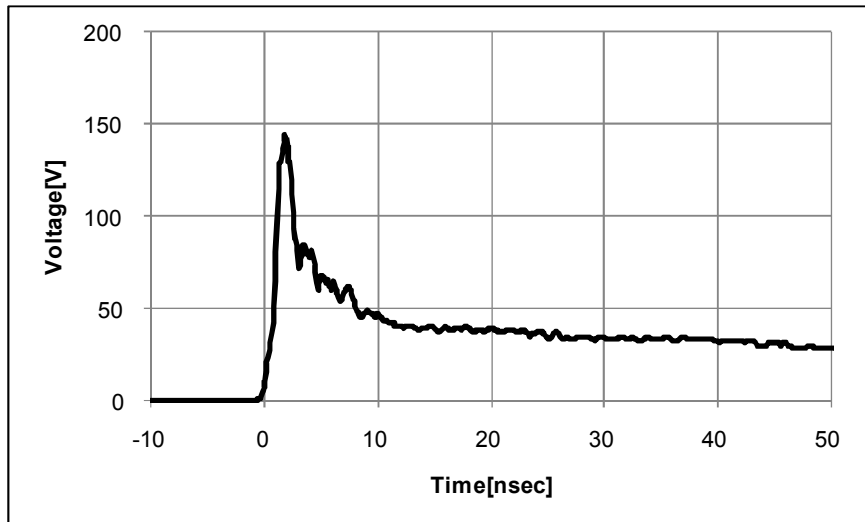

ESD Waveform (IEC61000-4-2:8kV Contact)

LXES18DAA4-167

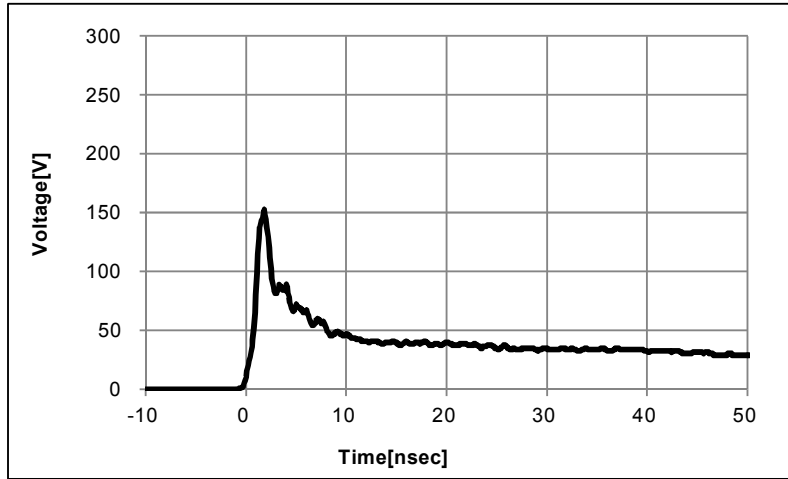

ESD Waveform (IEC61000-4-2: 8kV Contact)

LXES0NDAA2-172

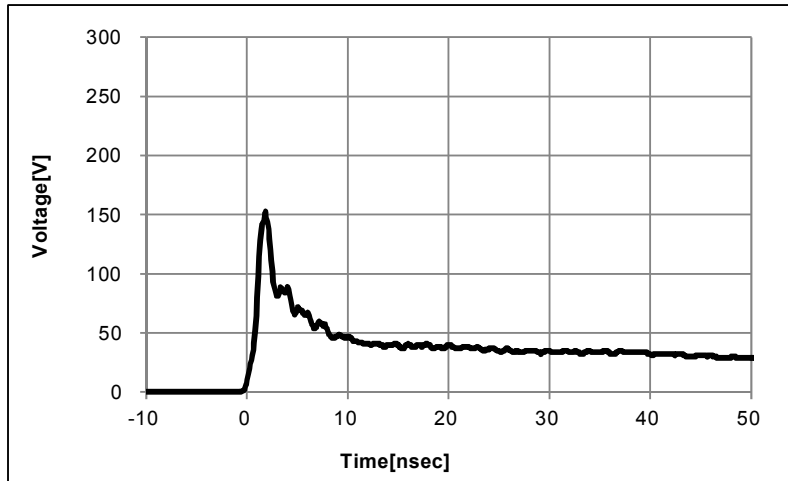

ESD Waveform (IEC61000-4-2: 8kV Contact)

LXES18DAA4-182

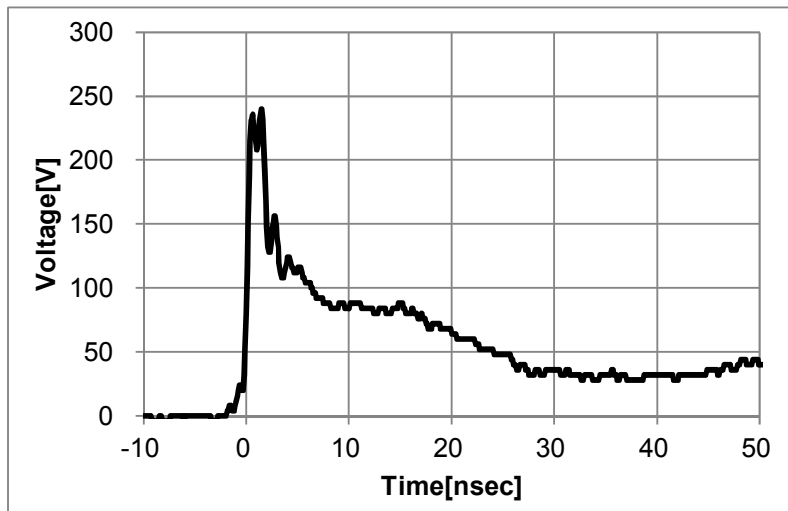

ESD Waveform (IEC61000-4-2: 8kV Contact)

LXES18DAA4-183

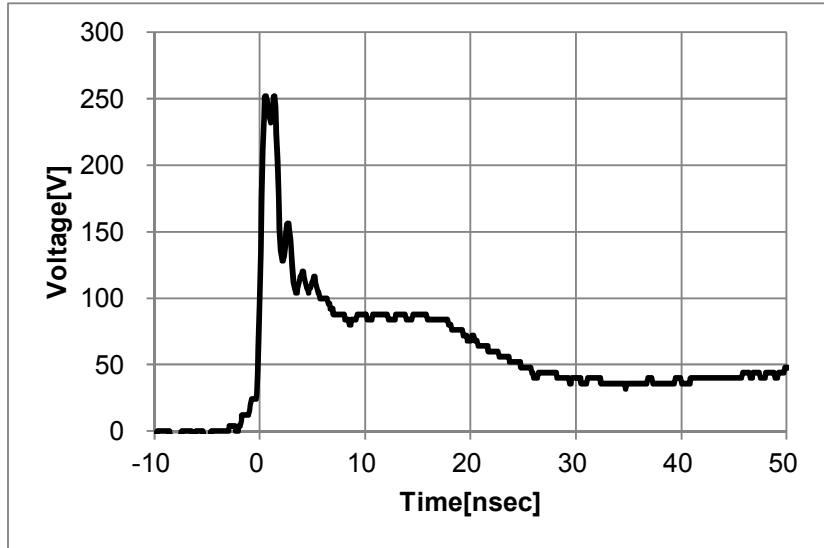

ESD Waveform (IEC61000-4-2:8kV Contact)

LXES18DAA4-184

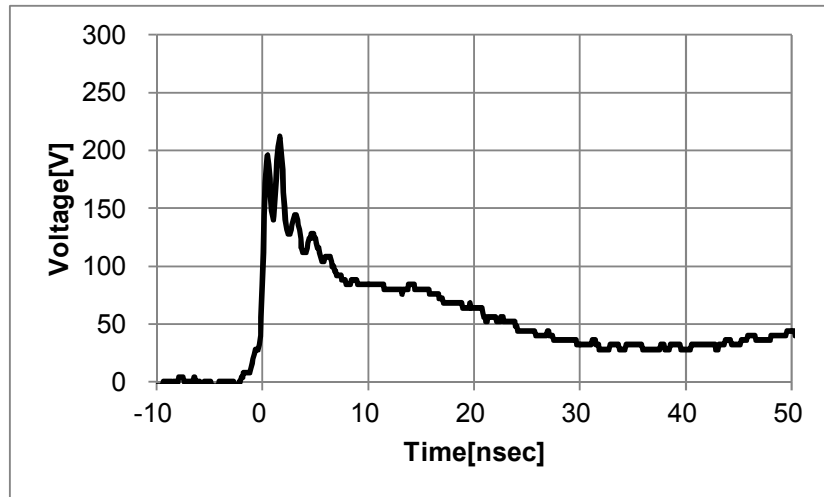

ESD Waveform (IEC61000-4-2:8kV Contact)

LXES0NDAA2-185

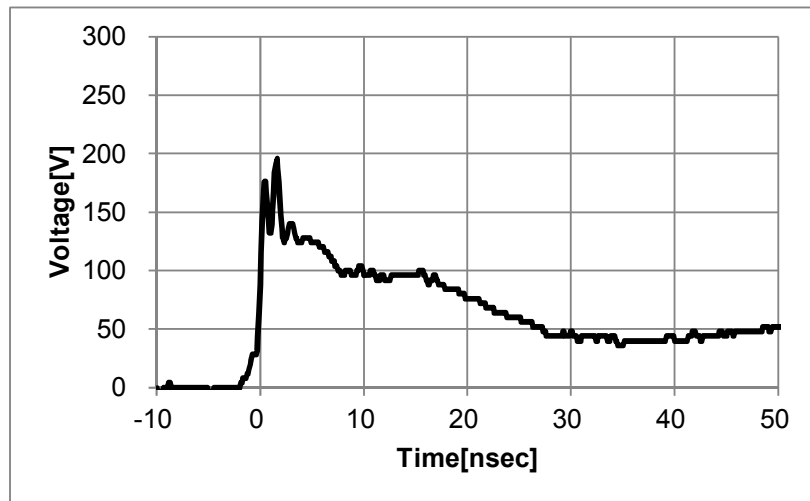

ESD Waveform (IEC61000-4-2:8kV Contact)

S parameter

LXES11DAA2-135

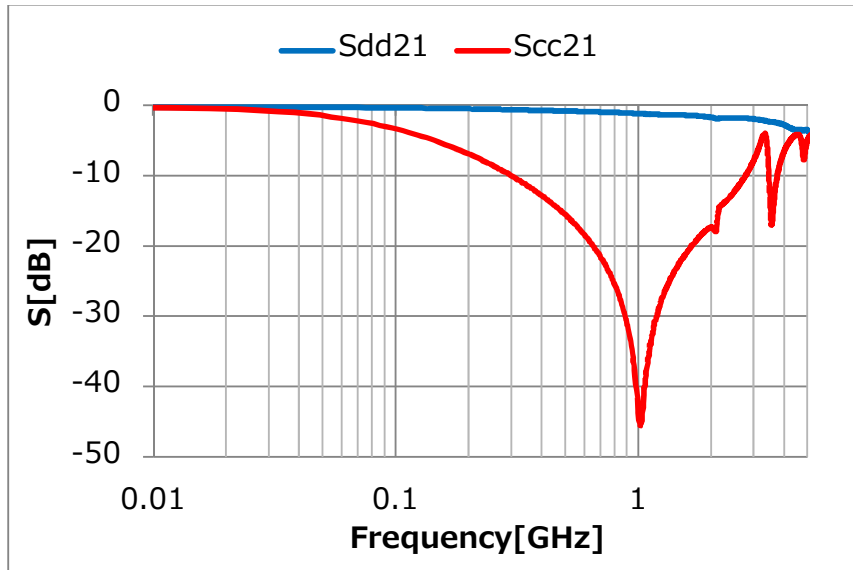

LXES21DAA4-136

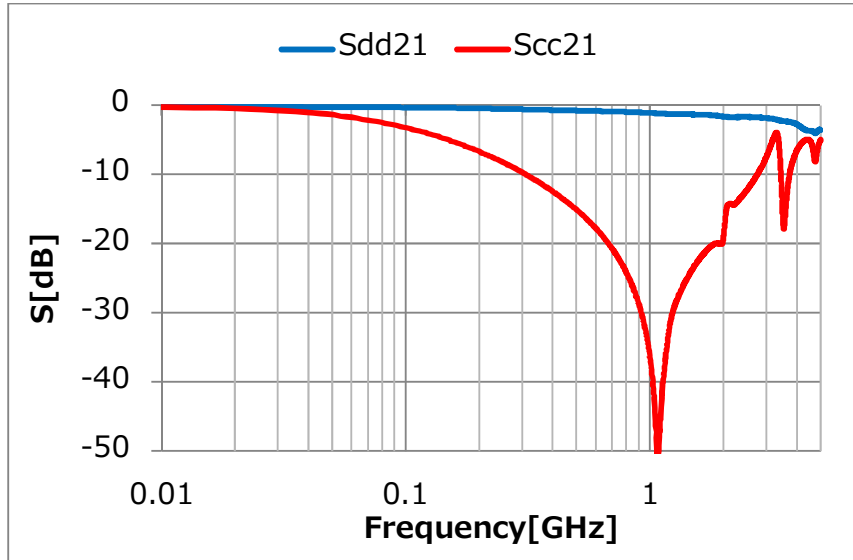

LXES11DAA2-137

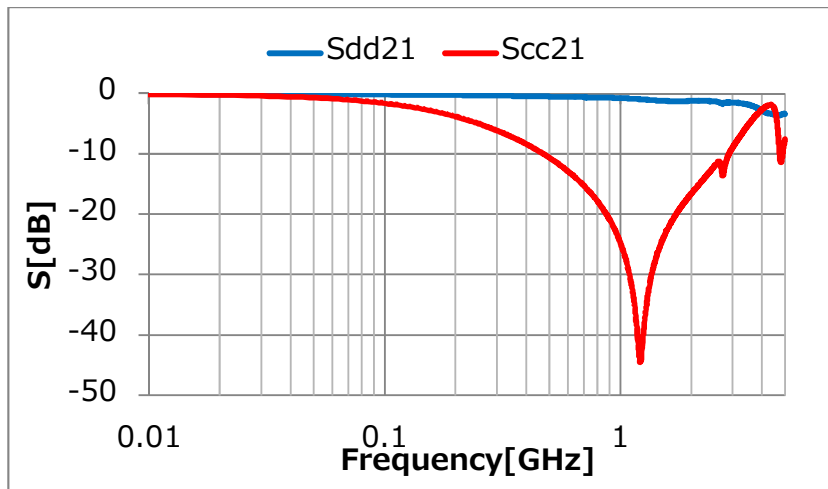

LXES21DAA4-138

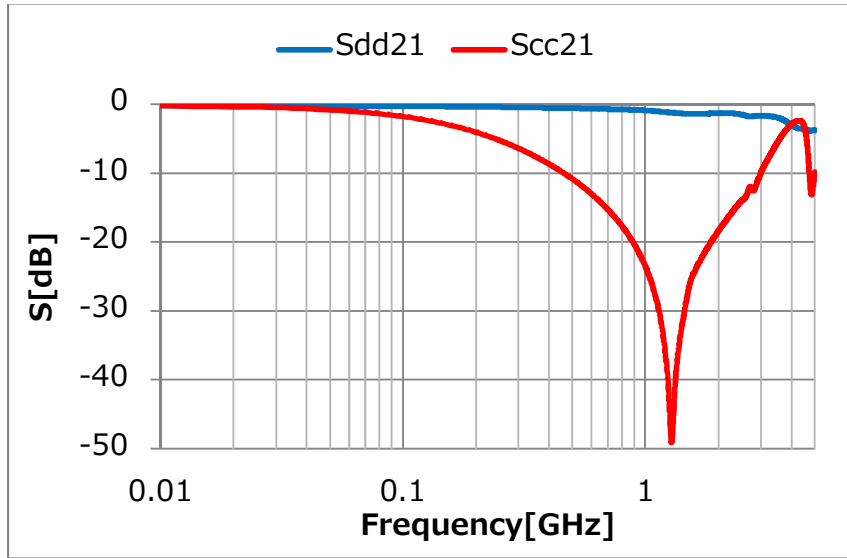

LXES21DAA4-140

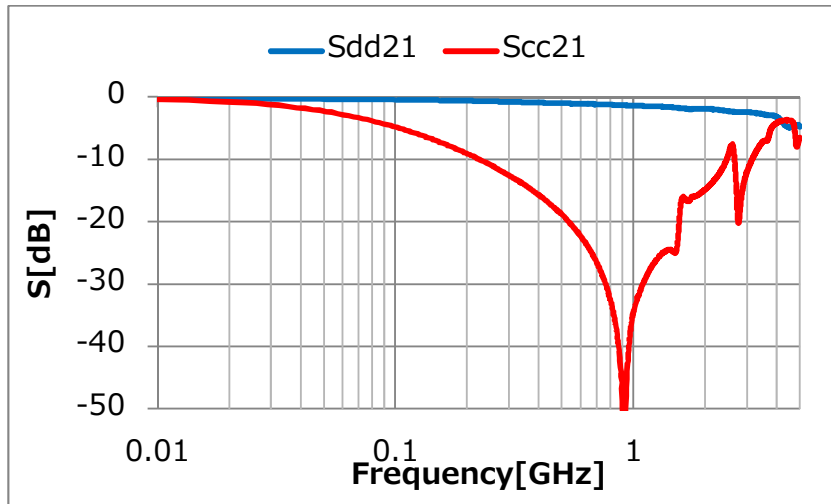

LXES18DAA4-167

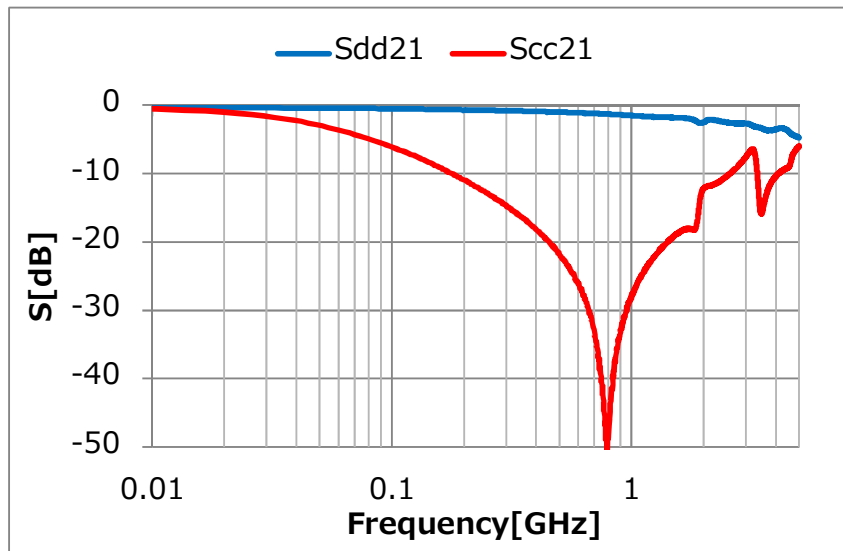

LXES0NDAA2-172

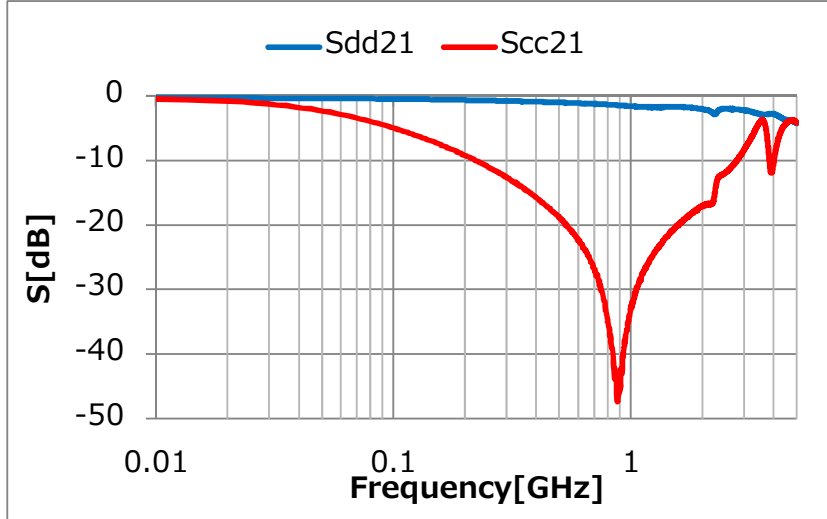

LXES18DAA4-182

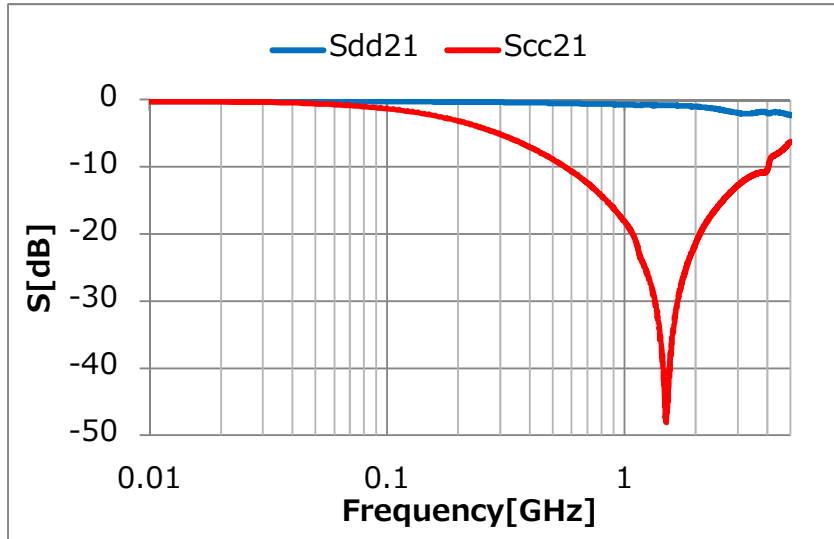

LXES0NDAA2-183

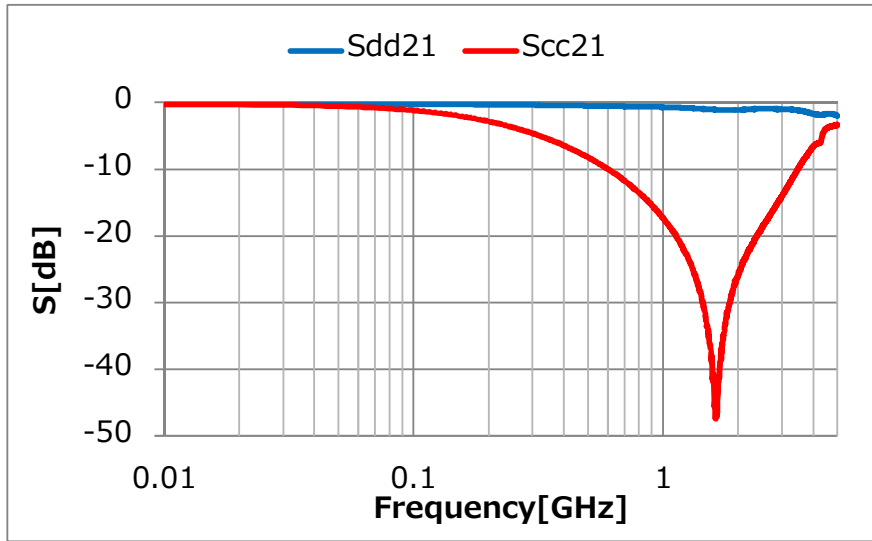

LXES18DAA4-184

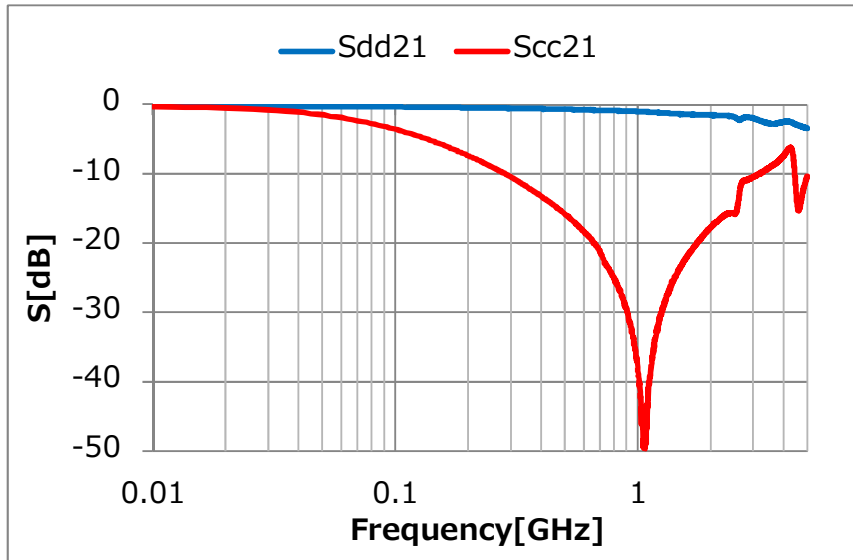

LXES0NDAA2-185

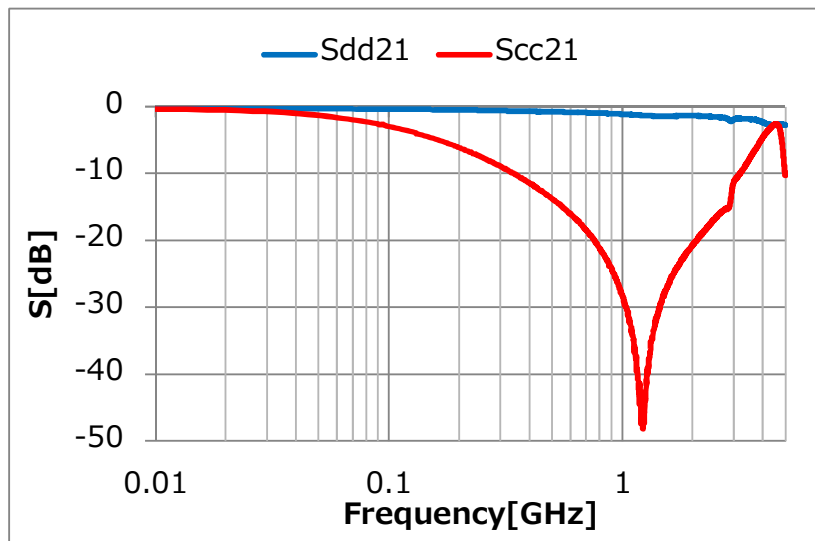

Signal Integrity HDMI 1080P 48bit
0ohm

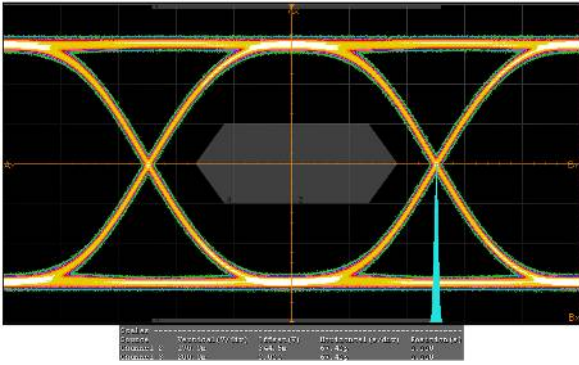

w/t LXES11DAA2-135

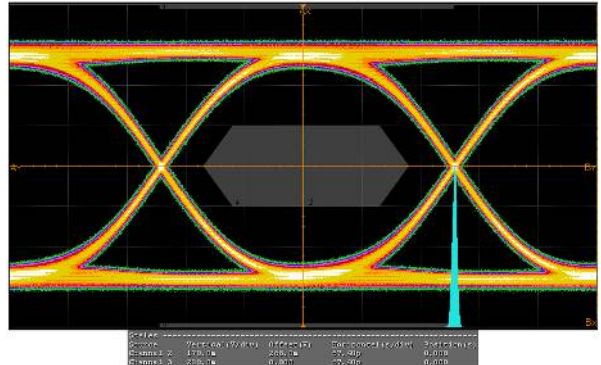

Signal Integrity USB2.0
0ohm

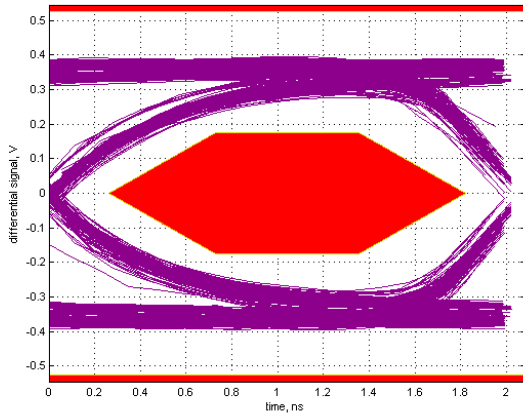

w/t LXES11DAA2-135

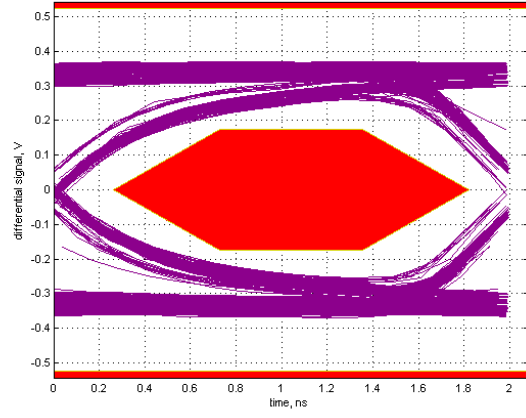

Signal Integrity USB3.0
0ohm

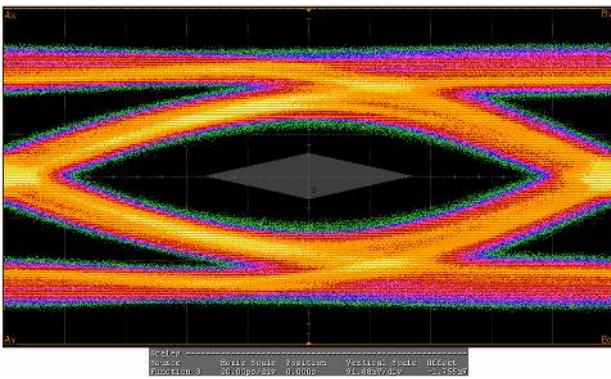

w/t LXES11DAA2-135

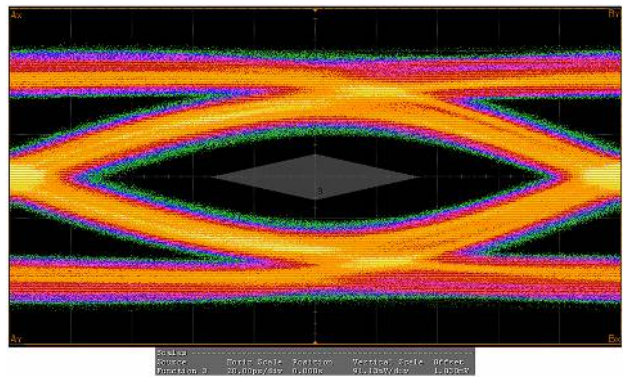

Signal Integrity HDMI 1080P 48bit
0ohm

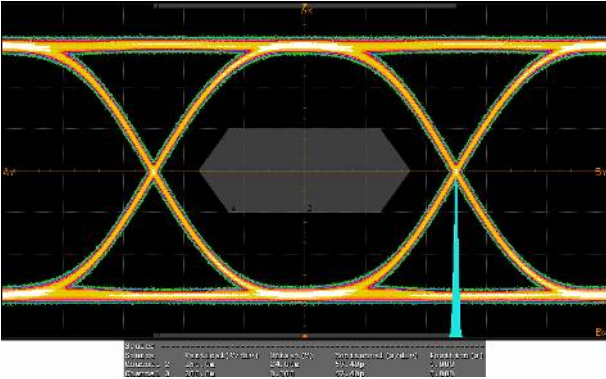

w/t LXES21DAA4-136

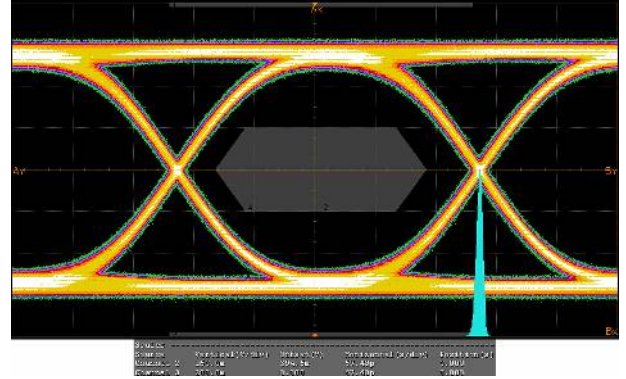

Signal Integrity USB2.0
0ohm

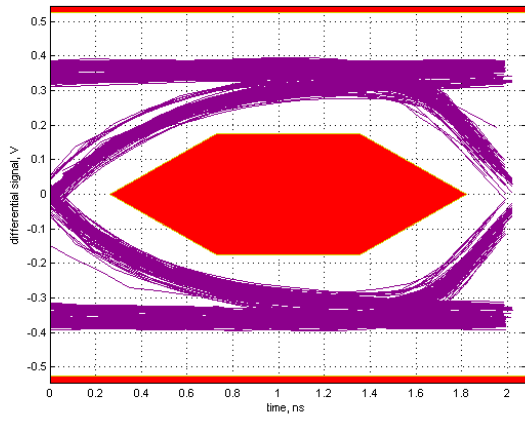

w/t LXES21DAA4-136

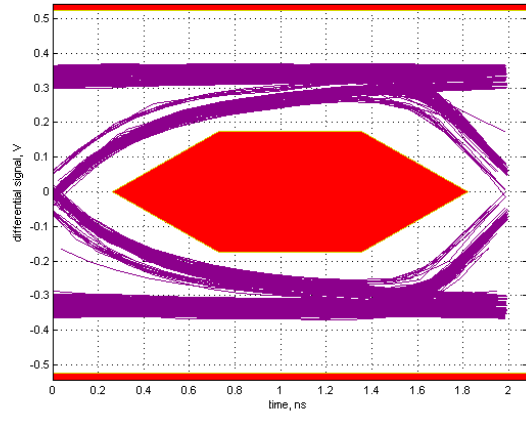

Signal Integrity USB3.0
0ohm

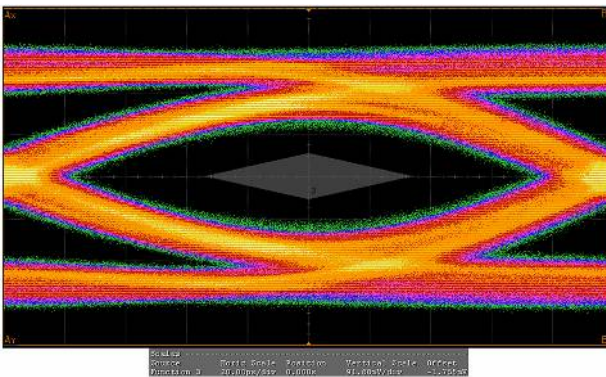

w/t LXES21DAA4-136

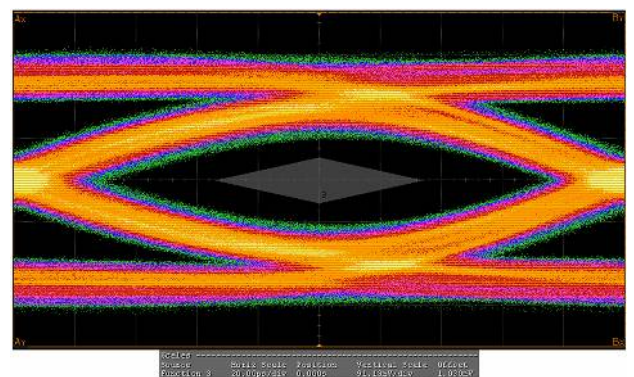

Signal Integrity HDMI 1080P 48bit
0ohm

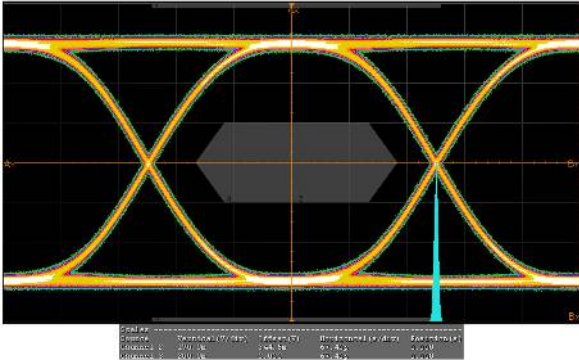

w/t LXES11DAA2-137

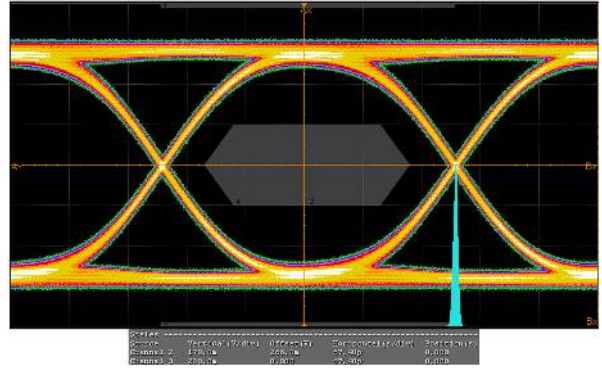

Signal Integrity USB2.0
0ohm

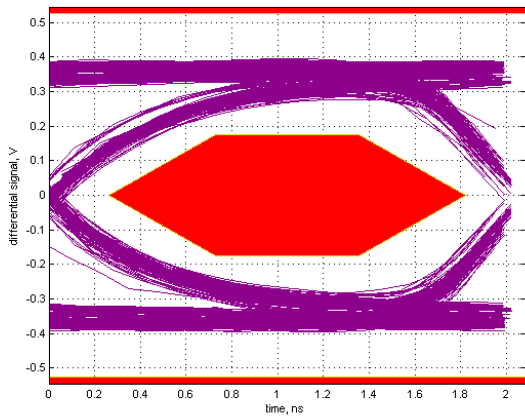

w/t LXES11DAA2-137

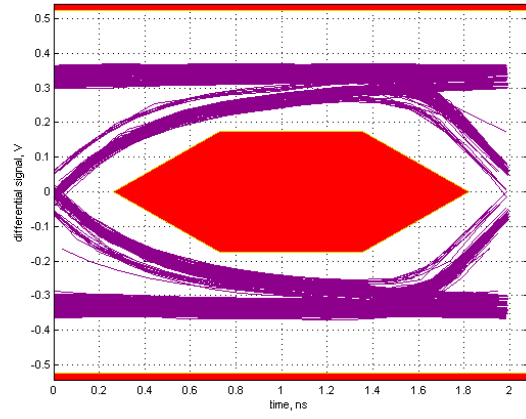

Signal Integrity USB3.0
0ohm

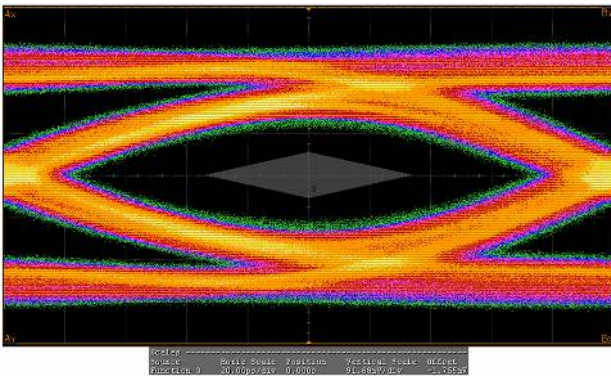

w/t LXES11DAA2-137

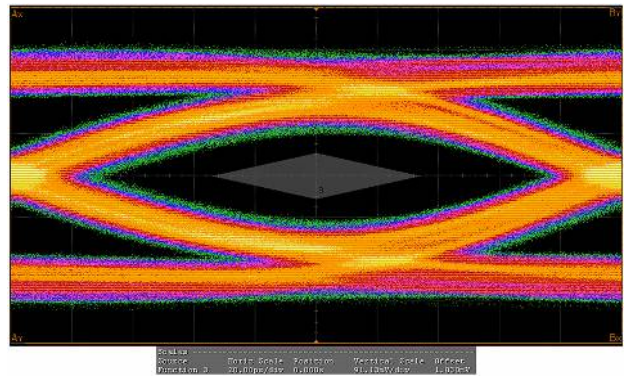

Signal Integrity HDMI 1080P 48bit
0ohm

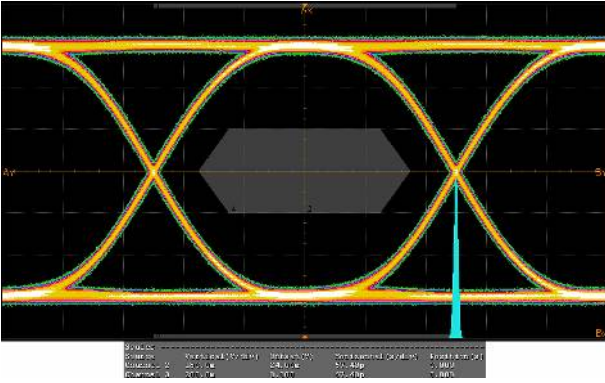

w/t LXES21DAA4-138

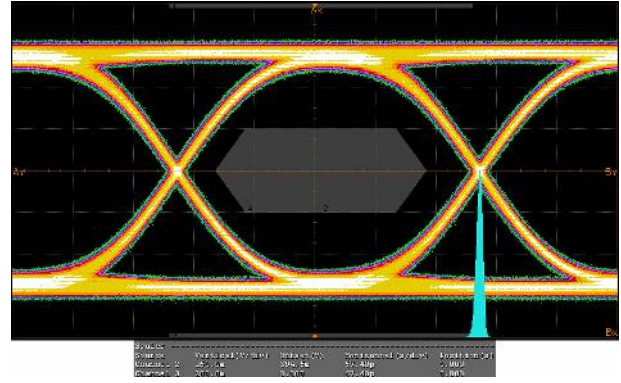

Signal Integrity USB2.0
0ohm

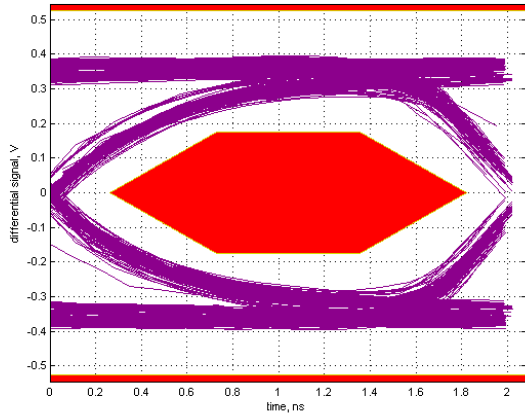

w/t LXES21DAA4-138

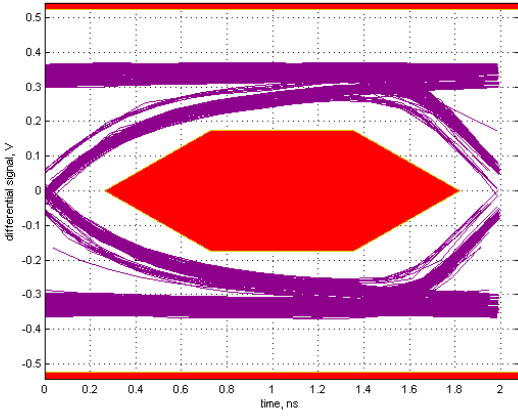

Signal Integrity USB3.0
0ohm

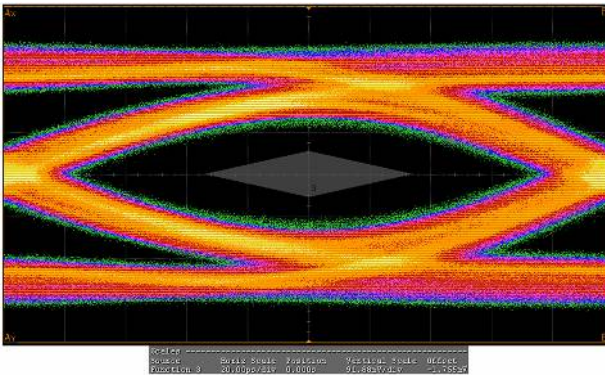

w/t LXES21DAA4-138

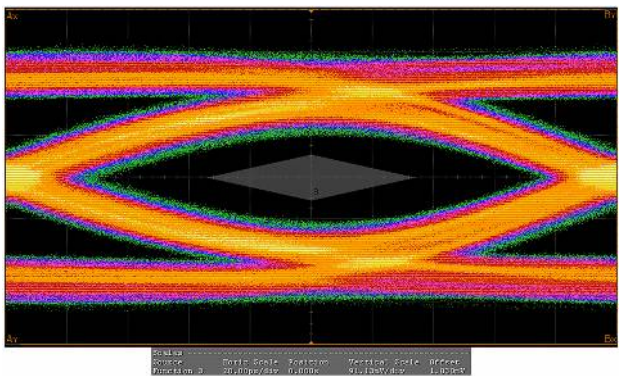

Signal Integrity HDMI 1080P 48bit
0ohm

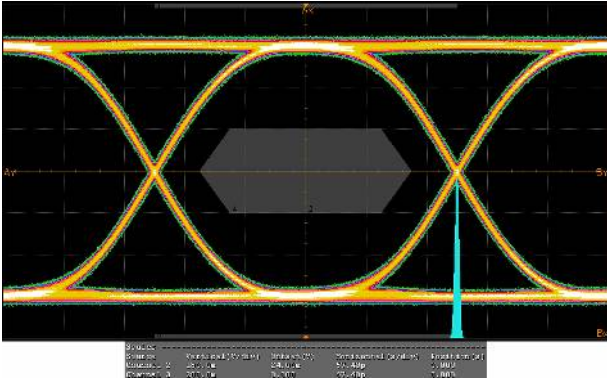

w/t LXES21DAA4-140

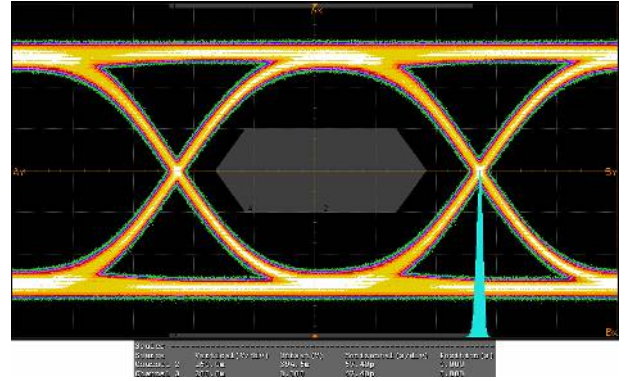

Signal Integrity USB2.0
0ohm

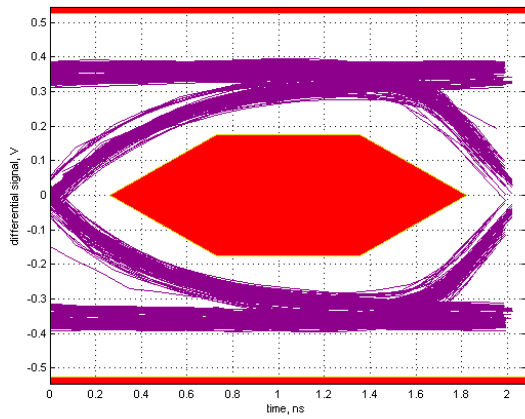

w/t LXES21DAA4-140

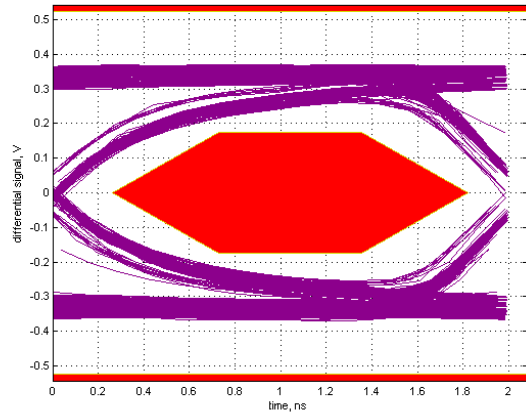

Signal Integrity USB3.0
0ohm

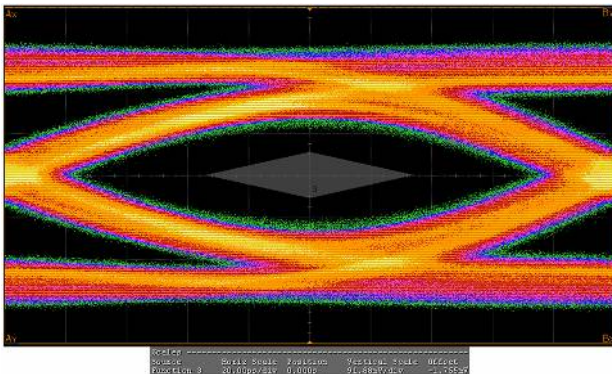

w/t LXES21DAA4-140

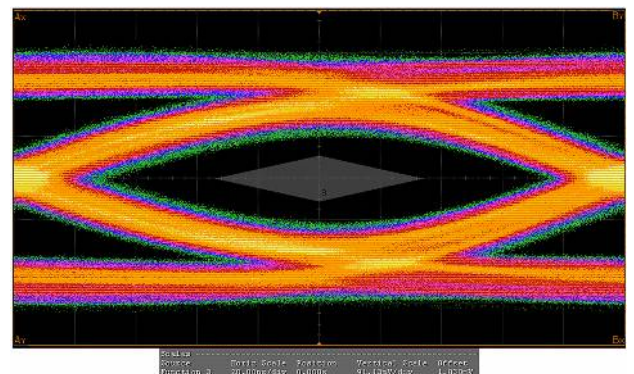

5.Reliability Test

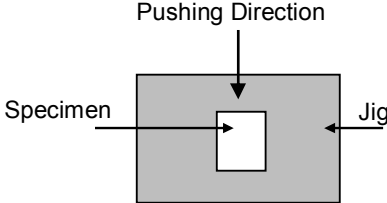
No.	Items		Specifications	Test Methods	Number	Result (Fail)
1	Vibration Resistance		No severe damages Satisfy dimension specifications	Solder specimens on the testing jig (glass fluorine boards) shown in appended Fig.1 by a Pb free solder. The soldering shall be done either by iron or reflow and be conducted with care so that the soldering is uniform and free of defect such as by heat shock. Frequency : 10~2000 Hz Acceleration : 196 m/s ² Direction : X,Y,Z 3 axis Period : 2 h on each direction Total 6 h.	22	G (0)
2	Shock			Solder specimens on the testing jig (glass fluorine boards) shown in appended Fig.1 by a Pb free solder. The soldering shall be done either by iron or reflow and be conducted with care so that the soldering is uniform and free of defect such as by heat shock Acceleration : 14,700 m/s ² Period : 0.3 ms. Cycle : 3 times	22	G (0)
3	Deflection			Solder specimens on the testing jig (glass epoxy boards) shown in appended Fig.2 by a Pb free solder. The soldering shall be done either by iron or reflow and be conducted with care so that the soldering is uniform and free of defect such as by heat shock. No damage with 1.6mm deflection	22	G (0)
4	Soldering strength (Push Strength)		5N Minimum	Solder specimens onto test jig shown below. Apply pushing force at 0.5mm/s until electrode pads are peeled off or ceramics are broken. Pushing force is applied to longitudinal direction. 	22	G (0)
5	Solderability of Termination		95% of the terminations is to be soldered evenly and continuously.	Immerse specimens first an ethanol solution of rosin, then in a Pb free solder solution for 3±0.5 sec. at 245±5 °C. Preheat : 100-120 °C, 60 sec. Solder Paste : Sn-3.0Ag-0.5Cu Flux : Solution of ethanol and rosin (25 % rosin in weight proportion)	22	G (0)
6	Resistance to Soldering Heat (Reflow)	Appearance Electrical specifications	No severe damages Satisfy specifications listed in paragraph 4-2 over operational temperature range	Preheat Temperature : 150-200 °C Preheat Period : 120+/-60 s High Temperature : 217 °C High Temp. Period : 105+/-45 s Peak Temperature : 260+0/-5 °C Specimens are soldered twice with the above condition, and then kept in room condition for 24 h before measurements.	22	G (0)

No.	Items		Specifications	Test Methods	Number	Result (Fail)									
7	High Temp. Exposure	Appearance	No severe damages	Temperature : 85±2/-0 °C Period : 1000+48/-0 h Room Condition : 2 ~ 24 h	22	G (0)									
8	Temperature Cycle	Electrical Specifications	Satisfy specifications listed in paragraph 4-2 over operational temperature range	Set the specimens to the supporting jig in the same manner and under the same conditions as Fig.1 and conduct the 100 cycles according to the temperatures and time shown in the following table. Set it for 2 to 24 h at room temperature, then measure.	22	G (0)									
				<table border="1"> <thead> <tr> <th>Step</th> <th>Temp(°C)</th> <th>Time(min)</th> </tr> </thead> <tbody> <tr> <td>1</td> <td>Min. Operating Temp.+0/-3</td> <td>30±3</td> </tr> <tr> <td>2</td> <td>Max. Operating Temp.+3/-0</td> <td>30±3</td> </tr> </tbody> </table>			Step	Temp(°C)	Time(min)	1	Min. Operating Temp.+0/-3	30±3	2	Max. Operating Temp.+3/-0	30±3
Step	Temp(°C)			Time(min)											
1	Min. Operating Temp.+0/-3			30±3											
2	Max. Operating Temp.+3/-0	30±3													
9	Humidity (Steady State)	Temperature: 85±2 °C Humidity: 80~90 %RH Period: 1000+48/-0 h Room Condition: 2 ~ 24 h	22	G (0)											
10	Low Temp. Exposure	Temperature: -40±2 °C Period: 1000+48/-0 h Room Condition: 2 ~ 24 h	22	G (0)											

Fig. 1
Reference Land Pattern

LXES11D series

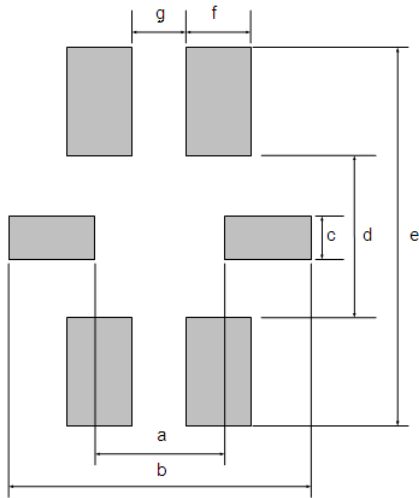

Unit : mm

Mark	Dimension
a	0.6
b	1.4
c	0.2
d	0.75

Mark	Dimension
e	1.75
f	0.3
g	0.25

Notes : this land layout is for reference purpose only.

LXES21D series

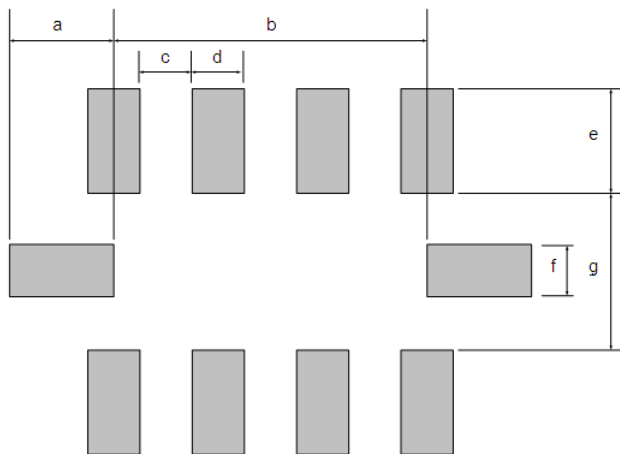

Unit : mm

Mark	Dimension
a	0.5
b	1.5
c	0.25
d	0.25

Mark	Dimension
e	0.5
f	0.25
g	0.75

Notes : this land layout is for reference purpose only.

LXES0ND series

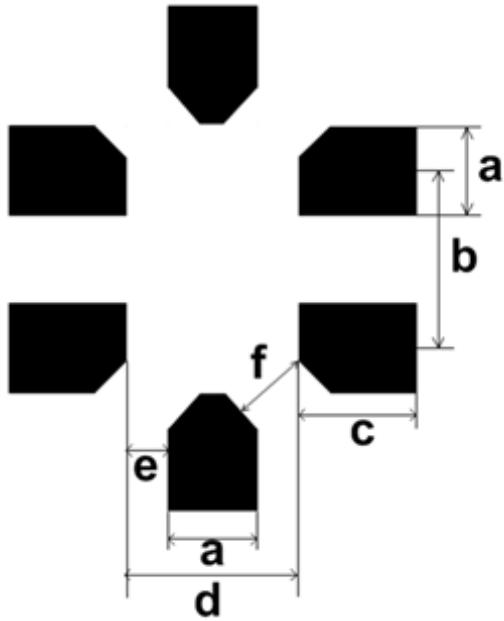

Unit : mm

Mark	Dimension
a	0.2
b	0.4
c	0.265

Mark	Dimension
d	0.39
e	0.095
f	0.17

Notes: this land layout is for reference purpose only.

LXES18D series

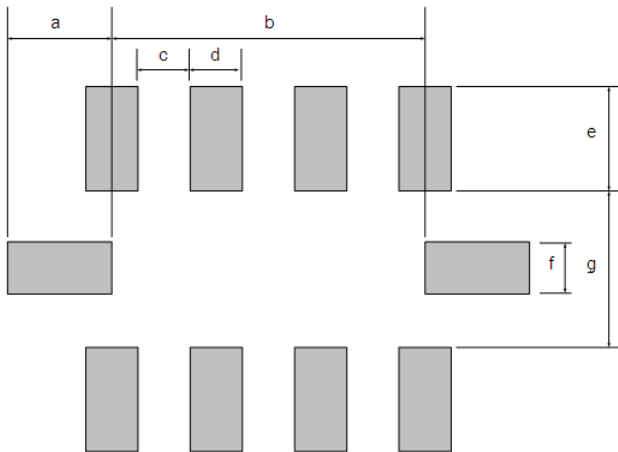

Unit : mm

Mark	Dimension
a	0.35
b	1.3
c	0.2
d	0.2

Mark	Dimension
e	0.47
f	0.15
g	0.48

Notes : this land layout is for reference purpose only.

Fig. 2
Testing board

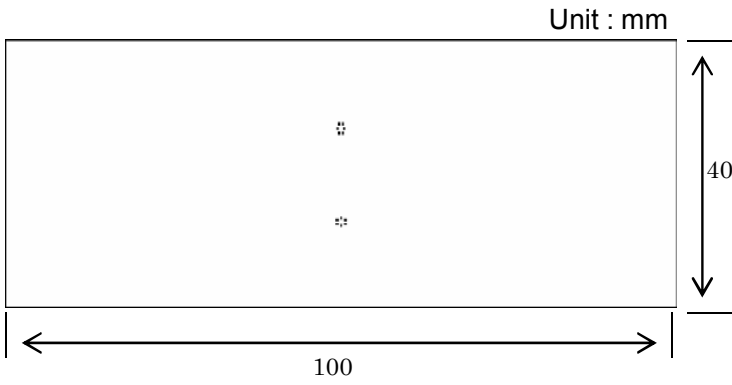

■ Land
Land pattern is same as figure1
Glass-fluorine board $t=1.6\text{mm}$
Copper thickness over $35\ \mu\text{m}$

Mounted situation

(Unit : mm)

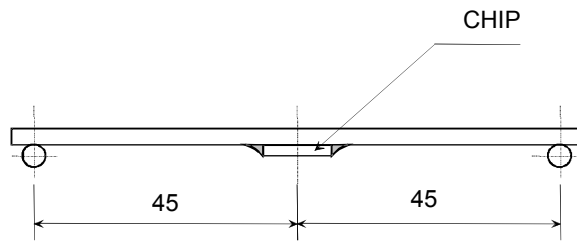

Test method

(Unit : mm)

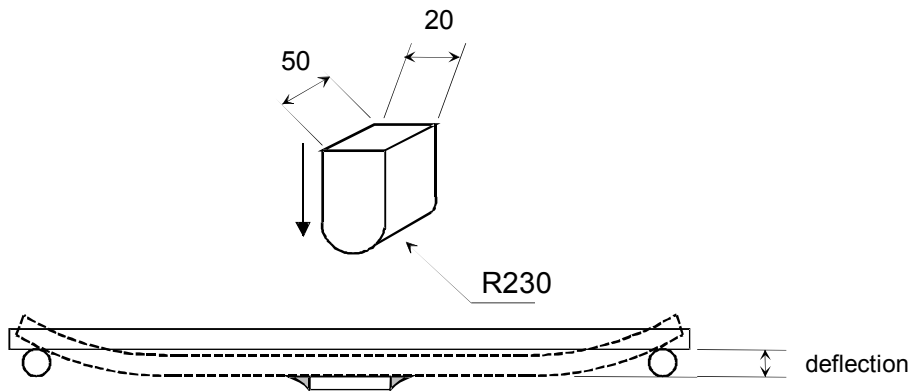

6. Tape and Reel Packing

(1) LXES11D series

Dimensions of Tape

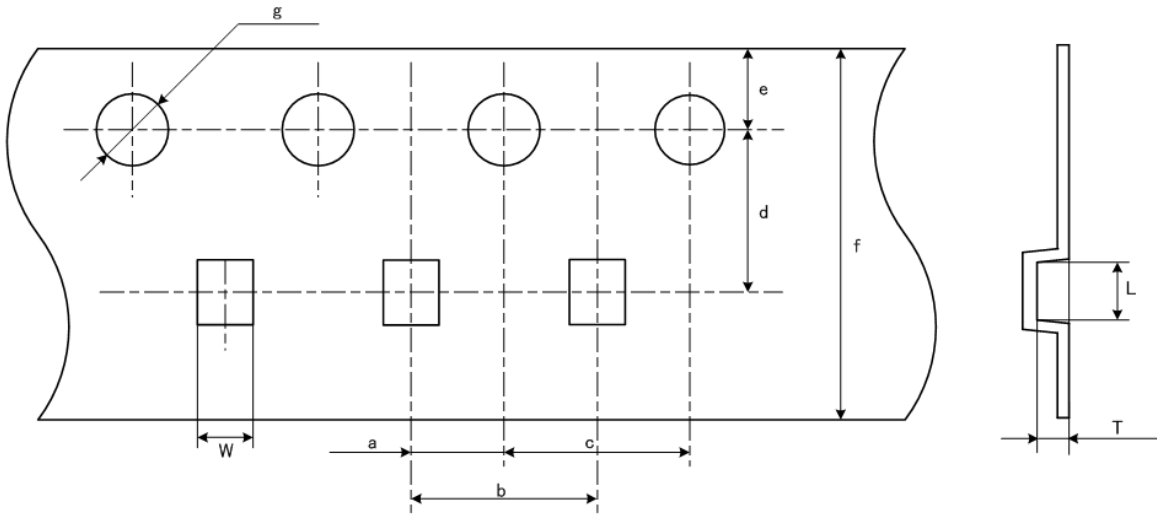

Unit : mm

Mark	Dimension
L	(1.40)
W	(1.20)
T	1.03 max
a	2.00 +/-0.05
b	4.00 +/-0.1

Mark	Dimension
c	4.00 +/-0.1
d	3.50 +/-0.05
e	1.75 +/-0.10
f	8.00 +/-0.2
g	φ1.55 +/-0.05

(2) LXES21D series

Dimensions of Tape

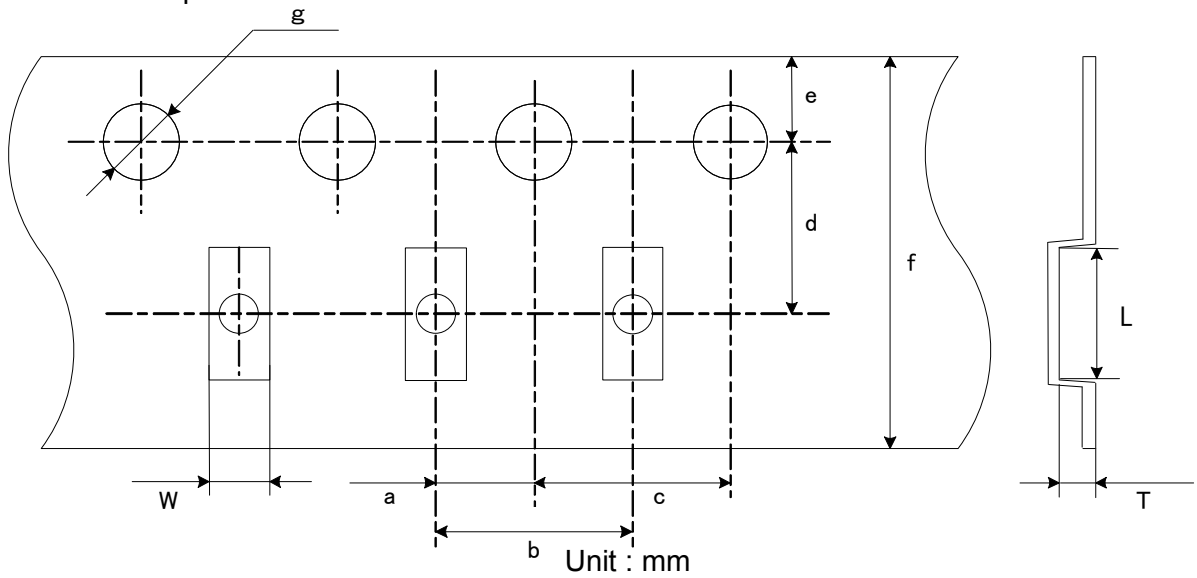

Unit : mm

Mark	Dimension
L	(2.25)
W	(1.45)
T	1.1 max
a	2.00 +/-0.05
b	4.00 +/-0.1

Mark	Dimension
c	4.00 +/-0.1
d	3.50 +/-0.05
e	1.75 +/-0.10
f	8.00 +/-0.2
g	φ1.55 +/-0.05

(3) LXES0ND series
Dimensions of Tape

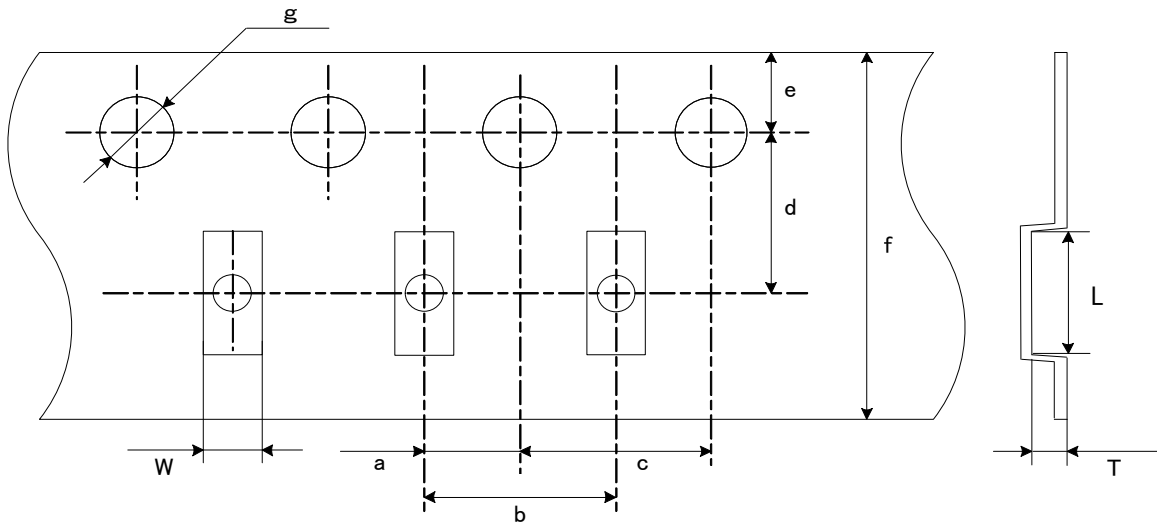

Unit : mm

Mark	Dimension	Mark	Dimension
L	(1.0)	c	4.00 +/-0.1
W	(0.8)	d	3.50 +/-0.05
T	0.64 max	e	1.75 +/-0.10
a	2.00 +/-0.05	f	8.00 +/-0.10
b	2.00 +/-0.1	g	φ1.55 +/-0.05

(4) LXES18D series
Dimensions of Tape

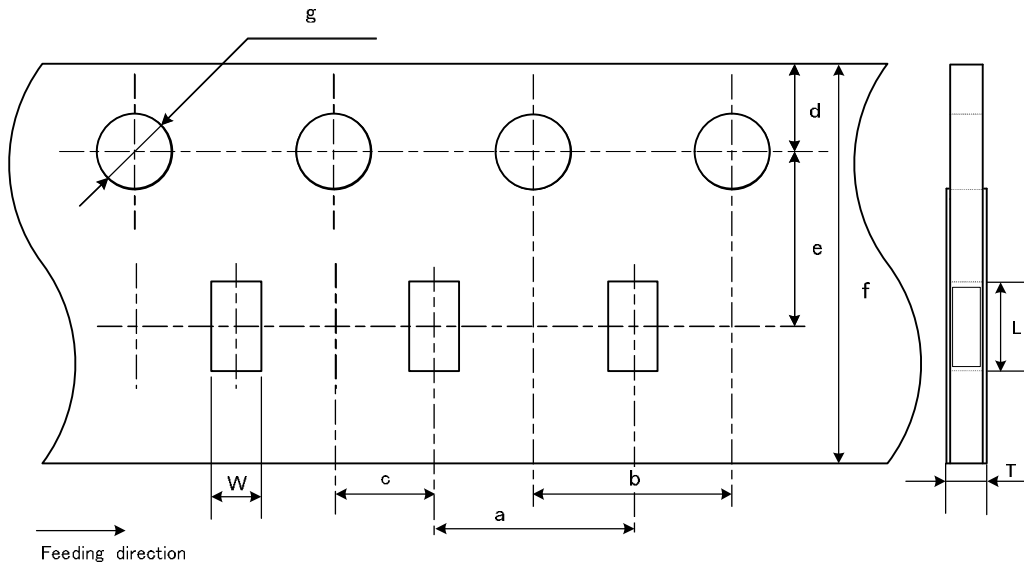

Unit : mm

Mark	Dimension	Mark	Dimension
L	(1.8)	c	2.00 +/-0.05
W	(1.0)	d	1.75 +/-0.1
T	0.64 max	e	3.50 +/-0.05
a	4.00 +/-0.1	f	8.00
b	4.00 +/-0.1	g	φ1.50

(3) Dimensions of Reel

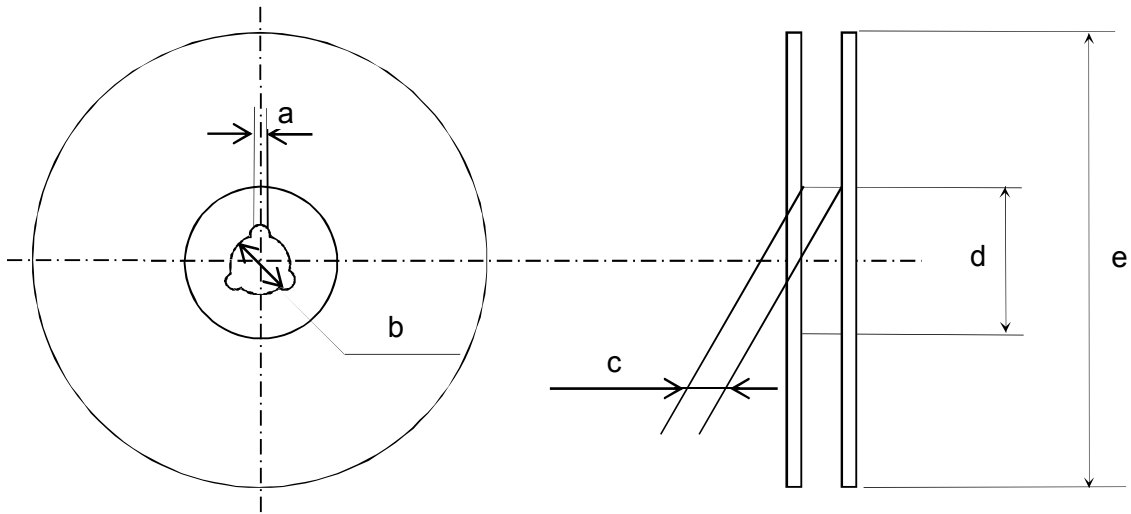

Unit : mm

Symbol	a	b	c	d	e
Dimension	2.0 +/-0.5	φ13.0+/-0.2	9.0+1.0/-0	φ60+1.0/-0	φ180+0/-1.5

(4) Packaging

P/N	pcs / reel
LXES11D series	3,000
LXES21D series	3,000
LXES0ND series	10,000
LXES18D series	4,000

(5) Taping Diagrams

- [1] Feeding Hole : As specified in (1) (2)
- [2] Hole for chip : As specified in (1) (2)
- [3] Cover tape : 50 μ m in thickness
- [4] Base tape : As specified in (1) (2)

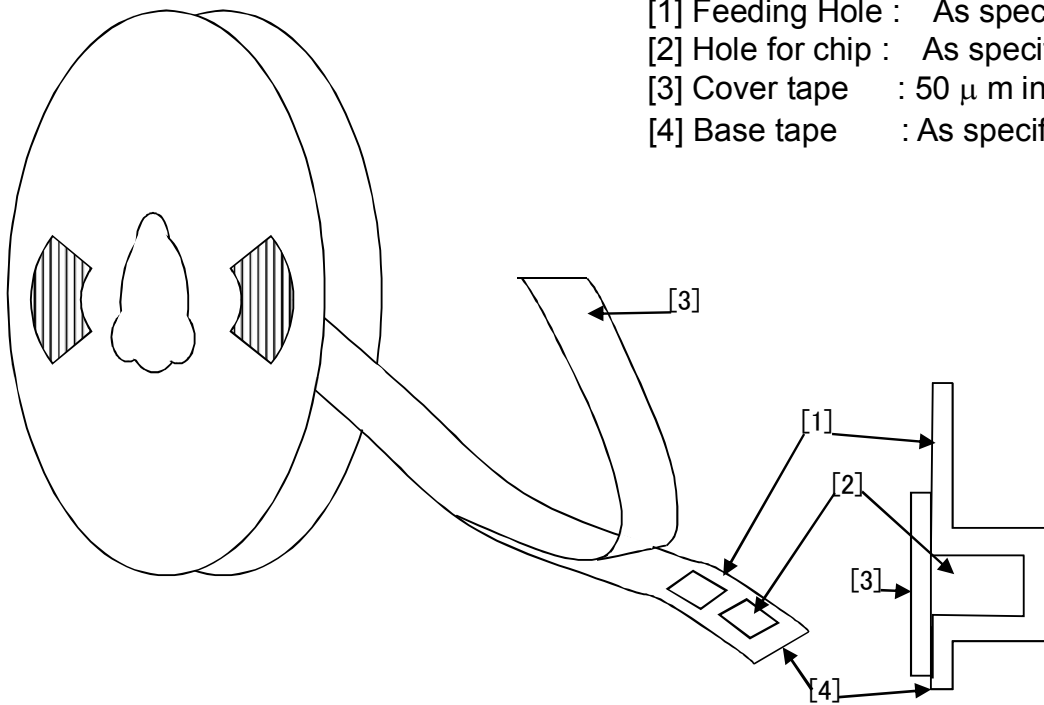

Marking Direction

LXES11D series

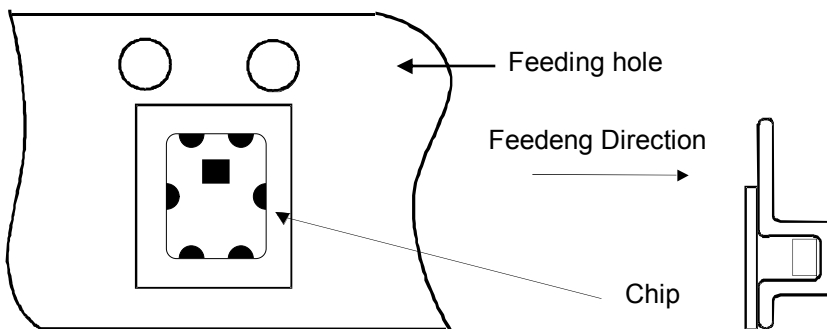

LXES21D series

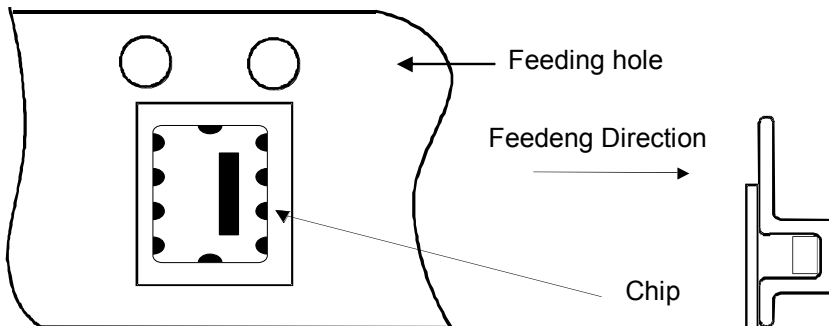

LXES0ND series

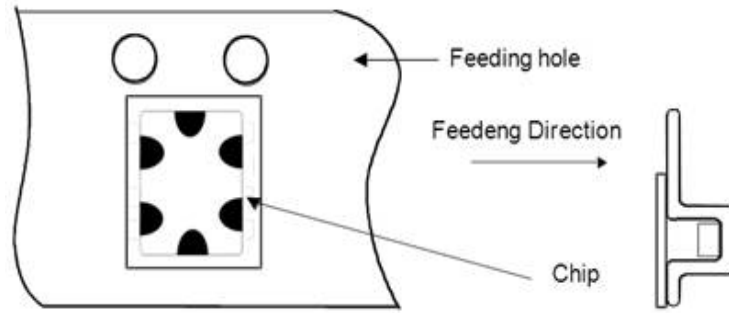

LXES18D series

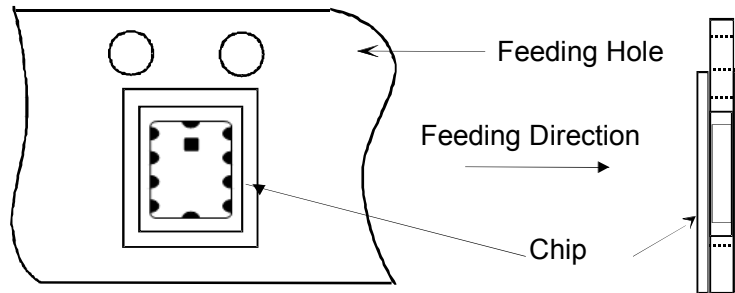

(6) Leader and Tail tape

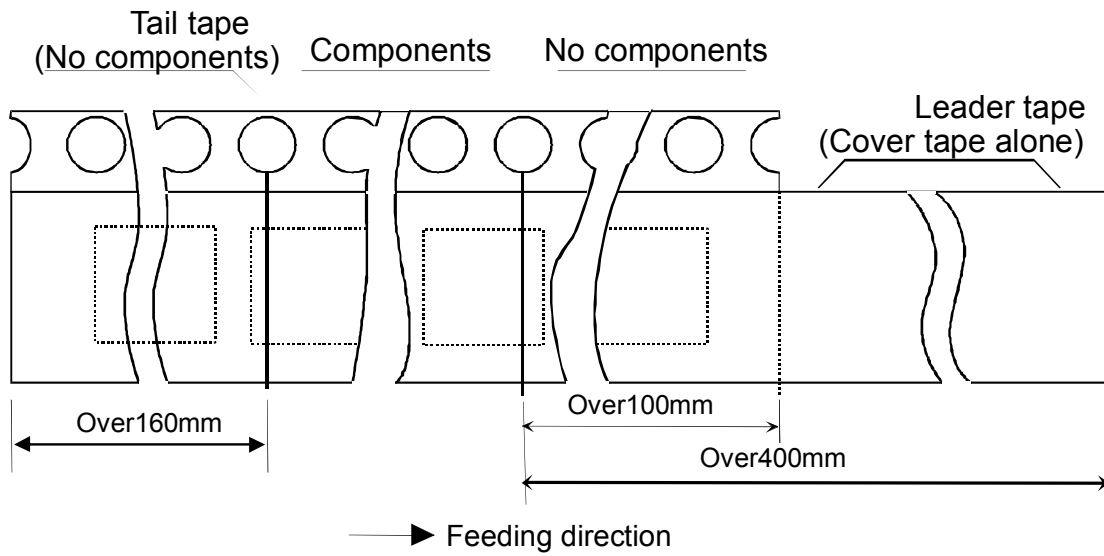

(7) The tape for chips are wound clockwise, the feeding holes to the right side as the tape is pulled toward the user.

- (8) Material : Base tape Plastic(LXES11D series/ LXES21D series)
 Paper(LXES0ND series/ LXES18D series)
 Reel Plastic
 Base tape, Reel and Top tape have an anti-ESD function.

(9) Peeling of force : 0.1~1.0 N in the direction of peeling as shown below.

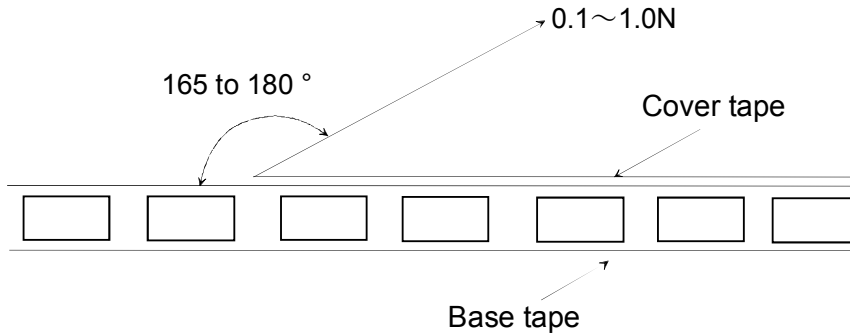

NOTICE

1. Storage Conditions:

To avoid damaging the solderability of the external electrodes, be sure to observe the following points.

- Store products where the ambient temperature is 15 to 35 °C and humidity 45 to 75% RH. (Packing materials, In particular, may be deformed at the temperature over 40 °C.).
- Store products in non corrosive gas (Cl₂, NH₃, SO₂, No_x, etc.).
- Stored products should be used within 6 months of receipt. Solderability should be verified if this period is exceeded.

This product is applicable to MSL1 (Based on IPC/JEDEC J-STD-020)

2. Handling Conditions:

Be careful in handling or transporting products because excessive stress or mechanical shock may break products due to the nature of ceramics structure.

Handle with care if products may have cracks or damages on their terminals, the characteristics of products may change. Do not touch products with bear hands that may result in poor solderability.

3. Standard PCB Design (Land Pattern and Dimensions):

All the ground terminals should be connected to the ground patterns. Furthermore, the ground pattern should be provided between IN and OUT terminals. Please refer to the specifications for the standard land dimensions.

The recommended land pattern and dimensions is as Murata's standard. The characteristics of products may vary depending on the pattern drawing method, grounding method, land dimensions, land forming method of the NC terminals and the PCB material and thickness. Therefore, be sure to verify the characteristics in the actual set. When using non-standard lands, contact Murata beforehand.

4. Notice for Chip Placer:

When placing products on the PCB, products may be stressed and broken by uneven forces from a worn-out chucking locating claw or a suction nozzle. To prevent products from damages, be sure to follow the specifications for the maintenance of the chip placer being used. For the positioning of products on the PCB, be aware that mechanical chucking may damage products.

5. Soldering Conditions:

Carefully perform preheating so that the temperature difference (ΔT) between the solder and products surface should be in the following range. When products are immersed in solvent after mounting, pay special attention to maintain the temperature difference within 100 °C. Soldering must be carried out by the above mentioned conditions to prevent products from damage. Contact Murata before use if concerning other soldering conditions.

Soldering method	Temperature
Soldering iron method	$\Delta T \leq 130 \text{ }^\circ\text{C}$
Reflow method	

- Soldering iron method conditions are indicated below.

Kind of iron Item	Ceramics heater
Soldering iron wattage	$\leq 18 \text{ W}$
Temperature of iron-tip	$\leq 350 \text{ }^\circ\text{C}$
Iron contact time	within 3 sec

- Diameter of iron-tip : $\phi 3.0 \text{ mm max.}$
- Do not allow the iron-tip to directly touch the ceramic element.

Reflow soldering standard conditions(Example)

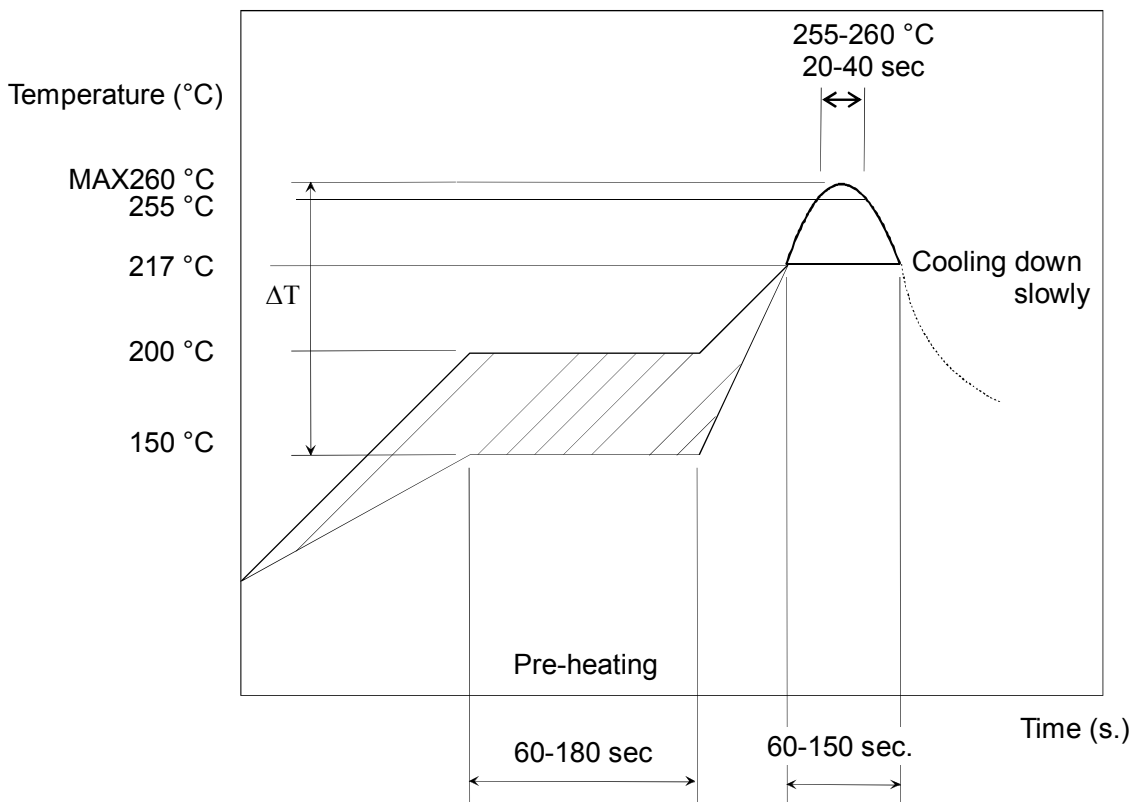

Use rosin type flux or weakly active flux with a chlorine content of 0.2 wt % or less.

Amount of Solder Paste:

- Ensure that solder is applied smoothly to a minimum height of 0.2 to 0.5 mm at the end surface of the external electrodes. If too much or little solder is applied, there is high possibility that the mechanical strength will be insufficient, creating the variation of characteristics.

Amount of solder paste

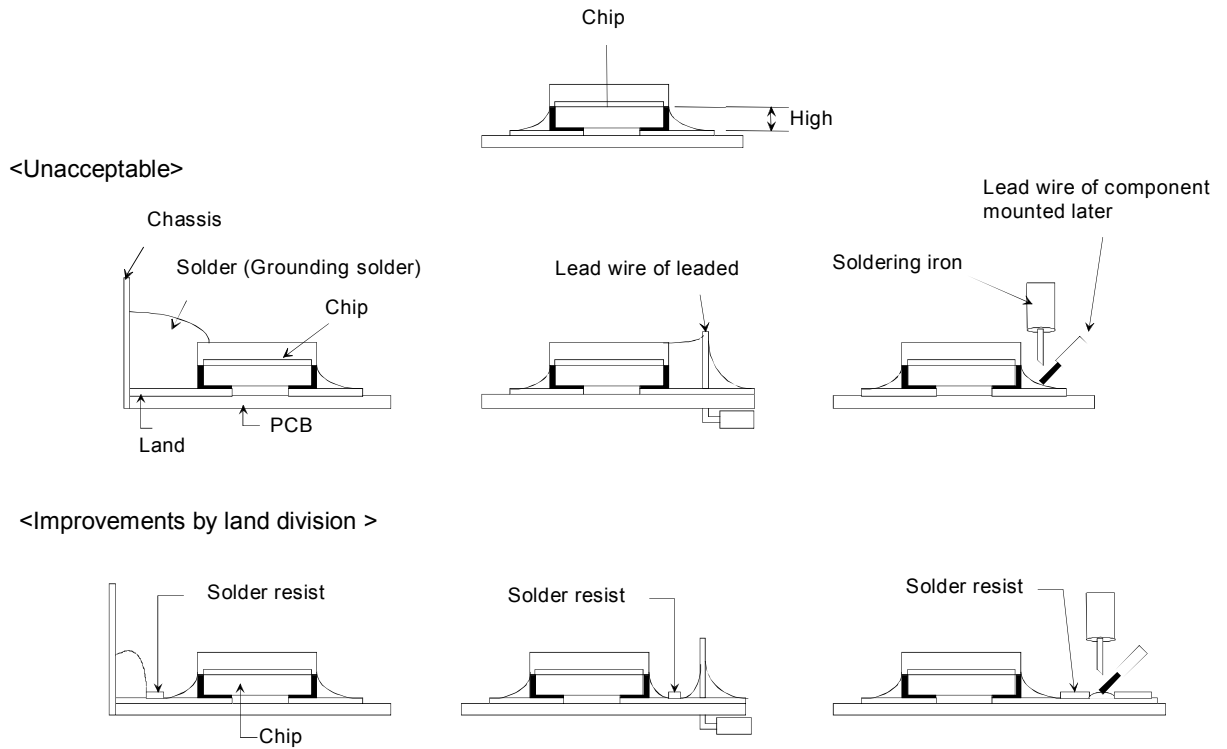

6. Cleaning Conditions:

Any cleaning is not permitted..

7. Operational Environment Conditions:

Products are designed to work for electronic products under normal environmental conditions (ambient temperature, humidity and pressure). Therefore, products have no problems to be used under the similar conditions to the above-mentioned. However, if products are used under the following circumstances, it may damage products and leakage of electricity and abnormal temperature may occur.

- In an atmosphere containing corrosive gas (Cl₂, NH₃, SO_x, NO_x etc.).
- In an atmosphere containing combustible and volatile gases.
- In a dusty environment.
- Direct sunlight
- Water splashing place.
- Humid place where water condenses.
- In a freezing environment.

If there are possibilities for products to be used under the preceding clause, consult with Murata before actual use.

If product malfunctions may result in serious damage, including that to human life, sufficient fail-safe measures must be taken, including the following:

- (1) Installation of protection circuits or other protective device to improve system safety
- (2) Installation of redundant circuits in the case of single-circuit failure

8. Input Current and Voltage Capacity:

Products shall be used in the input current and voltage capacity as specified in this specification. Inform Murata beforehand, in case that the components are used beyond such input current and voltage capacity range.

9. Limitation of Applications:

The products are designed and produced for application in ordinary electronic equipment (AV equipment, OA equipment, telecommunication, etc). If the products are to be used in devices requiring extremely high reliability following the application listed below, you should consult with the Murata staff in advance.

- Aircraft equipment.
- Aerospace equipment
- Undersea equipment.
- Power plant control equipment.
- Medical equipment.
- Transportation equipment (vehicles, trains, ships, etc.).
- Traffic signal equipment.
- Disaster prevention / crime prevention equipment.
- Data-procession equipment.
- Application which malfunction or operational error may endanger human life and property of assets.
- Application which related to occurrence the serious damage
- Application of similar complexity and/ or reliability requirements to the applications listed in the above.



Note:

Please make sure that your product has been evaluated and confirmed against your specifications when our product is mounted to your product.

Product specifications are subject to change or our products in it may be discontinued without advance notice.

This catalog is for reference only and not an official product specification document, therefore, please review and approve our official product specification before ordering this product.

Note:

This catalog is for reference only and not an official product specification document, therefore, please review and approve our official product specification before ordering this product.