

Typical unit

FEATURES

- Regulated Intermediate Bus Architecture (RIBA)
- 95.8% ultra-high efficiency at full load
- 36V-60V DC input range (48V nominal)
- Monotonic startup into pre-bias output conditions
- Over-current & Over-temperature protection
- Synchronous rectifier topology
- Stable no-load operation
- Up to +85° Celsius thermal performance (with derating)
- Remote On/Off enable control
- Fully isolated to 1500VDC
- Extensive protection features- UVLO, OVLO, OC, SC, OT
- Full safety, emissions and environmental certifications
- UL 60950-1, CAN/CSAC22.2 No. 60950-1 IEC60950-1 Certification

Output (V)	Current (A)	Nominal Input (V)
8.0	100	48

Optimized for distributed power Regulated Intermediate Bus Architectures (RIBA), the DRQ-8/100-L48NBxxxx-C series offer regulated outputs in a quarter brick baseplate package.

PRODUCT OVERVIEW

The DRQ-8/100-L48NB-C regulated converter module deliver a 8.0V output @ $V_{in} = 48V_{dc}$ in a quarter brick open frame package at astonishing efficiency. The fully isolated (1500Vdc) DRQ-8/100-L48NBxxxx-C series accept a 36 to 60 Volt DC input voltage range and converts it to a low Vdc output that drives external point-of-load (PoL) DC-DC power converters such as Murata Power Solutions' tiny Okami series which feature precise regulation directly at the load. Applications include datacom and telecom installations, cellular data-phone repeaters, base stations, instruments and embedded systems. Wideband output ripple and noise is a low 100mV, peak-to-peak.

The DRQ's synchronous-rectifier topology and fixed frequency operations means excellent efficiencies up to 95.8 %.

A wealth of electronic protection features include input under voltage lockout, over voltage lockout protection, output current limit, current sharing, short circuit hiccup, Vout overshoot, and over temperature shutdown. Available options include various pin lengths and the baseplate. Assembled using ISO-certified automated surface-mount techniques, the DRQ series is designed to meet all UL and IEC emissions, safety and flammability certifications.

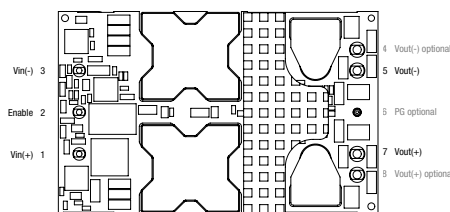

Figure 1a
Bottom View Dual (+/-/-) pin models

A Single Output Pins Version is available where Pin 4 and Pin 8 are removed. The option (A) allows customers to upgrade the power in applications where the Dual Pin would require layout changes. See the specific mechanical drawings and performance data.

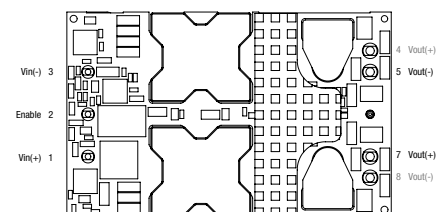

Figure 1b
Bottom View Dual Pins (+/-/-) "Z" models

See the specific mechanical drawings and performance data.



PERFORMANCE SPECIFICATIONS SUMMARY AND ORDERING GUIDE

Root Model ①	Output				Input				Efficiency	Dimensions with baseplate	
	V _{OUT} (V)	I _{OUT} (A, max)	Total Power (W)	Ripple & Noise (mVp-p)	V _{IN} Nom. (V)	Range (V)	I _{IN} , no load (mA)	I _{IN} , full load (A)		Typ.	Case (inches)
	Max.										
DRQ-8/100-L48NB-C	8.0	100	800	150	48	36-60	200	20.8	95.8%	2.3 x 1.45 x 0.57	58.42 x 36.83 x 14.8

① Please refer to the part number structure for additional options and complete ordering part numbers.

② All specifications are at nominal line voltage and full load, +25 °C, unless otherwise noted. See detailed specifications. Cout = 700µF, approximately 50% ceramic, 50% Oscon or POSCAP. I/O caps are necessary for our test equipment and may not be needed for your application.

PART NUMBER STRUCTURE

* NOTE: Refer to the [back page](#) model specific availability

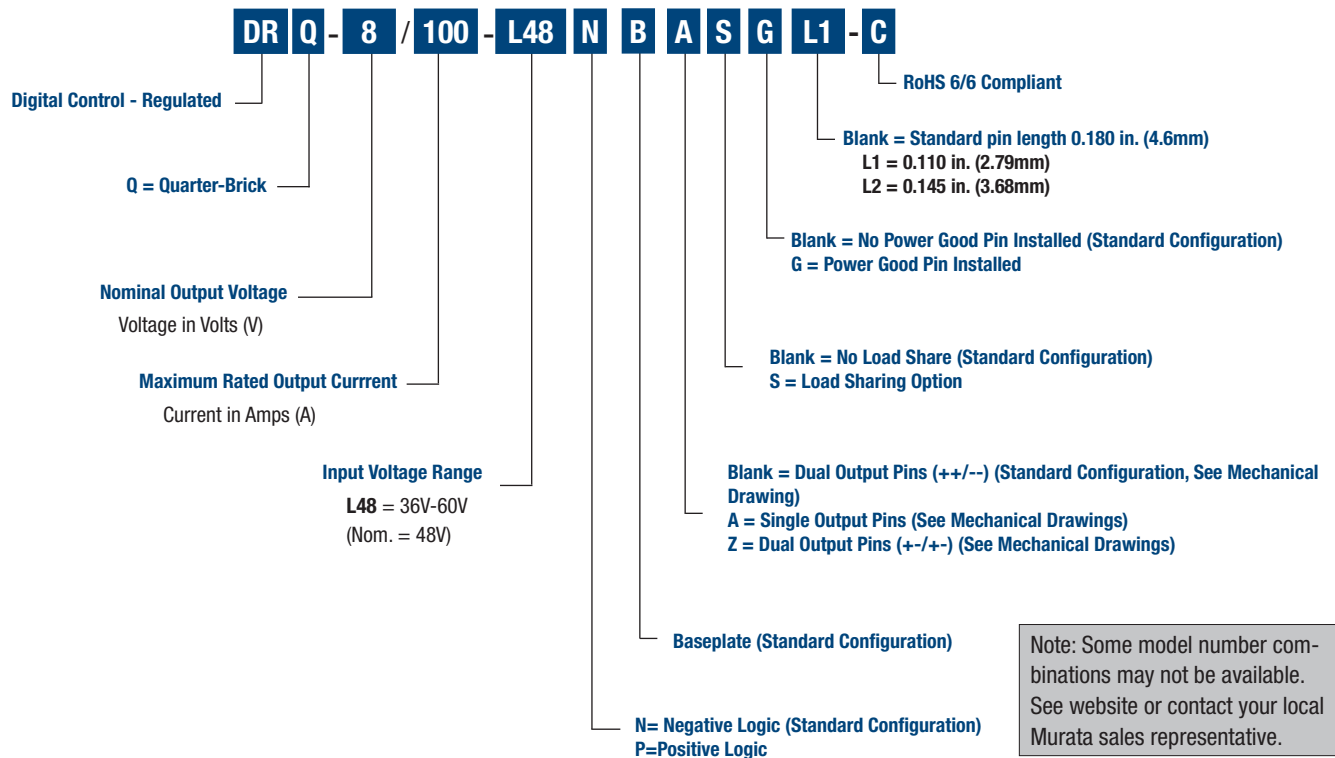

FUNCTIONAL SPECIFICATIONS

ABSOLUTE MAXIMUM RATINGS		Conditions	Minimum	Typical/Nominal	Maximum	Units
Input Voltage, Continuous			36	48	60	Vdc
Input Voltage, Transient		100 mS max. duration			75	Vdc
Isolation Voltage		Input to output	1500			Vdc
On/Off Remote Control		Referred to -Vin			20	Vdc
Output Power			0		800	W
Output Current		Current-limited, no damage, short-circuit protected	0		100	A
Storage Temperature Range		Vin = Zero (no power)	-55		125	°C
Absolute maximums are stress ratings. Exposure of devices to greater than any of these conditions may adversely affect long-term reliability. Proper operation under conditions other than those listed in the Performance/Functional Specifications Table is not implied nor recommended.						
INPUT						
Operating Input Voltage Range			36	48	60	Vdc
Start up Voltage			33.0	34.5	36.0	Vdc
Undervoltage Shutdown			31.0	32.5	34.0	Vdc
UVLO Hysteresis			2.00		4.00	Vdc
Overvoltage Shutdown			78.0	80.0	82.0	Vdc
Overvoltage Shutdown Recover			73.0	75.0	77.0	Vdc
Input OVP Hysteresis			2.00		4.00	Vdc
Internal Filter Type				Pi		
External Input fuse					45	A
External Input Capacitance			140		800	µF
Input current						
Full Load Conditions		Vin = nominal		17.30	20.00	A
Low Line input current		Vin = minimum		23.20	25.00	A
Inrush Current ^⑤					50	% of Iin
Short Circuit input current				0.5		A
No Load input current		Iout = minimum, unit=ON		200	300	mA
Shut-Down input current(Off, UV, OT)				20	50	mA
Back Ripple Current				350	1000	mArms
GENERAL and SAFETY						
Efficiency		Vin=48V, full load	95.0	95.8		%
Isolation Voltage		Input to output	1500			Vdc
		Input to Baseplate	1500			Vdc
		Output to Baseplate	1000			Vdc
Insulation Safety Rating				Operational		
Isolation Resistance				TBD		MΩ
Isolation Capacitance				1000		pF
Safety		Certified to UL-60950-1, CSA-C22.2 No.60950-1; IEC60950-1		Approved		
Calculated MTBF		Per Telcordia SR-332, Issue 2, Method 1, Class 1, Ground Fixed, Tcase=+40°C		1500		Hours x 10 ³
DYNAMIC CHARACTERISTICS						
Switching Frequency				200		KHz
Turn On Time						
Vin Startup Delay		Time from Vin reaching UVLO to Vout reaching 10% of Vout_nominal	20		30	mS
Enable Startup Delay		Time from enable edge to Vout reaching 10% of Vout_nominal			5	mS
Vout Rise Time						
From 0%~100%					15	mS
Dynamic Load Response		50-75-50%, 1A/uS, 4uF/W of external output capacitance, within 1% of Vout			500	µS
Dynamic Load Peak Deviation		same as above			±350	mV
FEATURES and OPTIONS		Conditions	Minimum	Typical/Nominal	Maximum	Units
Remote On/Off Control						
Primary On/Off control (designed to be driving with an open collector logic, Voltages referenced to -Vin)						
"N" suffix:						
Negative Logic, ON state		ON = ground pin or external voltage	-0.1		0.8	Vdc
Negative Logic, OFF state		OFF = pin open or external voltage	2.4		20	Vdc
Control Current		open collector/drain			0.2	mA
"P" suffix:						
Positive Logic, OFF state		OFF = ground pin or external voltage	-0.1		0.8	Vdc
Positive Logic, ON state		ON = pin open or external voltage	2.4		20	Vdc
Control Current :		open collector/drain			0.2	mA

FUNCTIONAL SPECIFICATIONS (CONT.)

OUTPUT	Conditions	Minimum	Typical/Nominal	Maximum	Units
Total Output Power		0	800	800	W
Voltage					
Output Voltage: Standard Option		7.90	8.00	8.10	Vdc
Setting Accuracy	At 0% Load, No Trim, All Conditions	7.97	8.00	8.03	Vdc
Setting Accuracy	At 50% Load, No Trim, All Conditions	7.90	8.00	8.10	Vdc
Setting Accuracy	At 100% Load, No Trim, All Conditions	7.90	8.00	8.10	Vdc
Output Voltage: Load Sharing Option		7.75	8.20	8.65	Vdc
Setting Accuracy	At 0% Load, No Trim, All Conditions	8.38	8.40	8.42	Vdc
Setting Accuracy	At 50% Load, No Trim, All Conditions	7.95	8.20	8.45	Vdc
Setting Accuracy	At 100% Load, No Trim, All Conditions	7.75	8.00	8.25	Vdc
Overvoltage Protection		9.50	10.00	10.50	Vdc
Current					
Output Current Range		0	100	100	A
Minimum Load			No minimum load		
Current Limit Inception	90% of Vout	110		130	A
Short Circuit					
Short Circuit Current	Hiccup technique, autorecovery within 1% of Vout		0.5		A
Short Circuit Duration (remove short for recovery)	Output shorted to ground, no damage		Continuous		
Short circuit protection method	Hiccup current limiting		Non-latching		
Regulation					
Line Regulation	Vin = 36-60, Vout = nom., full load			±0.5	%
Load Regulation (No droop)	Iout = min. to max., Vin = nom.			±0.5	%
Ripple and Noise	20 MHz BW, Cout=700µF, 50% ceramic, 50% OSCON or POSCAP.		100	150	mV pk-pk
Temperature Coefficient (No droop)	At all outputs		0.02		% of Vnom./°C
Output Capacitance		0		10,000	µF
MECHANICAL					
Outline Dimensions (with baseplate)			2.3 x 1.45 x 0.57		Inches
			58.4 x 36.83 x 14.8		mm
Weight (with baseplate)			3.14		Ounces
			80		Grams
Through Hole Pin Diameter			0.06 & 0.04		Inches
			1.524 & 1.016		mm
Through Hole Pin Material			Copper alloy		
TH Pin Plating Metal and Thickness	Nickel subplate		98.4-299		µ-inches
	Gold overplate		4.7-19.6		µ-inches
ENVIRONMENTAL					
Operating Ambient Temperature Range	with derating	-40		85	°C
Operating Baseplate Temperature		-40		115	°C
Storage Temperature	Vin = Zero (no power)	-55		125	°C
Thermal Protection/Shutdown (with "B" Suffix)	Case temperature, measured in the center		130		°C
Electromagnetic Interference Conducted, EN55022/CISPR22	External filter required; see emissions performance test.		B		Class
RoHS rating			RoHS-6		

Notes

- ① Unless otherwise noted, all specifications apply over the input voltage range, full temperature range, nominal output voltage and full output load. General conditions are near sea level altitude, heat sink installed and natural convection airflow unless otherwise specified. All models are tested and specified with external parallel 1 µF and 10 µF multi-layer ceramic output capacitors. No external input capacitor is used (see Application Notes). All capacitors are low-ESR types wired close to the converter. These capacitors are necessary for our test equipment and may not be needed in the user's application.
- ② Measured at input pin with maximum specified Cin and <500µH inductance between voltage source and Cin
- ③ All models are stable and regulate to specification under no load.
- ④ The Remote On/Off Control is referred to -Vin.
- ⑤ Inrush Current is defined as the peak current drawn by the Unit when Unit is enabled after Vin is present. Iin is defined as the steady-state operating current when Unit is operating at Vin Max and Rated Power. While Vout is rising, Pout is ≤25% of Rated Power with a resistive load.

FUNCTIONAL SPECIFICATIONS (CONT.)

POWER GOOD	Notes	Minimum	Typical/Nominal	Maximum	Units
Output Voltage Low (trigger limits)	1	8.2	-	8.6	V
Output Voltage High (trigger limits)	1	12.6	-	13.1	V
Input Voltage Low (trigger limits) Rising	6	42.5	-	45	V
Input Voltage High (trigger limits) Rising	6	58	-	61	V
Hysteresis	-	1	-	-	V
High State Voltage	1	0	-	5.5	V
High State Leakage Current (into Pin)	1	0	-	10	μA
Low State Voltage	1	0	-	0.8	V
Low State Current (into Pin)	1	0	-	5	mA
Power Good Signal De-assert Response Time	2, 5	0	-	3	ms
Power Good Signal Assert Response Time	3, 5	0	-	3	ms
Power Good Signal Duration	4	200	-	600	ms

Notes

- ① Power-Good signal is referenced to Vout(-). If output voltage is lower than "Output Voltage Low" or higher than "Output Voltage High," PG will be set to BAD.
- ② Power-Good Signal De-assert Response Time is defined as the duration between the fault occurring and the Power-Good Signal de-asserting.
- ③ Power-Good Signal Assert Response Time is defined as the duration between unit powering up with no faults and the Power Good Signal asserting.
- ④ Power-Good Signal Duration is defined as the duration the Power-Good signal must stay de-asserted if a transient fault occurs.
- ⑤ Power-Good assertion & de-assertion must be deglitched to avoid false triggering.
- ⑥ PGood signal should indicate Good when Vin is within operating range and indicate bad before unit is shut-down due to UV or OV.

PERFORMANCE DATA

Efficiency vs. Line Voltage and Load Current @ +25°C

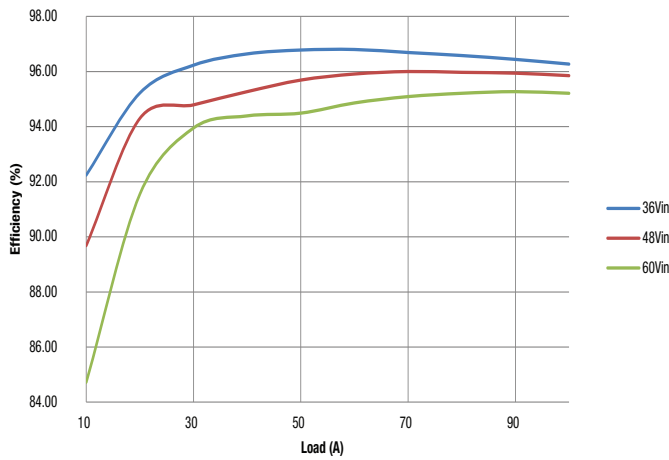

Power Loss vs. Line Voltage and Load Current @ +25°C

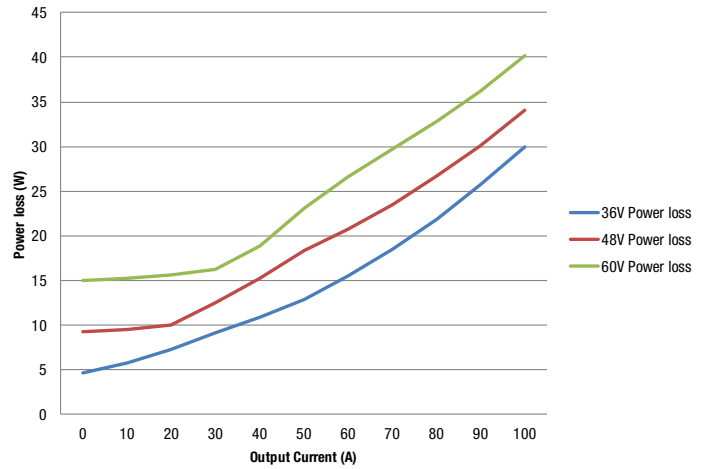

Dual Output Pins Maximum Current Temperature Derating at sea level (Vin = 48V, airflow from Vin to Vout, with heatsink)*

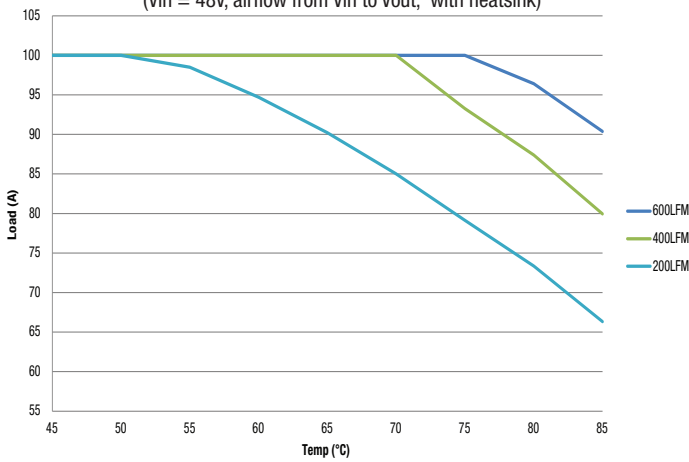

Single Output Pins Maximum Current Temperature Derating at sea level (Vin = 48V, airflow from Vin to Vout, with heatsink)*

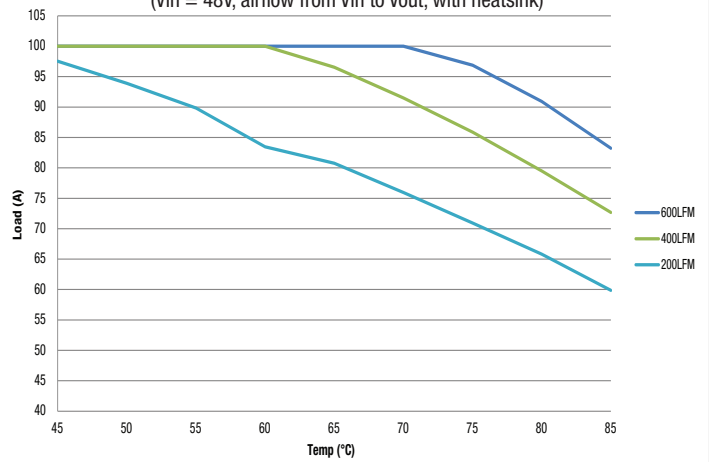

Dual Output Pins Maximum Output Power Temperature Derating at sea level (Vin = 48V, airflow from Vin to Vout, with heatsink)*

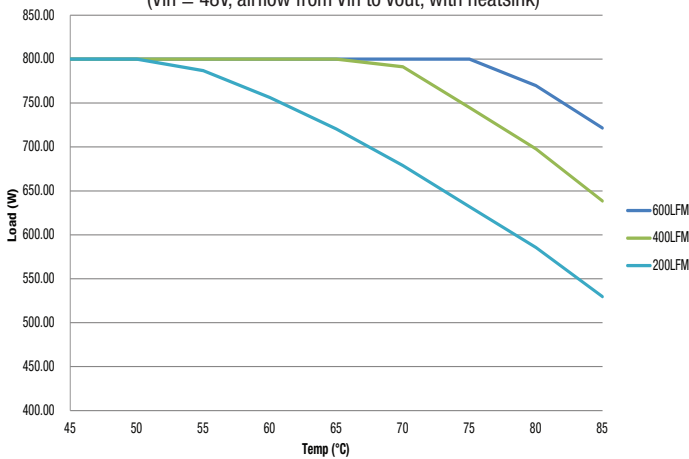

Single Output Pins Maximum Output Power Temperature Derating at sea level (Vin = 48V, airflow from Vin to Vout, with heatsink)*

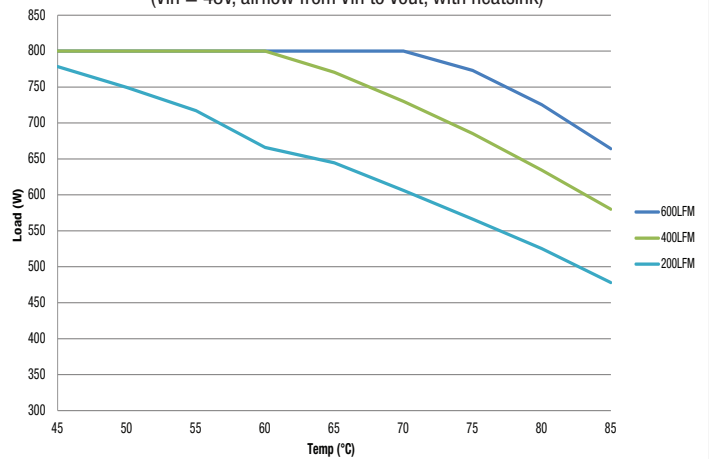

See Page 8 for heatsink information.

NOTE: The heatsink is not available as an option. It is only used in the thermal testing of this device.

MECHANICAL SPECIFICATIONS (THROUGH-HOLE MOUNT)

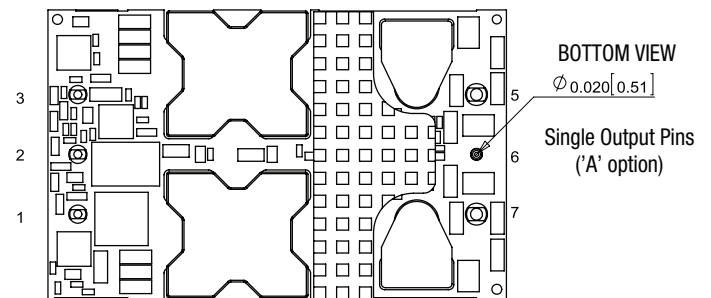
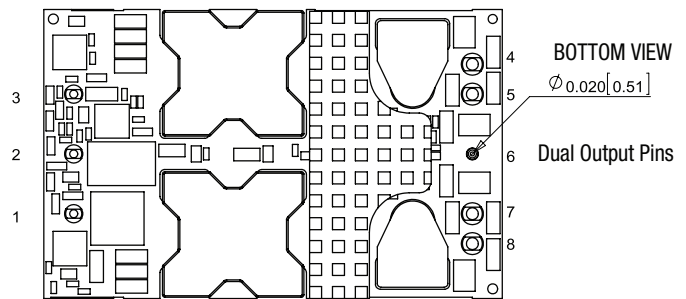
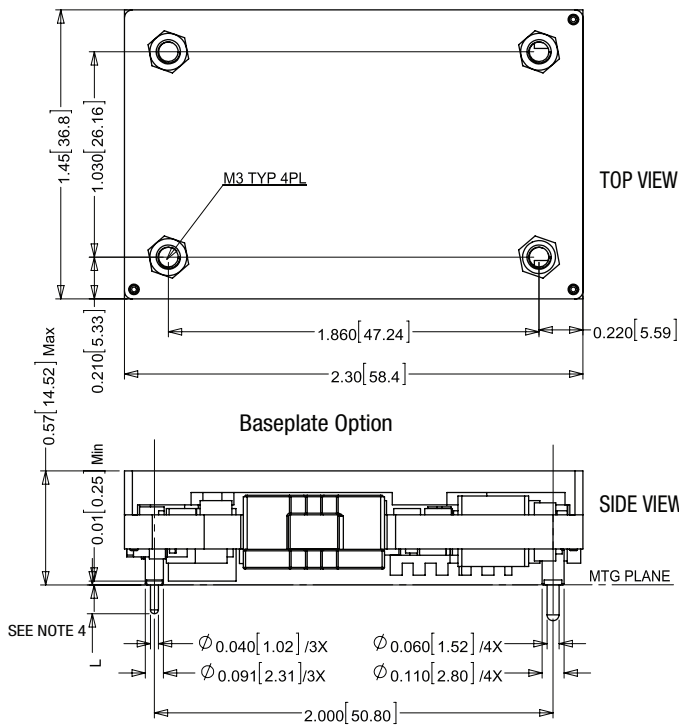

INPUT/OUTPUT CONNECTIONS

PIN	FUNCTION	PIN	FUNCTION
1	Vin(+)	5	Vout(-)
2	Enable	6	PG*
3	Vin(-)	7	Vout(+)
4	Vout(-)*	8	Vout(+)*

Dimensions are in inches (mm shown for ref. only).

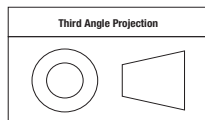

Tolerances (unless otherwise specified):
 .XX ± 0.02 (0.5)
 .XXX ± 0.010 (0.25)
 Angles ± 2°

Components are shown for reference only and may vary between units.

Pin Material
 Pin No. 1-3: Dia 0.04", Copper Alloy
 Pin No. 4, 5, 7, 8: Dia 0.06", Copper Alloy
 Pin No. 6: Dia 0.02", Copper Alloy
 Finish: (All Pins)
 Gold (5u"Min) OverNickel(100u"Min)

- NOTES:**
 UNLESS OTHERWISE SPECIFIED;
 1:M3 SCREW USED TO BOLT UNIT'S BASEPLATE TO OTHER SURFACES(SUCH AS HEATSINK) MUST NOT EXCEED 0.110"(2.8mm) DEPTH BELOW THE SURFACE OF BASEPLATE
 2:APPLIED TORQUE PER SCREW SHOULD NOT EXCEED 5.3In-lb(0.6Nm);
 3:ALL DIMENSION ARE IN INCHES[MILIMETER];
 4:STANDARD PIN LENGTH: 0.180 Inch
 FOR L2 PIN LENGTH OPTION IN MODEL NAME., USE STANDARD L2 PIN WITH PIN LENGTH TO 0.145 Inch
 6:ALL TOLERANCES: x.xx in, ±0.02 in(x.x mm, ±0.5 mm)
 x.xxx in, ±0.01 in(x.x mm, ±0.25 mm)
 7:COMPONENT WILL VARY BETWEEN MODELS

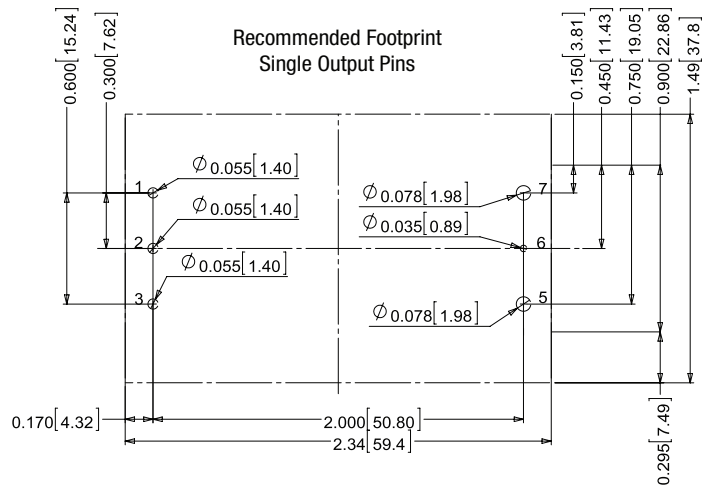
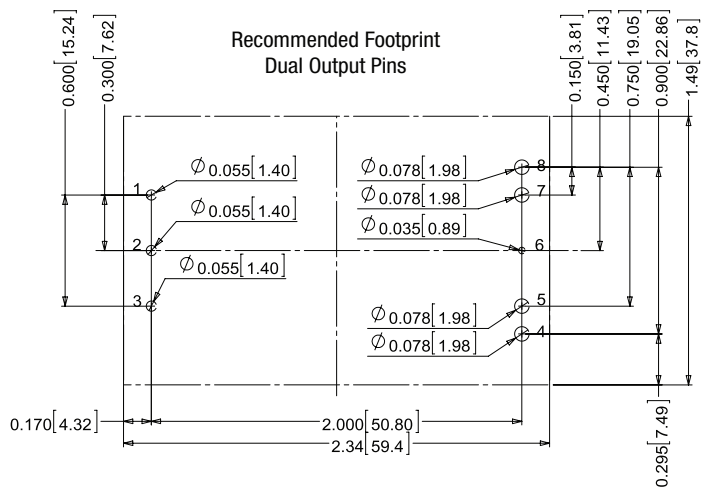

MECHANICAL SPECIFICATIONS (THROUGH-HOLE MOUNT)

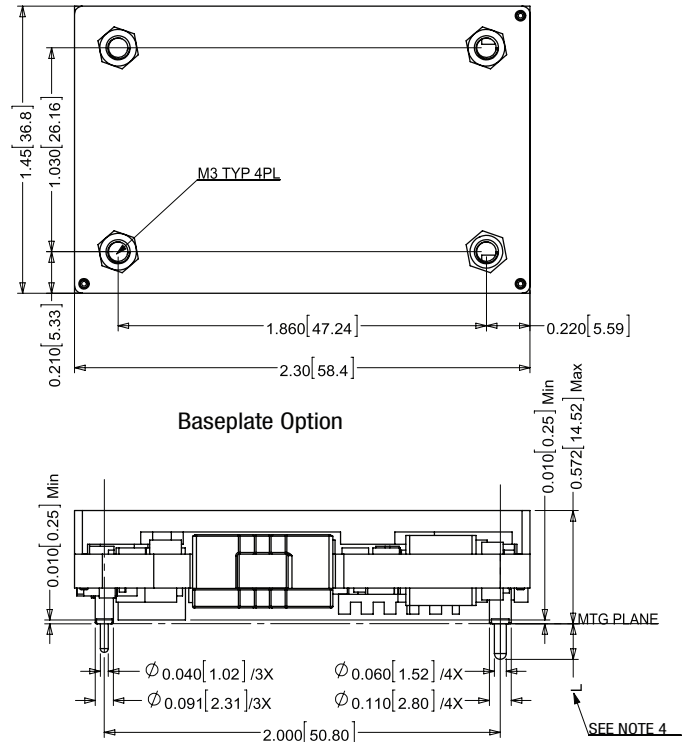
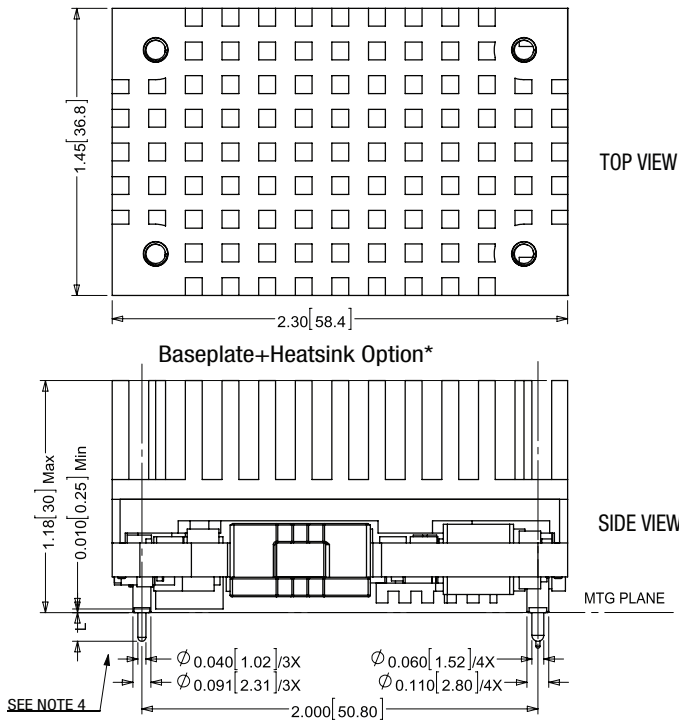

BOTTOM VIEW

- NOTES:
UNLESS OTHERWISE SPECIFIED;
1:M3 SCREW USED TO BOLT UNIT'S BASEPLATE TO OTHER SURFACES(SUCH AS HEATSINK) MUST NOT EXCEED 0.110"(2.8mm) DEPTH BELOW THE SURFACE OF BASEPLATE
2:APPLIED TORQUE PER SCREW SHOULD NOT EXCEED 5.31n-lb(0.6Nm);
3:ALL DIMENSION ARE IN INCHES[MILIMETER];
4:STANDARD PIN LENGTH: 0.180 Inch
FOR L2 PIN LENGTH OPTION IN MODEL NAME., USE STANDARD L2 PIN WITH PIN LENGTH TO 0.145 Inch
5:ALL TOLERANCES: x.xx.in ,±0.02in(x.xmm,±0.5mm)
x.xxx.in ,±0.01in(x.xmm,±0.25mm)
6:COMPONENT WILL VARY BETWEEN MODELS
*NOTE THE HEATSINK IS NOT AVAILABLE AS AN OPTION,IT IS ONLY USED IN THE THERMAL TEST OF THIS DEVICE.

INPUT/OUTPUT CONNECTIONS			
PIN	FUNCTION	PIN	FUNCTION
1	Vin(+)	5	Vout(-)
2	Enable	6	PG*
3	Vin(-)	7	Vout(+)
4	Vout(-)*	8	Vout(+)*

* These pins are optional. Please refer to the part number structure.
Dimensions are in inches (mm shown for ref. only).

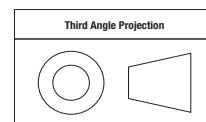

Tolerances (unless otherwise specified):
.XX ± 0.02 (0.5)
.XXX ± 0.010 (0.25)
Angles ± 2°

Components are shown for reference only and may vary between units.

SHIPPING TRAYS AND BOXES, THROUGH-HOLE MOUNT

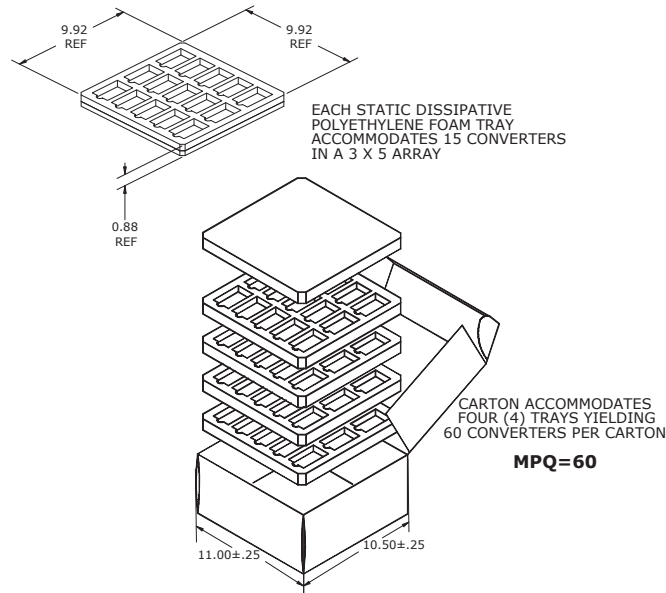

SHIPPING TRAY DIMENSIONS

DRQ modules are supplied in a 15-piece (5 x 3) shipping tray. The tray is an anti-static closed-cell polyethylene foam. Dimensions are shown below.

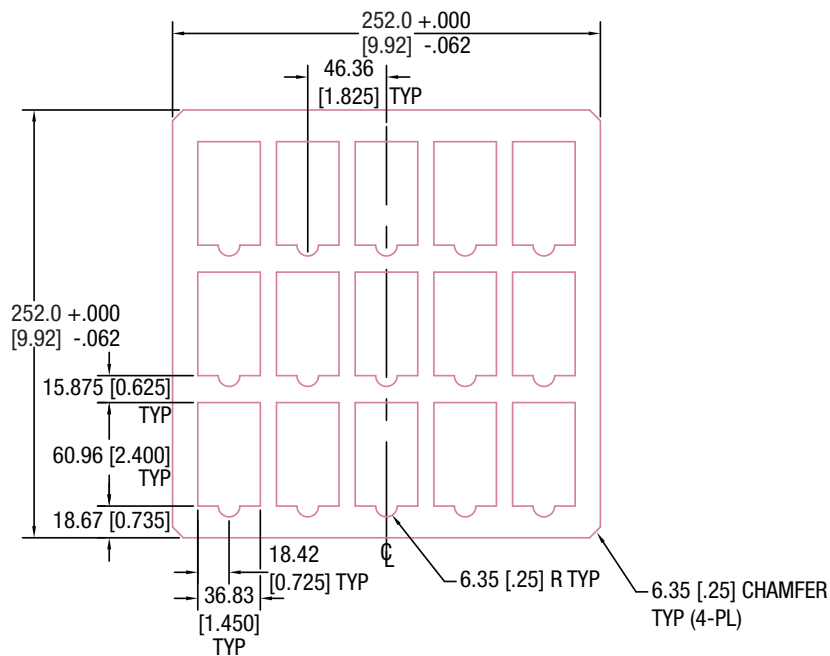

Notes:

1. Material: Dow 220 antistat ethafoam (Density: 34-35 kg/m³)
2. Dimensions: 252 x 252 x 19.1 mm 5 x 3 array (15 per tray)
3. All dimensions in millimeters [inches]
4. Tolerances unless otherwise specified: +1/-0

TECHNICAL NOTES

Load Sharing

Load sharing occurs when two or more DRQ-8/100-L48NB-Cs are connected in parallel at both the input and output terminals to supply greater output current than one unit alone or to offer system redundancy for moderate loads. If one converter fails, the other converter(s) will carry the load until the system is repaired.

The DRQ-8/100-L48NB-C's design allows load sharing using the "droop" method, also called the "direct connect" technique. Simply put, at light loads, the converter with slightly higher output voltage will carry more of the output current. Since the DRQ-8/100-L48NB-C's synchronous rectifier design will not accept appreciable reverse output current, starting at zero load, the DRQ-8/100-L48NB-C with the higher output voltage will carry more of the full load until the voltage at the output drops to that of the lower DRQ-8/100-L48NB-C's.

Load Sharing Guidelines

If you wish to operate two or more DRQ-8/100-L48NB-C's in load sharing, use these guidelines:

[1] Operate both converters connected in parallel to the same 48V input power source. This simplifies the design and makes more balanced power sharing. Using two different 48V input supplies must be carefully analyzed to avoid overloading one of the converters and is not recommended.

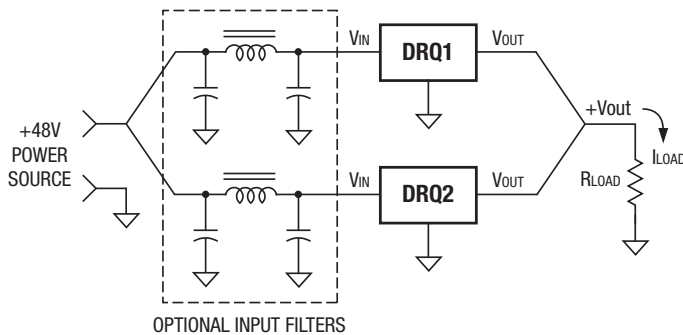

Figure 2. Load Sharing Block Diagram

Make sure the single 48V input source can supply the total current needed by all the parallel-connected DRQ-8/100-L48NB-C's. (Actually, it is possible to rate the full system at more than the current capacity of a single DRQ-8/100-L48NB-C. However, you now lose the redundancy protection feature.)

[2] Use conservative loading. Do not assume for example that two parallel DRQ-8/100-L48NB-C's can always supply "times two" amounts of output current. Allow for limits in input voltage and other factors.

If one DRQ-8/100-L48NB-C overloads while in load share, it will protect itself by entering the overcurrent mode. If the whole system is running close to maximum output current, the remaining good DRQ-8/100-L48NB-C will soon also enter overcurrent mode. These two events probably will not happen together, possibly leaving the system operating in degraded mode for awhile. The solution here is conservative design to avoid getting close to the load limits.

[3] Make the input wiring lengths and wire gauges identical on both inputs and outputs. If in doubt, make some precision measurements under full load.

But if you attempt to measure the current in one of the converters using a series shunt, remember that the current meter itself may introduce enough finite resistance to affect the readings. (Hint: Use a non-contacting "clamp-on" Hall effect DC current meter with zero IR loss.)

[4] If you add the optional input filters, use identical components with the same layout.

[5] Operate both converters in the same temperature and airflow environment. Under load sharing, small differences in cooling can amplify into load imbalances.

[6] Avoid operation near the low input voltage limit of the converter. Another subtle factor here is the external source impedance of the input supply. A source with higher source impedance at full load may make the net input voltage seen by the converter close to its minimum input voltage. Be sure to account for the decrease in effective input voltage under load.

For battery sources, this means that the batteries should be freshly charged and that the AC trickle charger is in good working order. Note that older batteries increase their internal cell impedance even if their no-load output voltage appears acceptable. Remember that what counts here is the voltage seen at the DRQ-8/100-L48NB-C input connections with full current.

[7] As with any system design, thoroughly test the DRQ-8/100-L48NB-C's connected in load sharing before committing the design to a real application.

CAUTION – This converter is not internally fused. To avoid danger to persons or equipment and to retain safety certification, the user must connect an external fast-blow input fuse as listed in the specifications. Be sure that the PC board pad area and etch size are adequate to provide enough current so that the fuse will blow with an overload.

Power-Good Signal

The Power Good signal is a non-latching open-collector output that is Low during normal operation and is pulled High by an internal 3.3V rail through a 5.1k resistor when any of the following conditions occur:

- Over-Temperature
- Over-Current
- Vout is outside of the DC Output Band while Vin is within the Vin Operating Range
- Vin is within the Vin Operating Range but the unit is not operating (to determine if one Unit used in a parallel configuration is not operating)
- Vin is outside of the Vin Operating Range

Start Up Considerations

When power is first applied to the DC/DC converter, there is some risk of start up difficulties if you do not have both low AC and DC impedance and adequate regulation of the input source. Make sure that your source supply does not allow the instantaneous input voltage to go below the minimum voltage at all times.

Use a moderate size capacitor very close to the input terminals. You may need two or more parallel capacitors. A larger electrolytic or ceramic cap supplies the surge current and a smaller parallel low-ESR ceramic cap gives low AC impedance.

Remember that the input current is carried both by the wiring and the ground plane return. Make sure the ground plane uses adequate thickness copper. Run additional bus wire if necessary.

On/Off Control

The input-side, remote On/Off Control function (pin 2) can be ordered to operate with either logic type:

Negative (“N” suffix): Negative-logic devices are off when pin 2 is left open (or pulled high, applying +2.4V to 20V), and on when pin 2 is pulled low (-0.1V to 0.8V) with respect to -Input as shown in Figure 3.

Positive (“P” suffix): Positive-logic devices are on when pin 2 is left open (or pulled high, applying +2.4V to +20V), and off when pin 2 is pulled low (-0.1V to 0.8V) with respect to -Input as shown in Figure 3.

possibility of sustained input voltage reversal which is not current-limited. For greatest safety, we recommend a fast blow fuse installed in the ungrounded input supply line.

Input Under-Voltage Shutdown and Start-Up Threshold

Under normal start-up conditions, converters will not begin to regulate properly until the rising input voltage exceeds and remains at the Start-Up Threshold Voltage (see Specifications). Once operating, converters will not turn off until the input voltage drops below the Under-Voltage Shutdown Limit. Subsequent restart will not occur until the input voltage rises again above the Start-Up Threshold. This built-in hysteresis prevents any unstable on/off operation at a single input voltage.

Start-Up Time

Assuming that the output current is set at the rated maximum, the Vin to Vout Start-Up Time (see Specifications) is the time interval between the point when the rising input voltage crosses the Start-Up Threshold and the fully loaded output voltage enters and remains within its specified accuracy band. Actual measured times will vary with input source impedance, external input capacitance, input voltage slew rate and final value of the input voltage as it appears at the converter.

These converters include a soft start circuit to moderate the duty cycle of its PWM controller at power up, thereby limiting the input inrush current.

The On/Off Remote Control interval from On command to Vout (final $\pm 5\%$) assumes that the converter already has its input voltage stabilized above the Start-Up Threshold before the On command. The interval is measured from the On command until the output enters and remains within its specified accuracy band. The specification assumes that the output is fully loaded at maximum rated current. Similar conditions apply to the On to Vout regulated specification such as external load capacitance and soft start circuitry.

Recommended Input Filtering

The user must assure that the input source has low AC impedance to provide dynamic stability and that the input supply has little or no inductive content, including long distributed wiring to a remote power supply. The converter will operate with no additional external capacitance if these conditions are met.

For best performance, we recommend installing a low-ESR capacitor immediately adjacent to the converter’s input terminals. The capacitor should be a ceramic type such as the Murata GRM32 series or a polymer type. Make sure that the input terminals do not go below the undervoltage shutdown voltage at all times. More input bulk capacitance may be added in parallel (either electrolytic or tantalum) if needed.

Recommended Output Filtering

The converter will achieve its rated output ripple and noise with no additional external capacitor. However, the user may install more external output capacitance to reduce the ripple even further or for improved dynamic response. Again, use low-ESR ceramic (Murata GRM32 series) or polymer capacitors. Mount these close to the converter. Measure the output ripple under your load conditions.

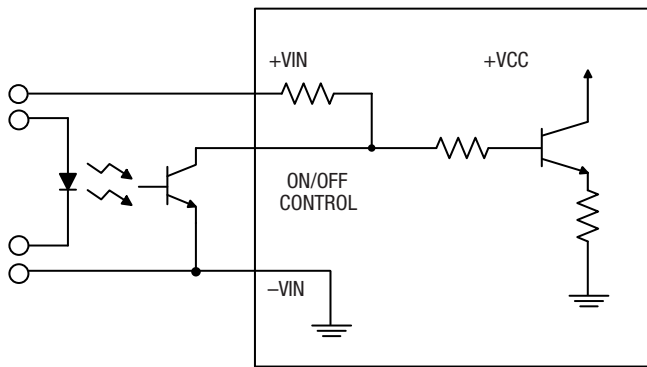

Figure 3. Driving the Negative Logic On/Off Control Pin

Dynamic control of the remote on/off function is best accomplished with a mechanical relay or an open-collector/open-drain drive circuit (optically isolated if appropriate). The drive circuit should be able to sink appropriate current (see Performance Specifications) when activated and withstand appropriate voltage when deactivated. Applying an external voltage to pin 2 when no input power is applied to the converter can cause permanent damage to the converter.

Input Fusing

Certain applications and/or safety agencies may require fuses at the inputs of power conversion components. Fuses should also be used when there is the

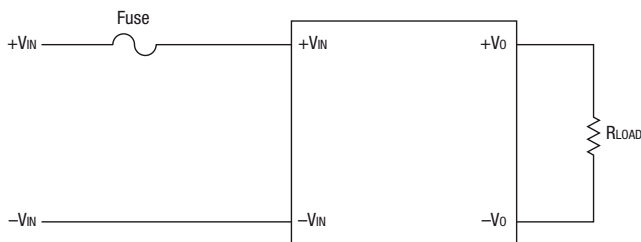

Figure 4. Input Fusing

Use only as much capacitance as required to achieve your ripple and noise objectives. Excessive capacitance can make step load recovery sluggish or possibly introduce instability. Do not exceed the maximum rated output capacitance listed in the specifications.

Input Ripple Current and Output Noise

All models in this converter series are tested and specified for input reflected ripple current and output noise using designated external input/output components, circuits and layout as shown in the figures below. The Cbus and Lbus components simulate a typical DC voltage bus.

Minimum Output Loading Requirements

All models regulate within specification and are stable under no load to full load conditions. Operation under no load might however slightly increase output ripple and noise.

Thermal Shutdown

To prevent many over temperature problems and damage, these converters include thermal shutdown circuitry. If environmental conditions cause the temperature of the DC/DC's to rise above the Operating Temperature Range up to the shutdown temperature, an on-board electronic temperature sensor will power down the unit. When the temperature decreases below the turn-on threshold, the converter will automatically restart. There is a small amount of hysteresis to prevent rapid on/off cycling.

CAUTION: If you operate too close to the thermal limits, the converter may shut down suddenly without warning. Be sure to thoroughly test your application to avoid unplanned thermal shutdown.

Temperature Derating Curves

The graphs in this data sheet illustrate typical operation under a variety of conditions. The Derating curves show the maximum continuous ambient air temperature and decreasing maximum output current which is acceptable under increasing forced airflow measured in Linear Feet per Minute ("LFM").

Note that these are AVERAGE measurements. The converter will accept brief increases in current or reduced airflow as long as the average is not exceeded.

Note that the temperatures are of the ambient airflow, not the converter itself which is obviously running at higher temperature than the outside air.

Murata Power Solutions makes Characterization measurements in a closed cycle wind tunnel with calibrated airflow. We use both thermocouples and an infrared camera system to observe thermal performance. As a practical matter, it is quite difficult to insert an anemometer to precisely measure airflow in most applications. Sometimes it is possible to estimate the effective airflow if you thoroughly understand the enclosure geometry, entry/exit orifice areas and the fan flowrate specifications.

CAUTION: If you exceed these Derating guidelines, the converter may have an unplanned Over Temperature shut down. Also, these graphs are all collected near Sea Level altitude. Be sure to reduce the derating for higher altitude.

Output Fusing

The converter is extensively protected against current, voltage and temperature extremes. However your output application circuit may need additional protection. In the extremely unlikely event of output circuit failure, excessive voltage could be applied to your circuit. Consider using an appropriate fuse in series with the output.

Output Current Limiting

Current limiting inception is defined as the point at which full power falls below the rated tolerance. See the Performance/Functional Specifications. Note particularly that the output current may briefly rise above its rated value in normal operation as long as the average output power is not exceeded. This enhances reliability and continued operation of your application. If the output current is too high, the converter will enter the short circuit condition.

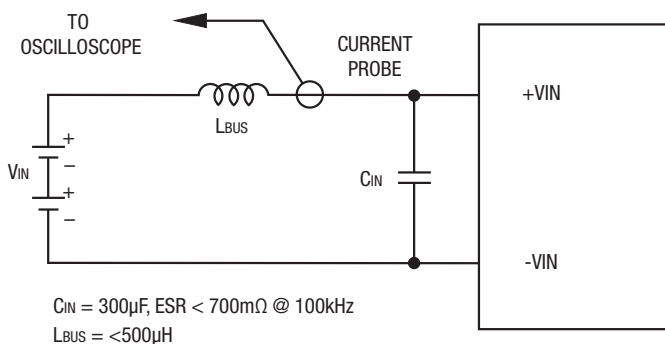

Figure 5. Measuring Input Ripple Current

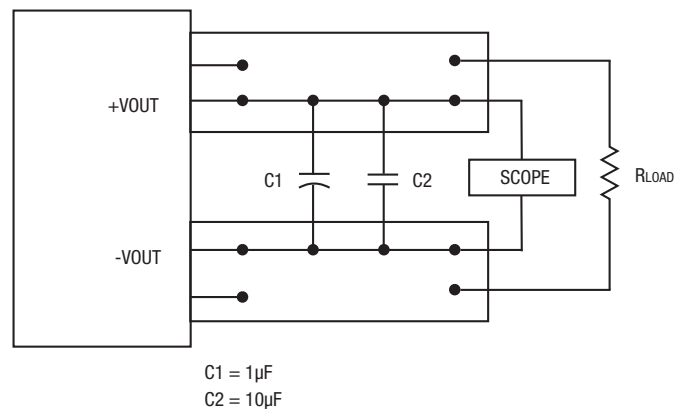

Figure 6. Measuring Output Ripple and Noise (PARD)

Output Short Circuit Condition

When a converter is in current-limit mode, the output voltage will drop as the output current demand increases. If the output voltage drops too low (approximately 97% of nominal output voltage for most models), the PWM controller will shut down. Following a time-out period, the PWM will restart, causing the output voltage to begin rising to its appropriate value. If the short-circuit condition persists, another shutdown cycle will initiate. This rapid on/off cycling is called “hiccup mode.” The hiccup cycling reduces the average output current, thereby preventing excessive internal temperatures and/or component damage.

The “hiccup” system differs from older latching short circuit systems because you do not have to power down the converter to make it restart. The system will automatically restore operation as soon as the short circuit condition is removed.

Output Capacitive Load

These converters do not require external capacitance added to achieve rated specifications. Users should only consider adding capacitance to reduce switching noise and/or to handle spike current load steps. Install only enough capacitance to achieve noise objectives. Excess external capacitance may cause degraded transient response and possible oscillation or instability.

NOTICE—Please use only this customer data sheet as product documentation when laying out your printed circuit boards and applying this product into your application. Do NOT use other materials as official documentation such as advertisements, product announcements, or website graphics.

We strive to have all technical data in this customer data sheet highly accurate and complete. This customer data sheet is revision-controlled and dated. The latest customer data sheet revision is normally on our website (www.murata-ps.com) for products which are fully released to Manufacturing. Please be especially careful using any data sheets labeled “Preliminary” since data may change without notice.

Emissions Performance, Model DRQ-8/100-L48NB-C

Murata Power Solutions measures its products for radio frequency emissions against the EN 55022 and CISPR 22 standards. Passive resistance loads are employed and the output is set to the maximum voltage. If you set up your own emissions testing, make sure the output load is rated at continuous power while doing the tests.

The recommended external input and output capacitors (if required) are included. Please refer to the fundamental switching frequency. All of this information is listed in the Product Specifications. An external discrete filter is installed and the circuit diagram is shown below.

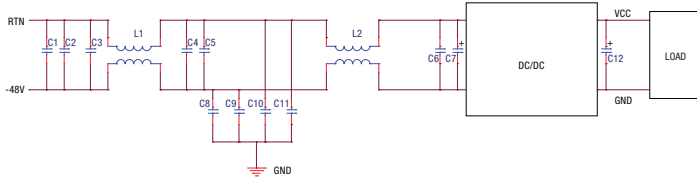

Figure 7. Conducted Emissions Test Circuit

[1] Conducted Emissions Parts List

Reference	Part Number	Description	Vendor
C1, C2, C3, C4, C5	GRM32ER72A105KA01L	SMD CERAMIC-100V-1000nF-X7R-1210	Murata
C6	GRM319R72A104KA01D	SMD CERAMIC100V-100nF-±10%-X7R-1206	Murata
L1, L2	PG0060T	COMMON MODE-473uH-±25%-14A	Pulse
C8, C9, C10, C11	GRM55DR72J224KW01L	SMD CERAMIC630V-0.22uF-±10%-X7R-2220	Murata
C7	UHE2A221MHD	Aluminum100V-220uF-±10%-long lead	Nichicon
C12	NA		

[2] Conducted Emissions Test Equipment Used

- Hewlett Packard HP8594L Spectrum Analyzer – S/N 3827A00153
- 2Line V-networks LS1-15V 50Ω/50uH Line Impedance Stabilization Network

[3] Conducted Emissions Test Results

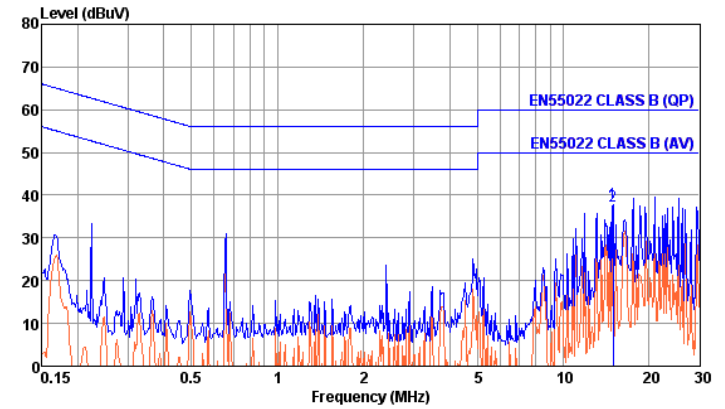

Graph 1. Conducted emissions performance, Positive Line, CISPR 22, Class B, half load

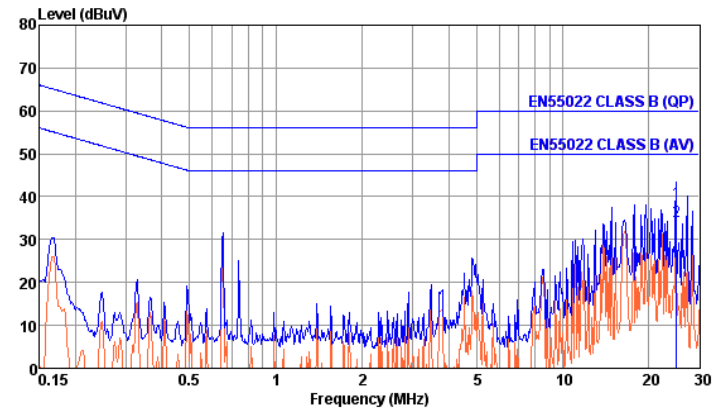

Graph 2. Conducted emissions performance, Negative Line, CISPR 22, Class B, half load

[4] Layout Recommendations

Most applications can use the filtering which is already installed inside the converter or with the addition of the recommended external capacitors. For greater emissions suppression, consider additional filter components and/or shielding. Emissions performance will depend on the user's PC board layout, the chassis shielding environment and choice of external components. Please refer to Application Note GEAN-02 for further discussion.

Since many factors affect both the amplitude and spectra of emissions, we recommend using an engineer who is experienced at emissions suppression.

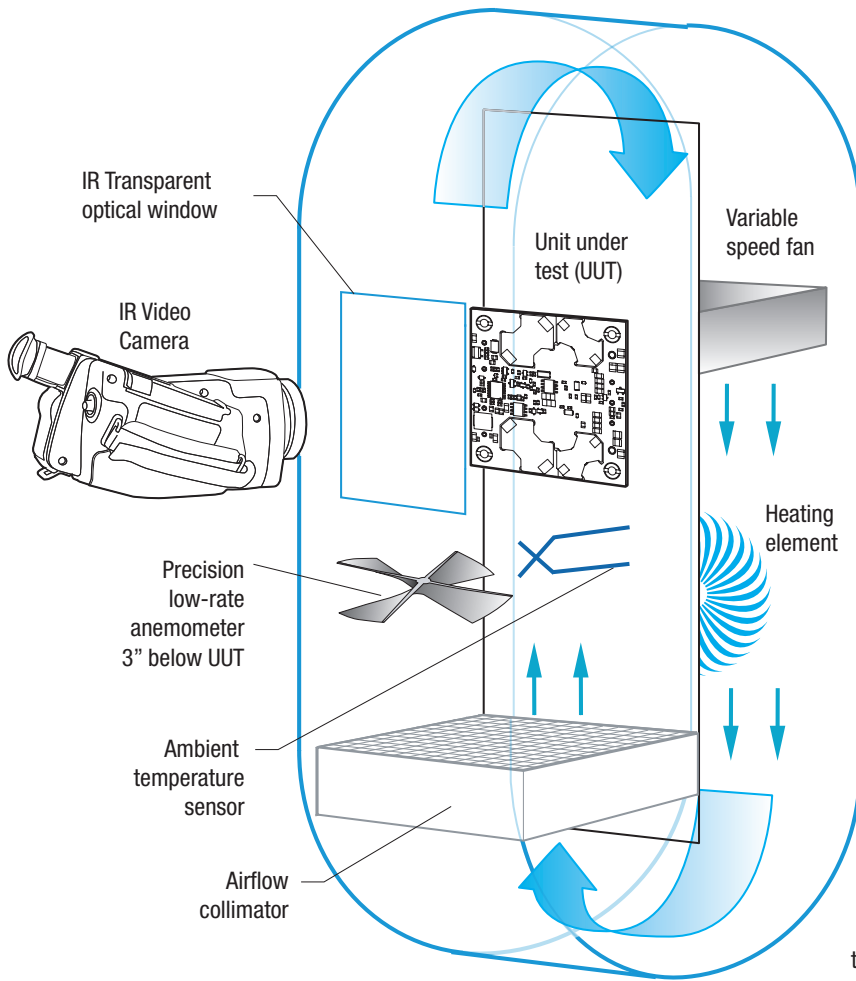

Figure 8. Vertical Wind Tunnel

Vertical Wind Tunnel

Murata Power Solutions employs a computer controlled custom-designed closed loop vertical wind tunnel, infrared video camera system, and test instrumentation for accurate airflow and heat dissipation analysis of power products. The system includes a precision low flow-rate anemometer, variable speed fan, power supply input and load controls, temperature gauges, and adjustable heating element.

The IR camera monitors the thermal performance of the Unit Under Test (UUT) under static steady-state conditions. A special optical port is used which is transparent to infrared wavelengths.

Both through-hole and surface mount converters are soldered down to a 10" x 10" host carrier board for realistic heat absorption and spreading. Both longitudinal and transverse airflow studies are possible by rotation of this carrier board since there are often significant differences in the heat dissipation in the two airflow directions. The combination of adjustable airflow, adjustable ambient heat, and adjustable Input/Output currents and voltages mean that a very wide range of measurement conditions can be studied.

The collimator reduces the amount of turbulence adjacent to the UUT by minimizing airflow turbulence. Such turbulence influences the effective heat transfer characteristics and gives false readings. Excess turbulence removes more heat from some surfaces and less heat from others, possibly causing uneven overheating.

Both sides of the UUT are studied since there are different thermal gradients on each side. The adjustable heating element and fan, built-in temperature gauges, and no-contact IR camera mean that power supplies are tested in real-world conditions.

Soldering Guidelines







Murata Power Solutions recommends the specifications below when installing these converters. These specifications vary depending on the solder type. Exceeding these specifications may cause damage to the product. Your production environment may differ; therefore please thoroughly review these guidelines with your process engineers.

Wave Solder Operations for through-hole mounted products (THMT)			
For Sn/Ag/Cu based solders:		For Sn/Pb based solders:	
Maximum Preheat Temperature	115° C.	Maximum Preheat Temperature	105° C.
Maximum Pot Temperature	270° C.	Maximum Pot Temperature	250° C.
Maximum Solder Dwell Time	7 seconds	Maximum Solder Dwell Time	6 seconds

PRODUCT AVAILABILITY

MPS Part Number	Product Status	LTB Date
DRQ-8/100-L48NBA-C	Discontinued	3/31/2022
DRQ-8/100-L48NBAG-C	Discontinued	3/31/2022
DRQ-8/100-L48NBAS-C	Discontinued	3/31/2022
DRQ-8/100-L48NBASG-C	Discontinued	3/31/2022
DRQ-8/100-L48NB-C	Discontinued	3/31/2022
DRQ-8/100-L48NBG-C	Discontinued	3/31/2022
DRQ-8/100-L48NBS-C	Discontinued	3/31/2022
DRQ-8/100-L48NBSG-C	Discontinued	3/31/2022
DRQ-8/100-L48NBZ-C	In Production	N/A
DRQ-8/100-L48NBZG-C	Discontinued	3/31/2022
DRQ-8/100-L48NBZS-C	Discontinued	3/31/2022
DRQ-8/100-L48NBZSG-C	Discontinued	3/31/2022
DRQ-8/100-L48PBA-C	Discontinued	3/31/2022
DRQ-8/100-L48PBAG-C	Discontinued	3/31/2022
DRQ-8/100-L48PBAS-C	Discontinued	3/31/2022
DRQ-8/100-L48PBASG-C	Discontinued	3/31/2022
DRQ-8/100-L48PB-C	Discontinued	3/31/2022
DRQ-8/100-L48PBG-C	Discontinued	3/31/2022
DRQ-8/100-L48PBS-C	Discontinued	3/31/2022
DRQ-8/100-L48PBSG-C	Discontinued	3/31/2022
DRQ-8/100-L48PBZ-C	Discontinued	3/31/2022
DRQ-8/100-L48PBZG-C	Discontinued	3/31/2022
DRQ-8/100-L48PBZS-C	Discontinued	3/31/2022
DRQ-8/100-L48PBZSG-C	Discontinued	3/31/2022

Product Status

	Products under development. Listed product specifications are subject to change without prior notice. Please contact us for sample availability and mass production schedule.
	Product is in mass production.
	Not recommended for new design.
	We are planning to discontinue production of this item. 'Last Time Buy' date or Discontinuation date may be shown on our web site. Before these dates, please contact us with your requirements.
	Production of this product has stopped.
	Murata particularly recommends this product for reasons of size and performance. Please contact Murata regarding pricing and delivery.
	This is a new product. Please contact Murata regarding pricing and delivery.

Murata Power Solutions, Inc.
 129 Flanders Rd. Westborough, MA 01581, USA.
 ISO 9001 and 14001 REGISTERED



**This product is subject to the following [operating requirements](#) and the [Life and Safety Critical Application Sales Policy](#):
 Refer to: <https://www.murata-ps.com/requirements/>**

Murata Power Solutions, Inc. makes no representation that the use of its products in the circuits described herein, or the use of other technical information contained herein, will not infringe upon existing or future patent rights. The descriptions contained herein do not imply the granting of licenses to make, use, or sell equipment constructed in accordance therewith. Specifications are subject to change without notice. © 2022 Murata Power Solutions, Inc.