

Description

Single pole high performance thermal circuit breaker with tease-free, trip-free, snap action mechanism and push/pull on/off manual actuation (M-type TO CBE to EN 60934). An indicator band on the push button clearly shows the tripped/off position. Threadneck panel mounted and available in tracked vehicle, aircraft and general purpose versions.

Typical applications

Extra low voltage wiring systems on all types of vehicles for land, sea and air; defence equipment; battery powered machines.

Ordering information

Type No.	412	threadneck panel mounting
Terminal design	K14	screw terminals M4 (to aircraft specs.)
	K54	screw terminals M4 sealed housing (to vehicle specs.)
Version	FN2	vehicle application, nickel-plated
	LN2	aircraft application, black finish
	N2	general application, nickel-plated
Current ratings	6...25 A	(-FN2)
	7.5...35 A	(-LN2/N2)
412 - K14 - LN2 - 10 A ordering example		

Please be informed that we have minimum ordering quantities to be observed.

Preferred types

Preferred types	Standard current ratings (A)								
	6	7.5	8	10	15	20	25	30	35
412-K54-FN2-	x	x	x	x	x	x	x		
412-K14-LN2-		x	x	x	x	x	x	x	x
412-K54-LN2-			x	x	x	x	x	x	x

Standard current ratings and typical voltage drop values

Current rating (A)	Voltage drop (mV)		Current rating (A)	Voltage drop (mV)	
	-LN/N	-FN		-LN/N	-FN
6	-	≤ 300	15	≤ 200	≤ 200
7.5	≤ 300	≤ 250	20	≤ 200	≤ 200
8	≤ 250	≤ 200	25	≤ 200	≤ 200
10	≤ 200	≤ 200	30	≤ 200	-
12	≤ 200	≤ 200	35	≤ 200	-
13	≤ 200	≤ 200			

Approvals

Authority	Standard	Rated voltage	Current ratings
UL	UL 1077	DC 28 V	0.1 A...35 A
CSA	C22.2 No 235	DC 28 V	0.1 A...35 A



412-...

Technical data

For further details please see: www.e-t-a.de/ti_e

Voltage rating	DC 28 V	AC 115 V (400 Hz) upon request
Current rating range	6...25 A (-FN2) 7.5...35 A (-LN2/-N2), lower current ratings to special order	
Typical life	4,000 operations at 2 x I _N	
Ambient temperature	-55...+75 °C (-67...+167 °F)	
Insulation co-ordination (IEC 60664 and 60664A)	rated impulse withstand voltage 1.5 kV	pollution degree 3
Dielectric strength (IEC 60664 and 60664A)	test voltage operating area	AC 1,500 V
Insulation resistance	> 100 MΩ (DC 500 V)	
Interrupting capacity I _{cn}	6,000 A	
Interrupting capacity (UL 1077)	6,000 A	
Degree of protection (IEC 60529/DIN 40050)	operating area IP40 terminal area IP00	
Vibration	10 g (56-500 Hz), ± 0.76 mm (10-55 Hz) to VG 95210, sheet 19, MIL-STD-202, meth. 204, IEC 60068-2-6, test Fc	
Shock	25 g (11 ms) to VG 95210, sheet 28, MIL-STD-202, meth. 213, IEC 60068-2-27, test Ea	
Corrosion	96 hours at 5 % salt mist, to VG 95210, sheet 2, MIL-STD-202, meth. 101, IEC 60068-2-11, test Ka	
Humidity	240 hours at 95 % RH to VG 95210, sheet 7, MIL-STD-202, meth. 106, IEC 60068-2-3, test Ca	
Mass	approx. 40 g	

Dimensions

412-K54-FN2/N2

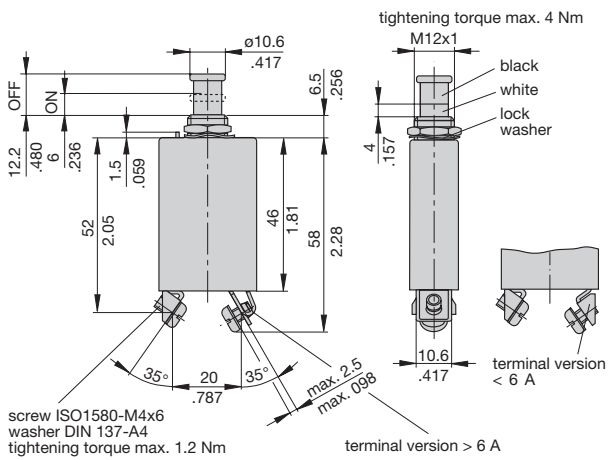

412-K14/K54-FN2/N2

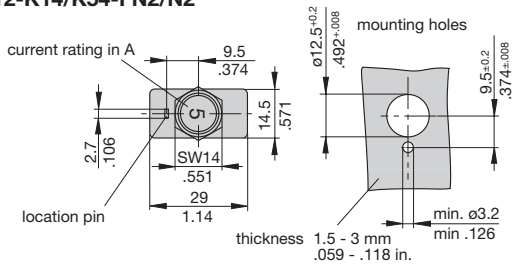

412-K14-LN2

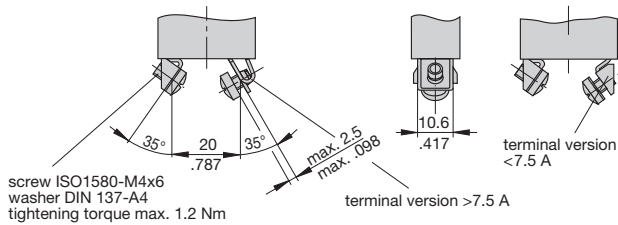

412-K14/K54-LN2

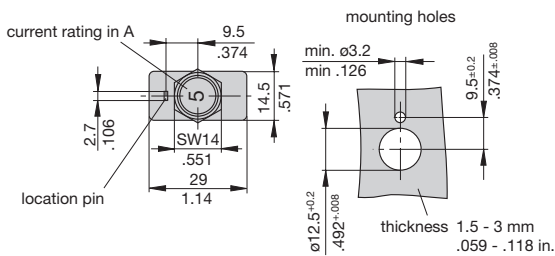

Internal connection diagram

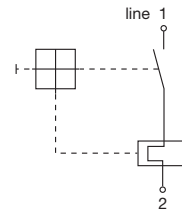

Typical time/current characteristics

412-...-FN2 6...25 A

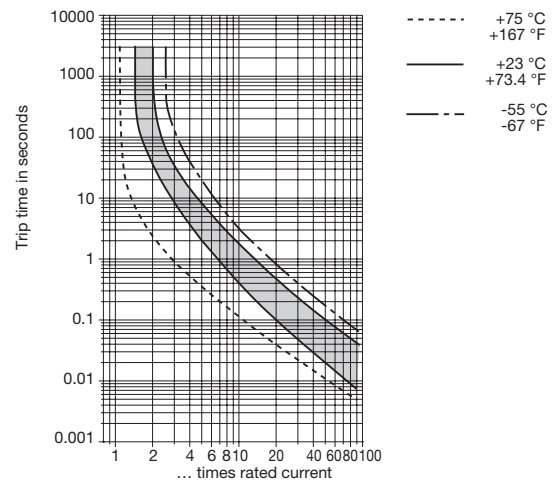

412-..LN2/-N2 7.5...35 A

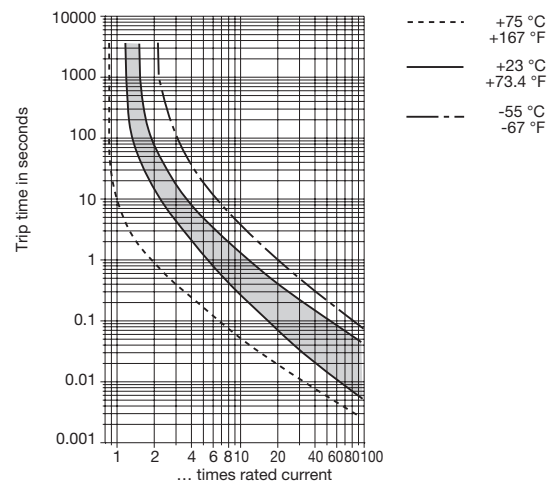

This is a metric design and millimeter dimensions take precedence ($\frac{\text{mm}}{\text{inch}}$)

Accessories (approved to VG 95345, part 23)

Splash cover /hex nut assembly with O ring (IP66 and IP67)
X 200 801 08 nickel plated nut M12x1, transparent cover
X 200 801 03 matt black finish nut M12x1, black cover
X 200 801 12 with blackened nut and transparent cover

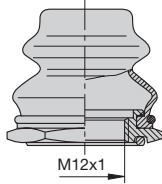

Splash cover black /hex nut assembly with O ring (IP54)
X 200 802 01 nickel plated nut M12x1
X 200 802 02 matt black finish nut M12x1

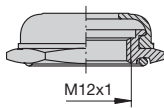

Actuator extension (black)
 to be fitted on the push button
X 200 803 01

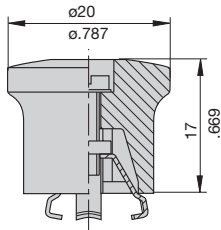

Accessories

Identification collar to be snapped on the push button
Y 307 004 01 black
Y 307 004 02 white
Y 307 004 03 red
Y 307 004 04 green
Y 307 004 05 blue

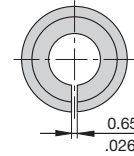
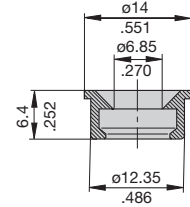

Lock out ring to block the push button in OFF position
Y 307 005 01 red
Y 307 005 02 black

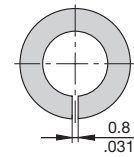
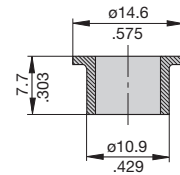

This is a metric design and millimeter dimensions take precedence ($\frac{\text{mm}}{\text{inch}}$)

All dimensions without tolerances are for reference only. In the interest of improved design, performance and cost effectiveness the right to make changes in these specifications without notice is reserved. Product markings may not be exactly as the ordering codes. Errors and omissions excepted.

