



Part Number: DSC1722

Electrical Specifications

Frequency Range (GHz):	17.3 – 33.0
Isolation (dB):	20 MIN
Insertion Loss (dB):	0.6 MAX
VSWR:	1.25:1 MIN
Forward Power (W):	10 AVG 30 PK

Mechanical/Environmental Specifications

Connector Type:	SMA
Connector Body:	Passivated stainless steel
Connector Pin:	Gold plated copper
Load Body:	Brass
Magnetic Shunt:	Nickel plated CRS
Operational Temp:	-20°C to +65°C
Storage Temp:	-40°C to +120°C
Weight (oz):	0.9 MAX
Pressure:	< 1.5e ⁻⁵ torr
Screening Test:	Non-Operational Thermal Cycles
ATP:	Operational thermal cycling

Test Report Included w/CofC. To customize test procedures or specifications to your requirements, please contact DiTom.

DSC1722 Dimensions

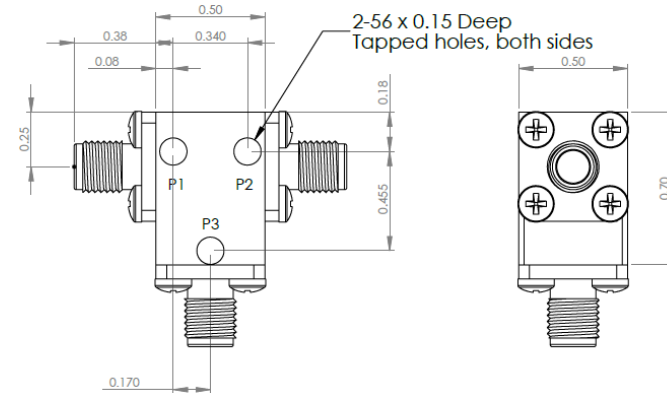

DSC1722-3 Dimensions

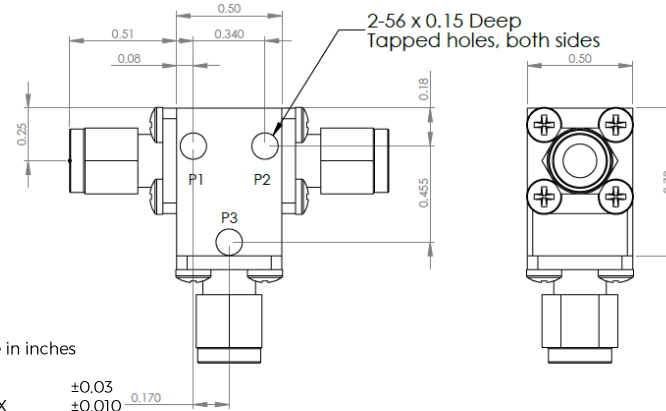

Dimensions are in inches
Tolerance

XX ±0.03
XXX ±0.010

Type of Device	PN Suffix	Connector Configuration Input / Output	PN Example
Single Junction Circulator 3-Port Device Port 1 / Port 2 / Port 3	No Dash	Female / Female / Female	DSC1722
	-1	Male / Female / Female	DSC1722-1
	-2	Female / Male / Female	DSC1722-2
	-3	Male / Male / Male	DSC1722-3
	-4	Female / Female / Male	DSC1722-4
	-5	Male / Female / Male	DSC1722-5
	-6	Male / Male / Female	DSC1722-6
	-7	Female / Male / Male	DSC1722-7



MEASURED DATA

Part Number: DSC1722, P1→P2, P3 Terminated with 50Ω, +25°C

