

BWVF Series



BWVF series, an automatic assembly constructed power inductor, is shielded with magnetic resin and suitable for portable DC-DC converter applications.

Features

- RoHS, Halogen Free and REACH Compliance
- Shielded with magnetic resin
- Various package size and wide inductance range
- Optimize electrical characteristics by using different ferrite core figures

Applications

- Smartphones, tablets and wearable devices
- DSC, camcorders
- AP Routers
- STBs
- LCD TVs, monitors and panels
- Game consoles
- DC/DC converters

Product Identification

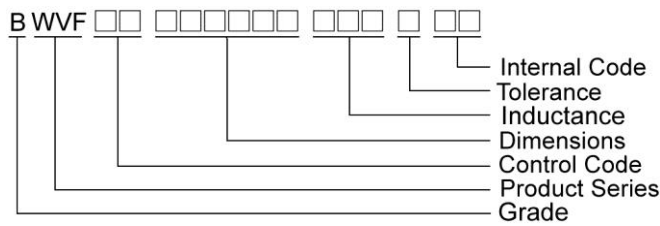

Shape and Dimensions

Figure 1

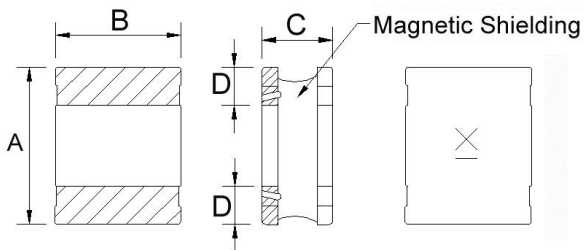
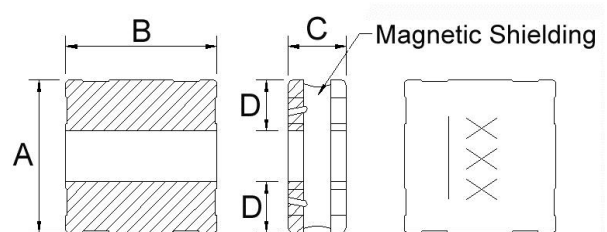

Figure 2



Dimensions in mm

TYPE	FIG	A	B	C	D	H	I	J
BWVF00201612	1	2.0±0.25	1.6±0.25	1.2±0.05	0.6	1.8	0.8	0.8
BWVF00252010	1	2.5±0.25	2.0±0.25	1.02 Max	0.8	2.2	0.85	0.8
BWVF00252012	1	2.5±0.25	2.0±0.25	1.2±0.05	0.8	2.2	0.85	0.8
BWVF00303010	2	3.0±0.20	3.0±0.20	1.02 Max	1.0	3.2	1.1	1.0
BWVF00303012	2	3.0±0.20	3.0±0.20	1.2 Max	1.0	3.2	1.1	1.0
BWVF00303015	2	3.0±0.20	3.0±0.20	1.5 Max	1.0	3.2	1.1	1.0
BWVF00404012	2	4.0±0.20	4.0±0.20	1.2±0.1	1.5	4.2	1.5	1.2

Recommended Pattern

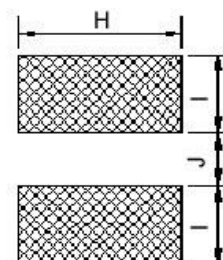

Sealed Power Inductors – BWVF Series

Shape and Dimensions

Figure 3

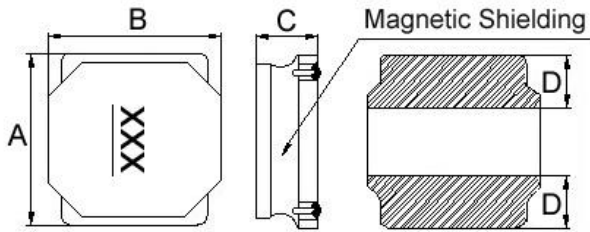
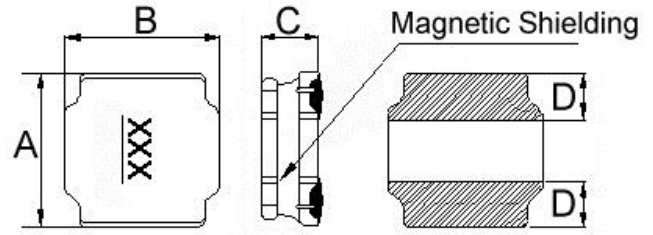

Figure 4



Dimensions in mm

TYPE	FIG	A	B	C	D	H	I	J
BWVF00404015	3	4.0±0.25	4.0±0.25	1.5±0.2	1.3	3.7	1.5	1.2
BWVF00404018	3	4.0±0.20	4.0±0.20	1.9 Max	1.3	3.7	1.5	1.2
BWVF00404026	3	4.0±0.20	4.0±0.25	2.6±0.2	1.4	3.7	1.6	1.2
BWVF00505020	4	5.0±0.20	5.0±0.20	2.0±0.2	1.8±0.3	4.2	1.6	2.0
BWVF00606020	4	6.0±0.20	6.0±0.20	2.0±0.2	1.7±0.3	5.7	1.7	2.8
BWVF00606028	4	6.0±0.20	6.0±0.20	2.8±0.2	1.9±0.3	5.7	1.8	2.6
BWVF00808040	4	8.0±0.20	8.0±0.20	4.0 ^{+0.2} _{-0.30}	2.3±0.3	7.5	2.5	3.4

Recommended Pattern

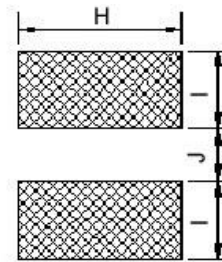

Sealed Power Inductors – BWVF Series

Electrical Characteristics

Part Number	Inductance (uH)	Tolerance (±%)	Test Frequency (MHz)	RDC (Ω) ±30%	Isat (A) Typ. (Max)	Irms (A) Typ. (Max)	Marking
BWVF00201612R47□00	0.47	20, 30	1	0.051	2.70(2.43)	2.30(2.07)	A
BWVF00201612R68□00	0.68	20, 30	1	0.074	2.20(1.98)	2.00(1.80)	L
BWVF002016121R5□00	1.5	20, 30	1	0.130	1.60(1.44)	1.45(1.30)	D
BWVF002016126R8□00	6.8	20, 30	1	0.465	0.82(0.73)	0.78(0.70)	H

Note: When ordering, please specify tolerance code. Tolerance: M=±20% , T =±30%

- Operating temperature range - 55°C ~ 125°C(Including self - temperature rise)
- Isat for Inductance drop 30% from its value without current
- I rms for a 40°C temperature rise from 25°C ambient with current
- Measure Equipment :
 L : Agilent HP4287A+Agilent HP16197A, 1MHz 200mV
 RDC : DIGITAL MILLINHM METER CHROMA 16502, or equivalent
 Isat & I rms : Agilent HP4284A

Test Instruments : HP4284A Material/Impedance Analyzer

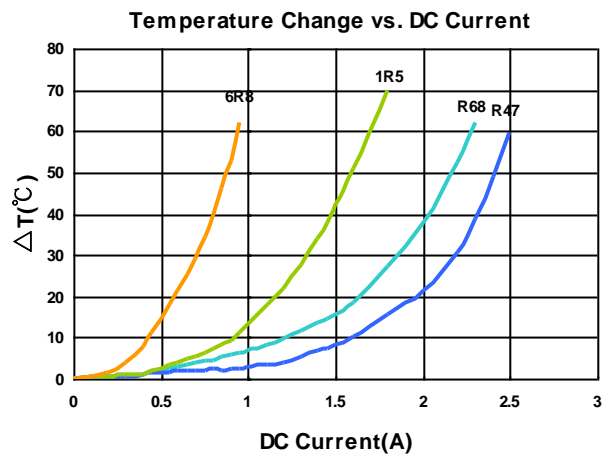
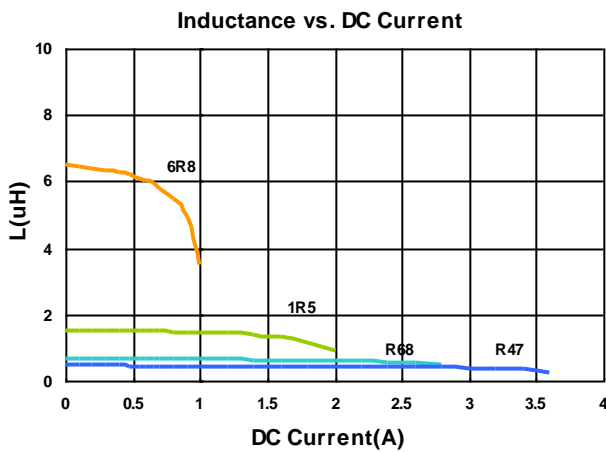

Electrical Characteristics

Part Number	Inductance (uH)	Tolerance (±%)	Test Frequency (MHz)	RDC (Ω) ±30%	Isat (A) Typ. (Max)	Irms (A) Typ. (Max)	Marking
BWVF00252010R47□00	0.47	20, 30	1	0.045	2.80(2.52)	2.30(2.07)	A
BWVF002520101R0□00	1.0	20, 30	1	0.066	1.98(1.78)	2.05(1.84)	B
BWVF002520101R5□00	1.5	20, 30	1	0.095	1.70(1.53)	1.85(1.66)	C
BWVF002520104R7□00	4.7	20, 30	1	0.285	0.92(0.82)	0.95(0.85)	F
BWVF00252010100□00	10	20, 30	1	0.535	0.60(0.54)	0.70(0.63)	H
BWVF00252010150□00	15	20, 30	1	0.810	0.50(0.45)	0.55(0.49)	I
BWVF00252010220□00	22	20, 30	1	1.200	0.40(0.36)	0.44(0.39)	J

Note: When ordering, please specify tolerance code. Tolerance: M=±20% , T =±30%

- Operating temperature range - 55°C ~ 125°C(Including self - temperature rise)
- Isat for Inductance drop 30% from its value without current
- Irms for a 40°C temperature rise from 25°C ambient with current
- Measure Equipment :
 L : Agilent HP4287A+Agilent HP16197A, 1MHz 200mV
 RDC : DIGITAL MILLINHM METER CHROMA 16502, or equivalent
 Isat & Irms : Agilent HP4284A

Test Instruments : HP4284A Material/Impedance Analyzer

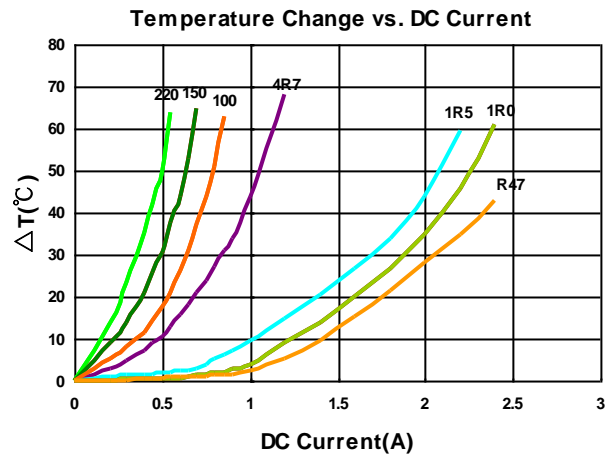
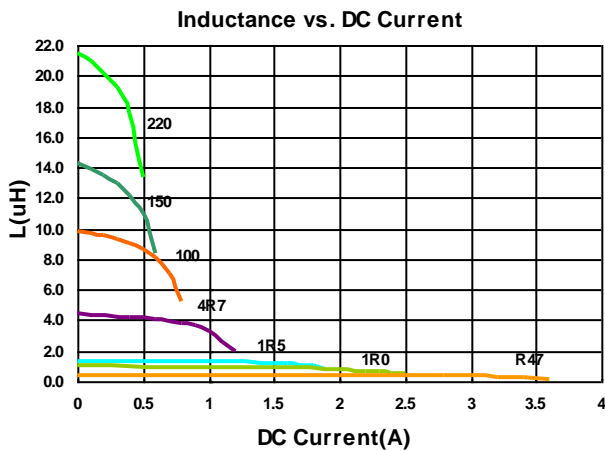

Sealed Power Inductors – BWVF Series

Electrical Characteristics

Part Number	Inductance (uH)	Tolerance (±%)	Test Frequency (MHz)	RDC (Ω) ±30%	Isat (A) Typ. (Max)	Irms (A) Typ. (Max)	Marking
BWVF00252012R50□00	0.50	20, 30	1	0.028	3.50(3.15)	3.00(2.70)	B
BWVF002520121R0□00	1.0	20, 30	1	0.050	2.50(2.25)	2.40(2.16)	C
BWVF002520121R2□00	1.2	20, 30	1	0.053	2.10(1.89)	2.35(2.11)	D
BWVF002520121R5□00	1.5	20, 30	1	0.068	1.95(1.75)	2.30(2.07)	E
BWVF002520122R2□00	2.2	20, 30	1	0.080	1.80(1.62)	1.80(1.62)	F
BWVF002520123R3□00	3.3	20, 30	1	0.130	1.45(1.30)	1.50(1.35)	G
BWVF002520124R7□00	4.7	20, 30	1	0.190	1.10(0.99)	1.10(0.99)	H
BWVF002520125R6□00	5.6	20, 30	1	0.210	1.05(0.94)	1.00(0.90)	I
BWVF002520126R8□00	6.8	20, 30	1	0.300	0.95(0.85)	0.80(0.72)	J
BWVF00252012100□00	10	20, 30	1	0.385	0.88(0.79)	0.70(0.63)	K
BWVF00252012150□00	15	20, 30	1	0.570	0.68(0.61)	0.62(0.55)	L
BWVF00252012220□00	22	20, 30	1	0.810	0.55(0.49)	0.53(0.47)	M

Note: When ordering, please specify tolerance code. Tolerance: M=±20% , T =±30%

- Operating temperature range - 55°C ~ 125°C(Including self - temperature rise)
- Isat for Inductance drop 30% from its value without current
- Irms for a 40°C temperature rise from 25°C ambient with current
- Measure Equipment :
 L : Agilent HP4287A+Agilent HP16197A, 1MHz 200mV
 RDC : DIGITAL MILLINHM METER CHROMA 16502, or equivalent
 Isat & Irms : Agilent HP4284A

Test Instruments : HP4284A Material/Impedance Analyzer

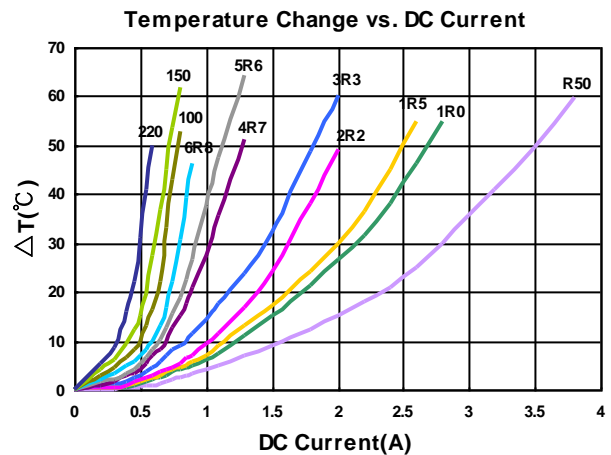
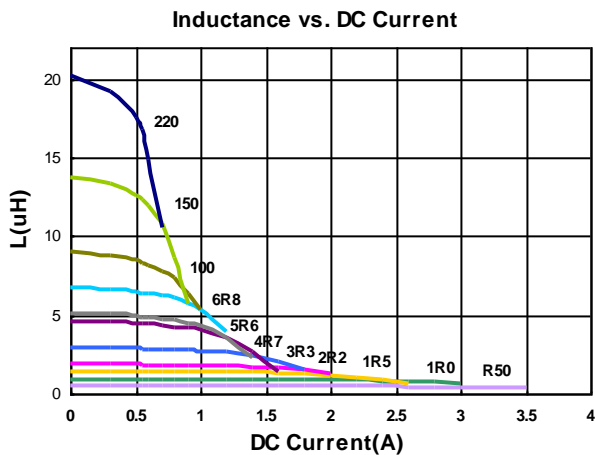

Please be sure to request approval specifications that provide further details of the products. Kindly note that the content of these specifications are subject to change or may be discontinued without prior notice. This product may not be designed/used in medical or high risk applications without Chilisin approval. Please contact our sales department before ordering.

Sealed Power Inductors – BWVF Series

Electrical Characteristics

Part Number	Inductance (uH)	Tolerance (±%)	Test Frequency (MHz)	RDC (Ω) ±30%	Isat (A) Typ. (Max)	Irms (A) Typ. (Max)	Marking
BWVF003030101R5□00	1.5	20, 30	1	0.085	1.80(1.62)	1.70(1.53)	1R5
BWVF003030102R2□00	2.2	20, 30	1	0.100	1.50(1.35)	1.40(1.26)	2R2
BWVF003030104R7□00	4.7	20, 30	1	0.205	1.00(0.90)	0.95(0.85)	4R7
BWVF003030106R8□00	6.8	20, 30	1	0.310	0.87(0.78)	0.85(0.76)	6R8
BWVF00303010100□00	10	20, 30	1	0.430	0.64(0.57)	0.63(0.56)	100
BWVF00303010150□00	15	20, 30	1	0.625	0.56(0.50)	0.55(0.49)	150
BWVF00303010220□00	22	20, 30	1	0.870	0.47(0.42)	0.46(0.41)	220
BWVF00303010470□00	47	20, 30	1	1.750	0.29(0.26)	0.28(0.25)	470

Note: When ordering, please specify tolerance code. Tolerance: M=±20% , T =±30%

- Operating temperature range - 55°C ~ 125°C(Including self - temperature rise)
- Isat for Inductance drop 30% from its value without current
- Iirms for a 40°C temperature rise from 25°C ambient with current
- Measure Equipment :
 L : Agilent HP4287A+Agilent HP16197A, 1MHz 200mV
 RDC : DIGITAL MILLINHM METER CHROMA 16502, or equivalent
 Isat & Iirms : Agilent HP4284A

Test Instruments : HP4284A Material/Impedance Analyzer

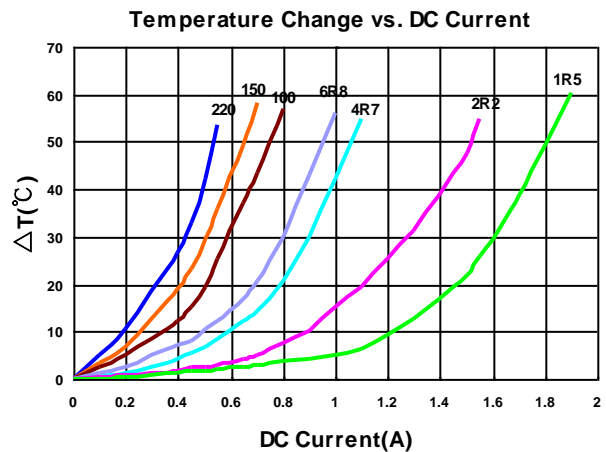
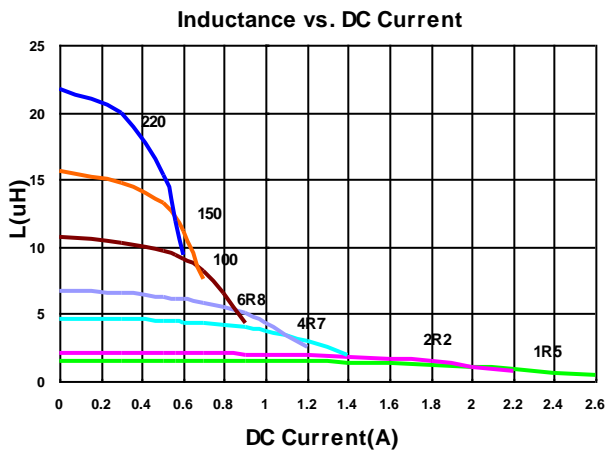

Sealed Power Inductors – BWVF Series

Electrical Characteristics

Part Number	Inductance (uH)	Tolerance (±%)	Test Frequency (MHz)	RDC (Ω) ±30%	Isat (A) Typ. (Max)	Irms (A) Typ. (Max)	Marking
BWVF003030122R2□00	2.2	20, 30	1	0.092	2.10(1.89)	2.00(1.80)	2R2
BWVF003030123R3□00	3.3	20, 30	1	0.13	1.84(1.65)	1.80(1.62)	3R3
BWVF003030124R7□00	4.7	20, 30	1	0.18	1.56(1.40)	1.52(1.36)	4R7
BWVF003030126R8□00	6.8	20, 30	1	0.25	1.32(1.18)	1.30(1.17)	6R8
BWVF00303012100□00	10	20, 30	1	0.42	1.06(0.95)	1.00(0.90)	100
BWVF00303012150□00	15	20, 30	1	0.56	0.82(0.73)	0.80(0.72)	150
BWVF00303012220□00	22	20, 30	1	0.86	0.64(0.57)	0.62(0.55)	220
BWVF00303012470□00	47	20, 30	1	1.82	0.49(0.44)	0.43(0.38)	470

Note: When ordering, please specify tolerance code. Tolerance: M=±20% , T =±30%

- Operating temperature range - 55°C ~ 125°C(Including self - temperature rise)
- Isat for Inductance drop 30% from its value without current
- Iirms for a 40°C temperature rise from 25°C ambient with current
- Measure Equipment :
 L : Agilent HP4287A+Agilent HP16197A, 1MHz 200mV
 RDC : DIGITAL MILLINHM METER CHROMA 16502, or equivalent
 Isat & Iirms : Agilent HP4284A

Test Instruments : HP4284A Material/Impedance Analyzer

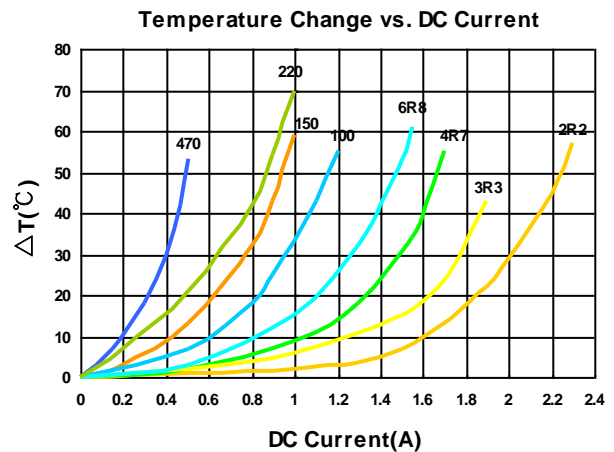
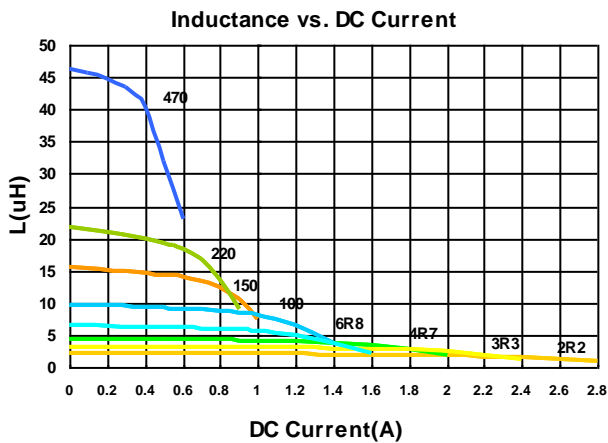

Please be sure to request approval specifications that provide further details of the products. Kindly note that the content of these specifications are subject to change or may be discontinued without prior notice. This product may not be designed/used in medical or high risk applications without Chilisin approval. Please contact our sales department before ordering.

Sealed Power Inductors – BWVF Series

Electrical Characteristics

Part Number	Inductance (uH)	Tolerance (±%)	Test Frequency (MHz)	RDC (Ω) ±30%	Isat (A) Typ. (Max)	Irms (A) Typ. (Max)	Marking
BWVF00303015R47□00	0.47	20, 30	1	0.036	4.7(4.23)	4.0(3.60)	R47
BWVF003030151R0□00	1.0	20, 30	1	0.054	3.4(3.06)	3.0(2.70)	1R0
BWVF003030151R5□00	1.5	20, 30	1	0.063	3.0(2.70)	2.6(2.34)	1R5
BWVF003030152R2□00	2.2	20, 30	1	0.090	2.3(2.07)	2.0(1.80)	2R2
BWVF003030153R3□00	3.3	20, 30	1	0.125	1.9(1.71)	1.80(1.62)	3R3
BWVF003030154R7□00	4.7	20, 30	1	0.170	1.58(1.42)	1.52(1.36)	4R7
BWVF003030156R8□00	6.8	20, 30	1	0.235	1.34(1.20)	1.30(1.17)	6R8
BWVF00303015100□00	10	20, 30	1	0.360	1.06(0.95)	1.00(0.90)	100
BWVF00303015150□00	15	20, 30	1	0.550	0.90(0.81)	0.80(0.72)	150
BWVF00303015220□00	22	20, 30	1	0.770	0.76(0.68)	0.65(0.58)	220
BWVF00303015330□00	33	20, 30	1	0.930	0.65(0.58)	0.60(0.54)	330
BWVF00303015470□00	47	20, 30	1	1.500	0.52(0.46)	0.42(0.37)	470
BWVF00303015101□00	100	20, 30	1	2.700	0.36(0.32)	0.3(0.27)	101

Note: When ordering, please specify tolerance code. Tolerance: M=±20% , T =±30%

- Operating temperature range - 55°C ~ 125°C(Including self - temperature rise)
- Isat for Inductance drop 30% from its value without current
- Iirms for a 40°C temperature rise from 25°C ambient with current
- Measure Equipment :
 L : Agilent HP4287A+Agilent HP16197A, 1MHz 200mV
 RDC : DIGITAL MILLINHM METER CHROMA 16502, or equivalent
 Isat & Iirms : Agilent HP4284A

Test Instruments : HP4284A Material/Impedance Analyzer

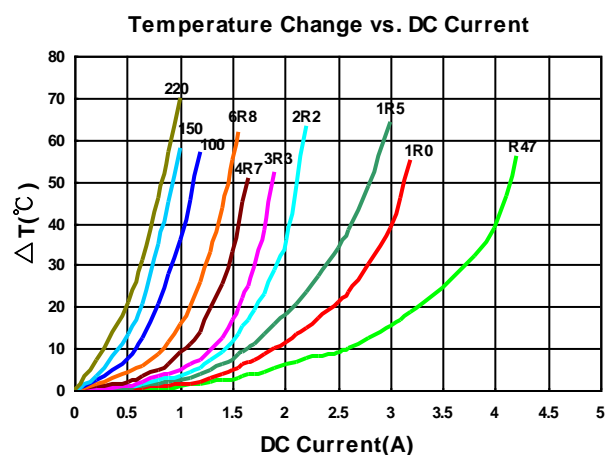
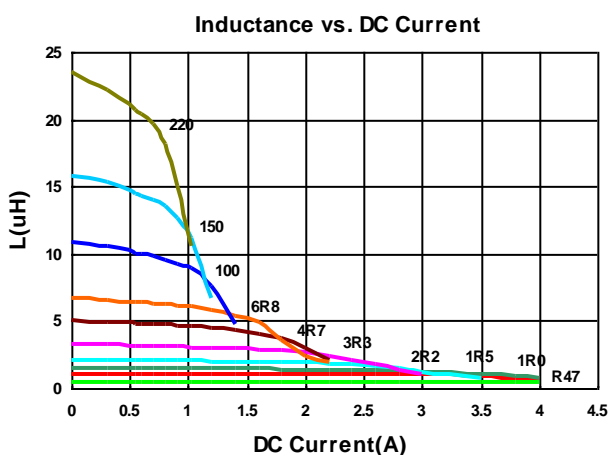

Please be sure to request approval specifications that provide further details of the products. Kindly note that the content of these specifications are subject to change or may be discontinued without prior notice. This product may not be designed/used in medical or high risk applications without Chilisin approval. Please contact our sales department before ordering.

Sealed Power Inductors – BWVF Series

Electrical Characteristics

Part Number	Inductance (uH)	Tolerance (±%)	Test Frequency (MHz)	RDC (Ω) ±30%	Isat (A) Typ. (Max)	Irms (A) Typ. (Max)	Marking
BWVF004040123R3□00	3.3	20, 30	1	0.072	1.52(1.36)	2.10(1.89)	3R3
BWVF00404012100□00	10	20, 30	1	0.190	0.90(0.81)	1.20(1.08)	100

Note: When ordering, please specify tolerance code. Tolerance: M=±20% , T =±30%

- Operating temperature range - 55°C ~ 125°C(Including self - temperature rise)
- Isat for Inductance drop 30% from its value without current
- Irms for a 40°C temperature rise from 25°C ambient with current
- Measure Equipment :
 L : Agilent HP4284A+Agilent HP42841A.1MHz 200mV
 RDC : DIGITAL MILLINHM METER CHROMA 16502, or equivalent
 Isat & Irms : Agilent HP4284A

Test Instruments : HP4284A Material/Impedance Analyzer

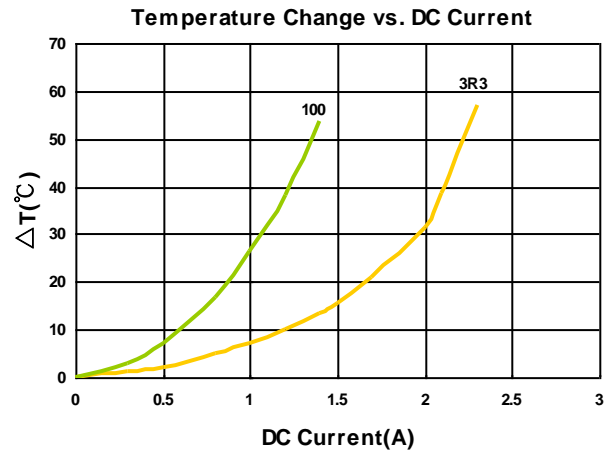
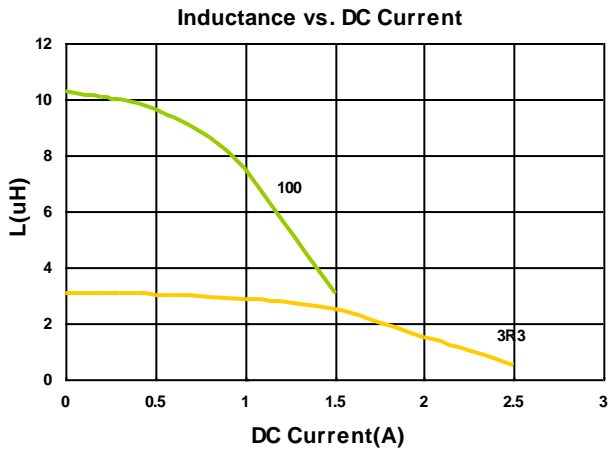

Sealed Power Inductors – BWVF Series

Electrical Characteristics

Part Number	Inductance (uH)	Tolerance (±%)	Test Frequency (MHz)	RDC (Ω) ±30%	Isat (A) Typ. (Max)	Irms (A) Typ. (Max)	Marking
BWVF00404015R47□00	0.47	20, 30	1	0.019	4.00(3.60)	4.20(3.78)	R47
BWVF004040151R5□00	1.5	20, 30	1	0.041	3.00(2.70)	3.2(2.88)	1R5
BWVF004040152R2□00	2.2	20, 30	1	0.054	2.30(2.07)	2.60(2.34)	2R2
BWVF004040154R7□00	4.7	20, 30	1	0.100	1.60(1.44)	1.80(1.62)	4R7
BWVF004040156R8□00	6.8	20, 30	1	0.138	1.40(1.26)	1.60(1.44)	6R8
BWVF00404015100□00	10	20, 30	1	0.200	1.00(0.90)	1.20(1.08)	100
BWVF00404015150□00	15	20, 30	1	0.300	0.92(0.82)	1.05(0.94)	150
BWVF00404015220□00	22	20, 30	1	0.400	0.72(0.64)	0.85(0.76)	220

Note: When ordering, please specify tolerance code. Tolerance: M=±20% , T =±30%

- Operating temperature range - 55°C ~ 125°C(Including self - temperature rise)
- Isat for Inductance drop 30% from its value without current
- Iirms for a 40°C temperature rise from 25°C ambient with current
- Measure Equipment :
 L : Agilent HP4284A+Agilent HP42841A.1MHz 200mV
 RDC : DIGITAL MILLINHM METER CHROMA 16502, or equivalent
 Isat & Iirms : Agilent HP4284A

Test Instruments : HP4284A Material/Impedance Analyzer

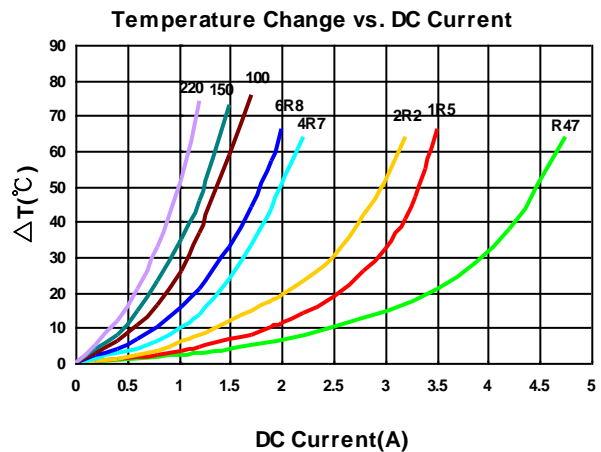
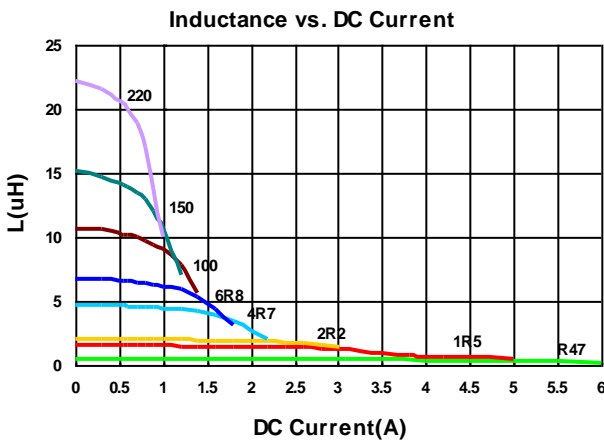

Please be sure to request approval specifications that provide further details of the products. Kindly note that the content of these specifications are subject to change or may be discontinued without prior notice. This product may not be designed/used in medical or high risk applications without Chilisin approval. Please contact our sales department before ordering.

Sealed Power Inductors – BWVF Series

Electrical Characteristics

Part Number	Inductance (uH)	Tolerance (±%)	Test Frequency (kHz)	RDC (Ω) ±30%	Isat (A) Typ. (Max)	Irms (A) Typ. (Max)	Marking
BWVF004040181R0□00	1.0	20, 30	100	0.0265	4.2(3.78)	3.8(3.42)	1R0
BWVF004040181R5□00	1.5	20, 30	100	0.0370	3.5(3.15)	3.2(2.88)	1R5
BWVF004040182R2□00	2.2	20, 30	100	0.0470	3.0(2.70)	2.7(2.43)	2R2
BWVF004040183R3□00	3.3	20, 30	100	0.0625	2.3(2.07)	2.1(1.89)	3R3
BWVF00404018220□00	22	20, 30	100	0.335	0.90(0.81)	0.88(0.79)	220

Note: When ordering, please specify tolerance code. Tolerance: M=±20% , T =±30%

- Operating temperature range - 55°C ~ 125°C(Including self - temperature rise)
- Isat for Inductance drop 30% from its value without current
- Iirms for a 40°C temperature rise from 25°C ambient with current
- Measure Equipment :
 L : Agilent HP4284A+Agilent HP42841A, 100kHz 1V
 RDC : DIGITAL MILLINHM METER CHROMA 16502, or equivalent
 Isat & Iirms : Agilent HP4284A

Test Instruments : HP4284A Material/Impedance Analyzer

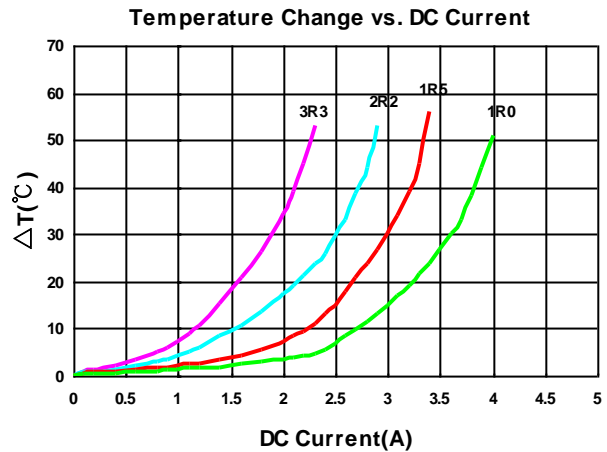
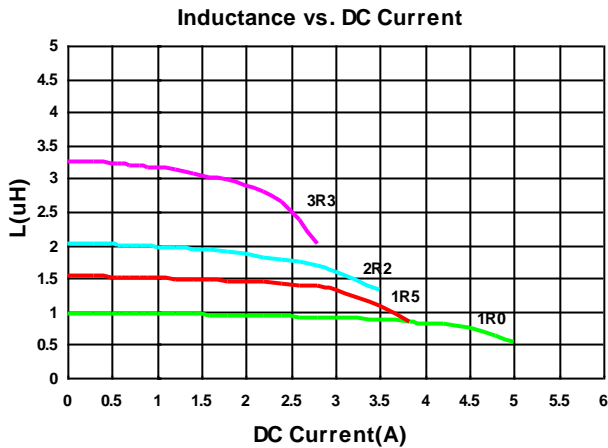

Electrical Characteristics

Part Number	Inductance (uH)	Tolerance (±%)	Test Frequency (kHz)	RDC (Ω) ±30%	Isat (A) Typ. (Max)	Irms (A) Typ. (Max)	Marking
BWVF004040261R0□00	1.0	20, 30	100	0.030	5.00(4.50)	4.00(3.60)	1R0
BWVF004040261R5□00	1.5	20, 30	100	0.035	4.20(3.78)	3.70(3.33)	1R5
BWVF004040262R2□00	2.2	20, 30	100	0.045	3.80(3.42)	3.50(3.15)	2R2
BWVF004040263R3□00	3.3	20, 30	100	0.067	3.00(2.70)	2.50(2.25)	3R3
BWVF004040264R7□00	4.7	20, 30	100	0.092	2.60(2.34)	2.00(1.80)	4R7
BWVF004040265R6□00	5.6	20, 30	100	0.110	2.30(2.07)	1.90(1.71)	5R6
BWVF004040266R8□00	6.8	20, 30	100	0.130	2.00(1.80)	1.70(1.53)	6R8
BWVF00404026100□00	10	20, 30	100	0.188	1.90(1.71)	1.40(1.26)	100
BWVF00404026150□00	15	20, 30	100	0.240	1.45(1.30)	1.20(1.08)	150
BWVF00404026220□00	22	20, 30	100	0.330	1.22(1.09)	1.00(0.90)	220
BWVF00404026330□00	33	20, 30	100	0.480	1.00(0.90)	0.82(0.73)	330
BWVF00404026470□00	47	20, 30	100	0.735	0.88(0.79)	0.64(0.57)	470
BWVF00404026101□00	100	20, 30	100	1.380	0.58(0.52)	0.50(0.45)	101
BWVF00404026331□00	330	20, 30	100	4.600	0.31(0.27)	0.25(0.22)	331

Note: When ordering, please specify tolerance code. Tolerance: M=±20% , T =±30%

- Operating temperature range - 55°C ~ 125°C(Including self - temperature rise)
- Isat for Inductance drop 30% from its value without current
- Iirms for a 40°C temperature rise from 25°C ambient with current
- Measure Equipment :
- L : Agilent HP4284A+Agilent HP42841A, 100kHz 1V
- RDC : DIGITAL MILLINHM METER CHROMA 16502, or equivalent
- Isat & Iirms : Agilent HP4284A

Test Instruments : HP4284A Material/Impedance Analyzer

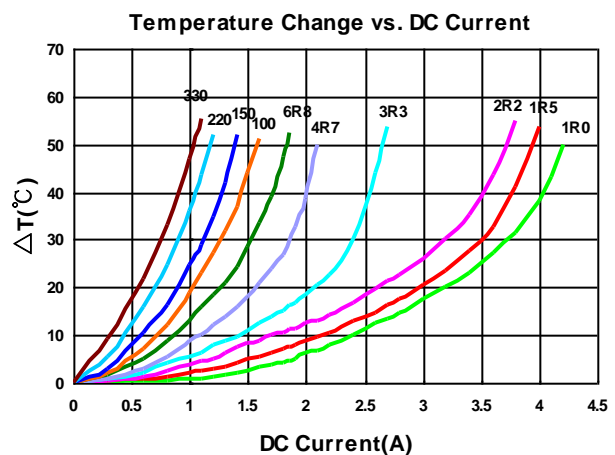
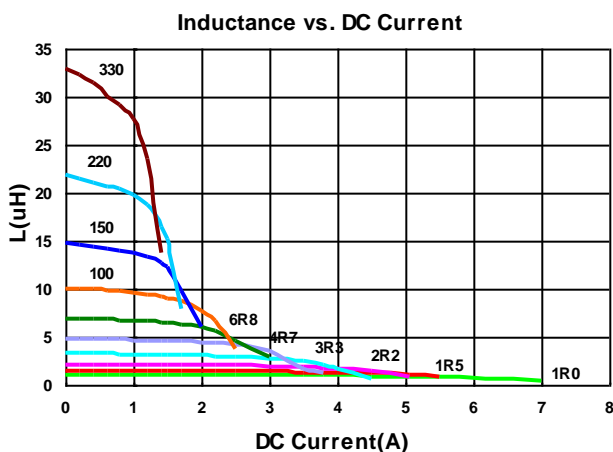

Sealed Power Inductors – BWVF Series

Electrical Characteristics

Part Number	Inductance (uH)	Tolerance (±%)	Test Frequency (kHz)	RDC (Ω) ±30%	Isat (A) Typ. (Max)	Irms (A) Typ. (Max)	Marking
BWVF005050201R0□00	1.0	20, 30	100	0.018	6.0(5.40)	4.1(3.69)	1R0
BWVF005050201R5□00	1.5	20, 30	100	0.023	4.9(4.41)	3.5(3.15)	1R5
BWVF005050201R8□00	1.8	20, 30	100	0.026	4.1(3.60)	3.4(3.00)	1R8
BWVF005050202R2□00	2.2	20, 30	100	0.030	4.0(3.60)	3.3(2.97)	2R2
BWVF005050203R6□00	3.6	20, 30	100	0.050	3.1(2.70)	2.7(2.40)	3R6
BWVF005050203R9□00	3.9	20, 30	100	0.053	2.9(2.61)	2.6(2.34)	3R9
BWVF005050204R7□00	4.7	20, 30	100	0.060	2.7(2.43)	2.2(1.98)	4R7
BWVF005050206R8□00	6.8	20, 30	100	0.093	2.2(1.98)	1.8(1.62)	6R8
BWVF00505020100□00	10	20, 30	100	0.125	1.8(1.62)	1.6(1.44)	100
BWVF00505020150□00	15	20, 30	100	0.195	1.4(1.26)	1.2(1.08)	150
BWVF00505020220□00	22	20, 30	100	0.265	1.2(1.08)	1.0(0.90)	220

Note: When ordering, please specify tolerance code. Tolerance: M=±20% , T =±30%

- Operating temperature range - 55°C ~ 125°C(Including self - temperature rise)
- Isat for Inductance drop 30% from its value without current
- Irms for a 40°C temperature rise from 25°C ambient with current
- Measure Equipment :
- L : Agilent HP4284A+Agilent HP42841A, 100kHz 1V
RDC : DIGITAL MILLINHM METER CHROMA 16502, or equivalent
Isat & Irms : Agilent HP4284A

Test Instruments : HP4284A Material/Impedance Analyzer

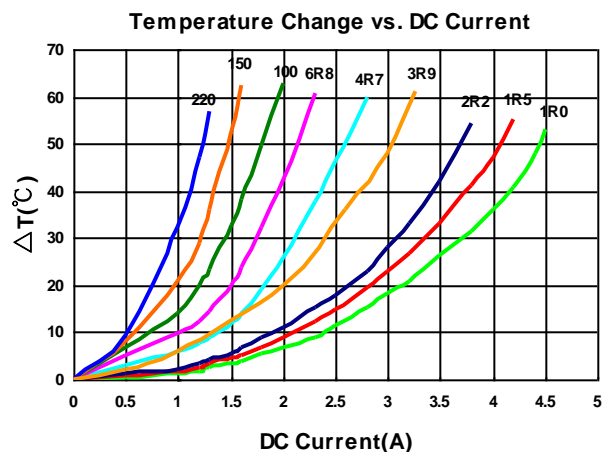
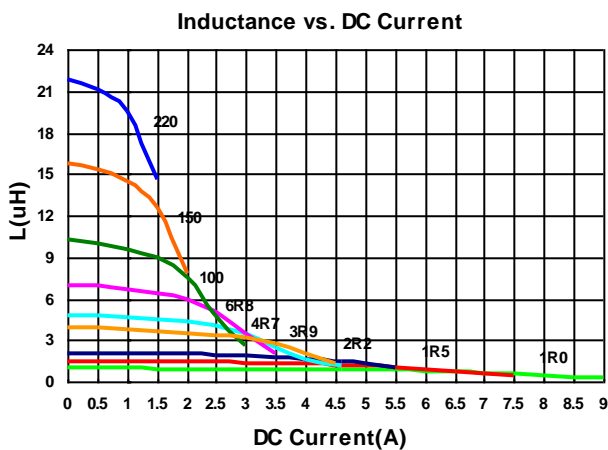

Please be sure to request approval specifications that provide further details of the products. Kindly note that the content of these specifications are subject to change or may be discontinued without prior notice. This product may not be designed/used in medical or high risk applications without Chilisin approval. Please contact our sales department before ordering.

Sealed Power Inductors – BWVF Series

Electrical Characteristics

Part Number	Inductance (uH)	Tolerance (±%)	Test Frequency (kHz)	RDC (Ω) ±30%	Isat (A) Typ. (Max)	Irms (A) Typ. (Max)	Marking
BWVF006060204R7□00	4.7	20, 30	100	0.058	3.0(2.70)	2.3(2.07)	4R7
BWVF00606020100□00	10	20, 30	100	0.130	2.1(1.89)	1.6(1.44)	100
BWVF00606020150□00	15	20, 30	100	0.195	1.6(1.44)	1.3(1.17)	150
BWVF00606020220□00	22	20, 30	100	0.260	1.3(1.17)	1.1(0.99)	220
BWVF00606020470□00	47	20, 30	100	0.510	0.9(0.80)	0.8(0.72)	470

Note: When ordering, please specify tolerance code. Tolerance: M=±20% , T =±30%

- Operating temperature range - 55°C ~ 125°C(Including self - temperature rise)
- Isat for Inductance drop 30% from its value without current
- I rms for a 40°C temperature rise from 25°C ambient with current
- Measure Equipment :
- L : Agilent HP4284A+Agilent HP42841A, 100kHz 1V
- RDC : DIGITAL MILLINHM METER CHROMA 16502, or equivalent
- Isat & I rms : Agilent HP4284A

Test Instruments : HP4284A Material/Impedance Analyzer

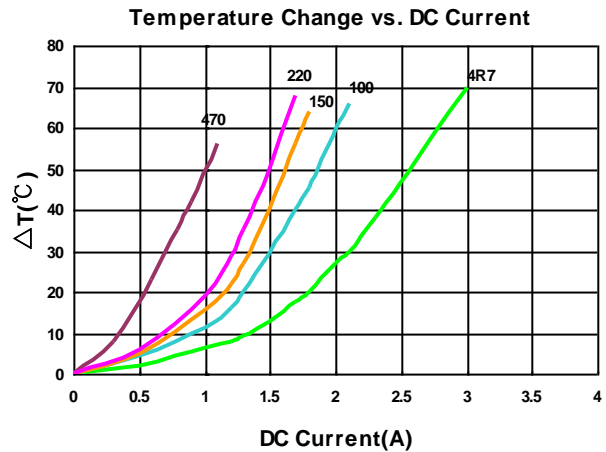
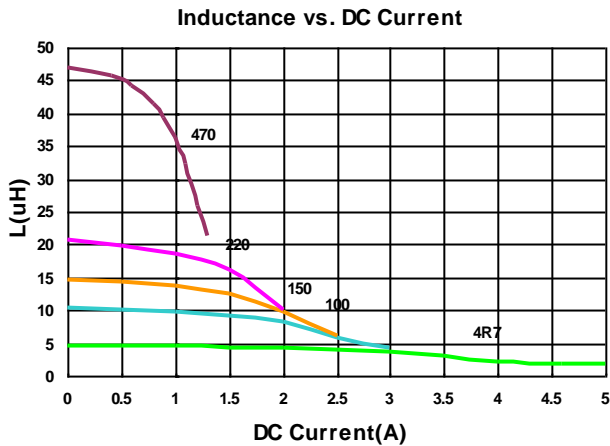

Sealed Power Inductors – BWVF Series

Electrical Characteristics

Part Number	Inductance (uH)	Tolerance (±%)	Test Frequency (kHz)	RDC (Ω) ±30%	Isat (A) Typ. (Max)	Irms (A) Typ. (Max)	Marking
BWVF006060281R0□00	1.0	20, 30	100	0.012	7.9(7.11)	6.3(5.67)	1R0
BWVF006060281R5□00	1.5	20, 30	100	0.015	7.0(6.30)	5.5(4.95)	1R5
BWVF006060282R2□00	2.2	20, 30	100	0.020	6.0(5.40)	5.0(4.50)	2R2
BWVF006060284R7□00	4.7	20, 30	100	0.036	4.0(3.60)	3.4(3.06)	4R7
BWVF006060286R8□00	6.8	20, 30	100	0.048	3.2(2.88)	3.0(2.70)	6R8

Note: When ordering, please specify tolerance code. Tolerance: M=±20% , T =±30%

- Operating temperature range - 55°C ~ 125°C(Including self - temperature rise)
- Isat for Inductance drop 30% from its value without current
- I rms for a 40°C temperature rise from 25°C ambient with current
- Measure Equipment :
- L : Agilent HP4284A+Agilent HP42841A, 100kHz 1V
- RDC : DIGITAL MILLINHM METER CHROMA 16502, or equivalent
- Isat & I rms : Agilent HP4284A

Test Instruments : HP4284A Material/Impedance Analyzer

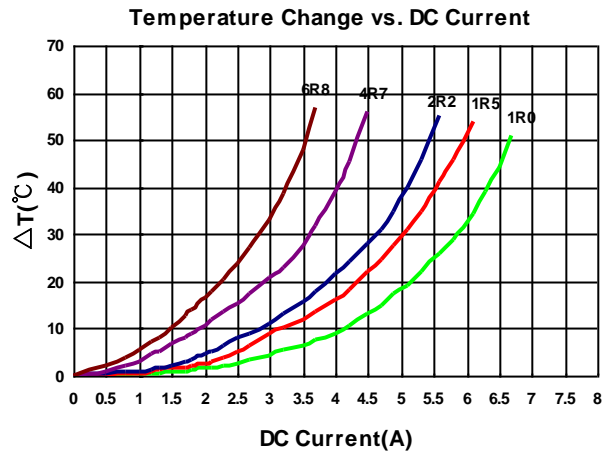
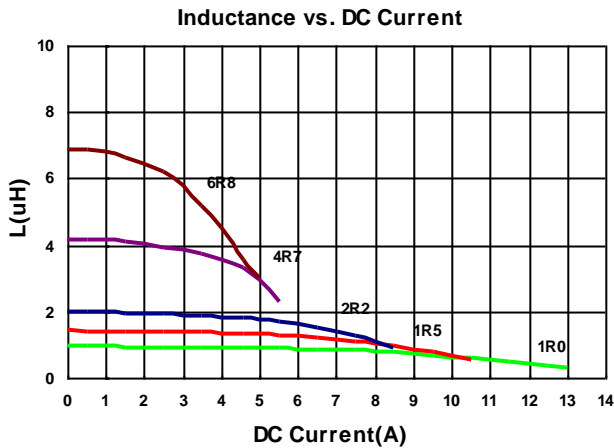

Please be sure to request approval specifications that provide further details of the products. Kindly note that the content of these specifications are subject to change or may be discontinued without prior notice. This product may not be designed/used in medical or high risk applications without Chilisin approval. Please contact our sales department before ordering.

Sealed Power Inductors – BWVF Series

Electrical Characteristics

Part Number	Inductance (uH)	Tolerance (±%)	Test Frequency (kHz)	RDC (Ω) ±30%	Isat (A) Typ. (Max)	Irms (A) Typ. (Max)	Marking
BWVF008080404R7□00	4.7	20, 30	100	0.020	6.8(6.12)	5.5(4.95)	4R7
BWVF00808040100□00	10	20, 30	100	0.038	5.0(4.50)	3.8(3.42)	100
BWVF00808040150□00	15	20, 30	100	0.057	4.0(3.60)	3.2(2.88)	150
BWVF00808040220□00	22	20, 30	100	0.082	3.4(3.06)	2.7(2.43)	220

Note: When ordering, please specify tolerance code. Tolerance: M=±20% , T =±30%

- Operating temperature range - 55°C ~ 125°C(Including self - temperature rise)
- Isat for Inductance drop 30% from its value without current
- I rms for a 40°C temperature rise from 25°C ambient with current
- Measure Equipment :
- L : Agilent HP4284A+Agilent HP42841A, 100kHz 1V
- RDC : DIGITAL MILLINHM METER CHROMA 16502, or equivalent
- Isat & I rms : Agilent HP4284A

Test Instruments : HP4284A Material/Impedance Analyzer

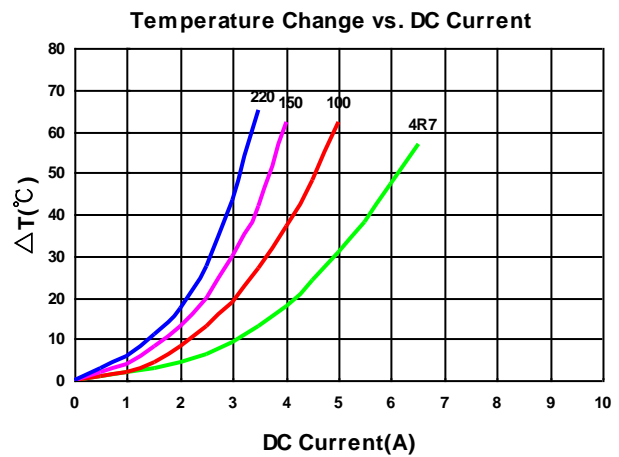
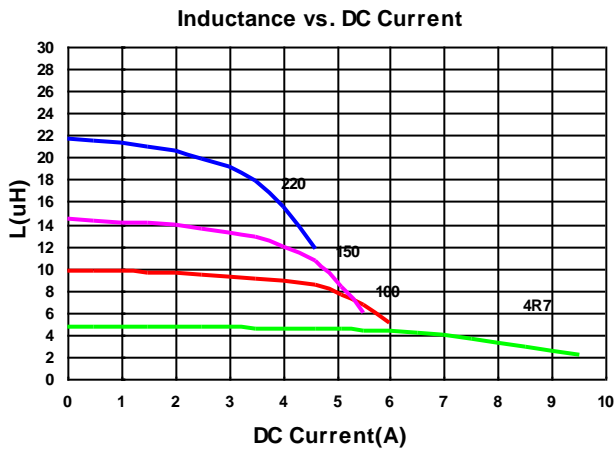

Please be sure to request approval specifications that provide further details of the products. Kindly note that the content of these specifications are subject to change or may be discontinued without prior notice. This product may not be designed/used in medical or high risk applications without Chilisin approval. Please contact our sales department before ordering.

Sealed Power Inductors – BWVF Series

Packaging Specifications

Tape Dimensions

Figure 1

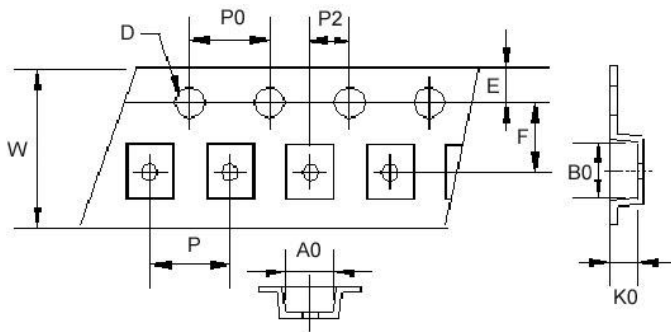

Tape Dimensions

Figure 2

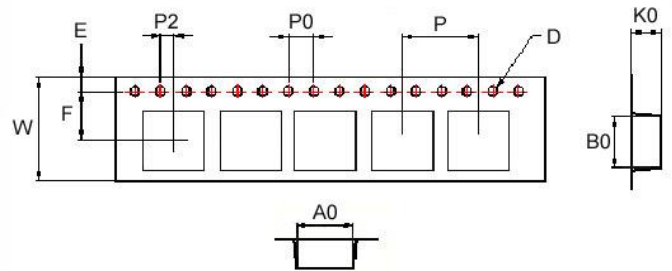

Reel Dimensions

Figure 1

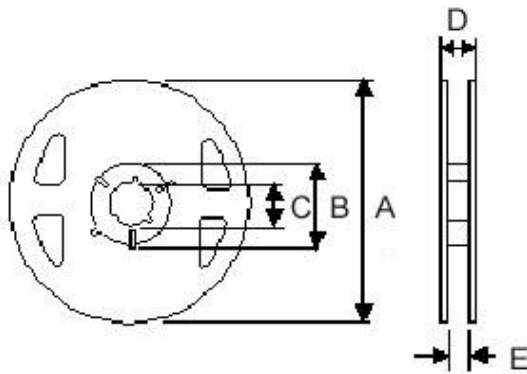

Reel Dimensions

Figure 2

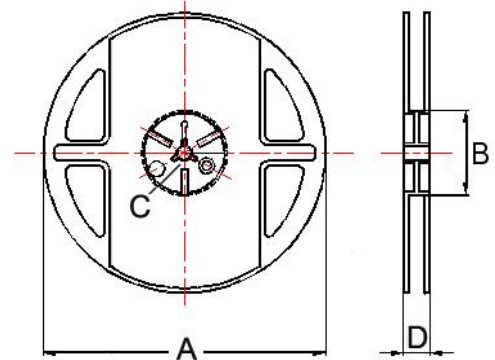

Dimensions in mm

TYPE	Fig	Tape Dimensions										Reel Dimensions					Quantity PCS / Reel
		A0	B0	K0	D	E	F	W	P	P0	P2	A	B	C	D	E	
BWVF00201B12	1	1.90	2.20	1.30	1.55	1.75	3.5	8	4	4	2	180	60	13	14.4	8.4	2000
BWVF00252A10	1	2.40	2.70	1.15	1.55	1.75	3.5	8	4	4	2	180	60	13	14.4	8.4	2000
BWVF00252A12	1	2.40	2.70	1.35	1.55	1.75	3.5	8	4	4	2	180	60	13	14.4	8.4	2000
BWVF00303010	1	3.20	3.20	1.40	1.55	1.75	3.5	8	4	4	2	180	60	13	14.4	8.4	2000
BWVF00303012	1	3.20	3.20	1.40	1.55	1.75	3.5	8	4	4	2	180	60	13	14.4	8.4	2000
BWVF00303015	1	3.15	3.15	1.60	1.55	1.75	3.5	8	4	4	2	180	60	13	14.4	8.4	2000
BWVF00404012	2	4.25	4.25	1.30	1.55	1.75	5.5	12	8	4	2	178	60	13	13.2	-	1000
BWVF00404015	2	4.25	4.25	1.70	1.55	1.75	5.5	12	8	4	2	178	60	13	13.2	-	1000
BWVF00404018	2	4.25	4.25	2.10	1.55	1.75	5.5	12	8	4	2	178	60	13	13.2	-	800
BWVF00404026	2	4.25	4.25	3.00	1.55	1.75	5.5	12	8	4	2	178	60	13	13.2	-	500
BWVF00505020	2	5.25	5.25	2.20	1.55	1.75	5.5	12	8	4	2	330	100	13	13.4	-	2000
BWVF00606020	2	6.25	6.25	2.20	1.55	1.75	5.5	12	8	4	2	330	100	13	13.4	-	2000
BWVF00606028	2	6.25	6.25	3.00	1.55	1.75	7.5	16	12	4	2	330	100	13	16.0	-	1500
BWVF00808040	2	8.25	8.25	4.15	1.55	1.75	7.5	16	12	4	2	330	100	13	16.0	-	1000