

**SERIES:** V78-1500 | **DESCRIPTION:** NON-ISOLATED SWITCHING REGULATOR

**FEATURES**

- 1.5 A current output
- extremely high efficiency up to 95%
- no heat sink required
- pin compatible to LM78XX linear regulators
- available in straight and right angle SIP packages
- low ripple and noise
- short circuit protection, thermal shutdown
- wide temperature (-40~85°C)

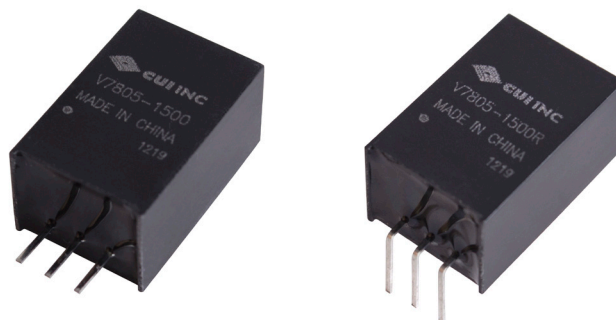

**MODEL**

MODEL	input voltage		output voltage	output current	ripple and noise <sup>1</sup>	efficiency	
	typ (Vdc)	range (Vdc)	(Vdc)	max (mA)	max (mVp-p)	Vin min (%)	Vin max (%)
V7803-1500	12	4.75~18	3.3	1,500	45	91	88
V7805-1500	12	6.5~18	5	1,500	45	93	91
V7806-1500	12	8~18	6.5	1,500	45	95	93

Notes: 1. ripple and noise are measured at 20 MHz BW.

**PART NUMBER KEY**

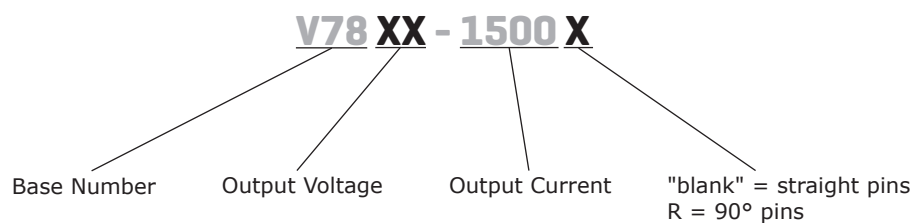

## INPUT

parameter	conditions/description	min	typ	max	units
operating input voltage	3.3 V output	4.75	12	18	Vdc
	5 V output	6.5	12	18	Vdc
	6.5 V output	8	12	18	Vdc

## OUTPUT

parameter	conditions/description	min	typ	max	units
line regulation	Vin = min ~ max, at full load		±0.5	±0.75	%
load regulation	measured from 10% load to full load		±0.5	±1.0	%
voltage accuracy	100% load		±2	±3	%
switching frequency	100% load, input voltage range	300	340	380	kHz
temperature coefficient			±0.02		%/°C

## PROTECTIONS

parameter	conditions/description	min	typ	max	units
short circuit protection	continuous, automatic recovery				
thermal shutdown			150		°C

## SAFETY AND COMPLIANCE

parameter	conditions/description	min	typ	max	units
EMI/EMC	EN 55022 class B, EN 61000-4-2 class A				
MTBF		2,000,000			hours
RoHS	2011/65/EU				

## ENVIRONMENTAL

parameter	conditions/description	min	typ	max	units
operating temperature		-40		85	°C
storage temperature		-55		125	°C
case temperature				100	°C
storage humidity	non-condensing			95	%
temperature rise	at full load		25		°C
lead temperature	1.5 mm from case for 10 seconds			300	°C

## DERATING CURVES

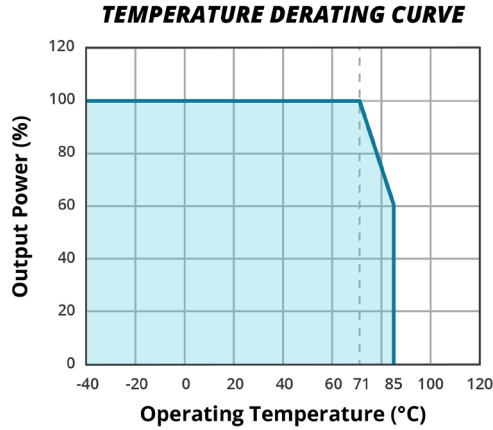

## MECHANICAL

parameter	conditions/description	min	typ	max	units
dimensions	0.689 x 0.354 x 0.453 (11.50 x 9.00 x 17.50 mm)				inch
case material	plastic (UL94-V0)				
weight			4.0		g

## MECHANICAL DRAWING

units: mm [inches]  
 tolerance:  $\pm 0.25$  [ $\pm 0.010$ ]  
 pin section tolerance:  $\pm 0.10$  mm [ $\pm 0.004$ ]

V78XX-1500

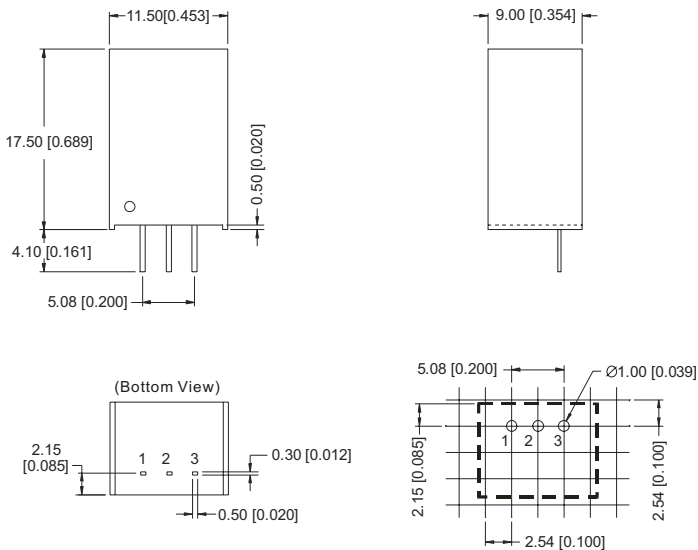

V78XX-1500R

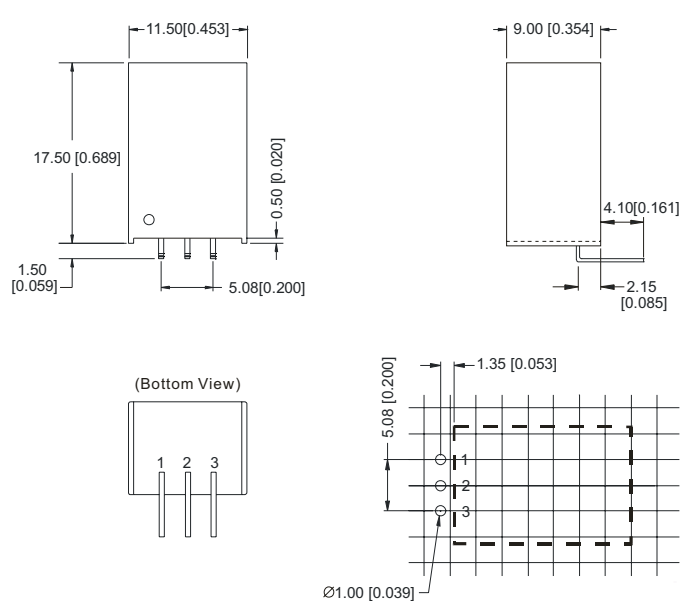

PIN CONNECTIONS	
PIN	FUNCTION
1	+Vin
2	GND
3	+Vo

## EXTERNAL CAPACITOR TABLE

Part Number	C1 (Ceramic capacitor)	C2 (Ceramic capacitor)
V7803-1500	10 $\mu$ F/25V	22 $\mu$ F/6.3V
V7805-1500	10 $\mu$ F/25V	22 $\mu$ F/16V
V7806-1500	10 $\mu$ F/25V	22 $\mu$ F/16V

## TYPICAL APPLICATION CIRCUIT

### Positive Output

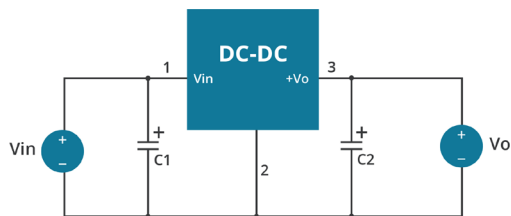

### Negative Output

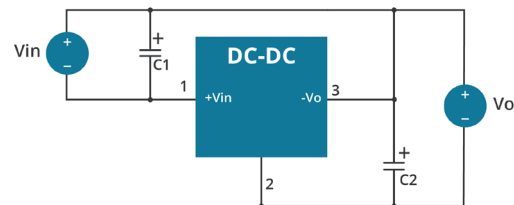

## APPLICATION EXAMPLE

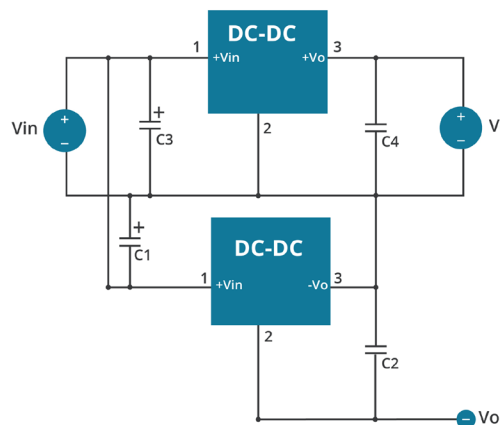

Note:

1. C1 and C2 are required and should be fitted close to the converter pins.
2. The capacitance of C1 and C2 sees external capacitor table, it can be increased properly if required, and tantalum or low ESR electrolytic capacitors may also suffice.
3. No parallel connection or plug and play.

## INPUT FILTER CIRCUIT

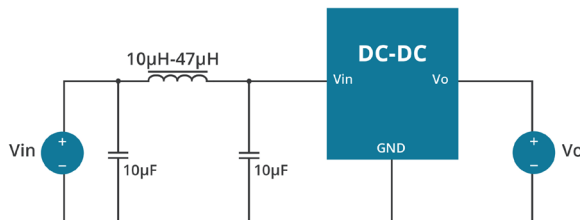

## OUTPUT FILTER CIRCUIT

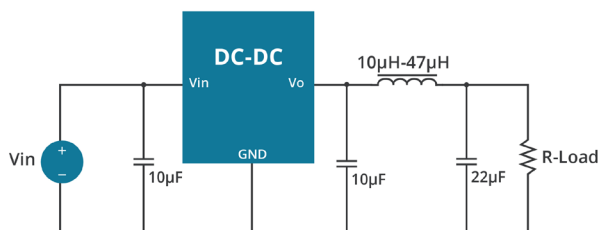

## EMC RECOMMENDED CIRCUIT

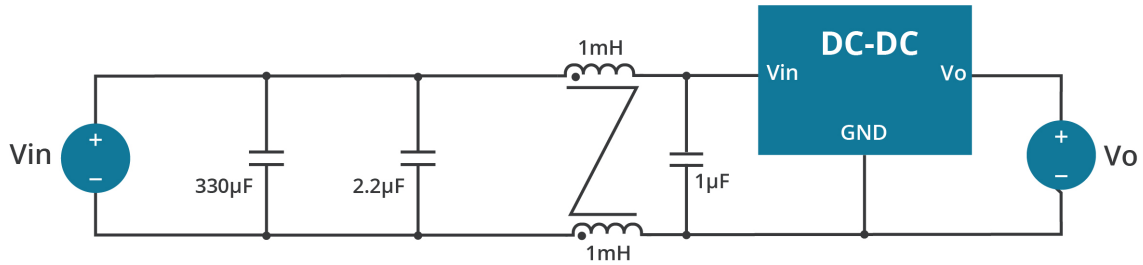

## TEST CONFIGURATION

### Efficiency and Output Voltage Ripple Test

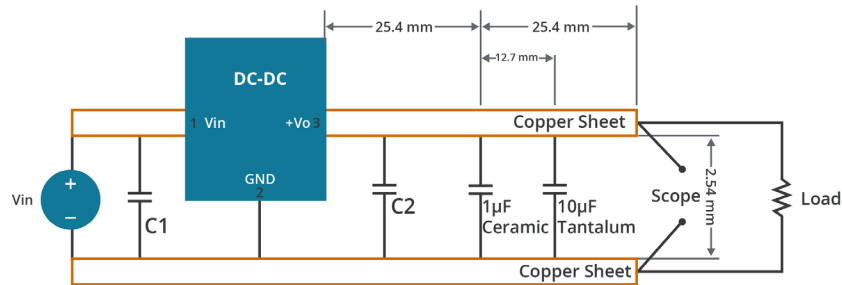

### Start-up and Load Transient Response Test

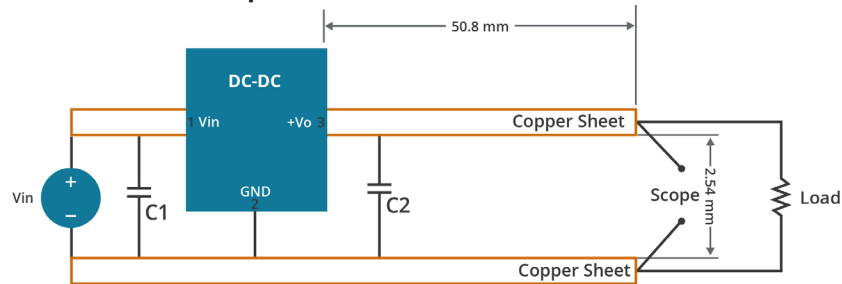

## EFFICIENCY AND RIPPLE CURVES

**EFFICIENCY VS INPUT VOLTAGE (full load)**

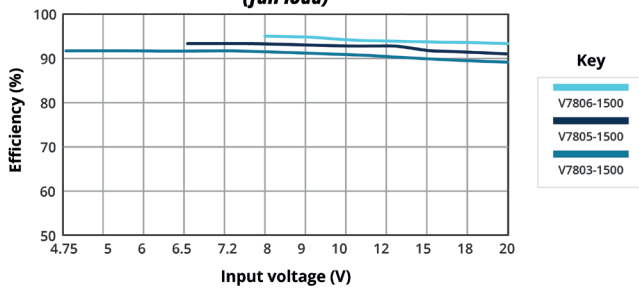

**RIPPLE VS OUTPUT LOAD (nominal Vin)**

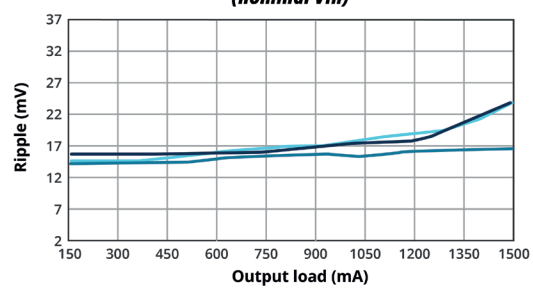

**EFFICIENCY VS INPUT VOLTAGE (full load)**

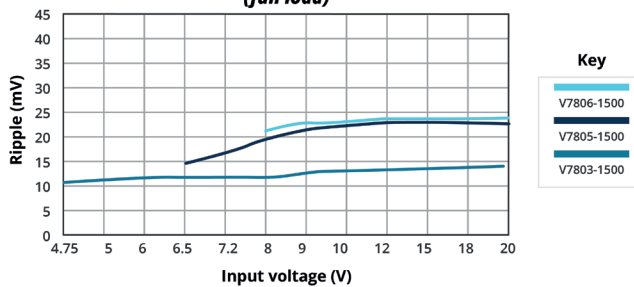

**RIPPLE VS OUTPUT LOAD (nominal Vin)**

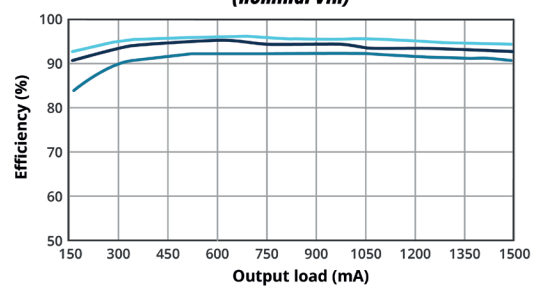

## REVISION HISTORY

rev.	description	date
1.0	initial release	07/16/2010
1.01	V-Infinity branding removed	09/04/2012
1.02	updated typical application circuits	09/25/2012
1.03	discontinued model V7802-1500	03/21/2014
1.04	updated datasheet	06/06/2016
1.05	company logo updated	04/14/2021
1.06	derating curve, efficiency curves and circuit figures updated	09/22/2021

The revision history provided is for informational purposes only and is believed to be accurate.



**CUI INC**  
a bel group

**Headquarters**  
20050 SW 112th Ave.  
Tualatin, OR 97062  
**800.275.4899**

Fax 503.612.2383  
**cui.com**  
techsupport@cui.com

CUI offers a two (2) year limited warranty. Complete warranty information is listed on our website.

CUI reserves the right to make changes to the product at any time without notice. Information provided by CUI is believed to be accurate and reliable. However, no responsibility is assumed by CUI for its use, nor for any infringements of patents or other rights of third parties which may result from its use.

CUI products are not authorized or warranted for use as critical components in equipment that requires an extremely high level of reliability. A critical component is any component of a life support device or system whose failure to perform can be reasonably expected to cause the failure of the life support device or system, or to affect its safety or effectiveness.