

**SERIES:** VF-D320-DXXA-CFS | **DESCRIPTION:** AC-DC POWER SUPPLY

**FEATURES**

- up to 300 W continuous power
- metal top cover and side fan
- passive power correction
- dual outputs
- power good signal
- 3000 Vac isolation voltage
- over load, over voltage, over temperature, and short circuit protections
- IEC/EN/U 62368 certified
- efficiency up to 75%



MODEL	output voltage	output current	output <sup>1</sup> power	ripple and noise <sup>2,3</sup>	efficiency
	(Vdc)	max (A)	max (W)	max (mVp-p)	typ (%)
VF-D320-D512A-CFS*	5 12	30 16.67	250	50 120	75%
VF-D320-D524A-CFS*	5 24	30 8.33	250	50 240	75%
VF-D320-D548A-CFS*	5 48	30 4.16	250	50 480	75%
VF-D320-D1224A-CFS	12 24	16.67 8.33	300	120 240	75%

Notes:

1. Maximum combined power.
2. 10% minimum load is required to maintain the ripple and regulation.
3. Ripple and noise is measured from 10 KHz to 20 MHz at output terminals with a 0.1  $\mu$ F ceramic capacitor and a 22  $\mu$ F electrolytic capacitor in parallel.
4. \* Discontinued model.

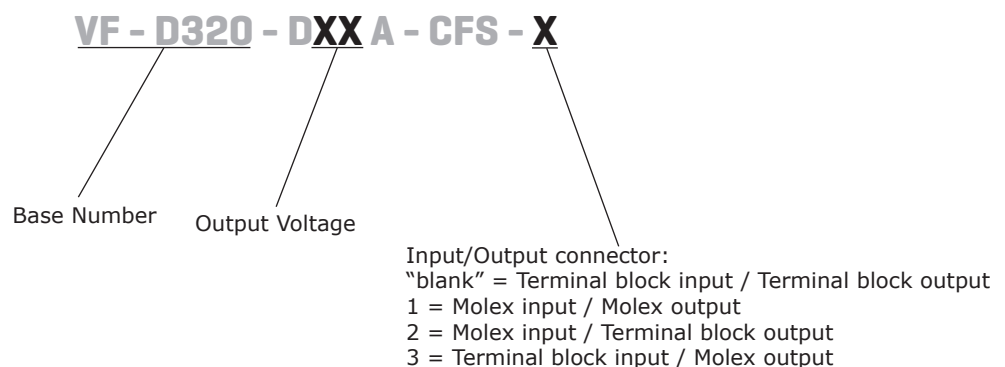
**PART NUMBER KEY**

## INPUT

parameter	conditions/description	min	typ	max	units
voltage	90-132/180-264 auto selectable	90/180		132/264	Vac
frequency		47		63	Hz
current	at 100-120 Vac, cold start at 200-240 Vac, cold start			8 4	A A
inrush current	at 115 Vac, full load, cold start at 230 Vac, full load, cold start			35 70	A A
power factor	Compliant to EN61000-3-2 class A				

## OUTPUT

parameter	conditions/description	min	typ	max	units
line regulation	low line to high line		±5		%
load regulation	all other outputs		±5		%
temperature coefficient			0.25		mV/°C
transient response	Output voltage returns to within 1% in less than 2.5 mS for a 50% load change. Peak transient does not exceed 5%.				
start-up time	At 120 Vac			1	s
hold-up time	At 120 Vac and 80% of rated maximum load	20			ms
adjustability	Adjustable with built-in trim pot.		±5		%
power good	Designated as PG on the CN1. This signal goes high 100-500 mS after the output reaches regulation. It goes low at least 1 mS before loss of regulation.				
fan drive	12 Vdc / 400 mA for external fan				

## PROTECTIONS

parameter	conditions/description	min	typ	max	units
over voltage protection	AC input needs to be reset to restart the power supply.			130	%
over current protection	Foldback mode, automatically recovers		110	140	%
short circuit protection	Short circuit can be continuous. Recovers automatically upon removal of short.				
over temp. protection	Auto recovery	85			°C

## SAFETY & COMPLIANCE

parameter	conditions/description	min	typ	max	units
isolation voltage	Applied for 3 seconds at 10 mA max. Primary to secondary: Primary to transformer core: Primary to earth chassis:	3,000 1,500 1,500			Vac Vac Vac
safety approvals	certified to 62368: IEC/EN/U				
EMI/EMC	Pass FCC Part 15, CISPR 22 class B, Conducted				
leakage current	at 240 Vac at 120 Vac			500 300	µA µA
RoHS compliant	yes				
MTBF	According to MIL-HDBK-217 at 30 °C	100,000			hrs

## ENVIRONMENTAL

parameter	conditions/description	min	typ	max	units
operating temperature	see derating curve	0		70	°C
storage temperature		-20		85	°C
operating humidity	non-condensing	5		90	%
storage humidity	non-condensing	5		95	%
vibration	Acceleration $\pm 7.35$ M/(SxS), on X, Y and Z Axis	5		50	Hz

## DERATING CURVES

**TEMPERATURE DERATING CURVE**

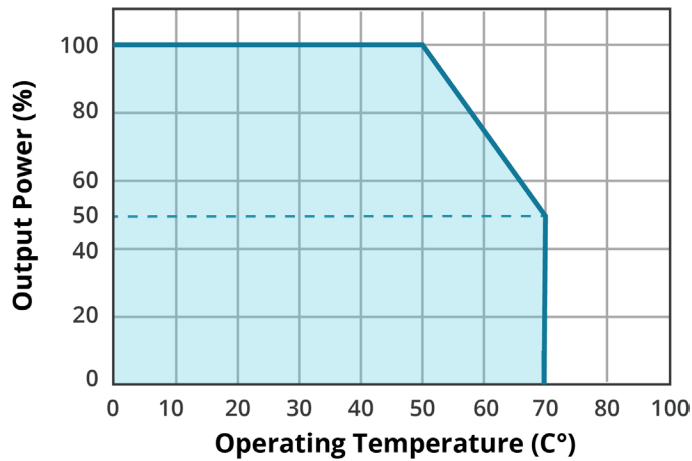

# MECHANICAL DRAWING

units: mm[inches]

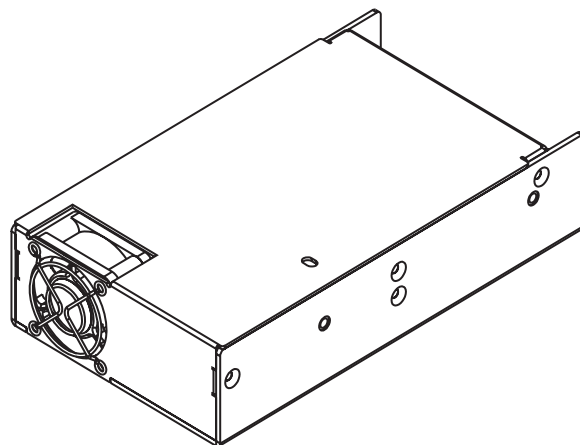
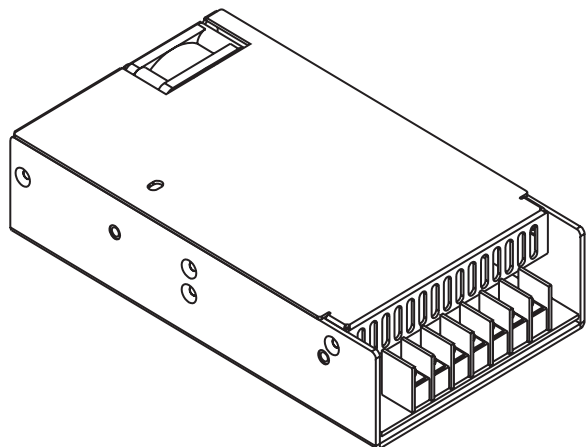

CN1	
1	ground
2	ac neutral
3	ac line

CN2	
1	Vo1
2	Vo1
3	Vo1
4	RTN
5	RTN
6	RTN
7	RTN
8	RTN
9	Vo2
10	Vo2

CN3	
1	power good
2	RTN
3	fan fail

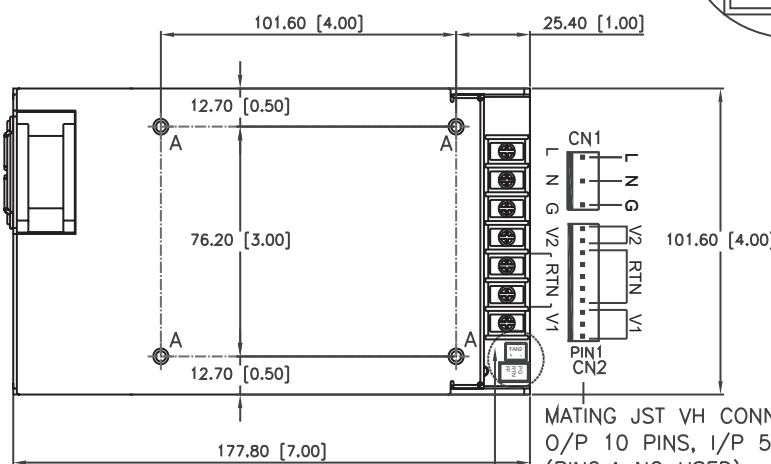
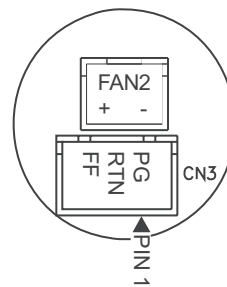
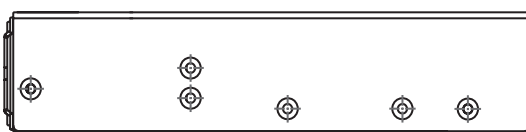

MATING JST VH CONNECTOR  
 O/P 10 PINS, I/P 5 PINS USE 3 PIN  
 (PIN2,4 NO USED)

TERMINAL BLOCK  
 M3.5 SCREW 7PINS 9.5mm CENTER

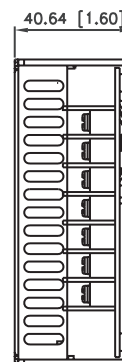

A 4:1 (8X)Zn-PLATED

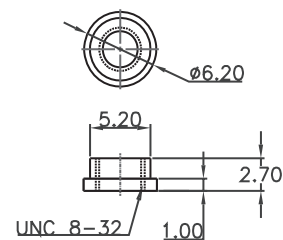
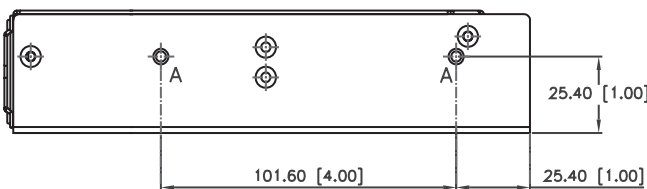

- Notes:
- CN1 mates with JST VH series 5-pin connector
  - CN2 mates with JST VH series 10-pin connector
  - CN3 mates with molex part no. JST XHP-3 or equivalent (CHYAO SHIUNN JS-2001-03) and JST SXH-002T-P0.6 mating pins
  - Fan drive connector mates with JST part no. XHP-2 or equivalent (CHYAO SHIUNN JS-2001-02).
  - Mounting hole max depth 4.00mm

## REVISION HISTORY

rev.	description	date
1.0	initial release	05/5/2009
1.01	new template applied	12/17/2011
1.02	V-Infinity branding removed	08/28/2012
1.03	removed on/off information, removed low leakage option, updated spec	05/08/2013
1.04	safeties updated	11/10/2020
1.05	derating curve updated	04/22/2021
1.06	discontinued model VF-D320-D548A-CFS	01/10/2022
1.07	discontinued models VF-D320-D512A-CFS & VF-D320-D524A-CFS	06/02/2022

The revision history provided is for informational purposes only and is believed to be accurate.



# CUI INC

a bel group

**Headquarters**  
20050 SW 112th Ave.  
Tualatin, OR 97062  
**800.275.4899**

Fax 503.612.2383  
**cui.com**  
techsupport@cui.com

CUI offers a two (2) year limited warranty. Complete warranty information is listed on our website.

CUI reserves the right to make changes to the product at any time without notice. Information provided by CUI is believed to be accurate and reliable. However, no responsibility is assumed by CUI for its use, nor for any infringements of patents or other rights of third parties which may result from its use.

CUI products are not authorized or warranted for use as critical components in equipment that requires an extremely high level of reliability. A critical component is any component of a life support device or system whose failure to perform can be reasonably expected to cause the failure of the life support device or system, or to affect its safety or effectiveness.