

**SERIES:** VQA3-S | **DESCRIPTION:** IGBT DRIVER DC-DC

**FEATURES**

- designed for IGBT driver applications
- reinforced insulation
- CMTI > 200 kV/μs
- ultra-low isolation capacitance: 3.5pF ( typ.)
- -40 ~ 105°C temperature range
- continuous short circuit protection
- UL/cUL 62368 certified



**MODEL**

MODEL	input voltage		output voltage (Vdc)	output current max (mA)	ripple and noise <sup>1</sup> max (mVp-p)	efficiency typ (%)
	typ (Vdc)	range (Vdc)				
VQA3-S5-D15-S	5	4.5~5.5	15 -8.7	80 -40	150	82
VQA3-S12-D15-S	12	10.8~13.2	15 -9.0	100 -100	100	87
VQA3-SX12-D15-S	12	9.0~15.0	15 -9.0	100 -100	100	87
VQA3-S15-D15-S	15	13.5~16.5	15 -9.0	100 -100	100	87
VQA3-S24-D15-S	24	21.6~26.4	15 -9.0	100 -100	100	82

Notes: 1. Ripple and noise are measured at 20 MHz BW by "parallel cable" method. See application notes.

**PART NUMBER KEY**

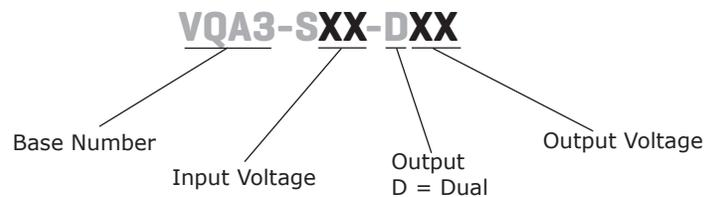

## INPUT

parameter	conditions/description	min	typ	max	units
surge voltage <sup>2</sup>	5 Vdc input model	-0.7		9	Vdc
	12 Vdc input model	-0.7		18	Vdc
	15 Vdc input model	-0.7		21	Vdc
	24 Vdc input model	-0.7		30	Vdc
temperature coefficient	at full load		±0.04	±0.1	%/°C

Note: 2. For 1 second maximum.

## OUTPUT

parameter	conditions/description	min	typ	max	units
capacitive load	5 Vdc input model			1,000	μF
	all other input models			2,200	μF
line regulation	5 Vdc input model		1.1	1.4	%
	all other input models		1.1	1.5	%
load regulation <sup>3</sup>	5 Vdc input model	+Vo output	8	15	%
		-Vo output	10	15	%
	all other input models	+Vo output	6	15	%
		-Vo output	8	15	%
switching frequency	at full load, nominal input		200		kHz

Note: 3. At 10 ~ 100% load

## PROTECTIONS

parameter	conditions/description	min	typ	max	units
short circuit protection	continuous, auto-recovery				
CMTI	input to output	±200			kV/μs

## SAFETY AND COMPLIANCE

parameter	conditions/description	min	typ	max	units
isolation voltage	input to output for 1 minute, 1 mA max	5,600			Vdc
continuous withstand voltage	input to output according to IEC 61800-5-1	1,700			V
isolation resistance	input to output at 500 Vdc	1,000			MΩ
isolation capacitance	input to output, 100 kHz/0.1 V		3.5	5	pF
safety approvals	certified to 62368: UL/cUL designed to meet 62368: EN/IEC				
conducted emissions	CISPR32/EN55032 CLASS A, CISPR32/EN55032 CLASS B (see recommended circuit)				
radiated emissions	CISPR32/EN55032 CLASS A, CISPR32/EN55032 CLASS B (see recommended circuit)				
ESD	5 Vdc input models: IEC/EN 61000-4-2 Contact ±6kV, perf. Criteria B other models: IEC/EN 61000-4-2 Contact ±8kV, perf. Criteria B				
MTBF	as per MIL-HDBK-217F at 25°C	3,500,000			hours
RoHS	yes				

## ENVIRONMENTAL

parameter	conditions/description	min	typ	max	units
operating temperature	see derating curve	-40		105	°C
storage temperature		-55		125	°C
storage humidity	non-condensing	5		95	%

## SOLDERABILITY

parameter	conditions/description	min	typ	max	units
pin soldering resistance temperature	1.5mm from case for 10 seconds			300	°C

## MECHANICAL

parameter	conditions/description	min	typ	max	units
dimensions	19.50 x 9.80 x 12.5 (0.768 x 0.386 x 0.492 inch)				mm
material	plastic, flame retardant and heat resistant				
weight			4.3		g
cooling method	natural convection				

## MECHANICAL DRAWING

units: mm [inches]  
 tolerance:  $\pm 0.50$  [ $\pm 0.020$ ]  
 pin section tolerance:  $\pm 0.10$  [ $\pm 0.004$ ]

PIN CONNECTIONS	
PIN	FUNCTION
1	Vin
2	GND
5	-Vo
6	0V
7	+Vo

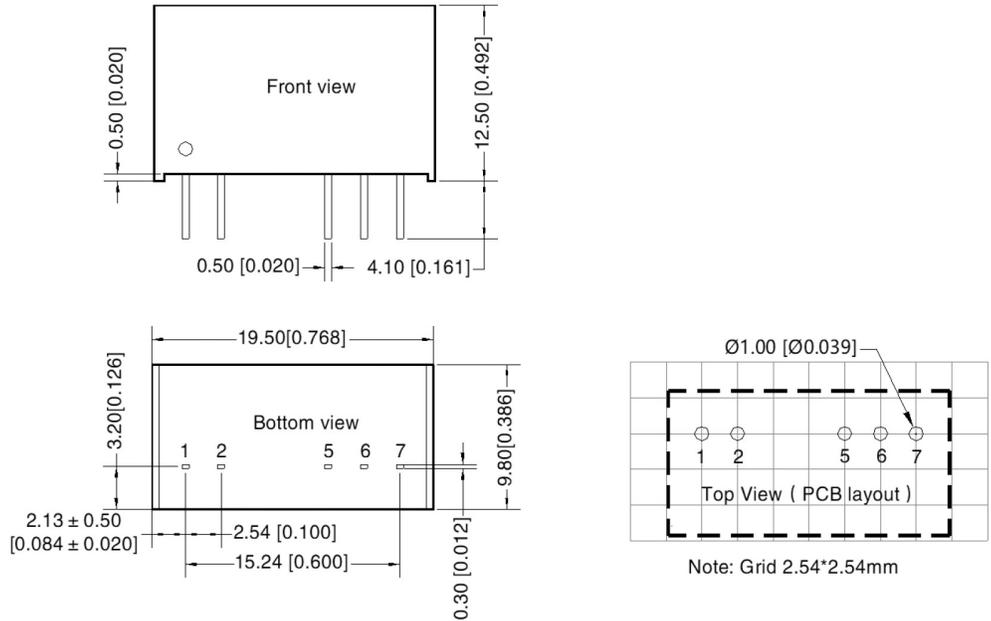

## DERATING CURVES

**TEMPERATURE DERATING CURVE**  
 (5 Vdc input model)

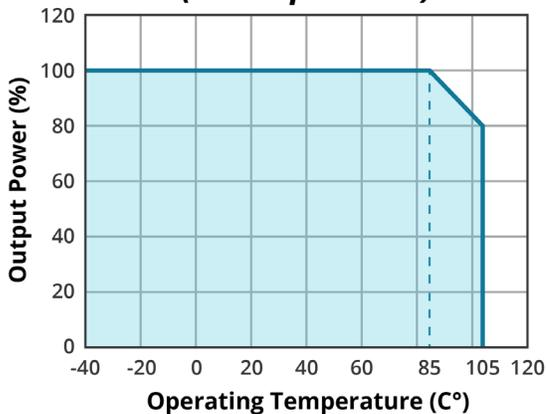

**TEMPERATURE DERATING CURVE**  
 (all other input models)

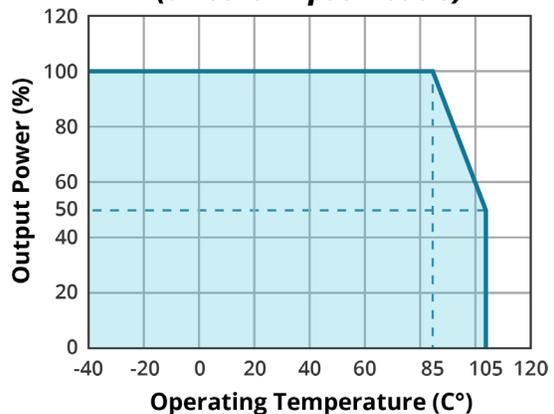

## REGULATION CURVES

**OUTPUT REGULATION CURVE**  
**VQA3-S5-D15-S**  
**(+Vo)**

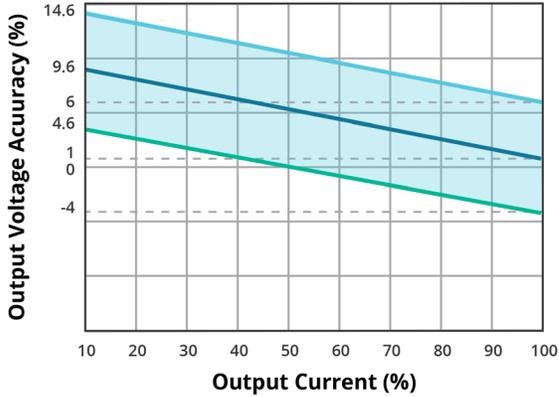

**OUTPUT REGULATION CURVE**  
**VQA3-S5-D15-S**  
**(-Vo)**

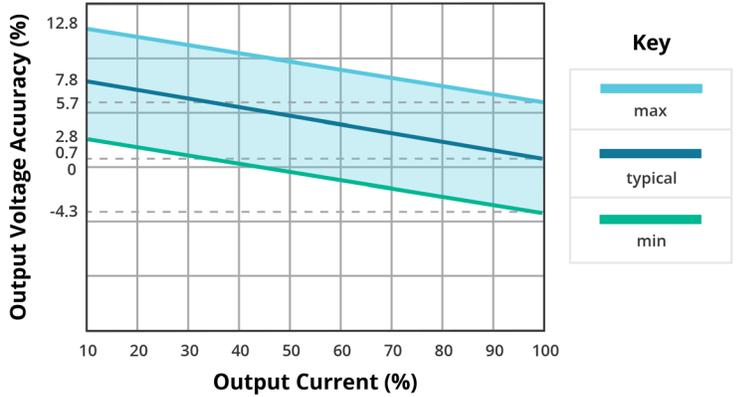

**OUTPUT REGULATION CURVE**  
**VQA3-S12-D15-S**  
**(+Vo)**

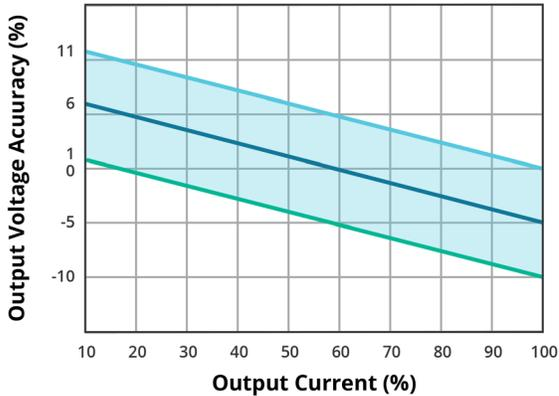

**OUTPUT REGULATION CURVE**  
**VQA3-S12-D15-S**  
**(-Vo)**

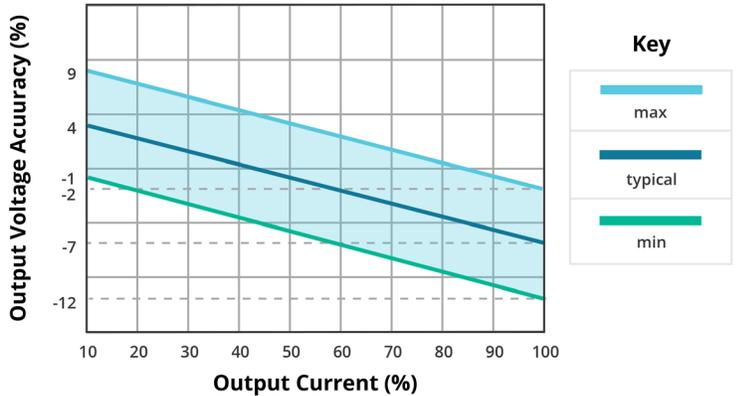

**OUTPUT REGULATION CURVE**  
**VQA3-S15-D15-S**  
**(+Vo)**

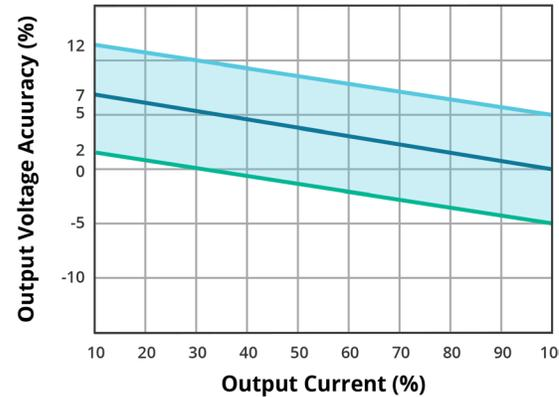

**OUTPUT REGULATION CURVE**  
**VQA3-S15-D15-S**  
**(-Vo)**

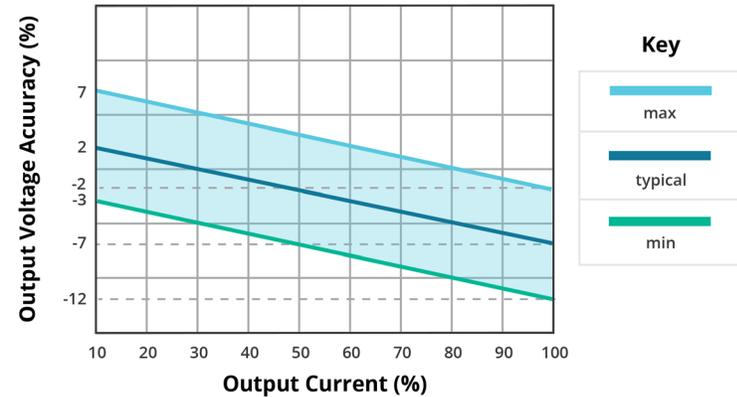

## REGULATION CURVES (CONTINUED)

**OUTPUT REGULATION CURVE**  
**VQA3-S24-D15-S**  
**(+Vo)**

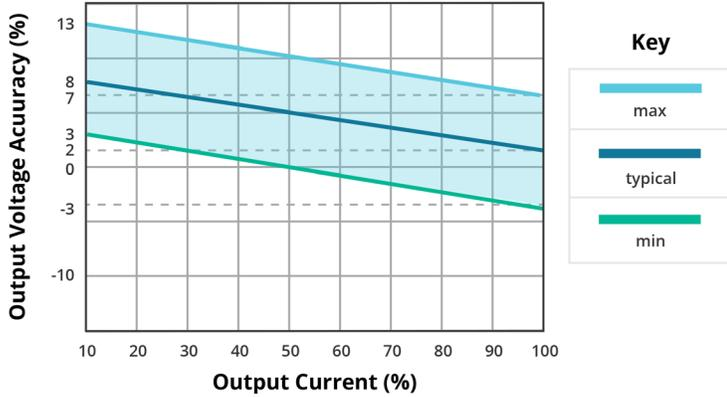

**OUTPUT REGULATION CURVE**  
**VQA3-S24-D15-S**  
**(-Vo)**

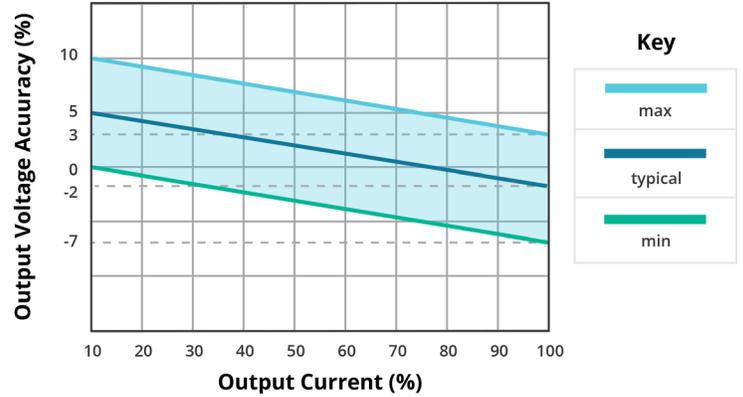

## EFFICIENCY CURVES

**EFFICIENCY VS INPUT VOLTAGE**  
**(full load)**

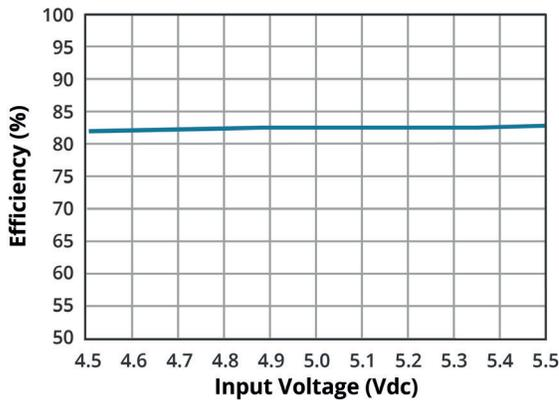

**EFFICIENCY VS OUTPUT LOAD**  
**(Vin = Vin-nominal)**

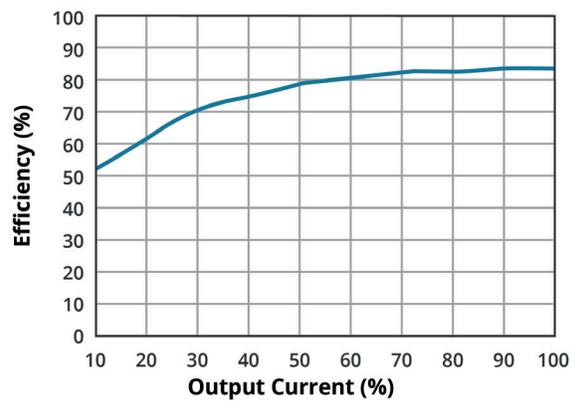

**EFFICIENCY VS INPUT VOLTAGE**  
**(full load)**

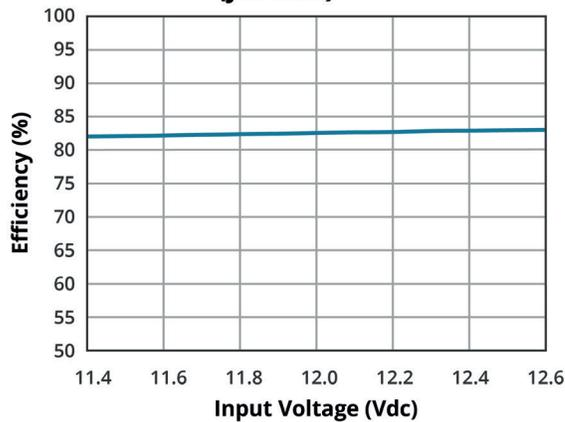

**EFFICIENCY VS OUTPUT LOAD**  
**(Vin = 12 Vdc)**

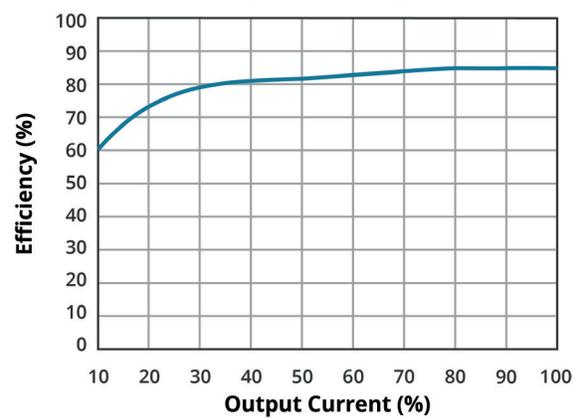

## EMC RECOMMENDED CIRCUIT

Figure 1

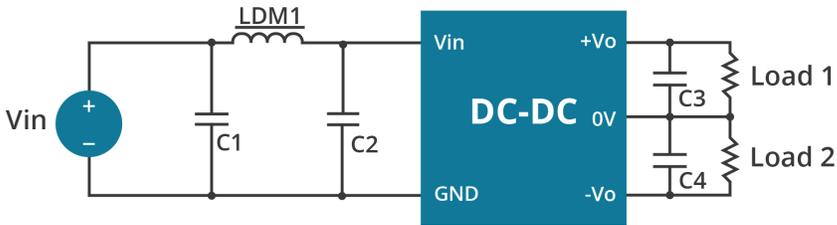

Table 1

Project	5V	12V, 15V, 24V	
EMI	C1/C2	4.7μF/16V	1μF/50V
	C3/C4	10μF/50V (low internal resistance)	100μF/30V (low internal resistance)
	LDM	6.8μH	33μH

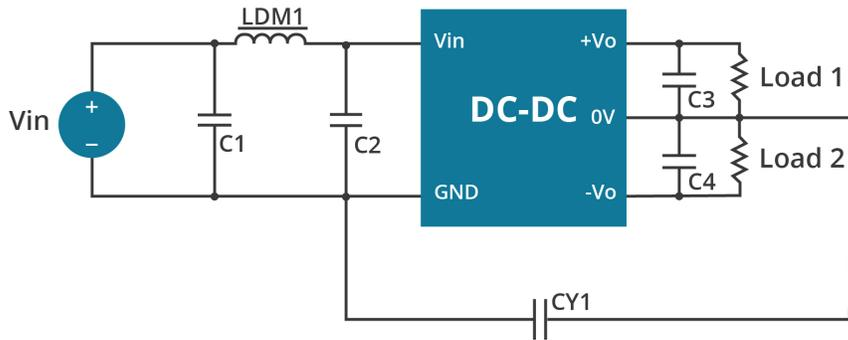
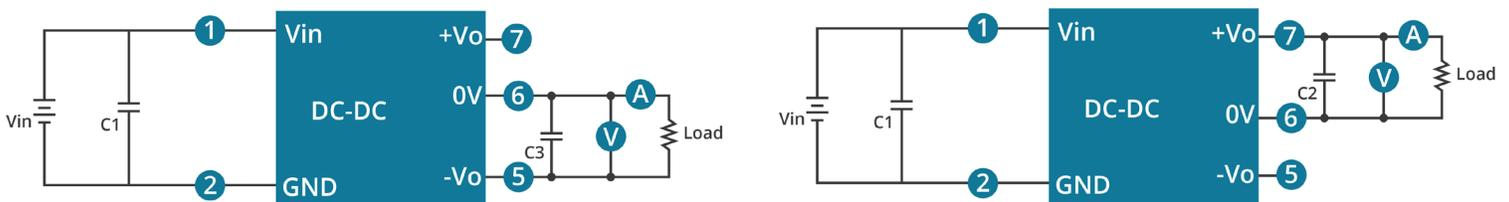

Table 2

Project	5V	
EMI	C1/C2	4.7μF/16V
	C3/C4	10μF/50V (low internal resistance)
	LDM	6.8μH
	CY1	330pF

## TEST CONFIGURATION

Figure 2



C1, C2, C3: 100 μF/35V (low resistance)

## APPLICATION CIRCUIT

Figure 3

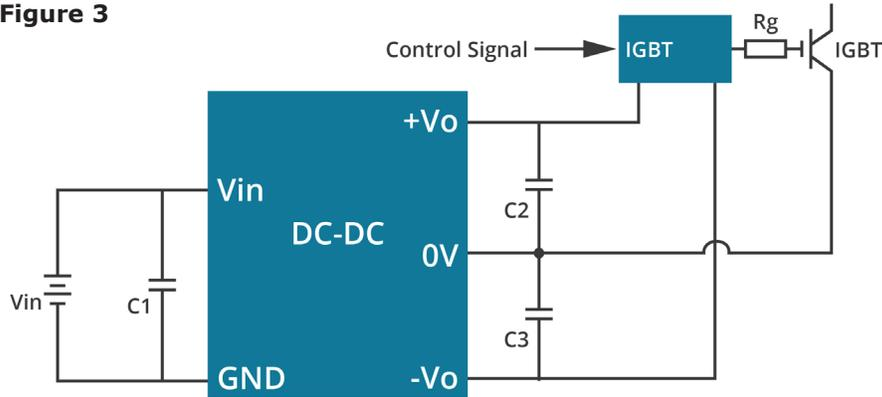

Table 3

C1/C2/C3
100μH/35V (low ESR)

- Notes:
1. The lead connecting the power supply module and IGBT driver must as short as possible.
  2. The output filtering capacitor should be connected as close as possible to the converter and the IGBT driver.
  3. The peak of the IGBT driver gate drive current is high, so low internal resistance electrolytic capacitor is recommended to be used for the power supply module output filter capacitor.
  4. The maximum capacitive load is tested at nominal input voltage and full load.
  5. Consider fixing with glue near the module if being used in vibration occasion.
  6. All specifications are measured at  $T_a=25^\circ\text{C}$ , humidity <75%, nominal input voltage and rated output load unless otherwise specified.

## REVISION HISTORY

---

rev.	description	date
1.0	initial release	10/11/2022

The revision history provided is for informational purposes only and is believed to be accurate.



**CUI INC**  
a bel group

**Headquarters**  
20050 SW 112th Ave.  
Tualatin, OR 97062  
**800.275.4899**

Fax 503.612.2383  
**cui.com**  
techsupport@cui.com

CUI offers a two (2) year limited warranty. Complete warranty information is listed on our website.

CUI reserves the right to make changes to the product at any time without notice. Information provided by CUI is believed to be accurate and reliable. However, no responsibility is assumed by CUI for its use, nor for any infringements of patents or other rights of third parties which may result from its use.

CUI products are not authorized or warranted for use as critical components in equipment that requires an extremely high level of reliability. A critical component is any component of a life support device or system whose failure to perform can be reasonably expected to cause the failure of the life support device or system, or to affect its safety or effectiveness.