

Gate Driver Providing Galvanic Isolation Series

# Isolation Voltage 2500 Vrms

# 1ch Gate Driver Providing Galvanic Isolation

## BM60059FV-C

### General Description

The BM60059FV-C is a gate driver with an isolation voltage of 2500 Vrms. It has an I/O delay time of 450 ns, minimum input pulse width of 400 ns, and incorporates the fault signal output function, under voltage lockout (UVLO) function, short circuit protection (SCP) function, active miller clamping function, temperature monitoring, switching controller function, gate constant current driving function and output state feedback function.

### Key Specifications

■ Isolation Voltage:	2500 Vrms
■ Maximum Gate Drive Voltage:	24 V
■ I/O Delay Time:	450 ns (Max)
■ Minimum Input Pulse Width:	400 ns

### Package

SSOP-B28W

### W (Typ) x D (Typ) x H (Max)

9.2 mm x 10.4 mm x 2.4 mm

### Features

- AEC-Q100 Qualified<sup>(Note 1)</sup>
- Fault Signal Output Function
- Under Voltage Lockout Function
- Short Circuit Protection Function
- Fast Turn Off Function for Short Circuit Protection
- Soft Turn Off Function for Short Circuit Protection (Adjustable turn off time)
- Active Miller Clamping
- Temperature Monitor
- Switching Controller
- Gate Constant Current Driving Function
- Output State Feedback Function
- UL1577 Recognized: File No. E356010

<sup>(Note 1)</sup> Grade1



### Applications

- Automotive Inverter System
- Automotive DCDC Converter
- Industrial Inverter System
- UPS System

### Typical Application Circuit

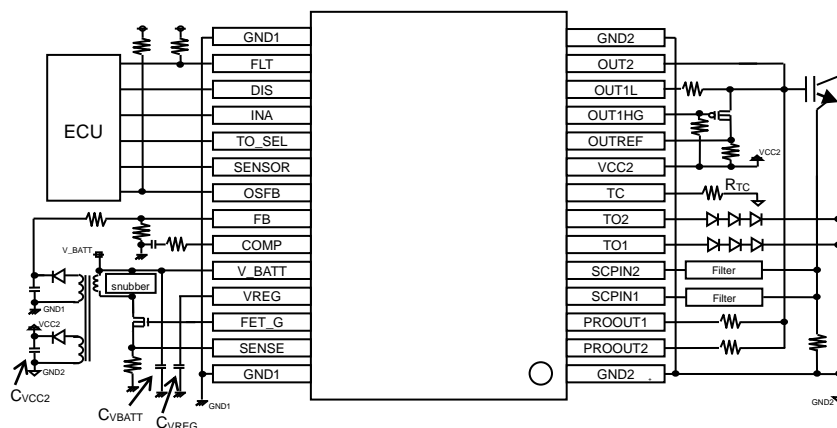

○Product structure : Silicon integrated circuit ○This product has no designed protection against radioactive rays.

## Contents

General Description .....	1
Features.....	1
Applications .....	1
Key Specifications .....	1
Package.....	1
Typical Application Circuit.....	1
Contents .....	2
Recommended Range of External Constants.....	3
Pin Descriptions.....	3
Pin Configurations .....	3
Block Diagram .....	4
Absolute Maximum Ratings .....	4
Thermal Resistance.....	5
Recommended Operating Conditions.....	5
Insulation Related Characteristics .....	5
Electrical Characteristics.....	6
Typical Performance Curves.....	9
UL1577 Ratings Table.....	27
Description of Pins and Cautions on Layout of Board.....	28
Description of Functions and Examples of Constant Setting .....	30
1. Fault Status Output .....	30
2. Under Voltage Lockout (UVLO) Function .....	30
3. Short Circuit Protection (SCP) Function.....	31
4. Miller Clamp Function .....	32
5. Gate Constant Current Driving Function .....	33
6. Output State Feedback Function.....	34
7. Switching Regulator .....	34
8. Temperature Monitor Function .....	35
9. I/O Condition Table.....	36
Selection of Components Externally Connected.....	37
I/O Equivalence Circuits.....	38
Operational Notes.....	42
Ordering Information.....	44
Marking Diagram .....	44
Physical Dimension and Packing Information .....	45
Revision History.....	46

Recommended Range of External Constants

Pin Name	Symbol	Recommended Value			Unit
		Min	Typ	Max	
TC (As Temperature monitor)	R <sub>TC</sub>	1.25	-	50	kΩ
TC (No Temperature monitor)	R <sub>TC</sub>	0.1	1	10	MΩ
V_BATT	C <sub>VBATT</sub>	3	-	-	μF
VCC2	C <sub>VCC2</sub>	0.4	-	-	μF
VREG	C <sub>VREG</sub>	0.3	1	10	μF

C<sub>VREG</sub> : For supplying gate charge current of MOS for fly back converter and driving internal transformer.

C<sub>VCC2</sub> : For supplying gate charge current of MOS FET/IGBT.

Pin Configurations

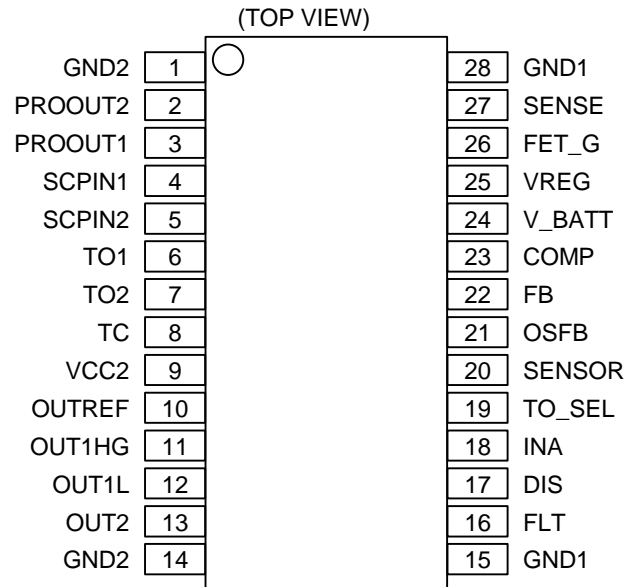

Pin Descriptions

Pin No.	Pin Name	Function
1	GND2	Output-side ground pin
2	PROOUT2	Fast turn off pin for short circuit protection
3	PROOUT1	Soft turn off pin for short circuit protection / Gate voltage input pin
4	SCPIN1	Short circuit detection pin 1
5	SCPIN2	Short circuit detection pin 2
6	TO1	Constant current output pin / Sensor voltage input pin 1
7	TO2	Constant current output pin / Sensor voltage input pin 2
8	TC	Resistor connection pin for setting constant current source output
9	VCC2	Output-side power supply pin
10	OUTREF	Reference voltage pin for constant current driving
11	OUT1HG	Source side MOS buffer driving pin
12	OUT1L	Sink side output pin
13	OUT2	Output pin for Miller Clamp
14	GND2	Output-side ground pin
15	GND1	Input-side ground pin
16	FLT	Fault output pin
17	DIS	Input enabling signal input pin
18	INA	Control input pin
19	TO_SEL	Temperature information selecting pin
20	SENSOR	Temperature information output pin
21	OSFB	Output state feedback output pin
22	FB	Error amplifier inverting input pin for switching controller
23	COMP	Error amplifier output pin for switching controller
24	V_BATT	Main power supply pin
25	VREG	Input-side internal power supply pin
26	FET_G	MOS FET for transformer drive control pin for switching controller
27	SENSE	Current feedback resistor connection pin for switching controller
28	GND1	Input-side ground pin

Block Diagram

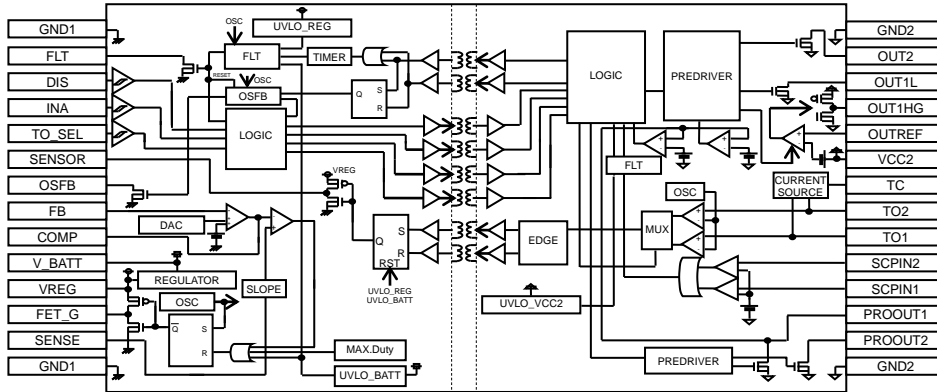

Absolute Maximum Ratings

Parameter	Symbol	Rating	Unit
Main Power Supply Voltage	$V_{BATTMAX}$	-0.3 to +40.0 <sup>(Note 2)</sup>	V
Input-side Control Block Supply Voltage	$V_{REGMAX}$	-0.3 to +7.0 <sup>(Note 2)</sup>	V
Output-side Supply Voltage	$V_{CC2MAX}$	-0.3 to +30.0 <sup>(Note 3)</sup>	V
INA, DIS, TOSEL Pin Input Voltage	$V_{INMAX}$	-0.3 to +7.0 <sup>(Note 2)</sup>	V
FLT, OSFB Pin Input Voltage	$V_{FLTMAX}$	-0.3 to +7.0 <sup>(Note 2)</sup>	V
FLT, OSFB Pin Output Current	$I_{FLT}$	10	mA
SENSOR Pin Output Current	$I_{SENSOR}$	10	mA
FB Pin Input Voltage	$V_{FBMAX}$	-0.3 to $V_{BATT} + 0.3$ or + 4.3 <sup>(Note 2)</sup>	V
FET_G Pin Output Current (Peak 5 $\mu$ s)	$I_{FET\_GPEAK}$	1	A
SCPIN1, SCPIN2 pin Input Voltage	$V_{SCPINMAX}$	-0.3 to +6.0 <sup>(Note 3)</sup>	V
TO1, TO2 Pin Input Voltage	$V_{TOMAX}$	-0.3 to $V_{CC2} + 0.3$ <sup>(Note 3)</sup>	V
TO1, TO2 Pin Output Current	$I_{TOMAX}$	8	mA
OUT1L Pin Output Current (Peak 5 $\mu$ s)	$I_{OUT1LPEAK}$	self limited <sup>(Note 4)</sup>	A
OUT2 Pin Output Current (Peak 5 $\mu$ s)	$I_{OUT2PEAK}$	self limited <sup>(Note 4)</sup>	A
PROOUT1 Pin Output Current (Peak 10 $\mu$ s)	$I_{PROOUT1PEAK}$	self limited <sup>(Note 4)</sup>	A
PROOUT2 Pin Output Current (Peak 5 $\mu$ s)	$I_{PROOUT2PEAK}$	self limited <sup>(Note 4)</sup>	A
Storage Temperature Range	Tstg	-55 to +150	°C
Maximum Junction Temperature	Tjmax	+150	°C

**Caution 1:** Operating the IC over the absolute maximum ratings may damage the IC. The damage can either be a short circuit between pins or an open circuit between pins and the internal circuitry. Therefore, it is important to consider circuit protection measures, such as adding a fuse, in case the IC is operated over the absolute maximum ratings.

**Caution 2:** Should by any chance the maximum junction temperature rating be exceeded the rise in temperature of the chip may result in deterioration of the properties of the chip. In case of exceeding this absolute maximum rating, design a PCB with thermal resistance taken into consideration by increasing board size and copper area so as not to exceed the maximum junction temperature rating.

(Note 2) Relative to GND1

(Note 3) Relative to GND2

(Note 4) Should not exceed Tjmax = 150 °C

**Thermal Resistance** (Note 5)

Parameter	Symbol	Thermal Resistance (Typ)		Unit
		1s <sup>(Note 7)</sup>	2s2p <sup>(Note 8)</sup>	
SSOP-B28W				
Junction to Ambient	$\theta_{JA}$	112.9	64.4	°C/W
Junction to Top Characterization Parameter <sup>(Note 6)</sup>	$\Psi_{JT}$	34	23	°C/W

(Note 5) Based on JESD51-2A (Still-Air).

(Note 6) The thermal characterization parameter to report the difference between junction temperature and the temperature at the top center of the outside surface of the component package.

(Note 7) Using a PCB board based on JESD51-3.

(Note 8) Using a PCB board based on JESD51-7.

Layer Number of Measurement Board	Material	Board Size
Single	FR-4	114.3 mm x 76.2 mm x 1.57 mmt

Top	
Copper Pattern	Thickness
Footprints and Traces	70 $\mu$ m

Layer Number of Measurement Board	Material	Board Size
4 Layers	FR-4	114.3 mm x 76.2 mm x 1.6 mmt

Top		2 Internal Layers		Bottom	
Copper Pattern	Thickness	Copper Pattern	Thickness	Copper Pattern	Thickness
Footprints and Traces	70 $\mu$ m	74.2 mm x 74.2 mm	35 $\mu$ m	74.2 mm x 74.2 mm	70 $\mu$ m

**Recommended Operating Conditions**

Parameter	Symbol	Min	Max	Unit
Main Power Supply Voltage	$V_{BATT}$ <sup>(Note 9)</sup>	4.5	24.0	V
Output-side Supply Voltage	$V_{CC2}$ <sup>(Note 10)</sup>	$V_{UVLO2L}$	24	V
TO1, TO2 pin Input Voltage	$V_{TO}$ <sup>(Note 10)</sup>	1.35	3.84	V
Operating Temperature	$T_{opr}$	-40	+125	°C

(Note 9) Relative to GND1

(Note 10) Relative to GND2

**Insulation Related Characteristics**

Parameter	Symbol	Characteristic	Unit
Insulation Resistance ( $V_{IO} = 500$ V)	$R_S$	$> 10^9$	$\Omega$
Insulation Withstand Voltage (1 min)	$V_{ISO}$	2500	Vrms
Insulation Test Voltage (1 s)	$V_{ISO}$	3000	Vrms

**Electrical Characteristics**(Unless otherwise specified Ta = -40 °C to +125 °C, V<sub>BATT</sub> = 5 V to 24 V, V<sub>CC2</sub> = V<sub>UVLO2L</sub> to 24 V)

Parameter	Symbol	Min	Typ	Max	Unit	Conditions
<b>General</b>						
Main Power Supply Circuit Current 1	I <sub>BATT1</sub>	0.5	1.2	2.0	mA	FET_G switching operation INA, DIS not switching
Main Power Supply Circuit Current 2	I <sub>BATT2</sub>	0.4	1.1	1.9	mA	FET_G Not switching INA, DIS not switching
Main Power Supply Circuit Current 3	I <sub>BATT3</sub>	0.6	1.3	2.1	mA	FET_G switching operation INA = 10 kHz, Duty = 50 % DIS = L
Main Power Supply Circuit Current 4	I <sub>BATT4</sub>	0.6	1.4	2.3	mA	FET_G switching operation INA = 20 kHz, Duty = 50 % DIS = L
Output-side Circuit Current	I <sub>CC2</sub>	2.8	5.0	7.6	mA	R <sub>TC</sub> = 10 kΩ
VREG Output Voltage 1	V <sub>REG1</sub>	4.5	5.0	5.5	V	5 V ≤ V <sub>BATT</sub> ≤ 24 V
VREG Output Voltage 2	V <sub>REG2</sub>	4.0	4.5	-	V	V <sub>BATT</sub> = 4.5 V
<b>Switching Controller</b>						
FET_G Output Voltage H1	V <sub>FETGH1</sub>	4.5	5.0	5.5	V	5 V ≤ V <sub>BATT</sub> ≤ 24 V I <sub>FET_G</sub> = 0 A (open)
FET_G Output Voltage H2	V <sub>FETGH2</sub>	4.0	4.5	-	V	V <sub>BATT</sub> = 4.5 V I <sub>FET_G</sub> = 0 A (open)
FET_G Output Voltage L	V <sub>FETGL</sub>	0	-	0.3	V	I <sub>FET_G</sub> = 0 A (open)
FET_G On Resistance (Source-side)	R <sub>ONGH</sub>	3	6	12	Ω	I <sub>FET_G</sub> = -10 mA
FET_G On Resistance (Sink-side)	R <sub>ONGL</sub>	0.3	0.6	1.3	Ω	I <sub>FET_G</sub> = +10 mA
Oscillation Frequency	f <sub>OSC_SW</sub>	170	200	230	kHz	
Soft-start Time	t <sub>SS</sub>	-	-	50	ms	
FB Threshold Voltage	V <sub>FB</sub>	1.47	1.50	1.53	V	
FB Input Current	I <sub>FB</sub>	-0.8	0	+0.8	μA	
COMP Output Sink Current	I <sub>COMPSINK</sub>	-160	-80	-40	μA	
COMP Output Source Current	I <sub>COMPSOURCE</sub>	40	80	160	μA	
V_BATT UVLO Off Voltage	V <sub>UVLOBATTH</sub>	4.05	4.25	4.45	V	
V_BATT UVLO On Voltage	V <sub>UVLOBATTL</sub>	3.95	4.15	4.35	V	
Maximum On Duty	D <sub>ONMAX</sub>	75	85	95	%	
<b>Logic Block</b>						
Logic High Level Input Voltage	V <sub>INH</sub>	0.7 x V <sub>REG</sub>	-	5.5	V	INA, DIS, TO_SEL
Logic Low Level Input Voltage	V <sub>INL</sub>	0	-	0.3 x V <sub>REG</sub>	V	INA, DIS, TO_SEL
Logic Pull Down Resistance	R <sub>IND</sub>	25	50	100	kΩ	INA, TO_SEL
Logic Pull Up Resistance	R <sub>INU</sub>	25	50	100	kΩ	DIS
Logic Input Filtering Time	t <sub>INFIL</sub>	80	130	180	ns	INA, DIS

Electrical Characteristics - continued

Parameter	Symbol	Min	Typ	Max	Unit	Conditions
<b>Output</b>						
OUT1HG H Level Output Voltage	$V_{OUT1HGH}$	$V_{CC2} - 0.8$	-	-	V	$I_{OUT1HG} = -40 \text{ mA}$
OUT1HG L Level Output Voltage	$V_{OUT1HGL}$	-	-	0.6	V	$I_{OUT1HG} = +40 \text{ mA}$
OUTREF Reference Voltage	$V_{OUTREF}$	1.96	2.00	2.04	V	Relative to $V_{CC2}$ (Absolute Value)
OUT1L On Resistance	$R_{OUT1L}$	-	0.15	0.30	$\Omega$	$I_{OUT1L} = 40 \text{ mA}$
OUT1L Maximum Current	$I_{OUTMAX1}$	10	-	-	A	$V_{CC2} = 15 \text{ V}$ , Guaranteed by design
OUT1 Turn On Time	$t_{PON}$	210	330	450	ns	INA, DIS
OUT1 Turn Off Time	$t_{POFF}$	210	330	450	ns	INA, DIS
OUT1HG-OUT1L Dead Time	$t_{DEAD}$	100	160	220	ns	
OUT1HG L to H Transition Time	$t_{OUT1HGLH}$	-	25	50	ns	Between OUT1HG and $V_{CC2} = 1000 \text{ pF}$ Guaranteed by design
PROOUT1 On Resistance	$R_{ONPRO1}$	0.4	0.9	2.0	$\Omega$	$I_{PROOUT1} = 40 \text{ mA}$
PROOUT2 On Resistance	$R_{ONPRO2}$	0.2	0.4	0.9	$\Omega$	$I_{PROOUT2} = 40 \text{ mA}$
OUT2 On Resistance	$R_{ON2}$	0.25	0.45	1.00	$\Omega$	$I_{OUT2} = 40 \text{ mA}$
OUT2 On Threshold Voltage	$V_{OUT2ON}$	1.8	2.0	2.2	V	
OUT2 On Delay Time	$t_{OUT2ON}$	-	70	115	ns	
Common Mode Transient Immunity	CM	100	-	-	kV/ $\mu\text{s}$	Guaranteed by design

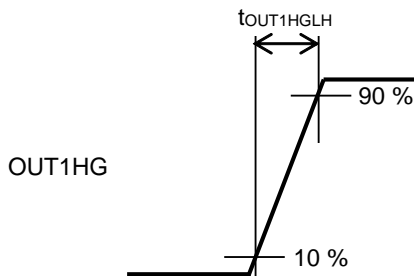
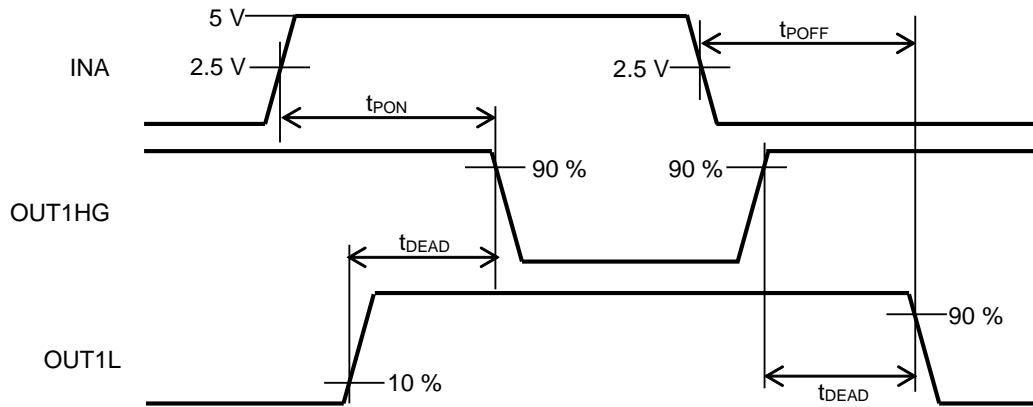

## Electrical Characteristics - continued

Parameter	Symbol	Min	Typ	Max	Unit	Conditions
<b>Temperature Monitor</b>						
TC Voltage	$V_{TC}$	0.980	1.000	1.020	V	
TO1, TO2 Output Current	$I_{TO}$	0.975	1.000	1.025	mA	$R_{TC} = 10\text{ k}\Omega$
TO1, TO2 Output Current Offset	$I_{TOOFFSET}$	-22	0	+22	$\mu\text{A}$	$R_{TC} = 10\text{ k}\Omega$
SENSOR Output Frequency	$f_{OSC\_TO}$	8	10	14	kHz	
SENSOR Output Duty1	$D_{SENSOR1}$	87.5	90.0	92.5	%	$V_{TO1} = V_{TO2} = 1.35\text{ V}$
SENSOR Output Duty2	$D_{SENSOR2}$	47.0	50.0	53.0	%	$V_{TO1} = V_{TO2} = 2.59\text{ V}$
SENSOR Output Duty3	$D_{SENSOR3}$	5.6	10.0	14.4	%	$V_{TO1} = V_{TO2} = 3.84\text{ V}$
TO1,TO2 Input Voltage Offset	$V_{TOOFFSET}$	-13	0	+13	mV	Guaranteed by design
TO_SEL Switching Time	$t_{TOSEL}$	-	-	1.0	$\mu\text{s}$	
SENSOR On Resistance (Source-side)	$R_{SENSORH}$	-	60	160	$\Omega$	$I_{SENSOR} = -5\text{ mA}$
SENSOR On Resistance (Sink-side)	$R_{SENSORL}$	-	60	160	$\Omega$	$I_{SENSOR} = +5\text{ mA}$
<b>Protection Functions</b>						
VREG UVLO Off Voltage	$V_{UVLO1H}$	4.05	4.25	4.45	V	
VREG UVLO On Voltage	$V_{UVLO1L}$	3.95	4.15	4.35	V	
VREG UVLO Filtering Time	$t_{UVLO1FIL}$	2	10	30	$\mu\text{s}$	
VREG UVLO Delay Time (OUT1HG)	$t_{DUVLO1OUT1HG}$	2	10	30	$\mu\text{s}$	
VREG UVLO Delay Time (FLT)	$t_{DUVLO1FLT}$	2	10	30	$\mu\text{s}$	
Output-side UVLO Off Threshold Voltage	$V_{UVLO2H}$	10.7	11.7	12.7	V	
Output-side UVLO On Threshold Voltage	$V_{UVLO2L}$	9.7	10.7	11.7	V	
Output-side UVLO Filtering Time	$t_{UVLO2FIL}$	2	10	30	$\mu\text{s}$	
Output-side UVLO Delay Time (OUT1HG)	$t_{DUVLO2OUT1HG}$	2	10	30	$\mu\text{s}$	
Output-side UVLO Delay Time (FLT)	$t_{DUVLO2FLT}$	3	-	65	$\mu\text{s}$	
Short Current Detection Voltage	$V_{SCDET}$	0.67	0.70	0.73	V	
Short Current Detection Delay Time (OUT1HG)	$t_{DSCPOUT1HG}$	0.02	0.07	0.11	$\mu\text{s}$	OUT1HG = 1 k $\Omega$ Pull up
Short Current Detection Delay Time (PROOUT1)	$t_{DSCPPRO1}$	0.02	0.05	0.08	$\mu\text{s}$	PROOUT1 = 30 k $\Omega$ Pull up
Short Current Detection Delay Time (PROOUT2)	$t_{DSCPPRO2}$	0.02	0.05	0.08	$\mu\text{s}$	PROOUT2 = 30 k $\Omega$ Pull up
Short Current Detection Delay Time (FLT)	$t_{DSCPFLT}$	1	-	35	$\mu\text{s}$	
PROOUT2 On Time	$t_{PRO2ON}$	100	160	220	ns	
Soft Turn Off Release Time	$t_{SCPOFF}$	30	-	110	$\mu\text{s}$	OUT1L = 30 k $\Omega$ Pull up
FLT Output On Resistance	$R_{FLTL}$	-	30	80	$\Omega$	$I_{FLT} = 5\text{ mA}$
Fault Output Holding Time	$t_{FLTRLS}$	30	40	50	ms	
Gate State H Detection Threshold Voltage	$V_{OSFBH}$	4.5	5.0	5.5	V	
Gate State L Detection Threshold Voltage	$V_{OSFBL}$	4.0	4.5	5.0	V	
OSFB Output Filtering Time	$t_{OSFBFIL}$	5.0	7.4	9.8	$\mu\text{s}$	
OSFB Output On Resistance	$R_{OSFBL}$	-	30	80	$\Omega$	$I_{OSFB} = 5\text{ mA}$
OSFB Output Holding Time	$t_{OSFBRLS}$	30	40	50	ms	



Typical Performance Curves

(Reference data)

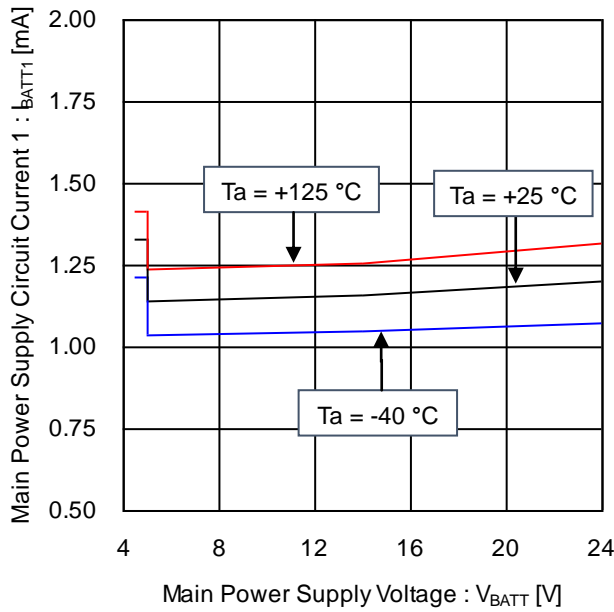

Figure 1. Main Power Supply Circuit Current 1 vs Main Power Supply Voltage (FET\_G switching operation, INA not switching)

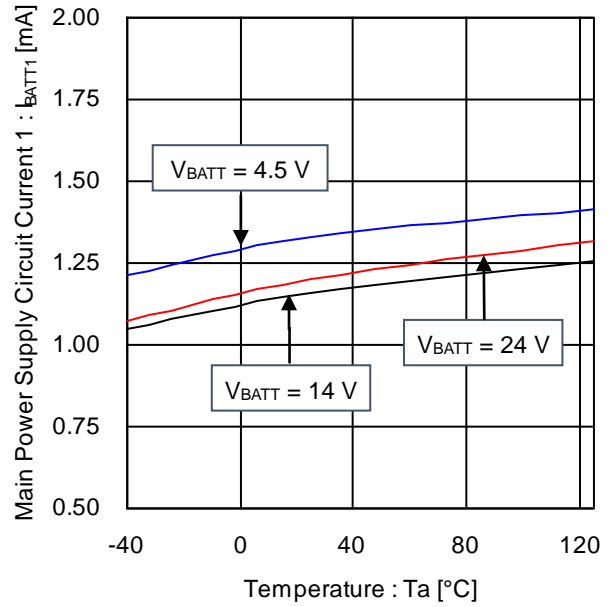

Figure 2. Main Power Supply Circuit Current 1 vs Temperature (FET\_G switching operation, INA not switching)

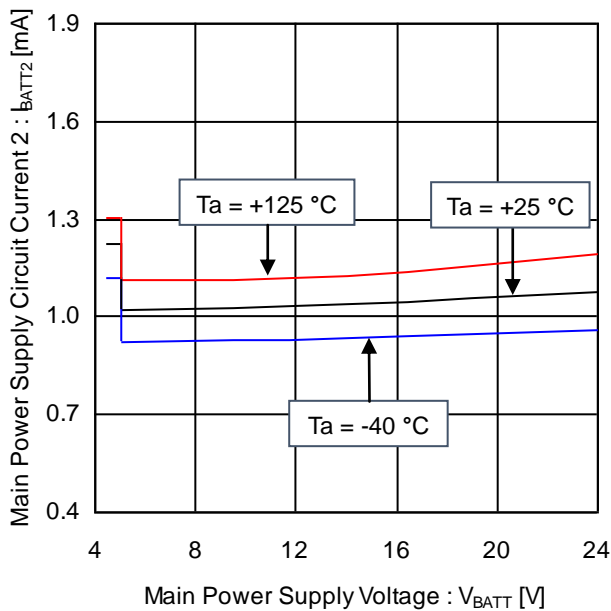

Figure 3. Main Power Supply Circuit Current 2 vs Main Power Supply Voltage (FET\_G not switching, INA not switching)

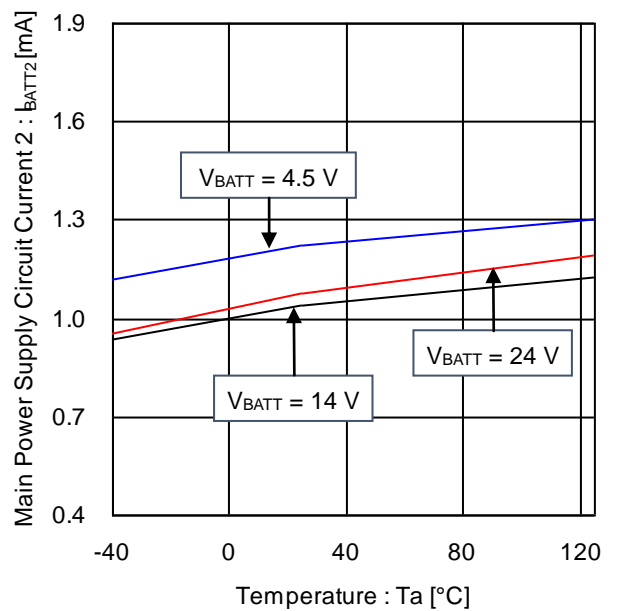

Figure 4. Main Power Supply Circuit Current 2 vs Temperature (FET\_G not switching, INA not switching)

Typical Performance Curves - continued

(Reference data)

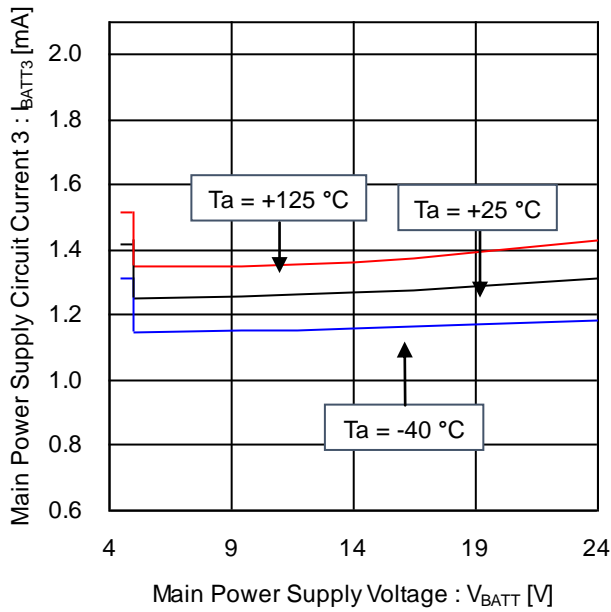

Figure 5. Main Power Supply Circuit Current 3 vs Main Power Supply Voltage  
(FET\_G switching operation, INA = 10 kHz, Duty = 50 %)

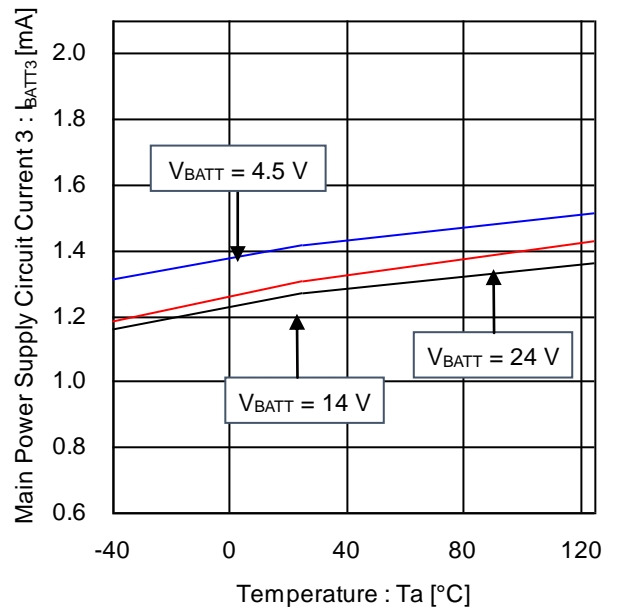

Figure 6. Main Power Supply Circuit Current 3 vs Temperature  
(FET\_G switching operation, INA = 10 kHz, Duty = 50 %)

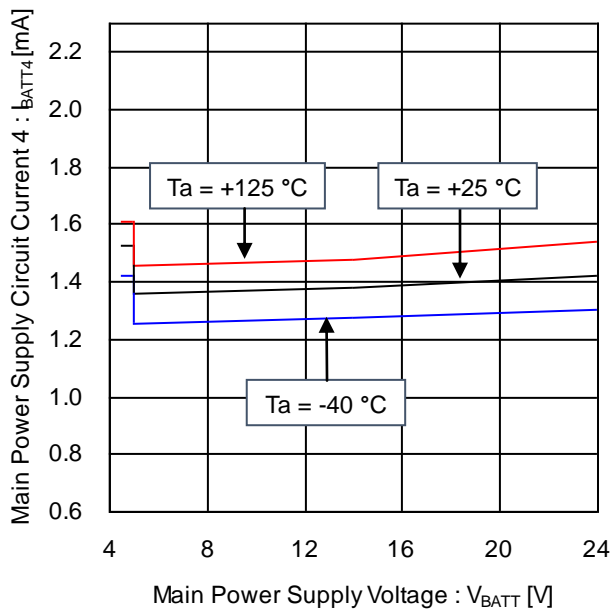

Figure 7. Main Power Supply Circuit Current 4 vs Main Power Supply Voltage  
(FET\_G switching operation, INA = 20 kHz, Duty = 50 %)

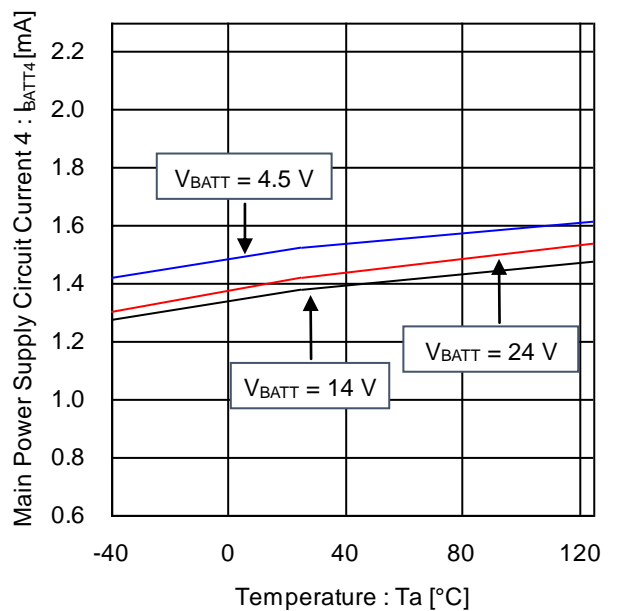

Figure 8. Main Power Supply Circuit Current 4 vs Temperature  
(FET\_G switching operation, INA = 20 kHz, Duty = 50 %)

Typical Performance Curves - continued  
(Reference data)

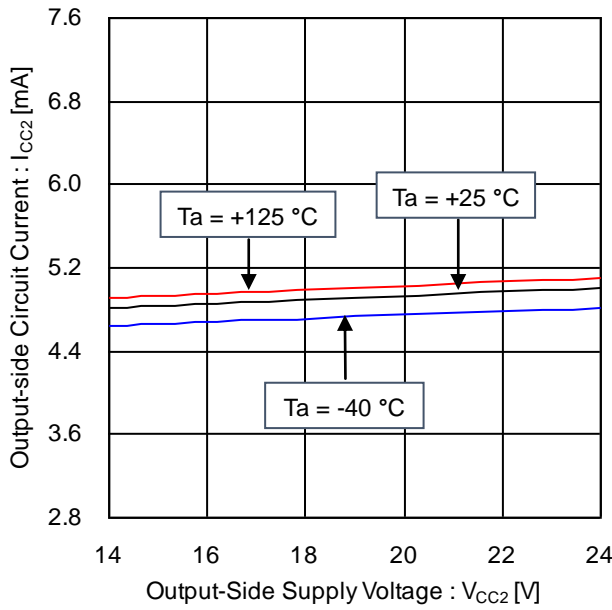

Figure 9. Output-side Circuit Current vs Output-Side Supply Voltage  
( $R_{TC} = 10k\Omega$ )

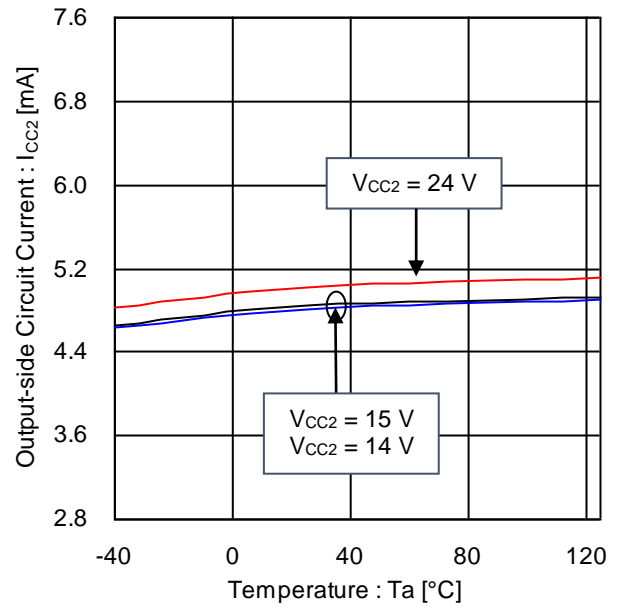

Figure 10. Output-side Circuit Current vs Temperature  
( $R_{TC} = 10k\Omega$ )

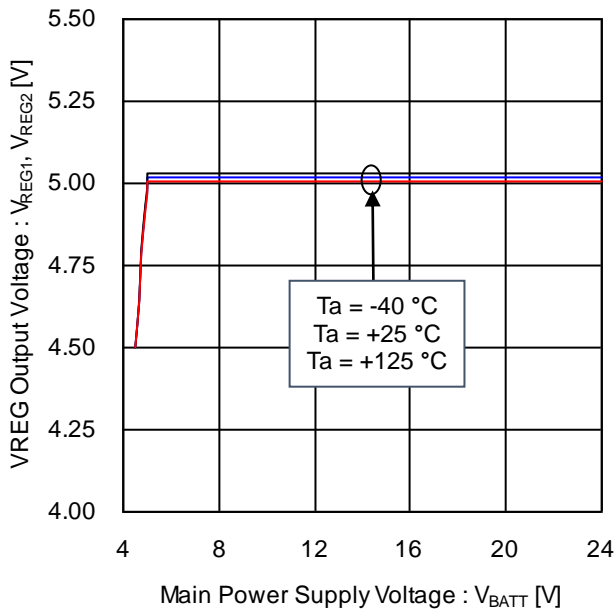

Figure 11. VREG Output Voltage vs Main Power Supply Voltage

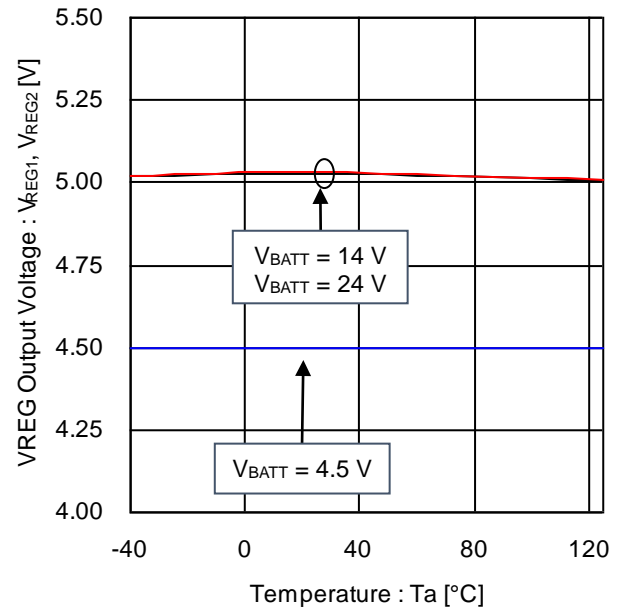

Figure 12. VREG Output Voltage vs Temperature

Typical Performance Curves - continued  
(Reference data)

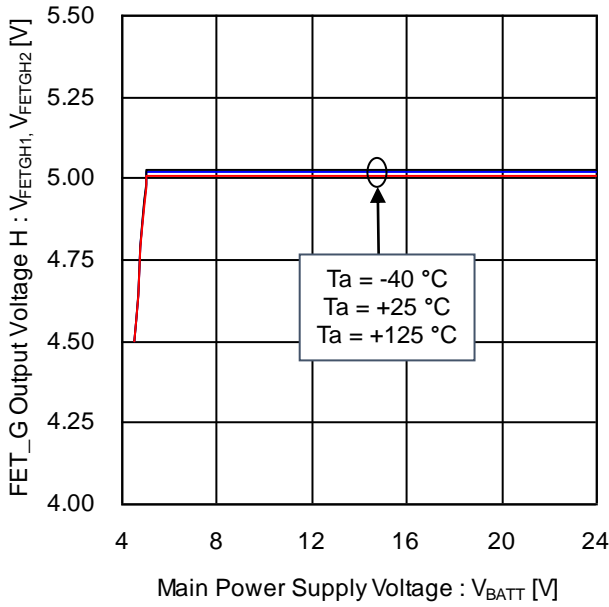

Figure 13. FET\_G Output Voltage H vs Main Power Supply Voltage

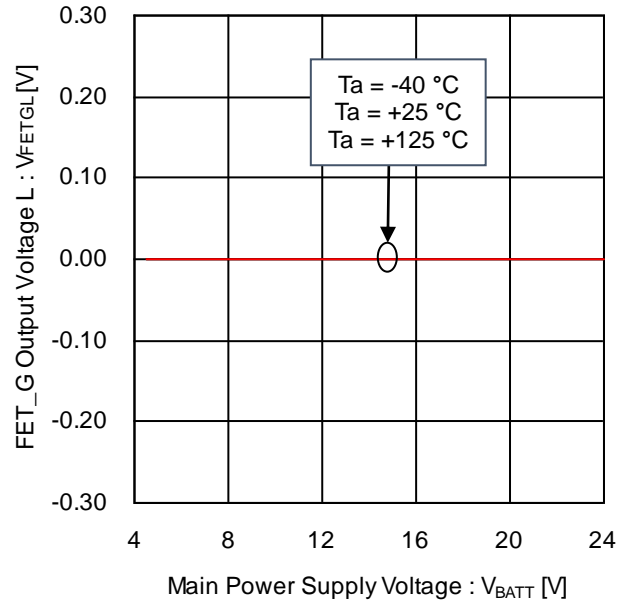

Figure 14. FET\_G Output Voltage L vs Main Power Supply Voltage

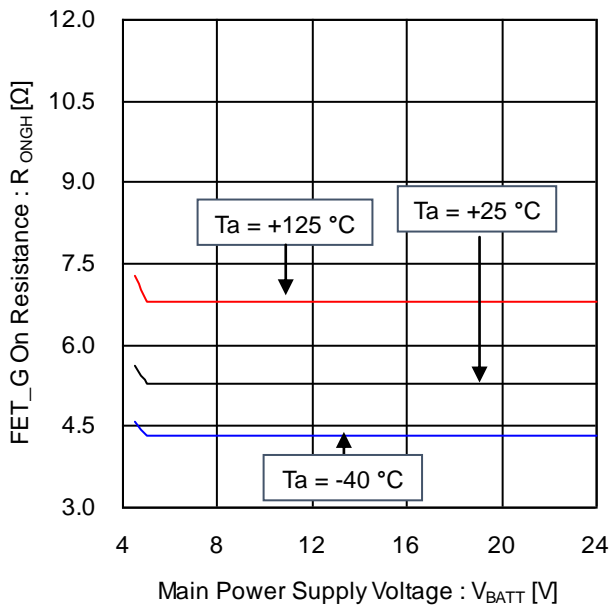

Figure 15. FET\_G On Resistance (Source-side) vs Main Power Supply Voltage

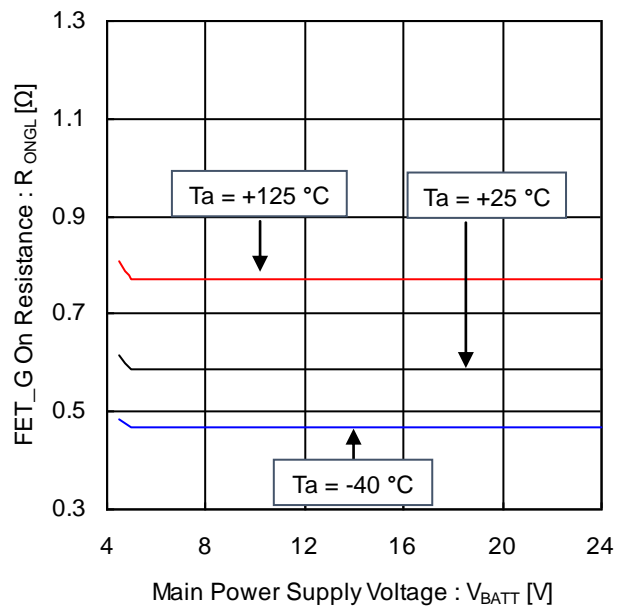

Figure 16. FET\_G On Resistance (Sink-side) vs Main Power Supply Voltage

Typical Performance Curves - continued  
(Reference data)

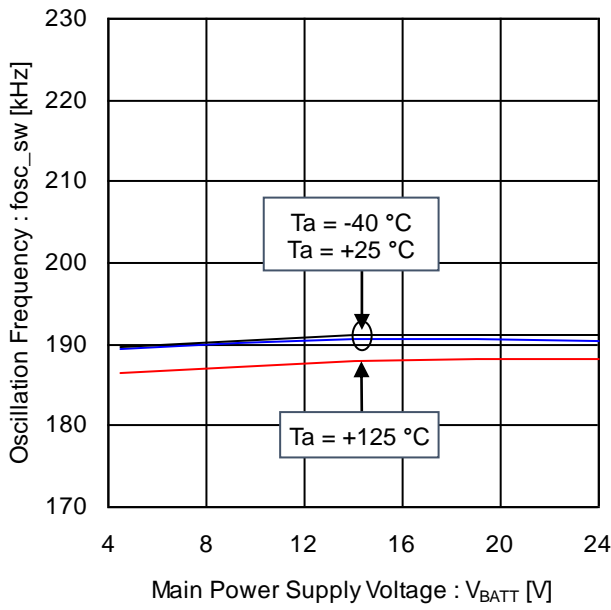

Figure 17. Oscillation Frequency vs Main Power Supply Voltage

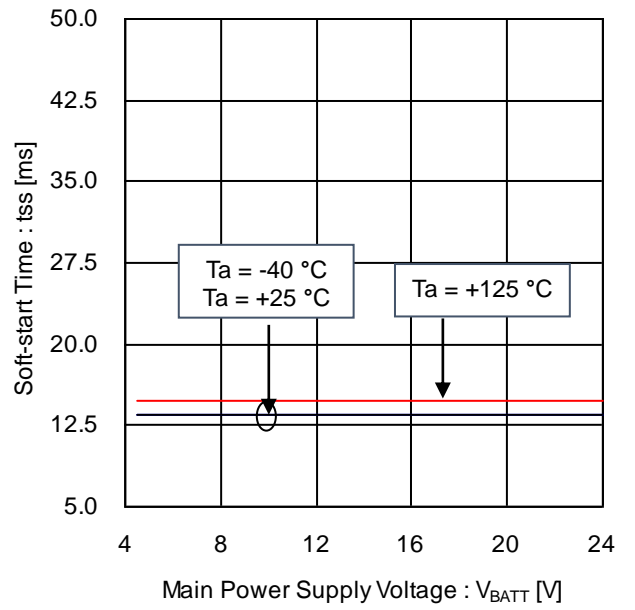

Figure 18. Soft-start Time vs Main Power Supply Voltage

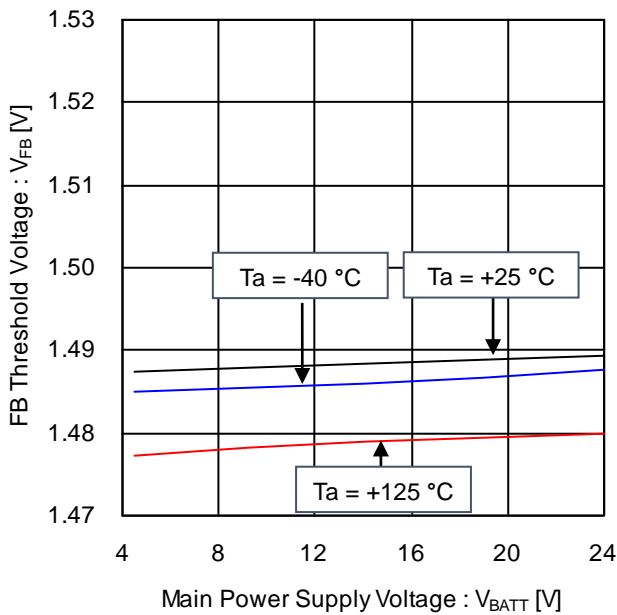

Figure 19. FB Threshold Voltage vs Main Power Supply Voltage

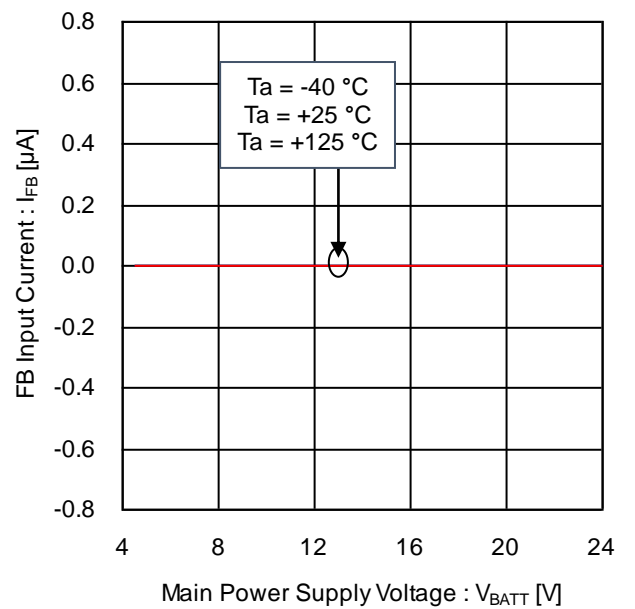

Figure 20. FB Input Current vs Main Power Supply Voltage

Typical Performance Curves - continued  
(Reference data)

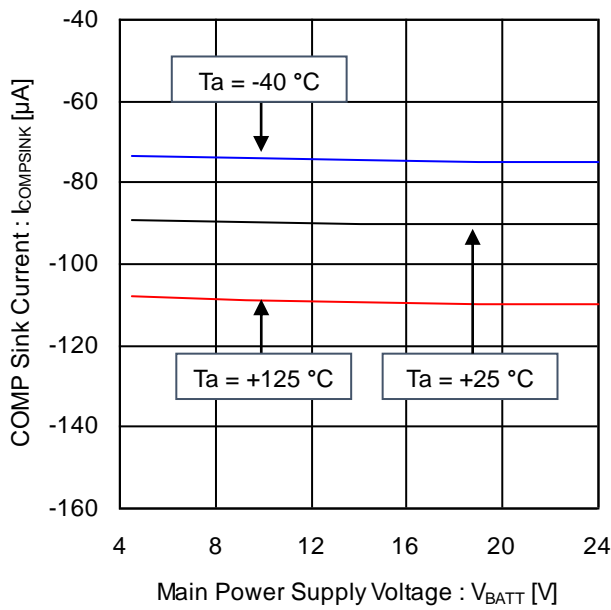

Figure 21. COMP Sink Current vs Main Power Supply Voltage

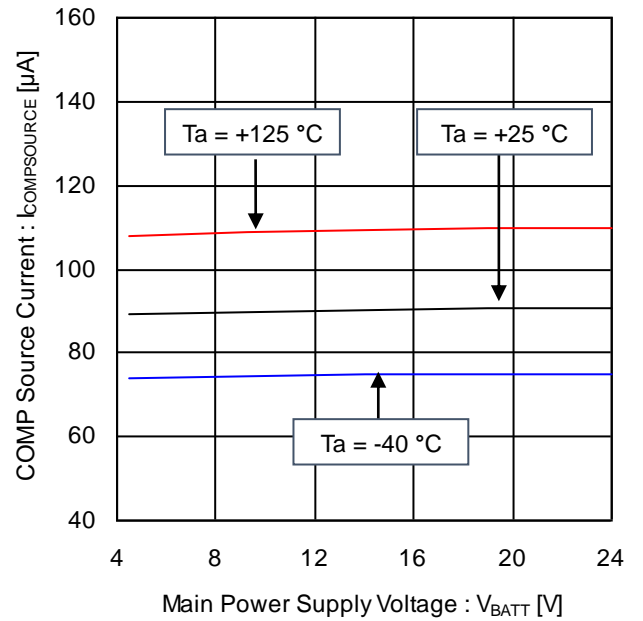

Figure 22. COMP Source Current vs Main Power Supply Voltage

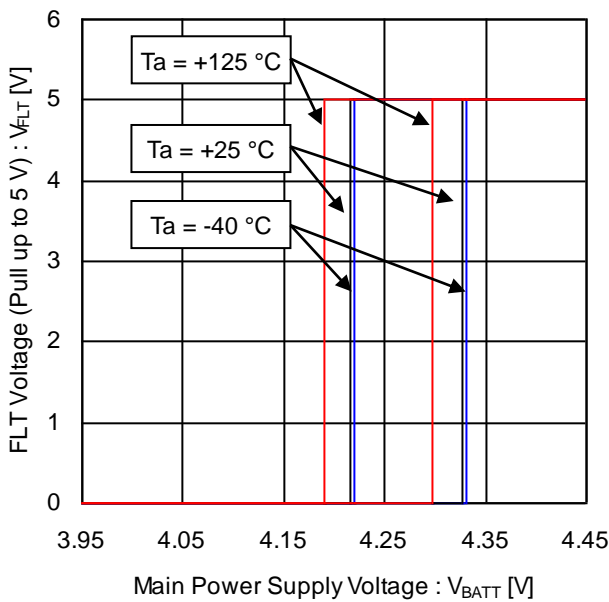

Figure 23. FLT Voltage vs Main Power Supply Voltage (V\_BATT UVLO On / Off Voltage)

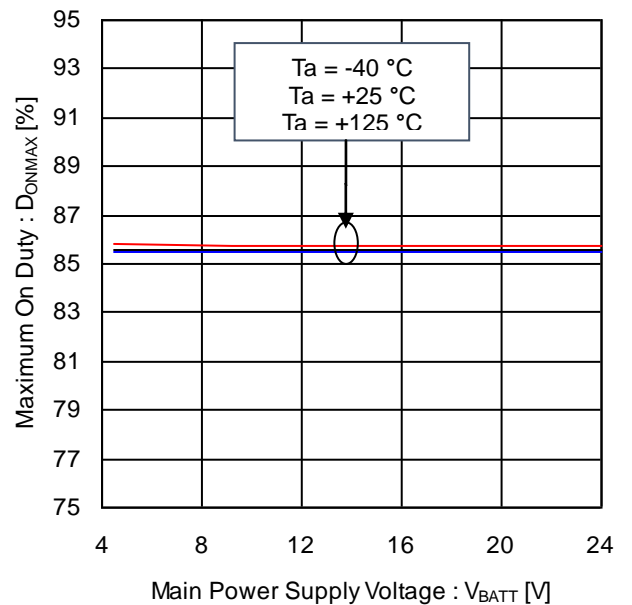

Figure 24. Maximum On Duty vs Main Power Supply Voltage

Typical Performance Curves - continued  
(Reference data)

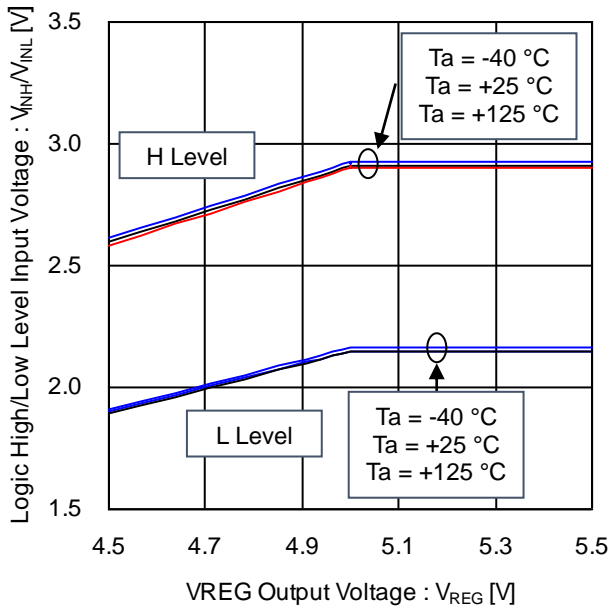

Figure 25. Logic High/Low Level Input Voltage vs VREG Output Voltage

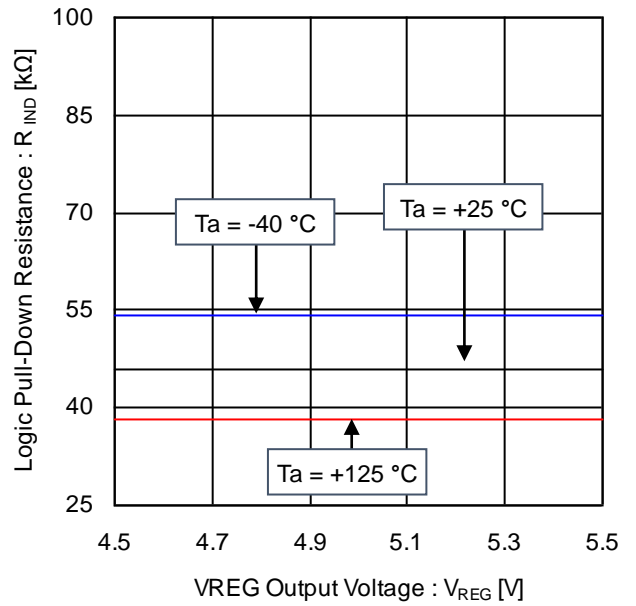

Figure 26. Logic Pull Down Resistance vs VREG Output Voltage

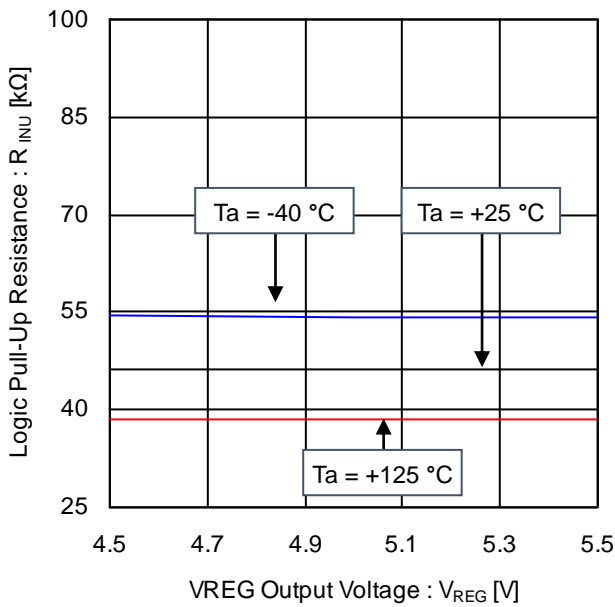

Figure 27. Logic Pull Up Resistance vs VREG Output Voltage

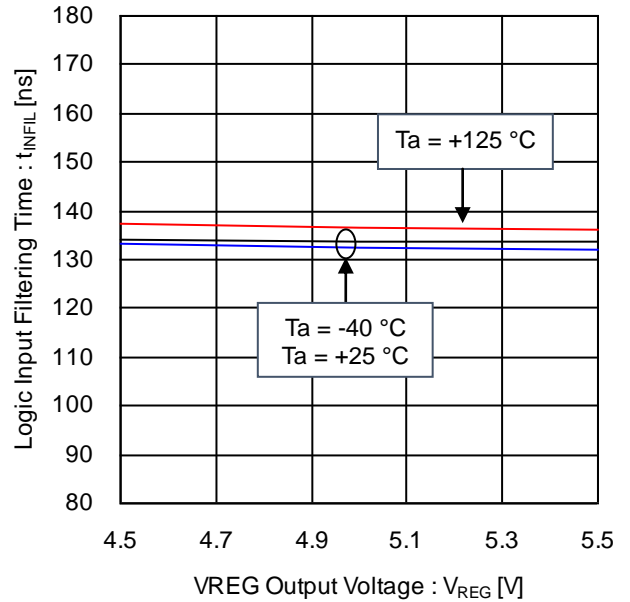

Figure 28. Logic Input Filtering Time vs VREG Output Voltage

Typical Performance Curves - continued  
(Reference data)

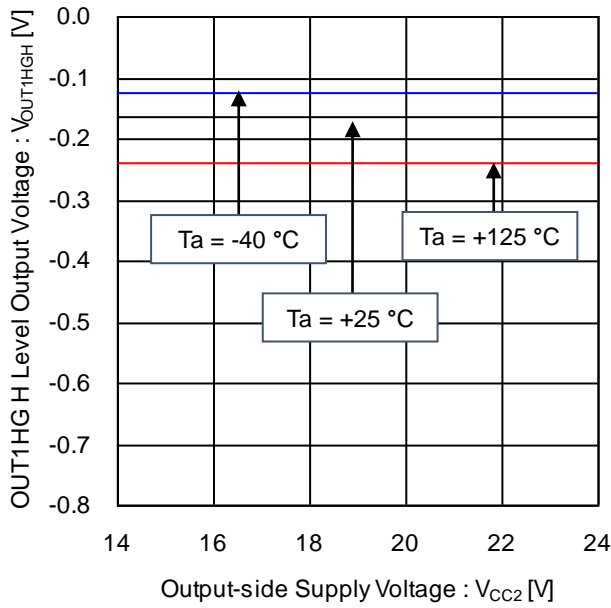

Figure 29. OUT1HG H Level Output Voltage vs Output-side Supply Voltage  
( $I_{OUT1HG} = -40 \text{ mA}$ )

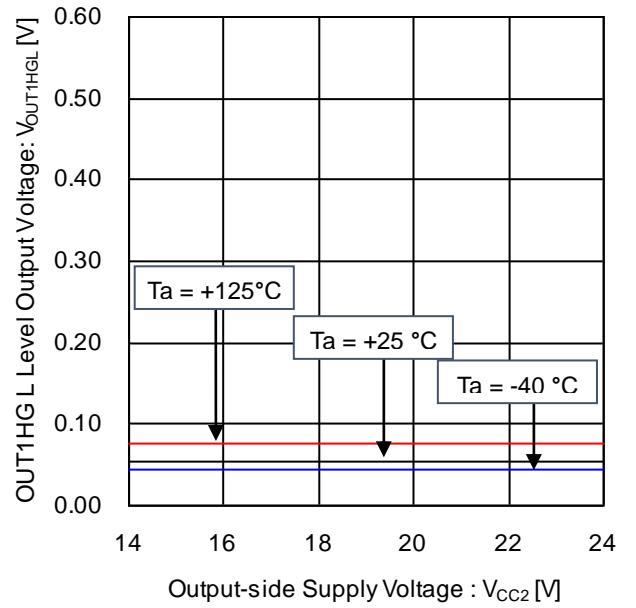

Figure 30. OUT1HG L Level Output Voltage vs Output-side Supply Voltage  
( $I_{OUT1HG} = +40 \text{ mA}$ )

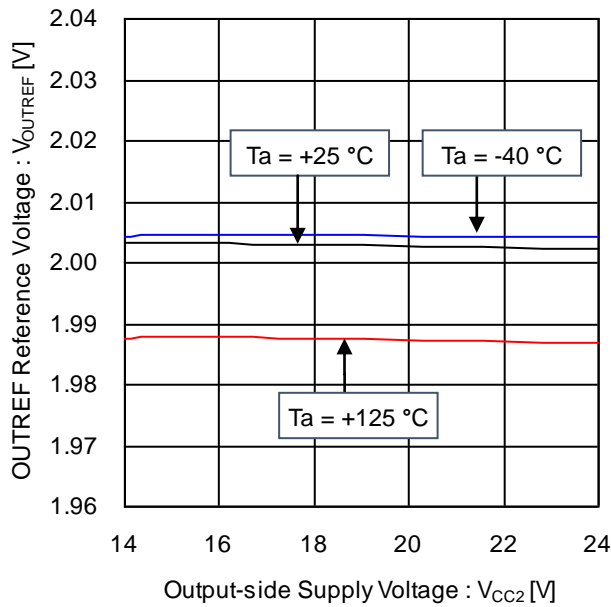

Figure 31. OUTREF Reference Voltage vs Output-side Supply Voltage  
(Relative to VCC2)

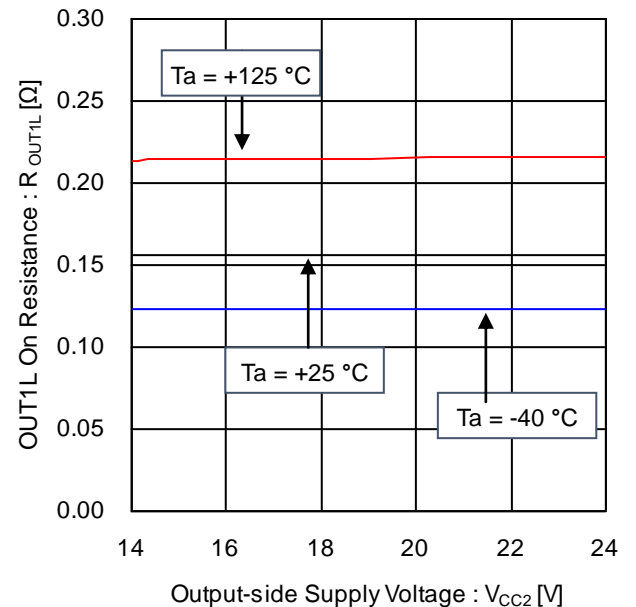

Figure 32. OUT1L On Resistance vs Output-side Supply Voltage  
( $I_{OUT1L} = 40 \text{ mA}$ )



Typical Performance Curves - continued  
(Reference data)

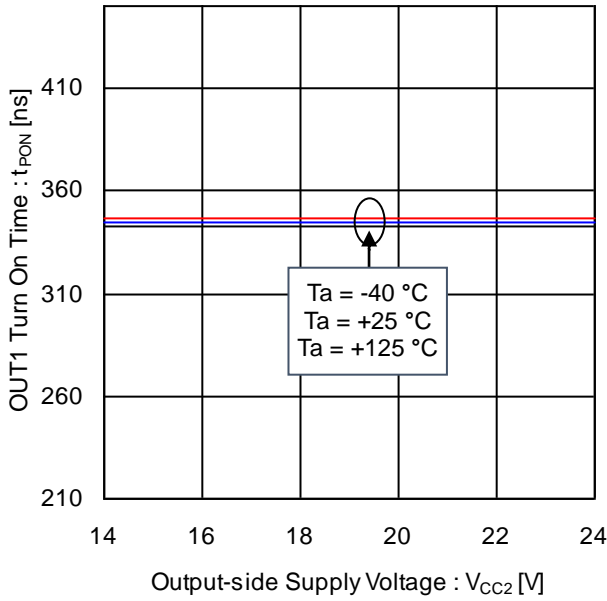

Figure 33. OUT1 Turn On Time vs Output-side Supply Voltage

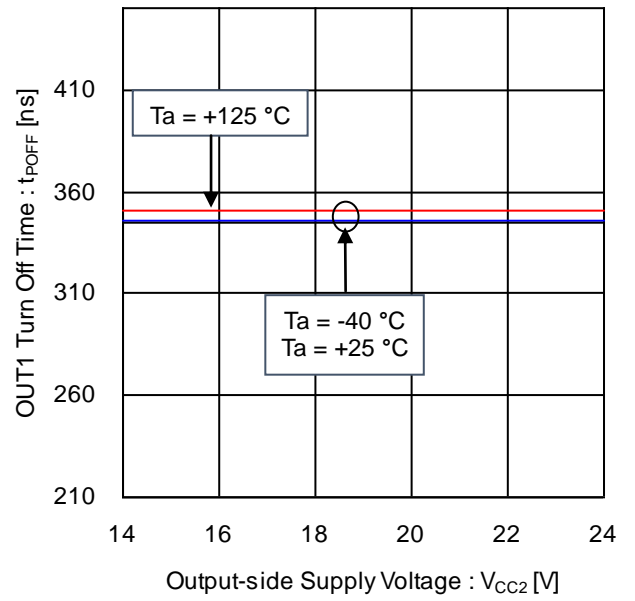

Figure 34. OUT1 Turn Off Time vs Output-side Supply Voltage

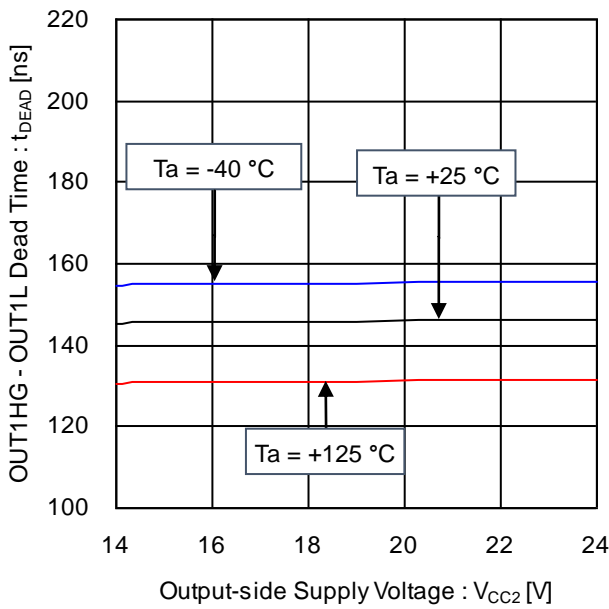

Figure 35. OUT1HG - OUT1L Dead Time vs Output-side Supply Voltage

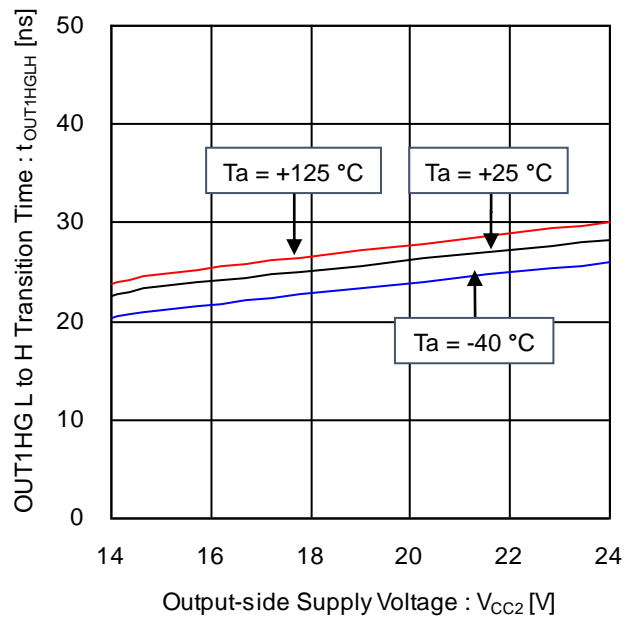

Figure 36. OUT1HG L to H Transition Time vs Output-side Supply Voltage (Between OUT1HG and  $V_{CC2} = 1000\text{ pF}$ )

Typical Performance Curves - continued  
(Reference data)

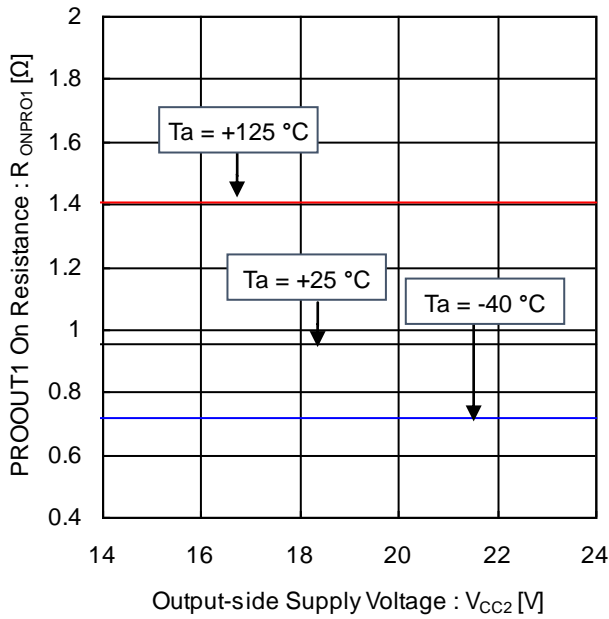

Figure 37. PROOUT1 On Resistance vs Output-side Supply Voltage  
( $I_{PROOUT1} = 40 \text{ mA}$ )

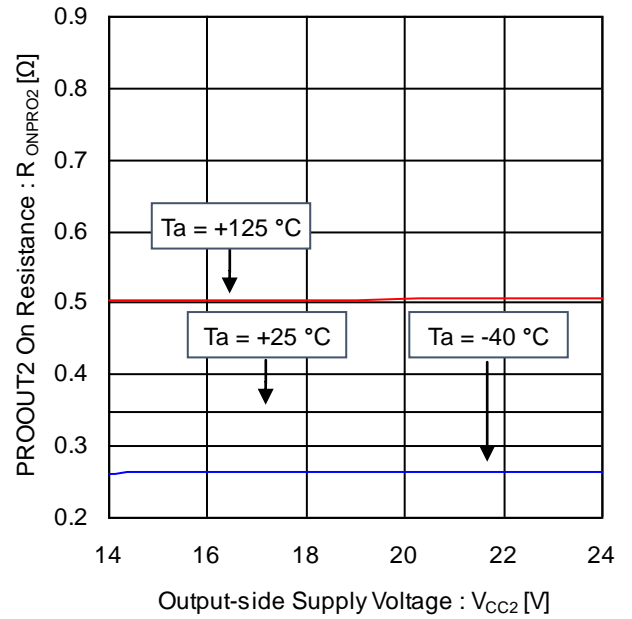

Figure 38. PROOUT2 On Resistance vs Output-side Supply Voltage  
( $I_{PROOUT2} = 40 \text{ mA}$ )

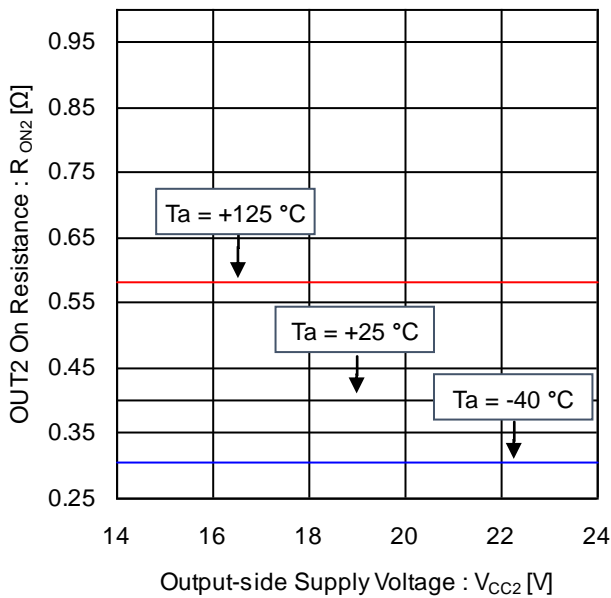

Figure 39. OUT2 On Resistance vs Output Side Supply Voltage  
( $I_{OUT2} = 40 \text{ mA}$ )

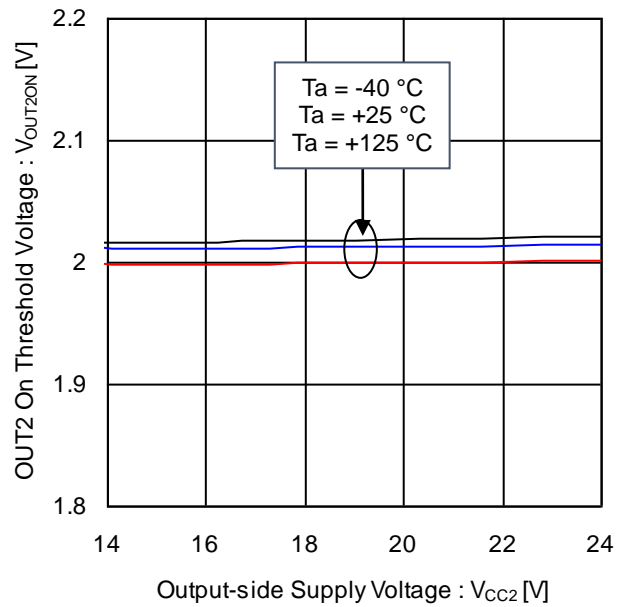

Figure 40. OUT2 On Threshold Voltage vs Output Side Supply Voltage

Typical Performance Curves - continued  
(Reference data)

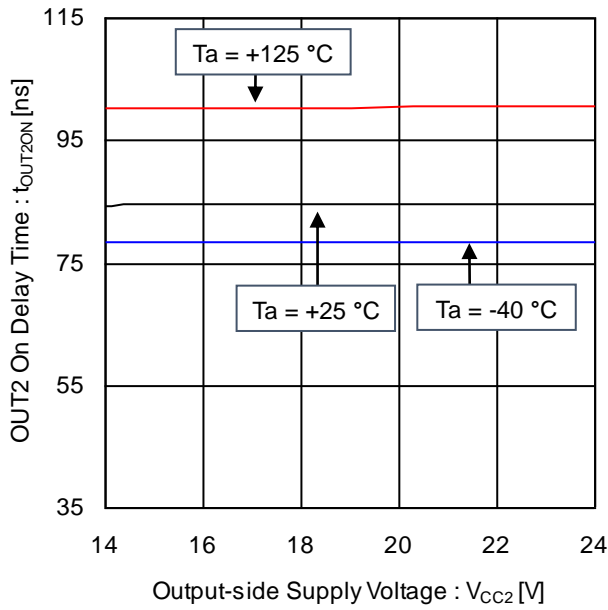

Figure 41. OUT2 On Delay Time vs Output-side Supply Voltage

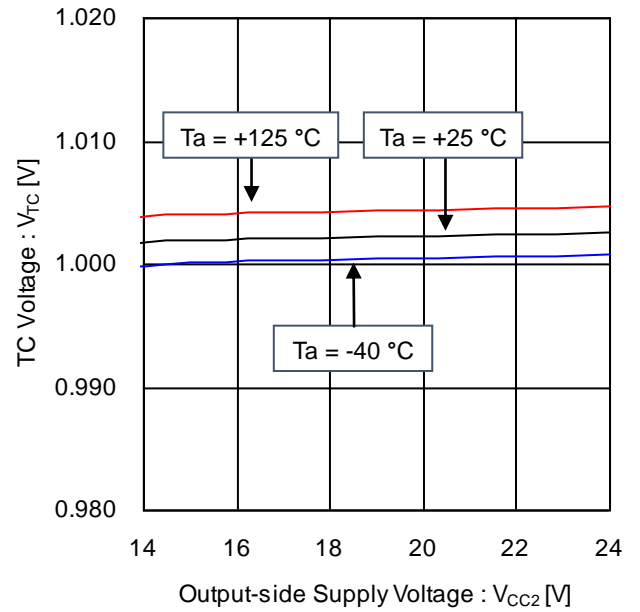

Figure 42. TC Voltage vs Output-side Supply Voltage

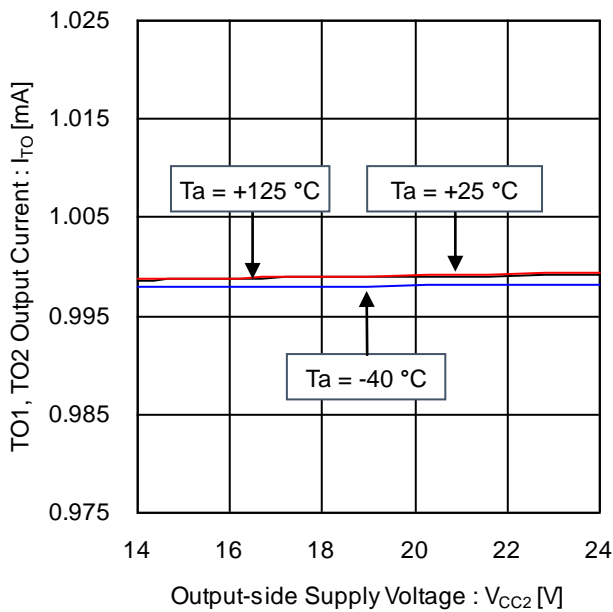

Figure 43. TO1, TO2 Output Current vs Output-side Supply Voltage  
( $R_{TC} = 10 \text{ k}\Omega$ )

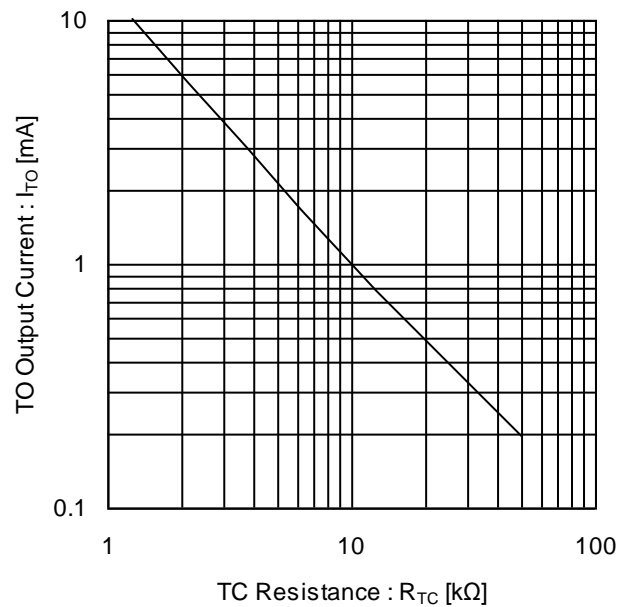

Figure 44. TO Output Current vs TC Resistance

Typical Performance Curves - continued  
(Reference data)

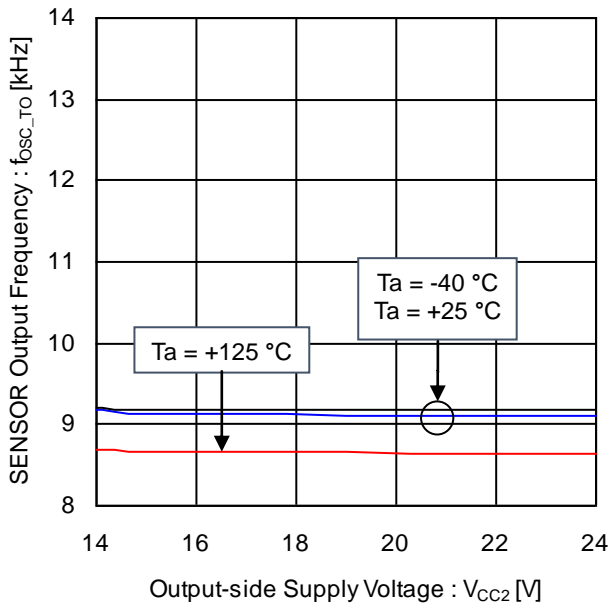

Figure 45. SENSOR Output Frequency vs Output-side Supply Voltage

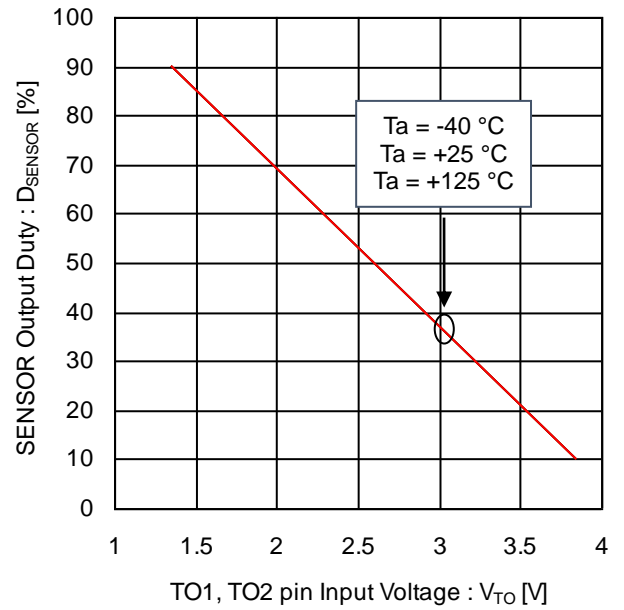

Figure 46. SENSOR Output Duty vs TO1, TO2 pin Input Voltage

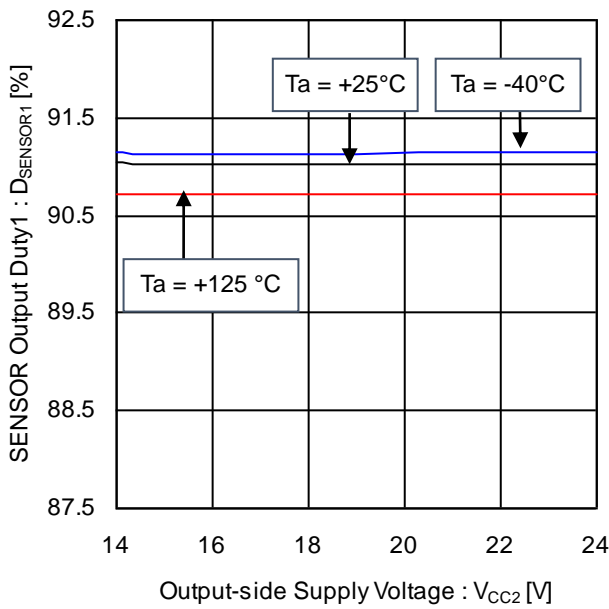

Figure 47. SENSOR Output Duty1 vs Output-side Supply Voltage  
( $V_{TO1} = V_{TO2} = 1.35 \text{ V}$ )

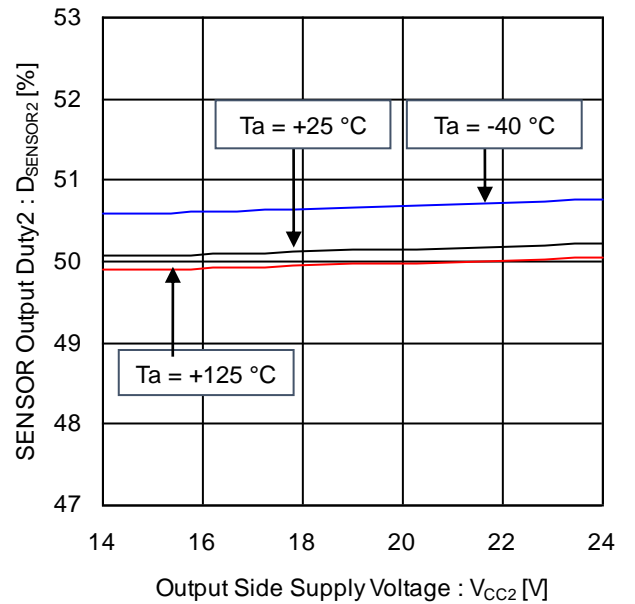

Figure 48. SENSOR Output Duty2 vs Output-side Supply Voltage  
( $V_{TO1} = V_{TO2} = 2.59 \text{ V}$ )

Typical Performance Curves - continued

(Reference data)

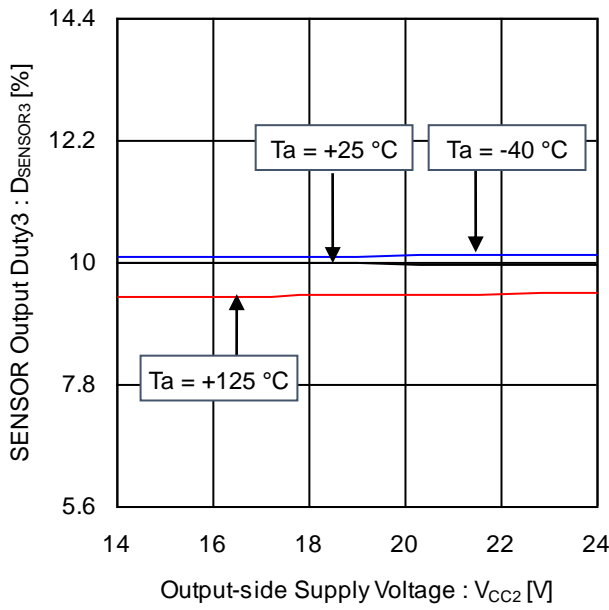

Figure 49. SENSOR Output Duty3 vs Output-side Supply Voltage ( $V_{TO1} = V_{TO2} = 3.84\text{ V}$ )

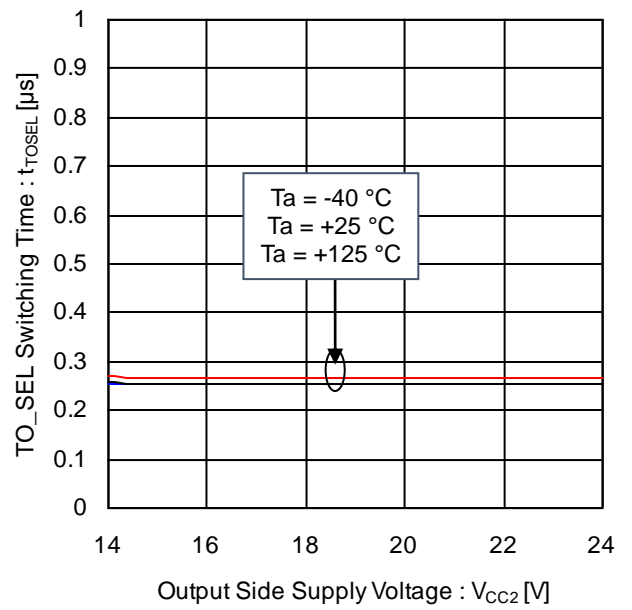

Figure 50. TO\_SEL Switching Time vs Output-side Supply Voltage

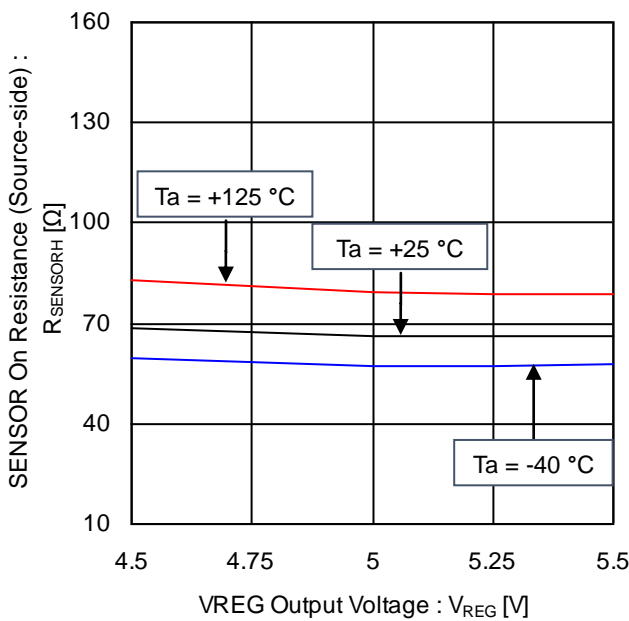

Figure 51. SENSOR On Resistance (Source-side) vs VREG Output Voltage ( $I_{SENSOR} = -5\text{ mA}$ )

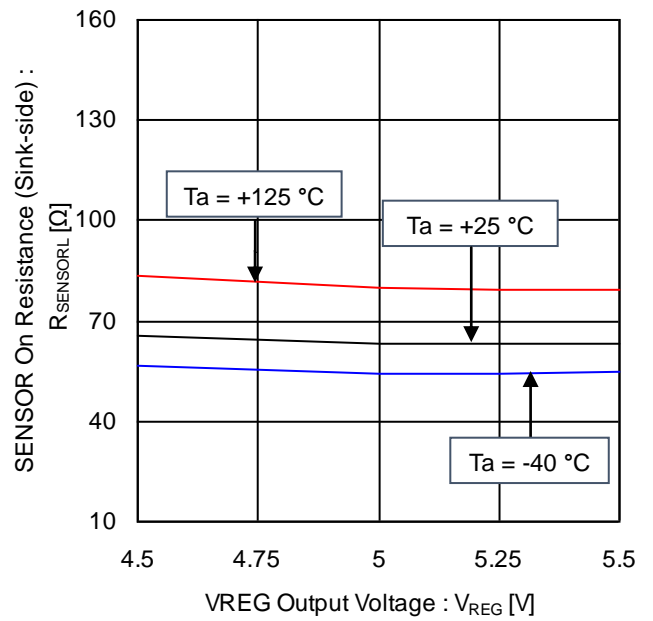

Figure 52. SENSOR On Resistance (Sink-side) vs VREG Output Voltage ( $I_{SENSOR} = +5\text{ mA}$ )

Typical Performance Curves - continued  
(Reference data)

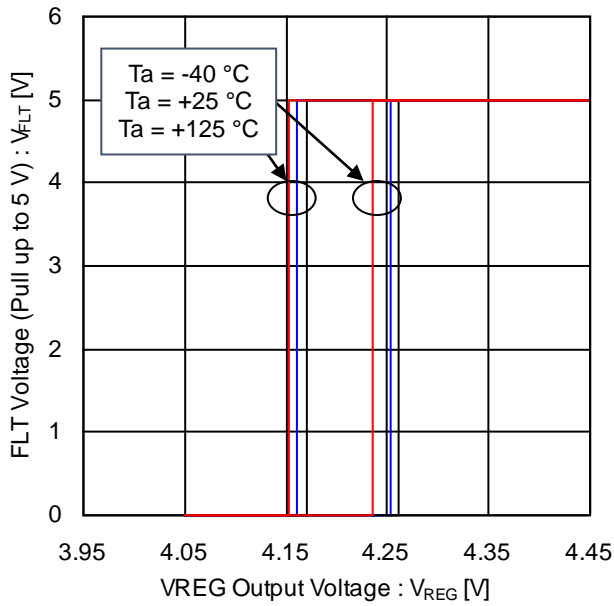

Figure 53. FLT Voltage vs VREG Output Voltage (VREG UVLO On / Off Voltage)

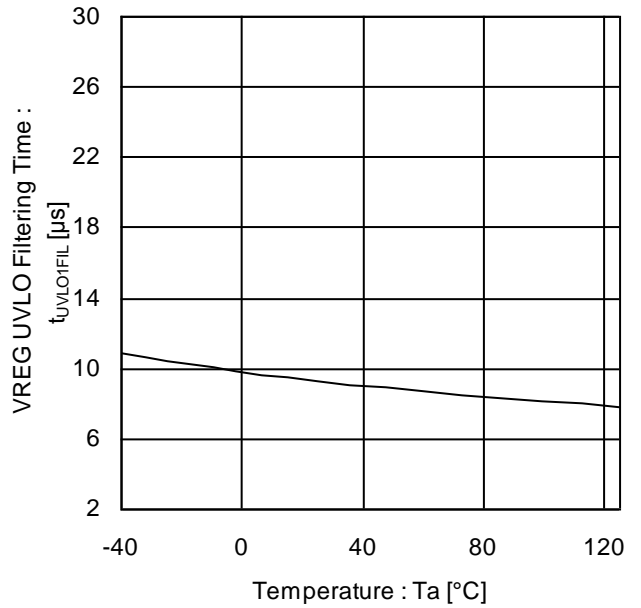

Figure 54. VREG UVLO Filtering Time vs Temperature

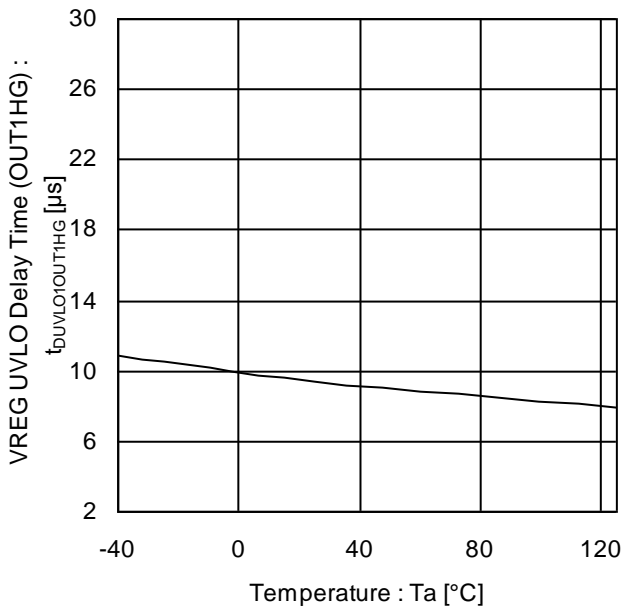

Figure 55. VREG UVLO Delay Time (OUT1HG) vs Temperature

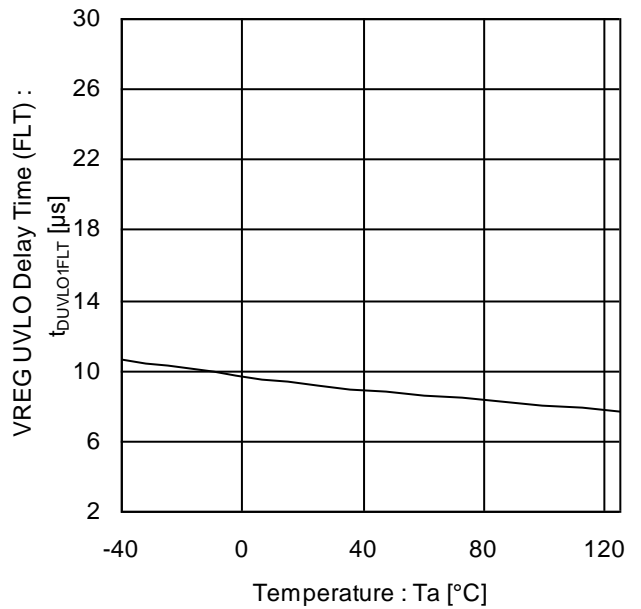

Figure 56. VREG UVLO Delay Time (FLT) vs Temperature

Typical Performance Curves - continued  
(Reference data)

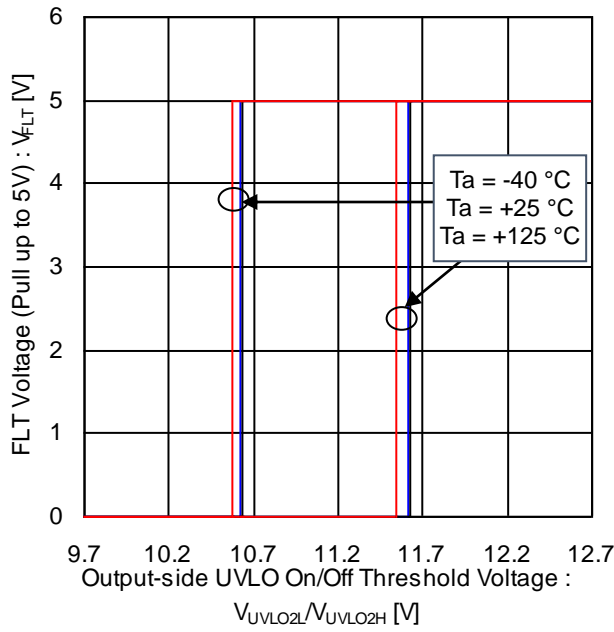

Figure 57. FLT Voltage vs Output-side UVLO On/Off Voltage

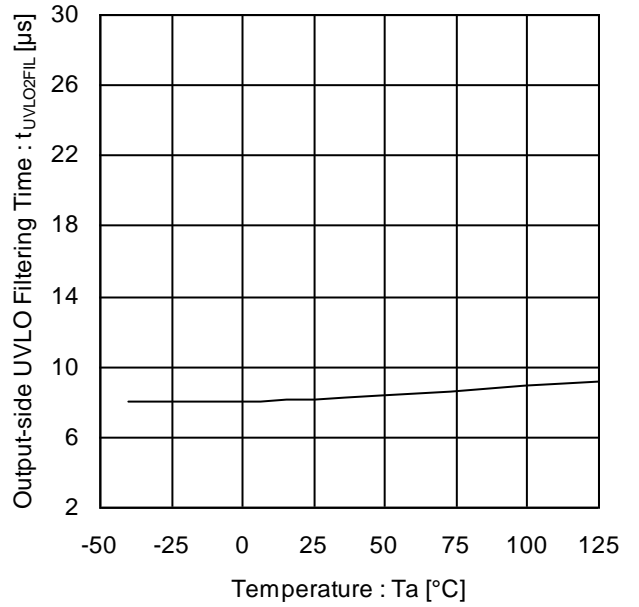

Figure 58. Output-side UVLO Filtering Time vs Temperature

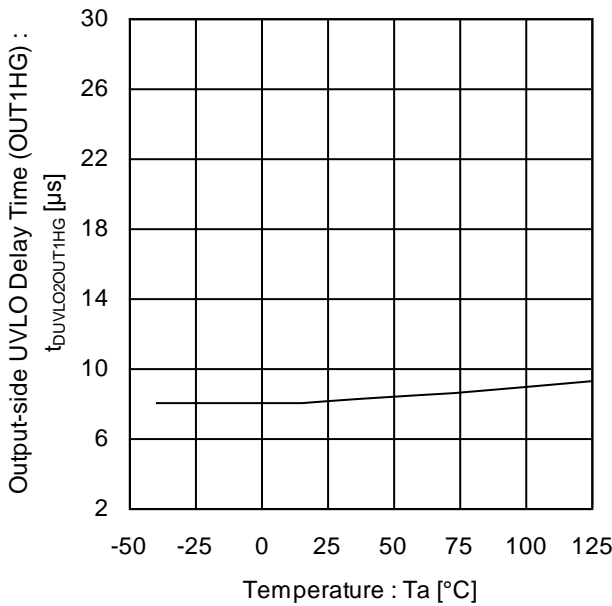

Figure 59. Output-side UVLO Delay Time (OUT1HG) vs Temperature

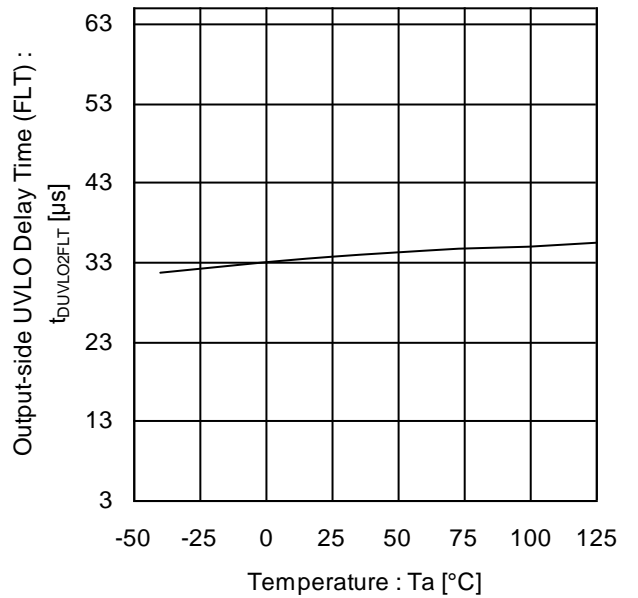

Figure 60. Output-side UVLO Delay Time (FLT) vs Temperature

Typical Performance Curves - continued  
(Reference data)

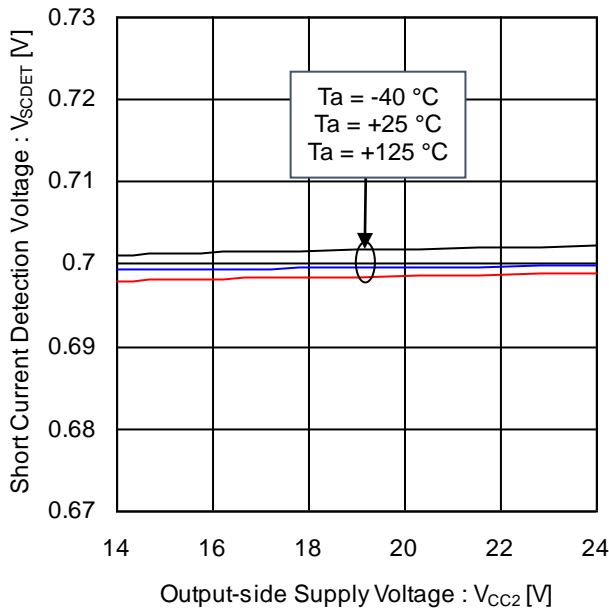

Figure 61. Short Current Detection Voltage vs Output-side Supply Voltage

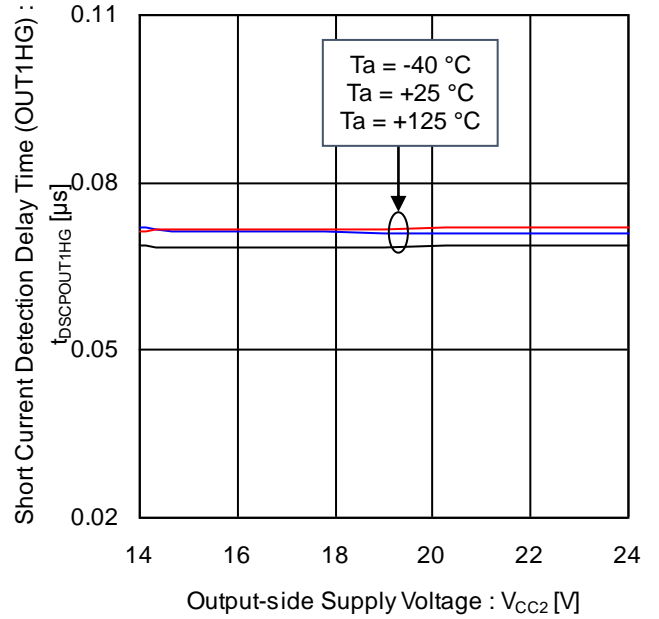

Figure 62. Short Current Detection Delay Time (OU1HG) vs Output-side Supply Voltage (OUT1HG = 1 kΩ Pull Up)

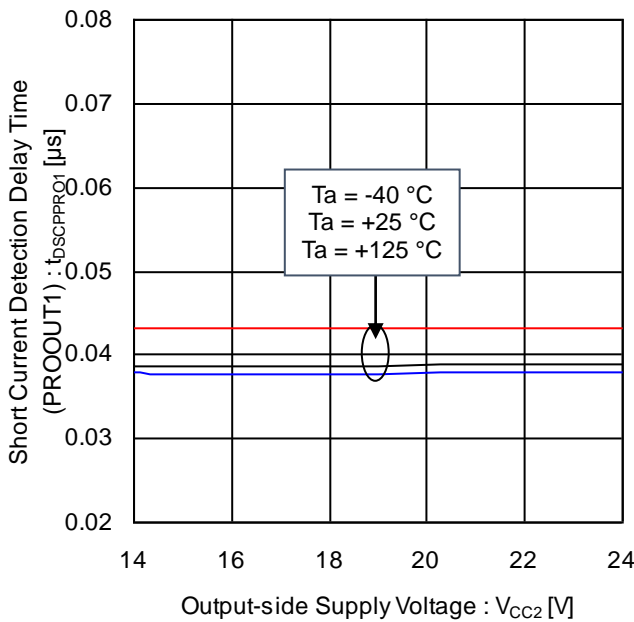

Figure 63. Short Current Detection Delay Time (PROOUT1) vs Output-side Supply Voltage

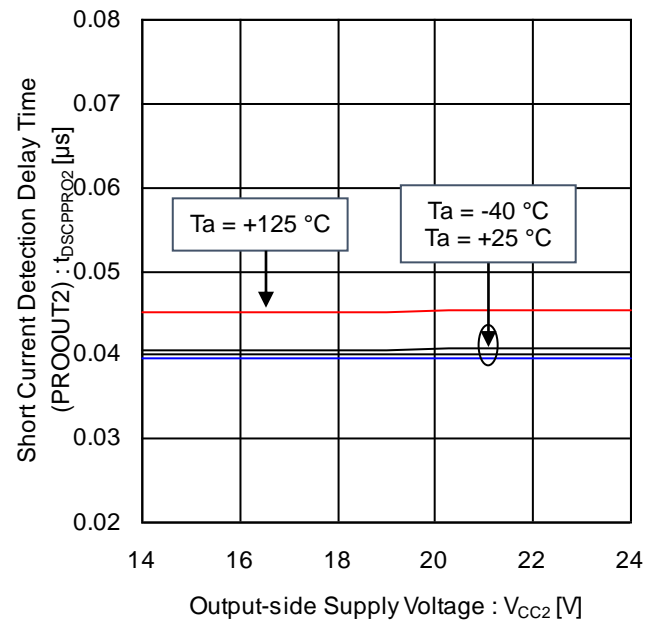

Figure 64. Short Current Detection Delay Time (PROOUT2) vs Output-side Supply Voltage



Typical Performance Curves - continued  
(Reference data)

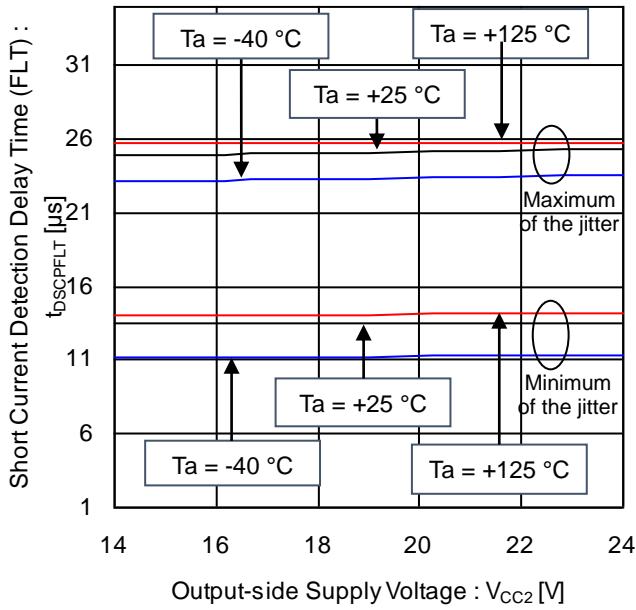

Figure 65. Short Current Detection Delay Time (FLT) vs Output-side Supply Voltage

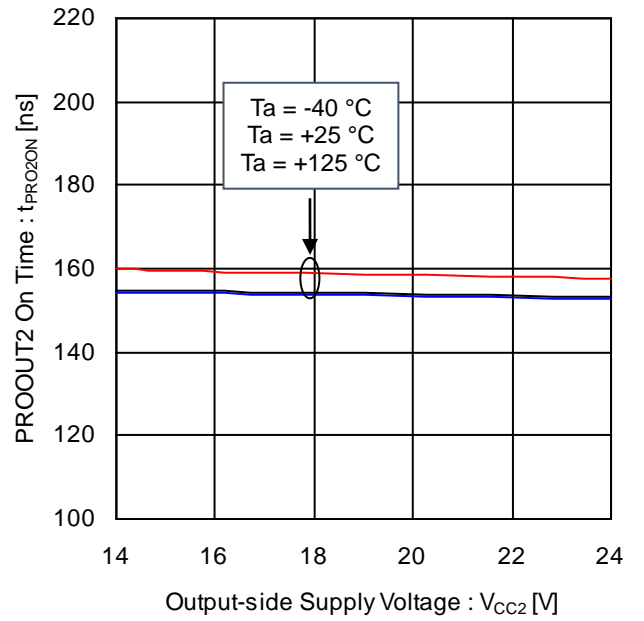

Figure 66. PROOUT2 On Time vs Output-side Supply Voltage

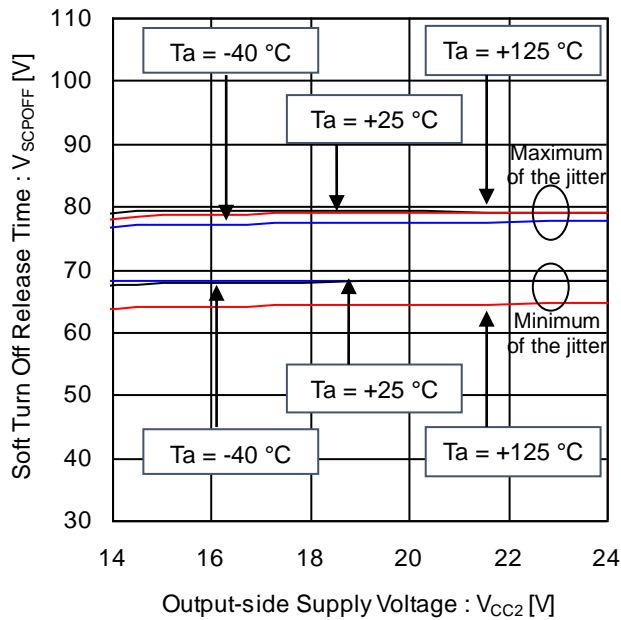

Figure 67. Soft Turn Off Release Time vs Output-side Supply Voltage

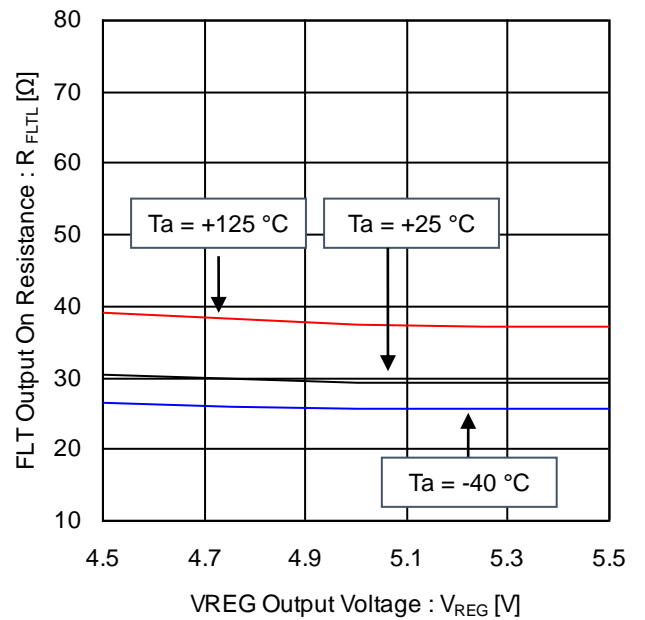

Figure 68. FLT Output On Resistance vs VREG Output Voltage (I<sub>FLT</sub> = 5 mA)

Typical Performance Curves - continued  
(Reference data)

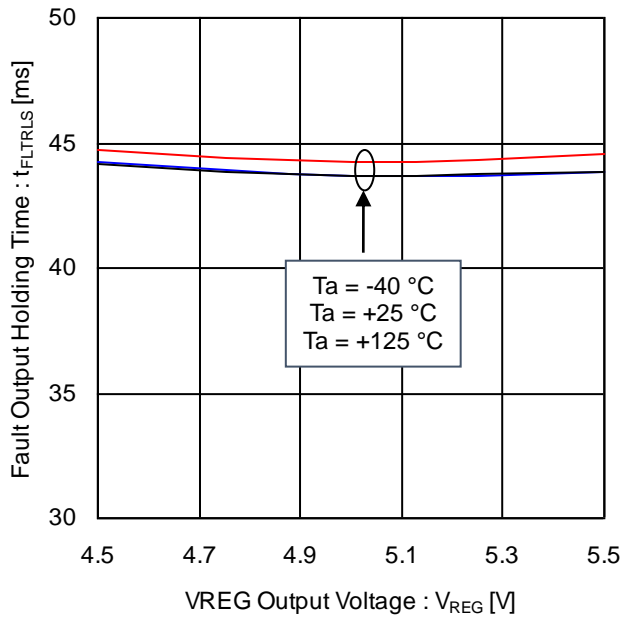

Figure 69. Fault Output Holding Time vs VREG Output Voltage

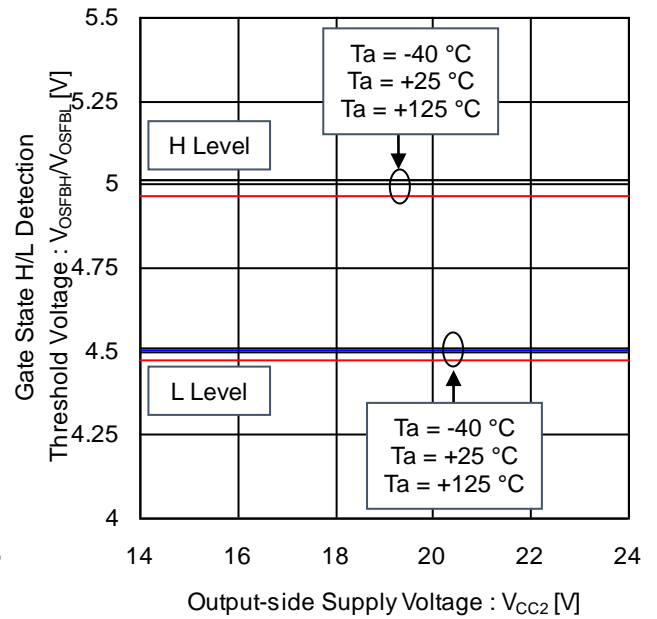

Figure 70. Gate State H/L Detection Threshold Voltage vs Output-side Supply Voltage

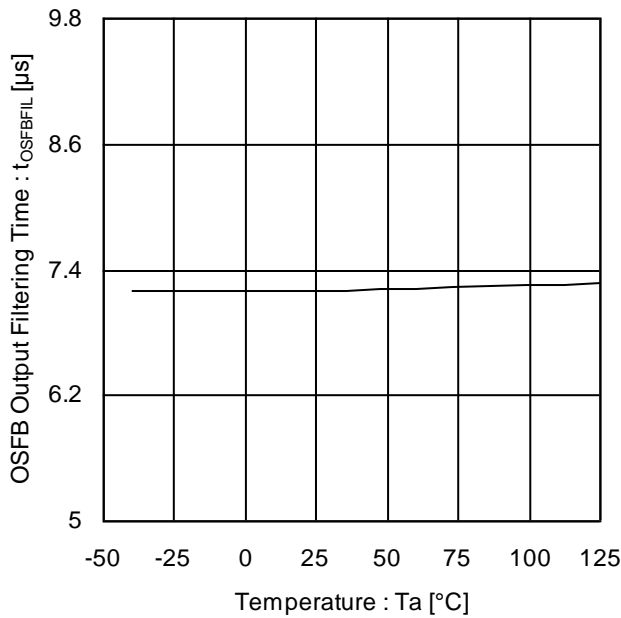

Figure 71. OSFB Output Filtering Time vs VREG Output Voltage

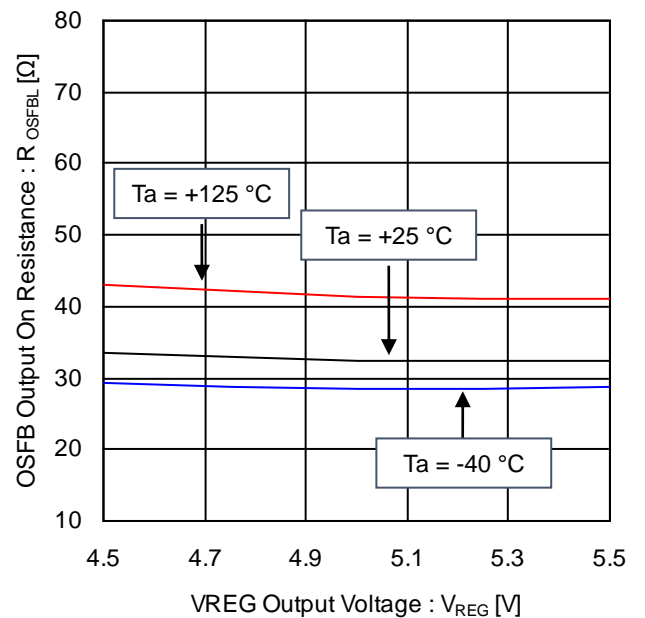

Figure 72. OSFB Output On Resistance vs VREG Output Voltage (I<sub>OSFB</sub> = 5 mA)

Typical Performance Curves - continued

(Reference data)

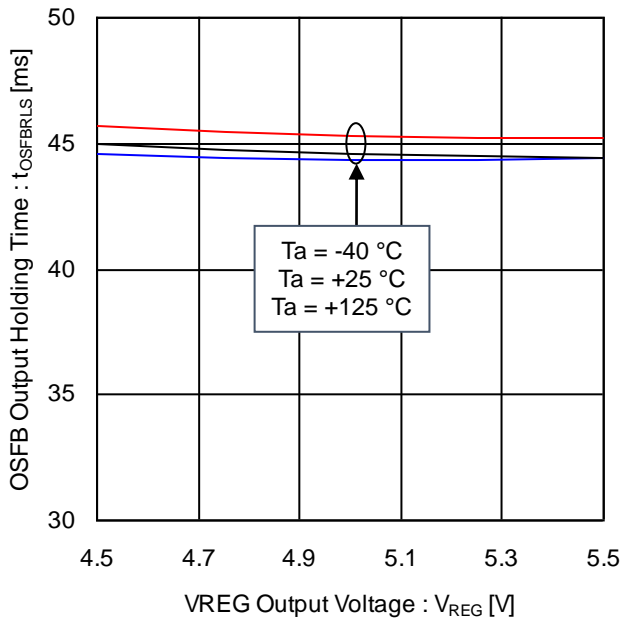

Figure 73. OSFB Output Holding Time vs VREG Output Voltage

UL1577 Ratings Table

Following values are described in UL Report.

Parameter	Value	Unit	Conditions
Side 1 (Input-side) Circuit Current	1.2	mA	V <sub>BATT</sub> = 14 V, OUT1HG = H, OUT1L = L
Side 2 (Output-side) Circuit Current	5.0	mA	V <sub>CC2</sub> = 15 V, OUT1HG = H, OUT1L = L
Side 1 (Input-side) Consumption Power	16.8	mW	V <sub>BATT</sub> = 14 V, OUT1HG = H, OUT1L = L
Side 2 (Output-side) Consumption Power	75	mW	V <sub>CC2</sub> = 15 V, OUT1HG = H, OUT1L = L
Isolation Voltage	2500	V <sub>rms</sub>	
Maximum Operating (Ambient) Temperature	125	°C	
Maximum Junction Temperature	150	°C	
Maximum Storage Temperature	150	°C	
Maximum Data Transmission Rate	1.3	MHz	

**Description of Pins and Cautions on Layout of Board**

1. V\_BATT (Main power supply pin)  
This is the main power supply pin. Connect a bypass capacitor between the V\_BATT pin and the GND1 pin in order to suppress voltage variations.
2. GND1 (Input-side ground pin)  
This is the ground pin on the input-side.
3. VCC2 (Output-side power supply pin)  
The VCC2 pin is a power supply pin on the output-side. To reduce voltage fluctuations due to the driving current of the internal transformer and output current, connect a bypass capacitor between the VCC2 pin and the GND2 pin.
4. GND2 (Output-side ground pin)  
This is the ground pin on the output-side. Connect the GND2 pin to the emitter/source of output device.
5. INA (Control input pin), DIS (Input enabling signal input pin)  
These are the pins for determining the output logic.

DIS	INA	OUT1HG	OUT1L
H	X	H	L
L	L	H	L
L	H	L	Hi-Z

X: Don't care

6. FLT (Fault output pin)  
The FLT pin is an open drain pin that sends a fault signal when a fault occurs (i.e., when the V\_BATT UVLO / VREG UVLO / VCC2 UVLO or short circuit protection function (SCP) is activated).

Status	FLT
Normal operation	Hi-Z
Fault	L

7. OSFB (Output state feedback output pin)  
This is an open drain pin which compares gate logic of the output device monitored with the PROOUT1 pin and the DIS or INA pin input logic, and outputs Low when they disaccord.

Status	DIS	INA	PROOUT1 (input)	OSFB
Normal operation	H	X	H	L
	H	X	L	Hi-Z
	L	L	H	L
	L	L	L	Hi-Z
	L	H	H	Hi-Z
	L	H	L	L
Fault	X	X	X	Hi-Z

X: Don't care

8. SENSOR (Temperature information output pin), TO\_SEL (Temperature information selecting pin)  
This is a pin which outputs the voltage of either the TO1 pin or TO2 pin converted to Duty cycle. The TO\_SEL pin determines which information to output, either the TO1 pin or TO2 pin.

TO_SEL	SENSOR Output
L	Output information of the TO1 pin
H	Output information of the TO2 pin

9. FB (Error amplifier inverting input pin for switching controller)  
This is a voltage feedback pin of the switching controller. Connect it to the VREG pin when the switching controller is not used.
10. COMP (Error amplifier output pin for switching controller)  
This is the gain control pin of the switching controller. Connect a phase compensation capacitor and resistor. When the switching controller is not used, connect it to the GND1 pin.

**Description of Pins and Cautions on Layout of Board - continued**

11. VREG (Input-side internal power supply pin)  
This is the internal power supply pin on the input side. Be sure to connect a capacitor between the VREG pin and the GND1 pin in order to prevent from oscillation and suppress voltage variation due to FET\_G output current and internal transformer driving current.  
It is also possible to supply voltage (4.5 V to 5.5 V) externally to the VREG pin. In this case, please short the VREG pin and the V\_BATT pin.
12. FET\_G (MOS FET for transformer drive control pin for switching controller)  
This is the MOS FET control pin for the switching controller transformer drive. Leave it open when the switching controller is not used.
13. SENSE (Current feedback resistor connection pin for switching controller)  
This is a pin connected to the resistor of the switching controller current feedback. Connect it to VREG when switching controller is not used.
14. OUT1HG (Source side MOS buffer driving pin)  
This is the buffer driving pin for gate on side. Connect it to the gate pin of the buffer (Pch MOS FET). Also, connect a resistor  $R_{OUT1HG}$  between the OUT1HG pin and the VCC2 pin to control the gate voltage of the buffer.
15. OUTREF (Reference voltage pin for constant current drive)  
This is the reference pin for gate constant current drive. Connect a resistor  $R_{OUTREF}$  between the VCC2 pin and the source pin of the buffer (Pch MOS FET). Also, connect the source pin of the buffer to the OUTREF pin.
16. OUT1L (Sink side output pin)  
This is the driving pin for gate off side.
17. OUT2 (Output pin for Miller Clamp)  
This is the miller clamp pin for preventing a rise of gate voltage. The OUT2 pin should be open when miller clamp function is not used.
18. PROOUT1 (Soft turn off pin for short circuit protection / Gate voltage input pin), PROOUT2 (Fast turn off pin for short circuit protection)  
This is a pin for soft turn off of output device when short-circuit protection is activated. Both the PROOUT1 pin and the PROOUT2 pin are turned on for  $t_{PRO2ON}$  from short circuit detection. After  $t_{PRO2ON}$ , only the PROOUT1 pin is turned on. It also functions as monitoring gate voltage pin for miller clamp function and output state feedback function.
19. SCPIN1, SCPIN2 (Short circuit detection pin)  
These are pins used to detect current for short circuit protection. When the SCPIN1 pin or the SCPIN2 pin voltage is more than  $V_{SCDET}$ , the SCP function is activated. There is a possibility of the IC malfunction in an open state. To avoid such trouble, short the SCPIN1 or SCPIN2 pin to the GND2 when the SCP function is not used.
20. TC (Resistor connection pin for setting constant current source output)  
The TC pin is a resistor connection pin for setting the constant current output for temperature monitor. If an arbitrary resistance value is connected between the TC pin and the GND2 pin, it is possible to set the constant current value output from the TO1 pin and the TO2 pin.
21. TO1, TO2 (Constant current output / Sensor voltage input pin)  
The TO1 pin and the TO2 pin are constant current output / sensor voltage input pins for temperature monitor. It can be used as a sensor input by connecting a device with arbitrary impedance between the TOx pin and the GND2. Furthermore, the TOx ( $x = 1$  or  $2$ ) pin disconnect detection function is built-in.

**Description of Functions and Examples of Constant Setting**

1. Fault Status Output

This function is used to output a fault signal from the FLT pin when a fault occurs (i.e., when the under voltage lockout function (UVLO) or short circuit protection function (SCP) is activated), after fault state cancellation, the FLT pin holds a fault signal until fault output holding time ( $t_{FLTRLS}$ ).

Status	FLT pin
Normal	Hi-Z
Fault occurs	L

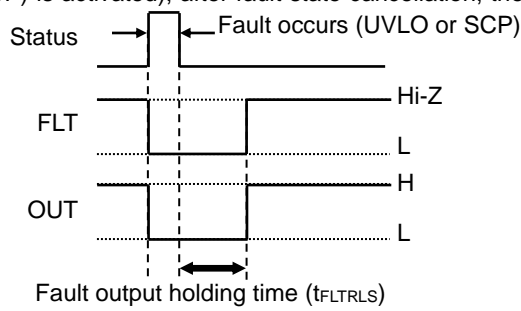

Figure 74. Fault Status Output Timing Chart

2. Under Voltage Lockout (UVLO) Function

The BM60059FV-C incorporates the under voltage lockout (UVLO) function on V\_BATT, VREG and VCC2. When the power supply voltage drops to the UVLO ON voltage, the OUT1HG pin outputs “H” signal and the OUT1L pin and the FLT pin both output the “L” signal. When the power supply voltage rises to the UVLO OFF voltage, these pins are reset. However, during the fault output holding time set in “Fault Status Output” section, the OUT1HG pin holds the “H” signal and the OUT1L pin and the FLT pin hold the “L” signal. In addition, to prevent miss-triggering due to noise, filtering time  $t_{UVLO1FIL}$  and  $t_{UVLO2FIL}$  are set on V\_BATT, VREG and VCC2.

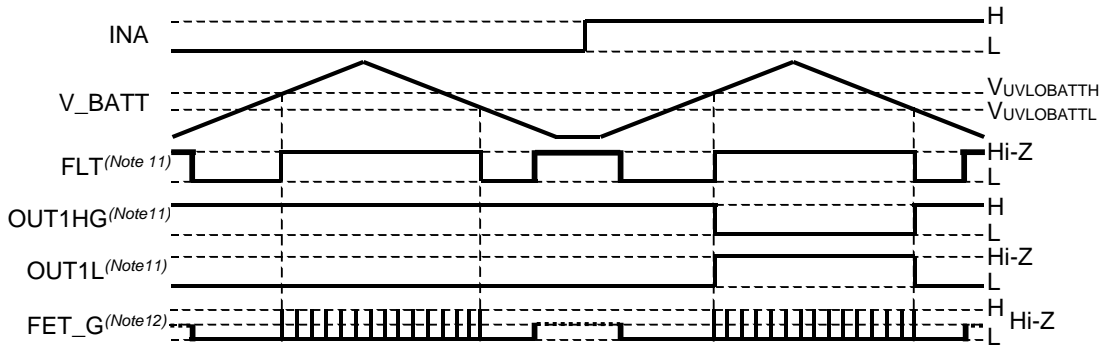

Figure 75. V\_BATT UVLO Function Operation Timing Chart



Figure 76. VREG UVLO Function Operation Timing Chart

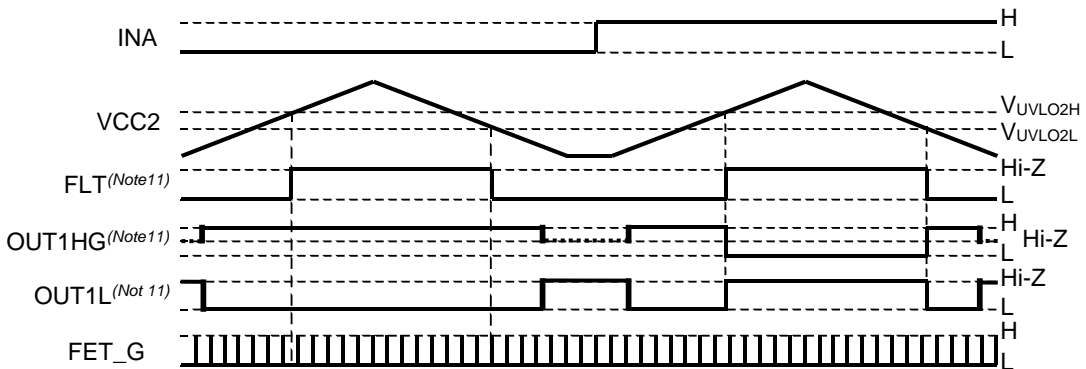

Figure 77. VCC2 UVLO Function Operation Timing Chart

(Note 11) The FLT pin, the OUT1HG pin and the OUTPUT1L pin start operation after fault output holding time.

(Note 12) The FET\_G pin starts operation immediately after UVLO reset.

**Description of Functions and Examples of Constant Setting - continued**

**3. Short Circuit Protection (SCP) Function**

When the SCPIN1 pin or the SCPIN2 pin voltage exceeds the  $V_{SCDET}$ , the SCP function is activated. When the SCP function is activated, the OUT1HG pin voltage is set to the "Hi-Z" level and the PROOUT1 pin, the PROOUT2 pin and the FLT pin voltage go to the "L" level first (Fast Turn Off). Next, after  $t_{PRO2ON}$  has passed from the Short Current Detection, the PROOUT2 pin is set to the "Hi-Z" level (Soft Turn Off). And then, when short-circuit current, the OUT1L pin becomes the "L" level. Finally, when the fault output holding time has elapsed, the SCP function is released and the FLT pin becomes the "Hi-Z" level. The PROOUT1 pin holds the "L" state until the OUT1HG pin becomes the "L" level.

Please take note that when the OUT1L pin is "L", the short-circuit is not detected.

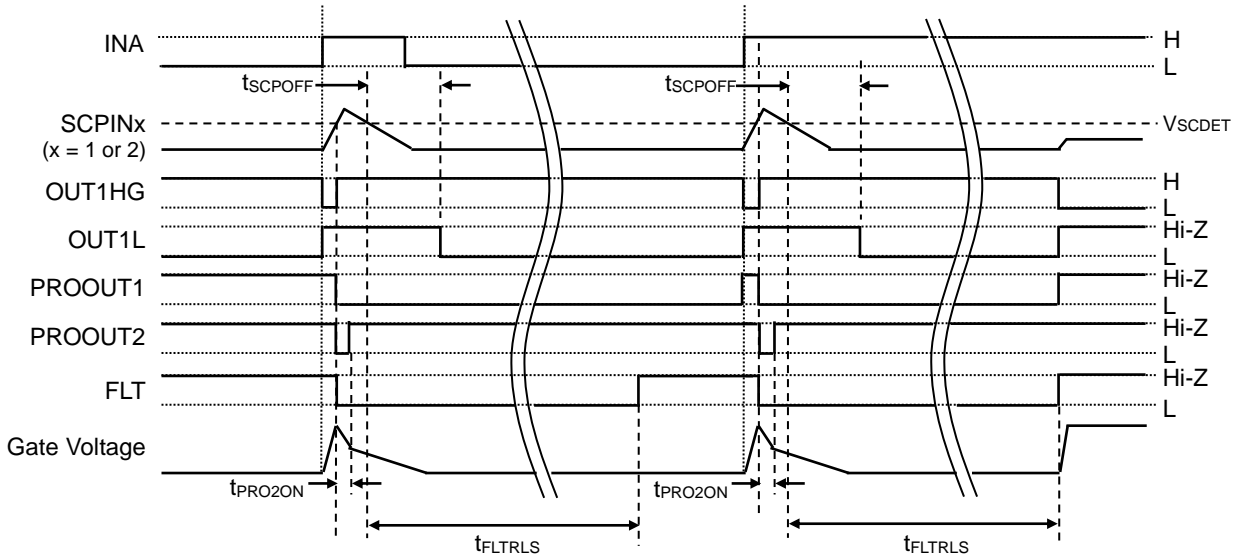

Figure 78. SCP Operation Timing Chart

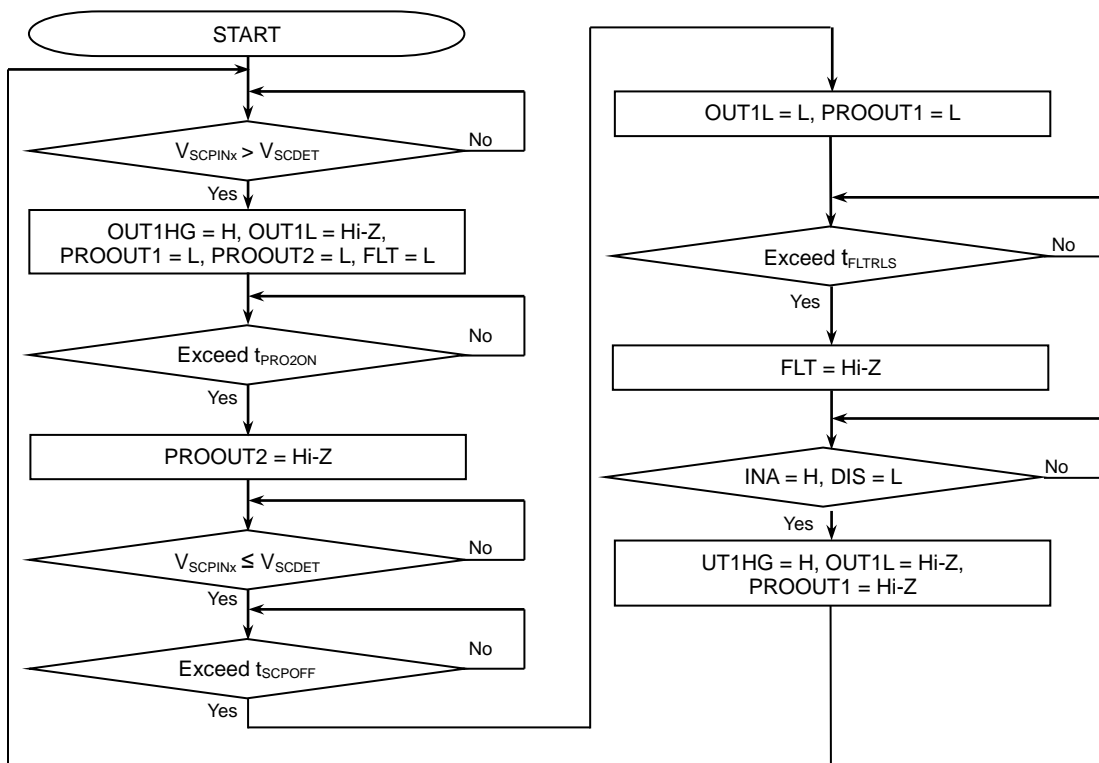

Figure 79. SCP Operation Status Transition Diagram

Description of Functions and Examples of Constant Setting - continued

4. Miller Clamp Function

When the OUT1HG pin = H, the OUT1 pin = L and the PROOUT1 pin voltage <  $V_{OUT2ON}$ , the internal MOS of the OUT2 pin is turned ON and the miller clamp function operates. This state is kept until the OUT1HG pin becomes L and the OUT1L pin becomes Hi-Z. While the short circuit protection function is activated, miller clamp function operates after the lapse of soft turn off release time  $t_{SCPOFF}$ .

Short current protection	SCPINx (x = 1 or 2)	INA	PROOUT1 Input	OUT2
Operated	$\geq V_{SCDET}$	X	X	Hi-Z
Not operated	X	L	$\geq V_{OUT2ON}$	Hi-Z
	X	L	$< V_{OUT2ON}$	L
	X	H	X	Hi-Z

X: Don't care

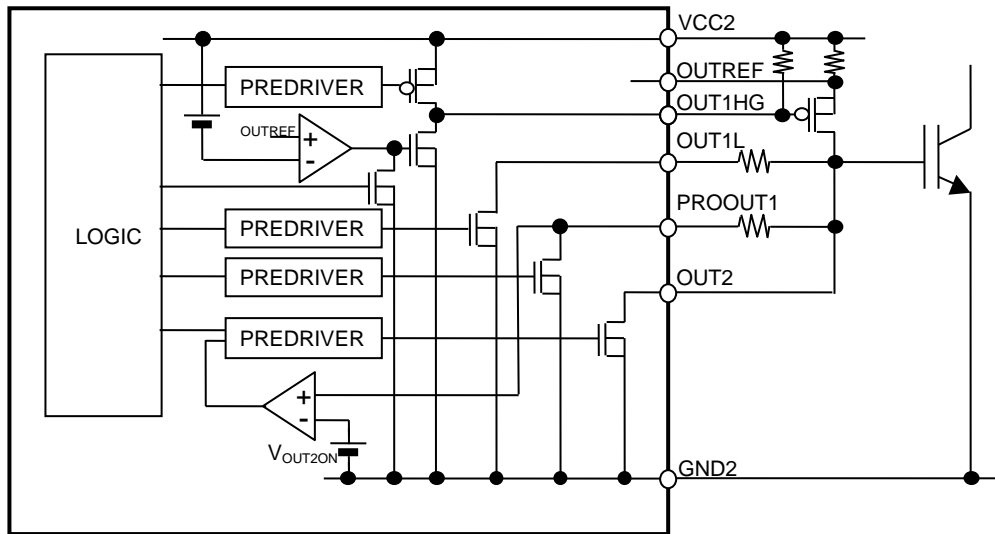

Figure 80. Block Diagram of Miller Clamp Function



Figure 81. Timing Chart of Miller Clamp Function

SCPINx: SCPIN1 or SCPIN2



**Description of Functions and Examples of Constant Setting - continued**

5. Gate Constant Current Driving Function

This IC has a gate constant current driving function. Charge the gate of the output element with a constant current by connecting buffer (Pch MOS FET M<sub>OUT1H</sub>) and resistors (R<sub>OUTREF</sub>, R<sub>OUT1HG</sub>) as shown in Figure 82. I<sub>GATE</sub> can be set using the following formula:

$$I_{GATE} [A] = V_{OUTREF} [V] / R_{OUTREF} [\Omega]$$

The table below shows the recommended components for the external parts (M<sub>OUT1H</sub>, R<sub>OUTREF</sub>, and R<sub>OUT1HG</sub>). If using other component for M<sub>OUT1H</sub> or using resistors outside the recommended range, please make sure that there is no overshoot or oscillation of the current in the operating temperature condition and current setting.

Symbol	Manufacturer	Recommended Components	Recommended Value		Unit
			Min	Max	
M <sub>OUT1H</sub>	ROHM	RSR015P06HZGTL	-	-	-
R <sub>OUTREF</sub>	ROHM	MCR Series LTR Series	0.34	-	Ω
R <sub>OUT1HG</sub>	ROHM		0.5	2.5	kΩ

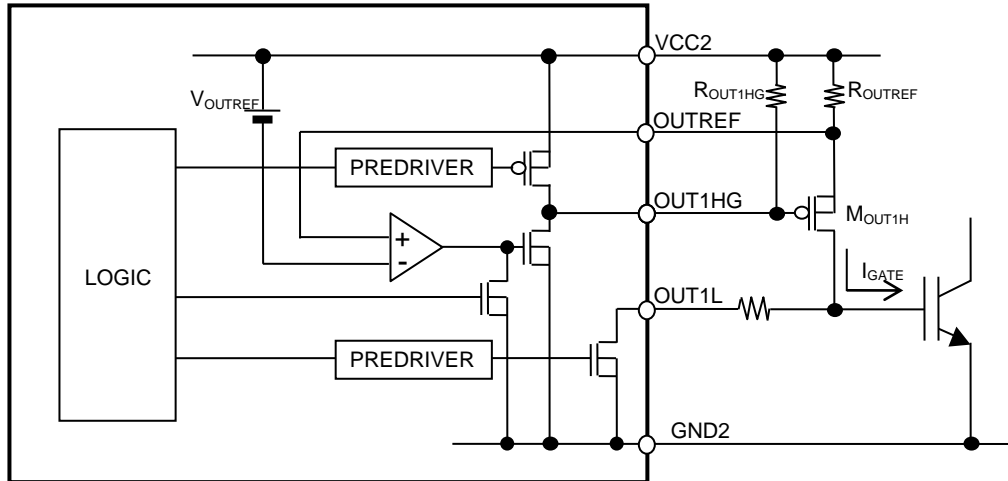

Figure 82. Block Diagram of Gate Constant Current Driving Function

**Description of Functions and Examples of Constant Setting - continued**

6. Output State Feedback Function

When the gate logic of output device monitored with the PROOUT1 pin and input logic are compared, and they are different, the OSFB pin outputs L. In order to prevent the detection error due to delay of input and output, OSFB filter time  $t_{OSFBON}$  is provided. After resolving the mismatch state, hold the OSFB to Low until OSFB output holding time ( $t_{OSFBRLS}$ ) is completed.

7. Switching Regulator

(1) Basic action

This IC has a switching controller which turns ON/OFF in synchronous with internal clock. When  $V_{BATT}$  voltage is supplied ( $V_{BATT} > V_{UVLOBATTH}$ ), the FET\_G pin starts switching by soft-start. Output voltage is determined by the following equation through the external resistance and winding ratio "n" of the flyback transformer ( $n = \text{Secondary side winding number} / \text{FB side winding number}$ ).

$$V_{OUT} = V_{FB} \times \{(R1 + R2) / R2\} \times n [V]$$

(2) Max Duty

When, for example, the output load is large and the voltage level of the SENSE pin does not reach current detection level, the output is forcibly turned off by Maximum On Duty ( $D_{ONMAX}$ ).

(3) Pin conditions when switching controller is not used

Implement pin setting as shown below when switching controller is not used.

Pin Number	Pin Name	Treatment Method
22	FB	Connect to VREG
23	COMP	Connect to GND1
24	V_BATT	Connect to power supply
25	VREG	Connect a capacitor
26	FET_G	No connection
27	SENSE	Connect to VREG

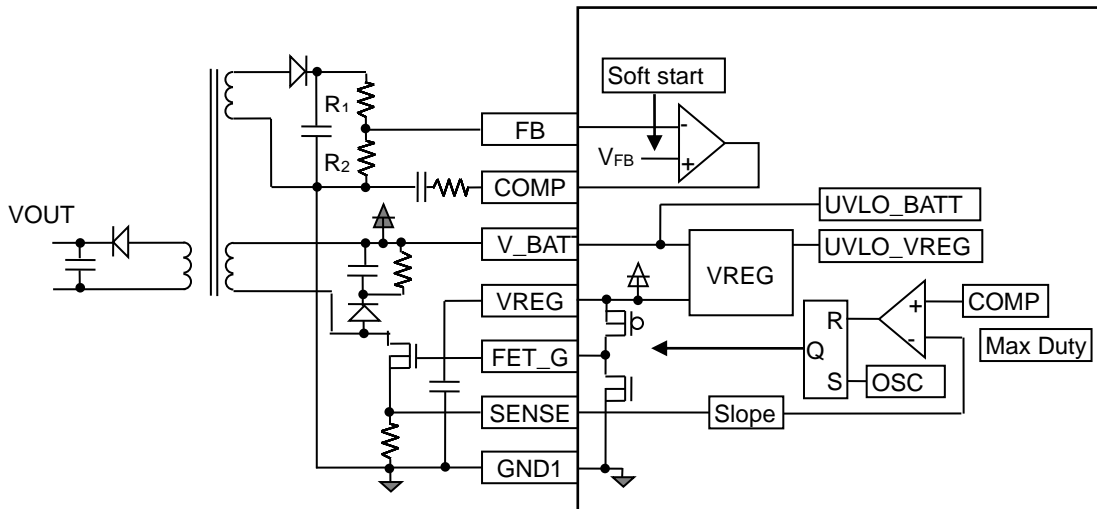

Figure 83. Block Diagram of Switching Controller

Description of Functions and Examples of Constant Setting - continued

8. Temperature Monitor Function

This IC has a built-in constant current output circuit that supplies a constant current output from the TO1 and TO2 pins. The current value  $I_{TO}$  can be adjusted depending on the resistance value connected between the TC pin and the GND2 pin. Furthermore, the TO1 pin and the TO2 pin have voltage input function. The SENSOR pin outputs the signal of the TO1 pin or the TO2 pin voltage converted to Duty. The TO\_SEL pin determines which output is selected whether the TO1 pin or the TO2 pin. When TO\_SEL = Low, the TO1 pin is selected. When TO\_SEL = High, the TO2 pin is selected. When only one of the TO1 or the TO2 pin is used, connect the other TOx pin to GND2. (x = 1 or 2)

$$I_{TO} [mA] = 10 \times V_{TC} [V] / R_{TC} [k\Omega]$$

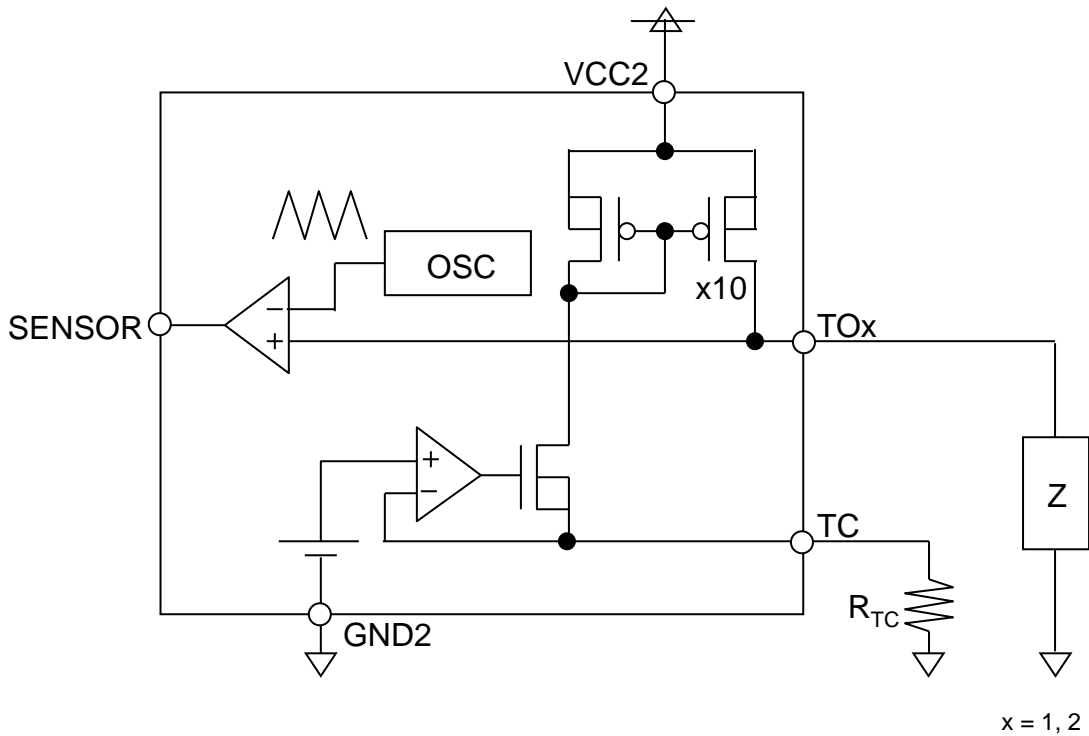

Figure 84. Block Diagram of Temperature Monitor Function

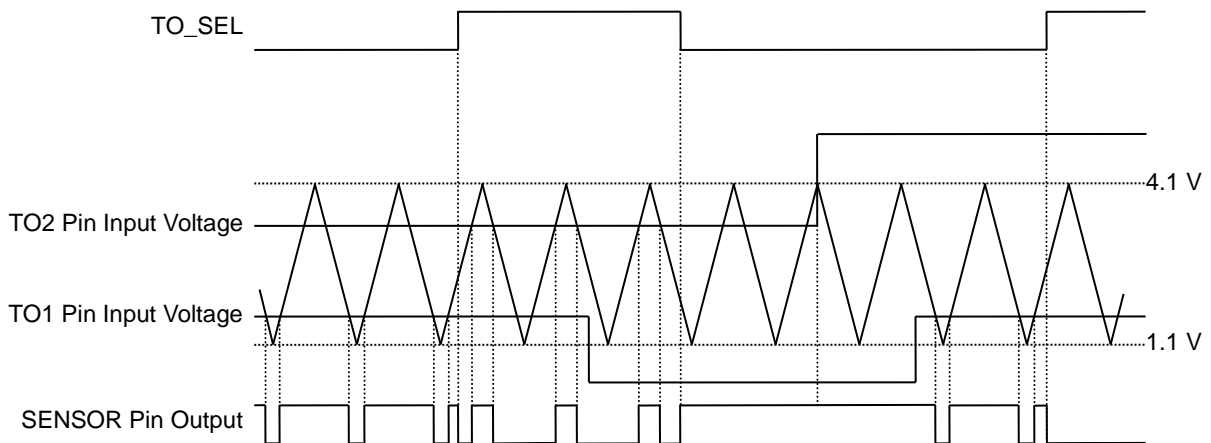

Figure 85. Timing Chart of Temperature Monitor Function

## Description of Functions and Examples of Constant Setting - continued

## 9. I/O Condition Table

No	Status	Input							Output						
		VREG	UVLOIN	V_BATT	SCPINx	DIS	INA	PROOUT1 Input	OUT1HG	OUT1L	OUT2	PROOUT1	PROOUT2	FLT	OSFB
1	SCP	○	○	○	H	L	H	X	H	Z	Z	L	L→Z	L	Z
2	VREG UVLO	UVLO	X	X	L	X	X	H	H	L	Z	Z	Z	L	Z
3		UVLO	X	X	L	X	X	L	H	L	L	Z	Z	L	Z
4	VCC2 UVLO	X	UVLO	X	L	X	X	H	H	L	Z	Z	Z	L	Z
5		X	UVLO	X	L	X	X	L	H	L	L	Z	Z	L	Z
6	V_BATT UVLO	X	X	UVLO	L	X	X	H	H	L	Z	Z	Z	L	Z
7		X	X	UVLO	L	X	X	L	H	L	L	Z	Z	L	Z
8	Disable	○	○	○	L	H	X	H	H	L	Z	Z	Z	Z	L
9		○	○	○	L	H	X	L	H	L	L	Z	Z	Z	Z
10	Normal Operation L Input	○	○	○	L	L	L	H	H	L	Z	Z	Z	Z	L
11		○	○	○	L	L	L	L	H	L	L	Z	Z	Z	Z
12	Normal Operation H Input	○	○	○	L	L	H	H	L	Z	Z	Z	Z	Z	Z
13		○	○	○	L	L	H	L	L	Z	Z	Z	Z	Z	L

SCPINx: SCPIN1 or SCPIN2, ○: Power supply voltage > UVLO, X: Don't care, Z: Hi-Z

**Selection of Components Externally Connected**

The following are the recommended external components.

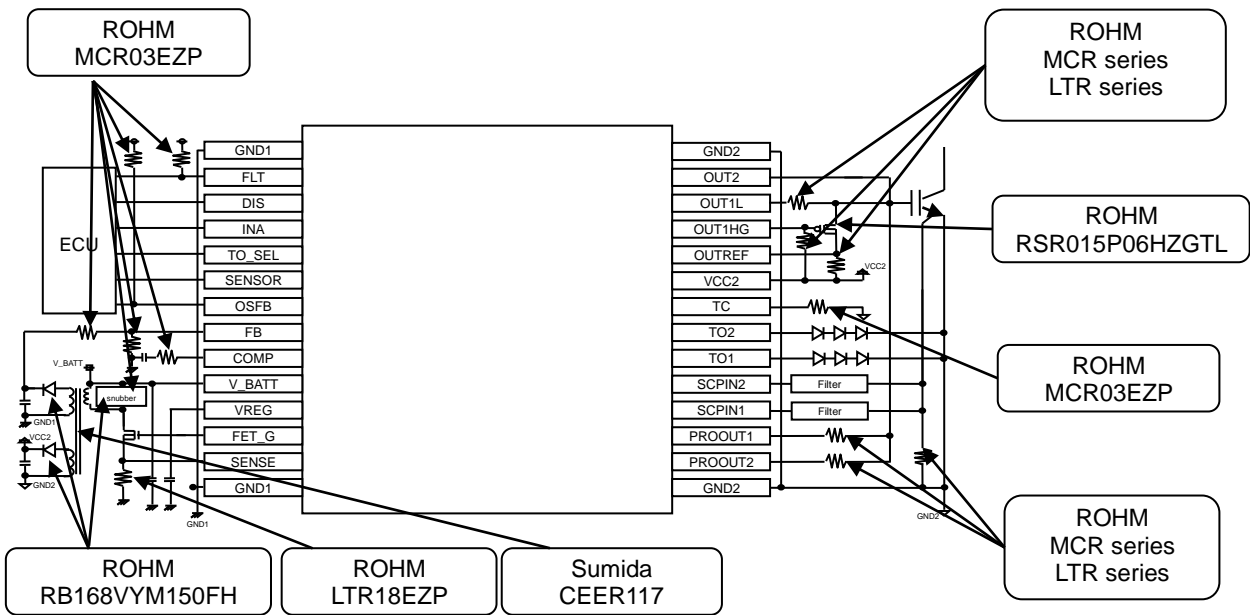

I/O Equivalence Circuits

Pin No.	Pin Name	Input Output Equivalent Circuit Diagram
	Pin Function	
4	SCPIN1	
	Short circuit detection pin 1	
5	SCPIN2	
	Short circuit detection pin 2	
6	TO1	
	Constant current output pin / Sensor voltage input pin 1	
7	TO2	
	Constant current output pin / Sensor voltage input pin 2	
8	TC	
	Resistor connection pin for setting constant current source output	
10	OUTREF	
	Reference voltage pin for constant current drive	

I/O Equivalence Circuits - continued

Pin No.	Pin Name	Input Output Equivalent Circuit Diagram
	Pin Function	
11	OUT1HG	
	Source side MOS buffer driving pin	
12	OUT1L	
	Sink side output pin	
13	OUT2	
	Output pin for Miller Clamp	
2	PROOUT2	
	Fast turn off pin for short circuit protection	
3	PROOUT1	
	Soft turn off pin for short circuit protection / Gate voltage input pin	
16	FLT	
	Fault output pin	
21	OSFB	
	Output state feedback output pin	
20	SENSOR	
	Temperature information output pin	

I/O Equivalence Circuits - continued

Pin No.	Pin Name	Input Output Equivalent Circuit Diagram
	Pin Function	
17	DIS	
	Input enabling signal input pin	
18	INA	
	Control input pin	
19	TO_SEL	
	Temperature information selecting pin	
22	FB	
	Error amplifier inverting input pin for switching controller	
23	COMP	
	Error amplifier output pin for switching controller	



I/O Equivalence Circuits - continued

Pin No.	Pin Name	Input Output Equivalent Circuit Diagram
	Pin Function	
25	VREG	
	Input-side internal power supply pin	
26	FET_G	
	MOS FET for transformer drive control pin for switching controller	
27	SENSE	
	Current feedback resistor connection pin for switching controller	

## Operational Notes

### 1. Reverse Connection of Power Supply

Connecting the power supply in reverse polarity can damage the IC. Take precautions against reverse polarity when connecting the power supply, such as mounting an external diode between the power supply and the IC's power supply pins.

### 2. Power Supply Lines

Design the PCB layout pattern to provide low impedance supply lines. Furthermore, connect a capacitor to ground at all power supply pins. Consider the effect of temperature and aging on the capacitance value when using electrolytic capacitors.

### 3. Ground Voltage

Ensure that no pins are at a voltage below that of the ground pin at any time, even during transient condition.

### 4. Ground Wiring Pattern

When using both small-signal and large-current ground traces, the two ground traces should be routed separately but connected to a single ground at the reference point of the application board to avoid fluctuations in the small-signal ground caused by large currents. Also ensure that the ground traces of external components do not cause variations on the ground voltage. The ground lines must be as short and thick as possible to reduce line impedance.

### 5. Recommended Operating Conditions

The function and operation of the IC are guaranteed within the range specified by the recommended operating conditions. The characteristic values are guaranteed only under the conditions of each item specified by the electrical characteristics.

### 6. Inrush Current

When power is first supplied to the IC, it is possible that the internal logic may be unstable and inrush current may flow instantaneously due to the internal powering sequence and delays, especially if the IC has more than one power supply. Therefore, give special consideration to power coupling capacitance, power wiring, width of ground wiring, and routing of connections.

### 7. Testing on Application Boards

When testing the IC on an application board, connecting a capacitor directly to a low-impedance output pin may subject the IC to stress. Always discharge capacitors completely after each process or step. The IC's power supply should always be turned off completely before connecting or removing it from the test setup during the inspection process. To prevent damage from static discharge, ground the IC during assembly and use similar precautions during transport and storage.

Operational Notes – continued

8. Inter-pin Short and Mounting Errors

Ensure that the direction and position are correct when mounting the IC on the PCB. Incorrect mounting may result in damaging the IC. Avoid nearby pins being shorted to each other especially to ground, power supply and output pin. Inter-pin shorts could be due to many reasons such as metal particles, water droplets (in very humid environment) and unintentional solder bridge deposited in between pins during assembly to name a few.

9. Unused Input Pins

Input pins of an IC are often connected to the gate of a MOS transistor. The gate has extremely high impedance and extremely low capacitance. If left unconnected, the electric field from the outside can easily charge it. The small charge acquired in this way is enough to produce a significant effect on the conduction through the transistor and cause unexpected operation of the IC. So unless otherwise specified, unused input pins should be connected to the power supply or ground line.

10. Regarding the Input Pin of the IC

This IC contains P+ isolation and P substrate layers between adjacent elements in order to keep them isolated. P-N junctions are formed at the intersection of the P layers with the N layers of other elements, creating a parasitic diode or transistor. For example (refer to figure below):

When  $GND > Pin A$  and  $GND > Pin B$ , the P-N junction operates as a parasitic diode.  
 When  $GND > Pin B$ , the P-N junction operates as a parasitic transistor.

Parasitic diodes inevitably occur in the structure of the IC. The operation of parasitic diodes can result in mutual interference among circuits, operational faults, or physical damage. Therefore, conditions that cause these diodes to operate, such as applying a voltage lower than the GND voltage to an input pin (and thus to the P substrate) should be avoided.

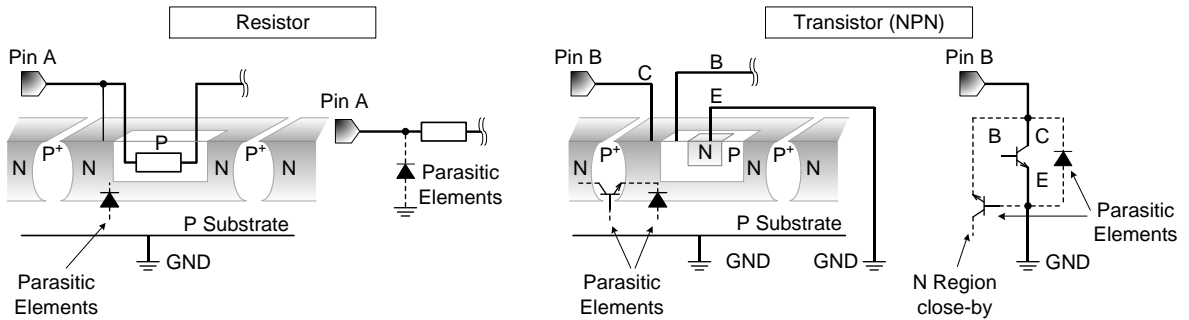
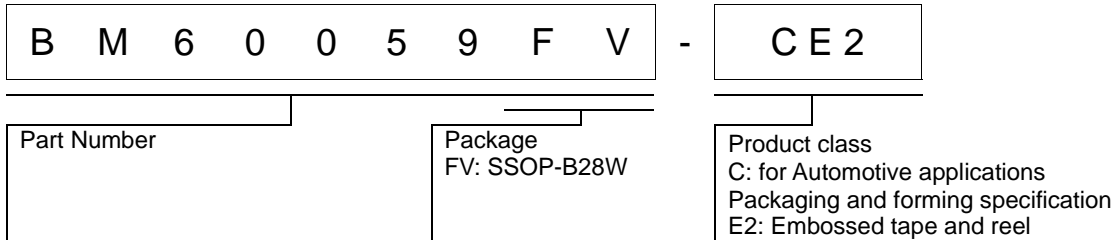

Figure 86. Example of IC Structure

11. Ceramic Capacitor

When using a ceramic capacitor, determine a capacitance value considering the change of capacitance with temperature and the decrease in nominal capacitance due to DC bias and others.

Ordering Information



Marking Diagram

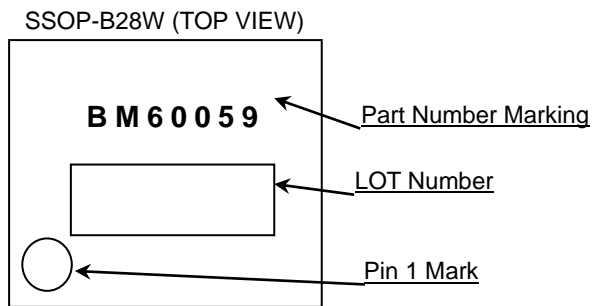

Physical Dimension and Packing Information

Package Name	SSOP-B28W
--------------	-----------

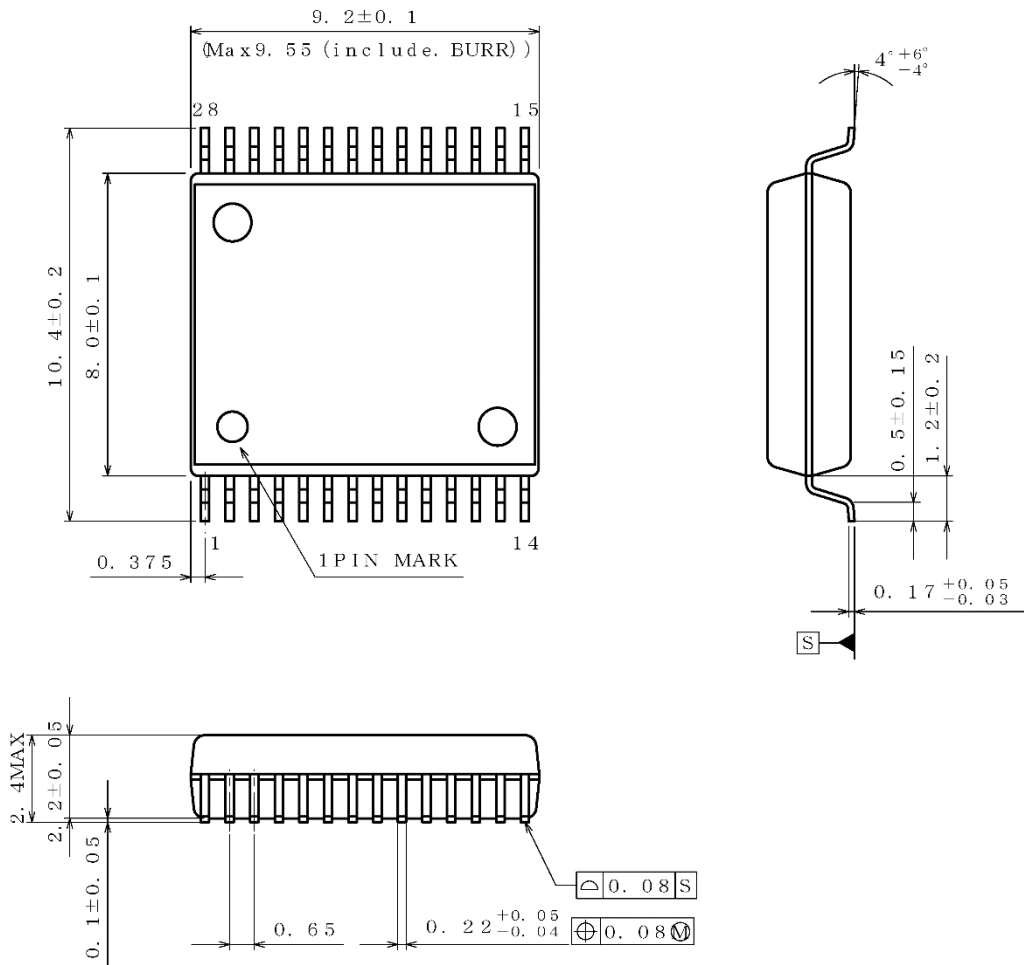

(UNIT : mm)  
 PKG : SSOP-B28W  
 Drawing No. EX072-5002

< Tape and Reel Information >

Tape	Embossed carrier tape
Quantity	1500pcs
Direction of feed	E2 The direction is the pin 1 of product is at the upper left when you hold reel on the left hand and you pull out the tape on the right hand

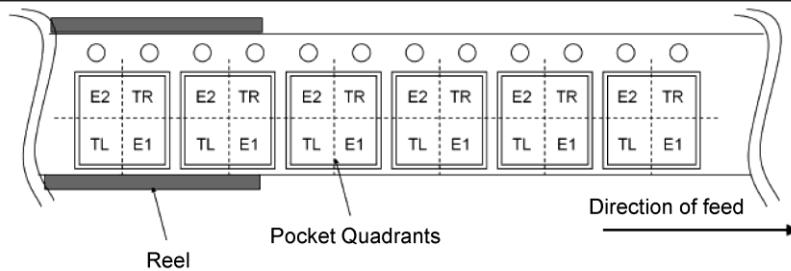

## Revision History

Date	Revision	Changes
29.Nov.2019	001	New Release
28.Jul.2021	002	Page 1 Added "UL1577 Recognized" in the Features column Page 4 Changed from "power dissipation" to "thermal resistance" in the Caution 2 Page 5 Changed Vcc2 Recommended Operating Condition Page 6 Changed Vcc2 condition in the Electrical Characteristics Page 27 Added UL1577 Rating Tables

# Notice

## Precaution on using ROHM Products

1. If you intend to use our Products in devices requiring extremely high reliability (such as medical equipment <sup>(Note 1)</sup>, aircraft/spacecraft, nuclear power controllers, etc.) and whose malfunction or failure may cause loss of human life, bodily injury or serious damage to property ("Specific Applications"), please consult with the ROHM sales representative in advance. Unless otherwise agreed in writing by ROHM in advance, ROHM shall not be in any way responsible or liable for any damages, expenses or losses incurred by you or third parties arising from the use of any ROHM's Products for Specific Applications.

(Note1) Medical Equipment Classification of the Specific Applications

JAPAN	USA	EU	CHINA
CLASS III	CLASS III	CLASS II b	CLASS III
CLASS IV		CLASS III	

2. ROHM designs and manufactures its Products subject to strict quality control system. However, semiconductor products can fail or malfunction at a certain rate. Please be sure to implement, at your own responsibilities, adequate safety measures including but not limited to fail-safe design against the physical injury, damage to any property, which a failure or malfunction of our Products may cause. The following are examples of safety measures:
  - [a] Installation of protection circuits or other protective devices to improve system safety
  - [b] Installation of redundant circuits to reduce the impact of single or multiple circuit failure
3. Our Products are not designed under any special or extraordinary environments or conditions, as exemplified below. Accordingly, ROHM shall not be in any way responsible or liable for any damages, expenses or losses arising from the use of any ROHM's Products under any special or extraordinary environments or conditions. If you intend to use our Products under any special or extraordinary environments or conditions (as exemplified below), your independent verification and confirmation of product performance, reliability, etc. prior to use, must be necessary:
  - [a] Use of our Products in any types of liquid, including water, oils, chemicals, and organic solvents
  - [b] Use of our Products outdoors or in places where the Products are exposed to direct sunlight or dust
  - [c] Use of our Products in places where the Products are exposed to sea wind or corrosive gases, including Cl<sub>2</sub>, H<sub>2</sub>S, NH<sub>3</sub>, SO<sub>2</sub>, and NO<sub>2</sub>
  - [d] Use of our Products in places where the Products are exposed to static electricity or electromagnetic waves
  - [e] Use of our Products in proximity to heat-producing components, plastic cords, or other flammable items
  - [f] Sealing or coating our Products with resin or other coating materials
  - [g] Use of our Products without cleaning residue of flux (Exclude cases where no-clean type fluxes is used. However, recommend sufficiently about the residue.); or Washing our Products by using water or water-soluble cleaning agents for cleaning residue after soldering
  - [h] Use of the Products in places subject to dew condensation
4. The Products are not subject to radiation-proof design.
5. Please verify and confirm characteristics of the final or mounted products in using the Products.
6. In particular, if a transient load (a large amount of load applied in a short period of time, such as pulse, is applied, confirmation of performance characteristics after on-board mounting is strongly recommended. Avoid applying power exceeding normal rated power; exceeding the power rating under steady-state loading condition may negatively affect product performance and reliability.
7. De-rate Power Dissipation depending on ambient temperature. When used in sealed area, confirm that it is the use in the range that does not exceed the maximum junction temperature.
8. Confirm that operation temperature is within the specified range described in the product specification.
9. ROHM shall not be in any way responsible or liable for failure induced under deviant condition from what is defined in this document.

## Precaution for Mounting / Circuit board design

1. When a highly active halogenous (chlorine, bromine, etc.) flux is used, the residue of flux may negatively affect product performance and reliability.
2. In principle, the reflow soldering method must be used on a surface-mount products, the flow soldering method must be used on a through hole mount products. If the flow soldering method is preferred on a surface-mount products, please consult with the ROHM representative in advance.

For details, please refer to ROHM Mounting specification

### Precautions Regarding Application Examples and External Circuits

1. If change is made to the constant of an external circuit, please allow a sufficient margin considering variations of the characteristics of the Products and external components, including transient characteristics, as well as static characteristics.
2. You agree that application notes, reference designs, and associated data and information contained in this document are presented only as guidance for Products use. Therefore, in case you use such information, you are solely responsible for it and you must exercise your own independent verification and judgment in the use of such information contained in this document. ROHM shall not be in any way responsible or liable for any damages, expenses or losses incurred by you or third parties arising from the use of such information.

### Precaution for Electrostatic

This Product is electrostatic sensitive product, which may be damaged due to electrostatic discharge. Please take proper caution in your manufacturing process and storage so that voltage exceeding the Products maximum rating will not be applied to Products. Please take special care under dry condition (e.g. Grounding of human body / equipment / solder iron, isolation from charged objects, setting of Ionizer, friction prevention and temperature / humidity control).

### Precaution for Storage / Transportation

1. Product performance and soldered connections may deteriorate if the Products are stored in the places where:
  - [a] the Products are exposed to sea winds or corrosive gases, including Cl<sub>2</sub>, H<sub>2</sub>S, NH<sub>3</sub>, SO<sub>2</sub>, and NO<sub>2</sub>
  - [b] the temperature or humidity exceeds those recommended by ROHM
  - [c] the Products are exposed to direct sunshine or condensation
  - [d] the Products are exposed to high Electrostatic
2. Even under ROHM recommended storage condition, solderability of products out of recommended storage time period may be degraded. It is strongly recommended to confirm solderability before using Products of which storage time is exceeding the recommended storage time period.
3. Store / transport cartons in the correct direction, which is indicated on a carton with a symbol. Otherwise bent leads may occur due to excessive stress applied when dropping of a carton.
4. Use Products within the specified time after opening a humidity barrier bag. Baking is required before using Products of which storage time is exceeding the recommended storage time period.

### Precaution for Product Label

A two-dimensional barcode printed on ROHM Products label is for ROHM's internal use only.

### Precaution for Disposition

When disposing Products please dispose them properly using an authorized industry waste company.

### Precaution for Foreign Exchange and Foreign Trade act

Since concerned goods might be fallen under listed items of export control prescribed by Foreign exchange and Foreign trade act, please consult with ROHM in case of export.

### Precaution Regarding Intellectual Property Rights

1. All information and data including but not limited to application example contained in this document is for reference only. ROHM does not warrant that foregoing information or data will not infringe any intellectual property rights or any other rights of any third party regarding such information or data.
2. ROHM shall not have any obligations where the claims, actions or demands arising from the combination of the Products with other articles such as components, circuits, systems or external equipment (including software).
3. No license, expressly or implied, is granted hereby under any intellectual property rights or other rights of ROHM or any third parties with respect to the Products or the information contained in this document. Provided, however, that ROHM will not assert its intellectual property rights or other rights against you or your customers to the extent necessary to manufacture or sell products containing the Products, subject to the terms and conditions herein.

### Other Precaution

1. This document may not be reprinted or reproduced, in whole or in part, without prior written consent of ROHM.
2. The Products may not be disassembled, converted, modified, reproduced or otherwise changed without prior written consent of ROHM.
3. In no event shall you use in any way whatsoever the Products and the related technical information contained in the Products or this document for any military purposes, including but not limited to, the development of mass-destruction weapons.
4. The proper names of companies or products described in this document are trademarks or registered trademarks of ROHM, its affiliated companies or third parties.



**General Precaution**

1. Before you use our Products, you are requested to carefully read this document and fully understand its contents. ROHM shall not be in any way responsible or liable for failure, malfunction or accident arising from the use of any ROHM's Products against warning, caution or note contained in this document.
2. All information contained in this document is current as of the issuing date and subject to change without any prior notice. Before purchasing or using ROHM's Products, please confirm the latest information with a ROHM sales representative.
3. The information contained in this document is provided on an "as is" basis and ROHM does not warrant that all information contained in this document is accurate and/or error-free. ROHM shall not be in any way responsible or liable for any damages, expenses or losses incurred by you or third parties resulting from inaccuracy or errors of or concerning such information.