

Power Common Mode Chokes

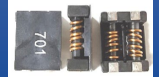

ACMP-1566 Series

Request Samples



Check Inventory



15.0 x 13.0 x 6.6 mm
RoHS/RoHS II Compliant
MSL Level = 1

Features

- Commercial Grade
- PPAP ready and supported
- Excellent impedance characteristics
- Rated current up to 13A
- Extremely Low DCR

Applications

- DC power line common mode noise suppression.
- Switch Mode Power Supplies and regulators
- Variable Frequency Drives
- AC/DC power rectifiers

Electrical Specifications

| Part Number | Impedance (Ω) @100MHz | | DCR (m Ω) | Rated Current (A) | Rated Voltage (Vdc) | Insulation Resistance (M Ω) |
|---------------|--------------------------------|------|-------------------|-------------------|---------------------|-------------------------------------|
| | Min | Typ. | Max | Typ. | Max | Min |
| ACMP-1566-301 | 225 | 300 | 5.0 | 13 | 80 | 10 |
| ACMP-1566-501 | 400 | 500 | 6.0 | 10 | 80 | 10 |
| ACMP-1566-551 | 400 | 550 | 6.0 | 10 | 80 | 10 |
| ACMP-1566-601 | 500 | 600 | 7.0 | 10 | 80 | 10 |
| ACMP-1566-701 | 500 | 700 | 7.0 | 10 | 80 | 10 |
| ACMP-1566-102 | 800 | 1000 | 10 | 9 | 80 | 10 |
| ACMP-1566-152 | 1200 | 1500 | 23 | 5 | 80 | 10 |

Rated Current is based on an Irms temperature rise of 40°C

Operating Temperature: -40°C to +125°C (Including self-heating)

Storage (in original packaging): <40°C, <70% RH

ACMP-1566 Series is RoHS Compliant and Pb free

Power Common Mode Chokes



ACMP-1566 Series

Request Samples



Check Inventory



15.0 x 13.0 x 6.6 mm
RoHS/RoHS II Compliant
MSL Level = 1

Electrical Specifications (Cont'd)

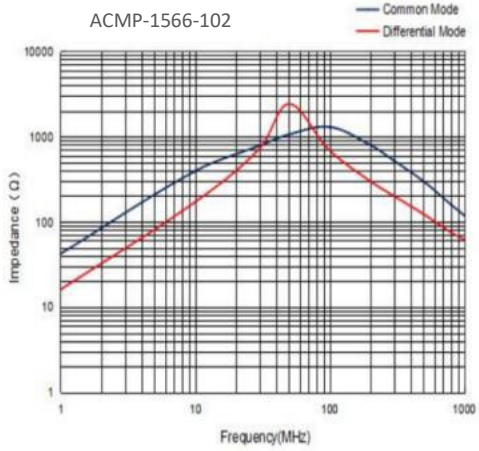
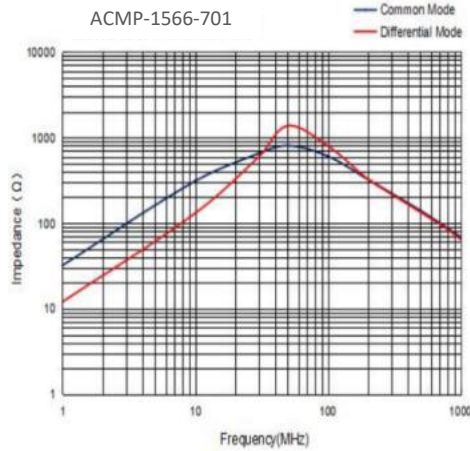
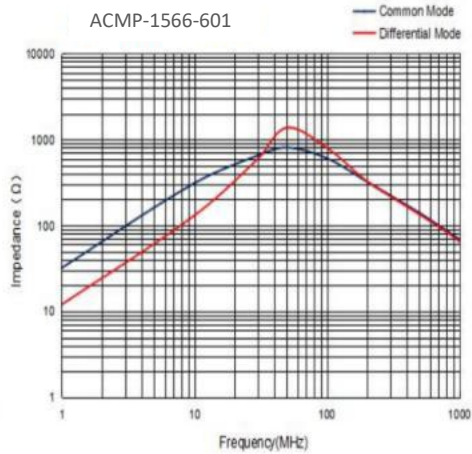
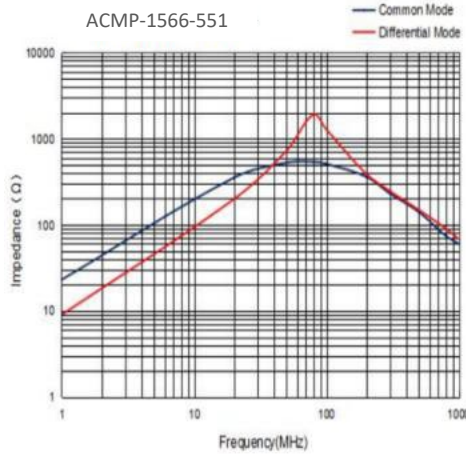
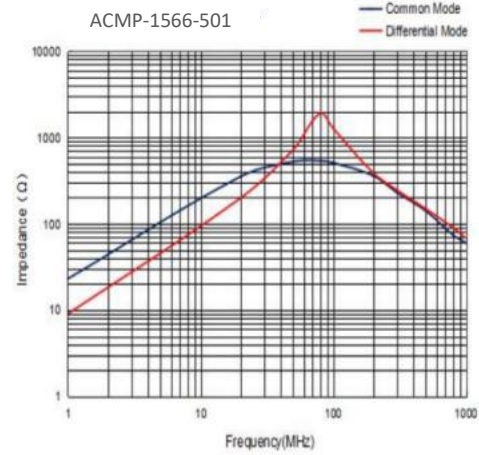
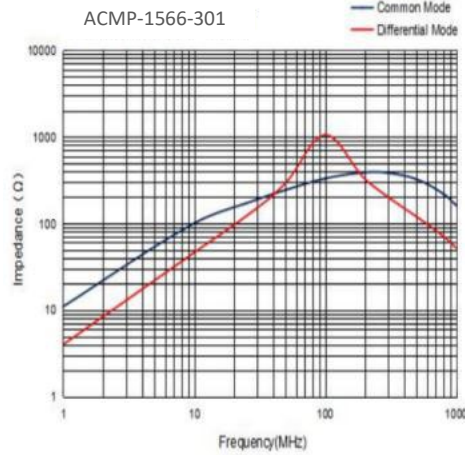

5101 Hidden Creek Ln Spicewood TX 78669
Phone: 512-371-6159 | Fax: 512-351-8858
For terms and conditions of sales, please visit:
www.abracon.com

REVISION: IR 06-29-22

ABRACON IS
ISO9001-2015
CERTIFIED

Power Common Mode Chokes



ACMP-1566 Series

Request Samples



Check Inventory



15.0 x 13.0 x 6.6 mm
RoHS/RoHS II Compliant
 MSL Level = 1

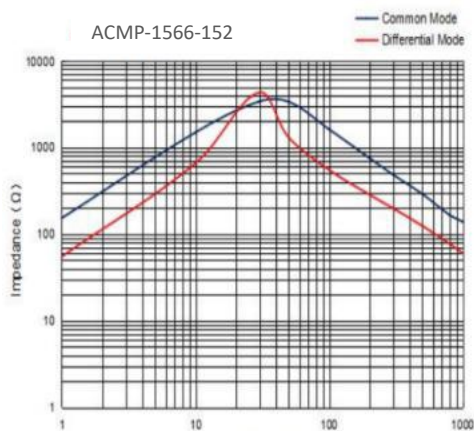

Mechanical Specifications

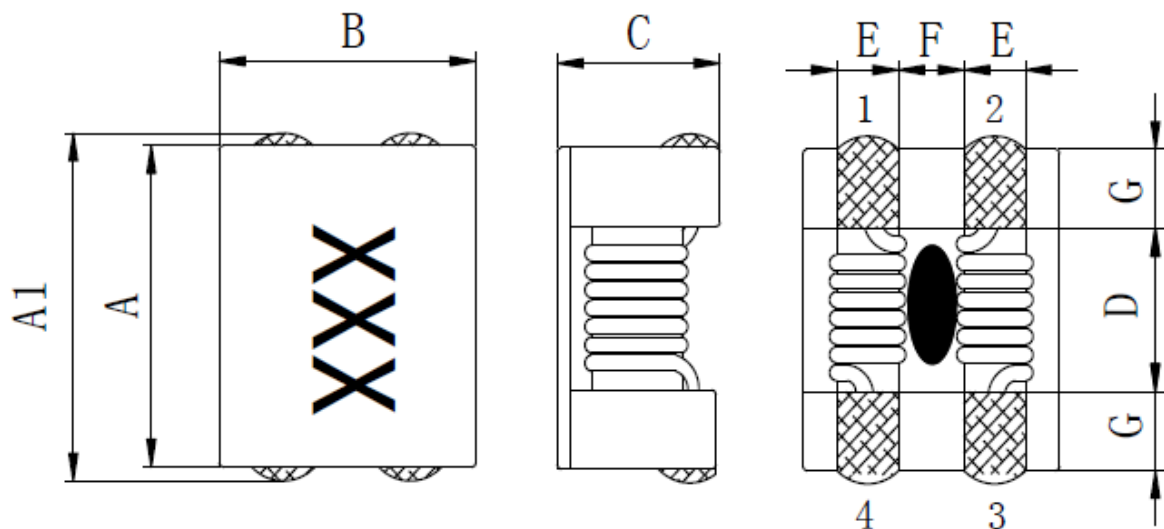

| A | A1 | B | C | D | E | G |
|------------|------------|----------|---------|----------|---------|----------|
| 15.0 ± 0.5 | 15.6 ± 0.5 | 13 ± 0.5 | 6.6 MAX | 9.4 Ref. | 2.6 Ref | 2.5 Ref. |

Dimensions: mm



5101 Hidden Creek Ln Spicewood TX 78669
 Phone: 512-371-6159 | Fax: 512-351-8858
 For terms and conditions of sales, please visit:
www.abracon.com

REVISION: IR 06-29-22

ABRACON IS
 ISO9001-2015
 CERTIFIED

Power Common Mode Chokes

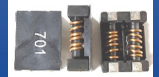

ACMP-1566 Series

Request Samples



Check Inventory



15.0 x 13.0 x 6.6 mm
RoHS/RoHS II Compliant
MSL Level = 1

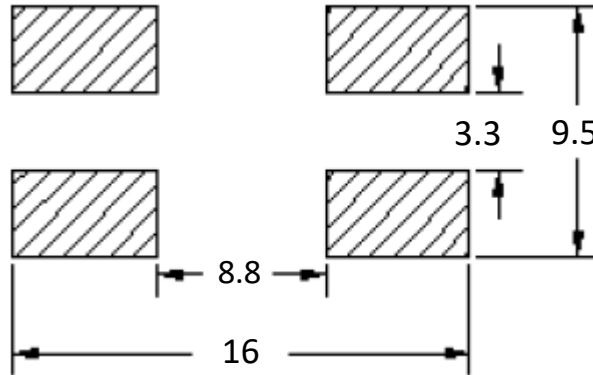

Recommended Layout

Dimensions: mm

Schematic

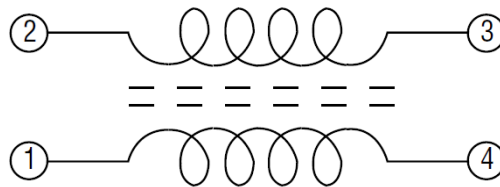

Materials

| Description | Specification |
|-------------|----------------------|
| Core | Ferrite core |
| Wire | Enameled copper wire |
| Base | LCP |
| Adhesive | Epoxy resin |
| Terminal | Sn/Cu |
| Ink | White |

Power Common Mode Chokes

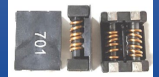

ACMP-1566 Series

Request Samples



Check Inventory



15.0 x 13.0 x 6.6 mm
RoHS/RoHS II Compliant
 MSL Level = 1

Part Identification

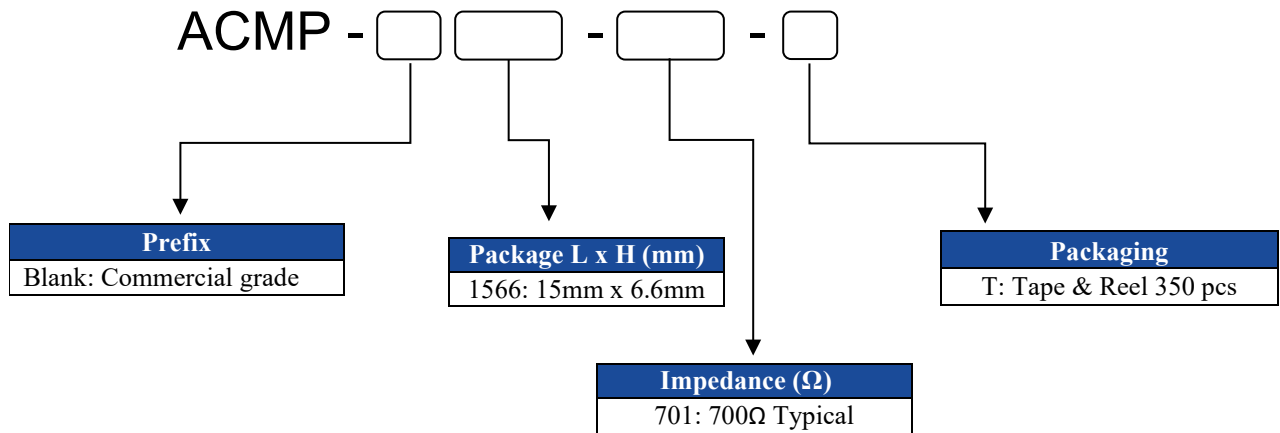

Reflow Profile

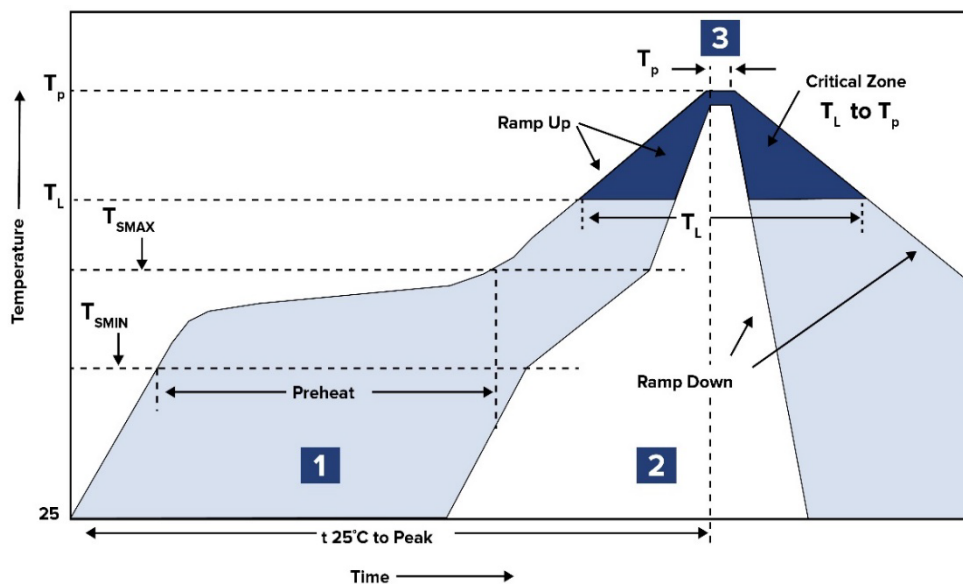

| Zone | Description | Temperature | Times |
|------|-------------|---|---------------|
| 1 | Preheat | $T_{SMIN} \sim T_{SMAX}$ 150°C ~ 190°C | 60 ~ 120 sec. |
| 2 | Reflow | T_L 240°C | 20 ~ 40 sec. |
| 3 | Peak heat | T_P 260°C Max. | 5 sec. Max |

1~2 °C/Sec. Ramp



5101 Hidden Creek Ln Spicewood TX 78669
 Phone: 512-371-6159 | Fax: 512-351-8858
 For terms and conditions of sales, please visit:
www.abracon.com

REVISION: IR 06-29-22

ABRACON IS
 ISO9001-2015
 CERTIFIED

Power Common Mode Chokes



ACMP-1566 Series

Request Samples



Check Inventory



15.0 x 13.0 x 6.6 mm
RoHS/RoHS II Compliant
MSL Level = 1

Packing

Tape & Reel: 350pcs/reel

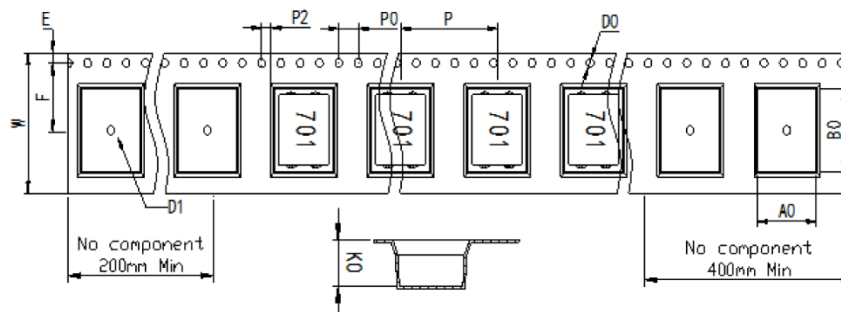
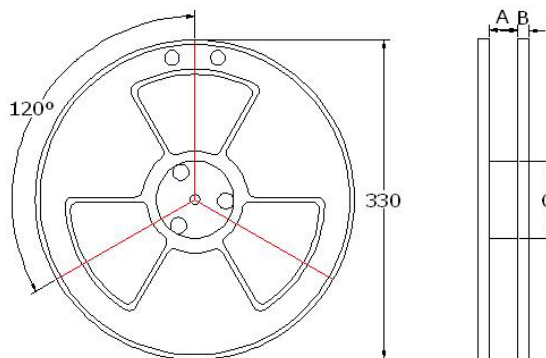

| W | P | P0 | P2 | D0 | E | F | A0 | B0 | K0 |
|--------------|--------------|---------------|---------------|---------------|----------------|----------------|--------------|----------------|---------------|
| 24 ± 0.30 | 20 ± 0.10 | 4.0 ± 0.10 | 2.0 ± 0.10 | 1.5 ± 0.10 | 1.75 ± 0.10 | 11.5 ± 0.10 | 14 ± 0.10 | 16.1 ± 0.10 | 6.6 ± 0.10 |

Dimensions: mm

ATTENTION: Abracon LLC's products are COTS – Commercial-Off-The-Shelf products; suitable for Commercial, Industrial and, where designated, Automotive Applications. Abracon's products are not specifically designed for Military, Aviation, Aerospace, Life-dependent Medical applications or any application requiring high reliability where component failure could result in loss of life and/or property. For applications requiring high reliability and/or presenting an extreme operating environment, written consent and authorization from Abracon LLC is required. Please contact Abracon LLC for more information.



5101 Hidden Creek Ln Spicewood TX 78669
 Phone: 512-371-6159 | Fax: 512-351-8858
 For terms and conditions of sales, please visit:
www.abracon.com

REVISION: IR 06-29-22

ABRACON IS
 ISO9001-2015
 CERTIFIED