

Low Dropout Voltage Regulator

■ GENERAL DESCRIPTION

The NJM2878 is a 150mA output low dropout voltage regulator with ON/OFF control.

Advanced bipolar technology achieves low noise, high ripple rejection, high accuracy and low quiescent current.

Small packaging (SC-88A/SC82AB) and very small packaging (ESON4), 0.47 μ F small decoupling capacitor and built-in noise bypass capacitor make the NJM2878 suitable for space conscious applications.

■ PACKAGE OUTLINE

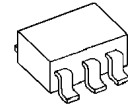

NJM2878F3

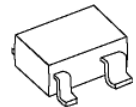

NJM2878F4

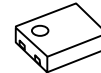

NJM2878KF1

■ FEATURES

- High Ripple Rejection 75dB typ. (f=1kHz Vo=3V version)
- Output Noise Voltage Vno=45 μ Vrms typ.
- Output capacitor with 0.47 μ F ceramic capacitor(Vo \geq 2.7V Version)
- Output Current Io(max.)=150mA
- High Precision Output Vo \pm 1.0%
- Low Dropout Voltage 0.10V typ. (Io=60mA)
- ON/OFF Control (Active High)
- Internal Thermal Overload Protection
- Internal Over Current Protection
- Bipolar Technology
- Package Outline SC88A(NJM2878F3) / SC82AB(NJM2878F4) / ESON4-F1(NJM2878KF1)

■ PIN CONFIGURATION

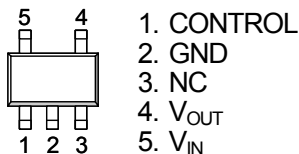

NJM2878F3

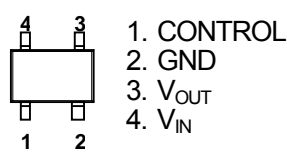

NJM2878F4

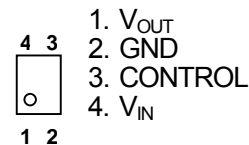

NJM2878KF1

■ EQUIVALENT CIRCUIT

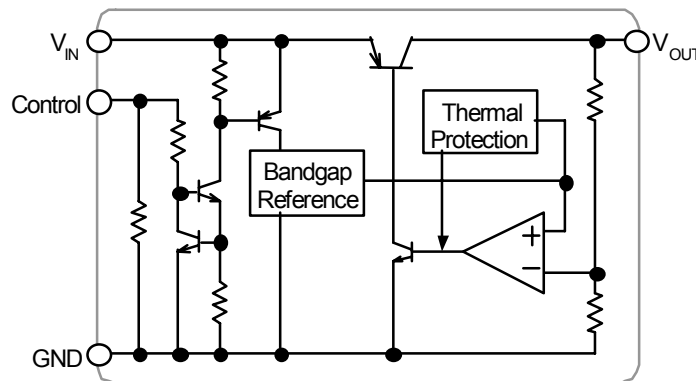

NJM2878

■ OUTPUT VOLTAGE RANK LIST

The WHITE column shows applicable Voltage Rank(s)

Device Name	V _{out}	Device Name	V _{out}
NJM2878F3/F4-15	1.5V	NJM2878F3/F4-35	3.5V
NJM2878F3/F4-16	1.6V	NJM2878F3/F4-36	3.6V
NJM2878F3/F4-17	1.7V	NJM2878F3/F4-37	3.7V
NJM2878F3/F4-18	1.8V	NJM2878F3/F4-38	3.8V
NJM2878F3/F4-19	1.9V	NJM2878F3/F4-39	3.9V
NJM2878F3/F4-02	2.0V	NJM2878F3/F4-04	4.0V
NJM2878F3/F4-21	2.1V	NJM2878F3/F4-41	4.1V
NJM2878F3/F4-22	2.2V	NJM2878F3-42	4.2V
NJM2878F3/F4-23	2.3V	NJM2878F3-43	4.3V
NJM2878F3/F4-24	2.4V	NJM2878F3/F4-44	4.4V
NJM2878F3/F4-25	2.5V	NJM2878F3/F4-45	4.5V
NJM2878F3/F4-26	2.6V	NJM2878F3/F4-46	4.6V
NJM2878F3/F4-27	2.7V	NJM2878F3/F4-47	4.7V
NJM2878F3/F4-28	2.8V	NJM2878F3/F4-48	4.8V
NJM2878F3/F4-29	2.9V	NJM2878F3/F4-49	4.9V
NJM2878F3/F4-03	3.0V	NJM2878F3/F4-05	5.0V
NJM2878F3/F4-31	3.1V		
NJM2878F3/F4-32	3.2V		
NJM2878F3/F4-33	3.3V		
NJM2878F3/F4-34	3.4V		

The WHITE column shows applicable Voltage Rank(s)

Device Name	V _{out}	Device Name	V _{out}
NJM2878KF1-15	1.5V	NJM2878KF1-35	3.5V
NJM2878KF1-16	1.6V	NJM2878KF1-36	3.6V
NJM2878KF1-17	1.7V	NJM2878KF1-37	3.7V
NJM2878KF1-18	1.8V	NJM2878KF1-38	3.8V
NJM2878KF1-19	1.9V	NJM2878KF1-39	3.9V
NJM2878KF1-02	2.0V	NJM2878KF1-04	4.0V
NJM2878KF1-21	2.1V	NJM2878KF1-41	4.1V
NJM2878KF1-22	2.2V	NJM2878KF1-42	4.2V
NJM2878KF1-23	2.3V	NJM2878KF1-43	4.3V
NJM2878KF1-24	2.4V	NJM2878KF1-44	4.4V
NJM2878KF1-25	2.5V	NJM2878KF1-45	4.5V
NJM2878KF1-26	2.6V	NJM2878KF1-46	4.6V
NJM2878KF1-27	2.7V	NJM2878KF1-47	4.7V
NJM2878KF1-28	2.8V	NJM2878KF1-48	4.8V
NJM2878KF1-29	2.9V	NJM2878KF1-49	4.9V
NJM2878KF1-03	3.0V	NJM2878KF1-05	5.0V
NJM2878KF1-31	3.1V		
NJM2878KF1-32	3.2V		
NJM2878KF1-33	3.3V		
NJM2878KF1-34	3.4V		

■ ABSOLUTE MAXIMUM RATINGS (Ta=25°C)

PARAMETER	SYMBOL	RATINGS	UNIT
Input Voltage	V_{IN}	+10	V
Control Voltage	V_{CONT}	+10	V
Power Dissipation	P_D	SC88A/SC82AB	250(*1)
		ESON4	150(*2)
			800(*3)
Operating Temperature	T_{opr}	-40 ~ +85	°C
Storage Temperature	T_{stg}	-40 ~ +125	°C

(*1): Mounted on glass epoxy board based on EIA/JEDEC. (114.3 × 76.2 × 1.6mm: 2Layers FR-4)

(*2): Mounted on glass epoxy board based on EIA/JEDEC STANDARD. (101.5×114.5×1.6mm: 2Layers FR-4)

(*3): Mounted on glass epoxy board based on EIA/JEDEC STANDARD. (101.5 × 114.5 × 1.6mm: 4Layers FR-4,
Internal foil area size: 99.5 × 99.5mm, Applying a thermal via hole to a board based on JEDEC standard JESD51-5)

■ Operating voltage

$V_{IN}=+2.3 \sim +9V$ (In case of $V_o < 2.1V$ version)

■ ELECTRICAL CHARACTERISTICS

($V_{IN}=V_o+1V$, $C_{IN}=0.1\mu F$, $C_o=0.47\mu F$: $V_o \geq 2.7V$ ($C_o=1.0\mu F$: $1.8V < V_o \leq 2.6V$, $C_o=2.2\mu F$: $V_o \leq 1.8V$), $T_a=25^\circ C$)

PARAMETER	SYMBOL	TEST CONDITION	MIN.	TYP.	MAX.	UNIT
Output Voltage	V_o	$I_o=30mA$	-1.0%	-	+1.0%	V
Quiescent Current	I_Q	$I_o=0mA$, except I_{cont}	-	140	195	μA
Quiescent Current at Control OFF	$I_{Q(OFF)}$	$V_{CONT}=0V$	-	-	100	nA
Output Current	I_o	$V_o - 0.3V$	150	200	-	mA
Line Regulation	$\Delta V_o / \Delta V_{IN}$	$V_{IN}=V_o+1V \sim V_o+6V (V_o \leq 3V)$, $V_{IN}=V_o+1V \sim 9V (V_o > 3V)$, $I_o=30mA$	-	-	0.10	%/V
Load Regulation	$\Delta V_o / \Delta I_o$	$I_o=0 \sim 100mA$	-	-	0.016	%/mA
Dropout Voltage (*4)	ΔV_{L-O}	$I_o=60mA$	-	0.10	0.18	V
Ripple Rejection	RR	$e_{in}=200mV_{rms}$, $f=1kHz$, $I_o=10mA$, $V_o=3V$ version	-	75	-	dB
Average Temperature Coefficient of Output Voltage	$\Delta V_o / \Delta T_a$	$T_a=0 \sim +85^\circ C$, $I_o=10mA$	-	± 50	-	ppm/°C
Output Noise Voltage	V_{NO1}	$f=10Hz \sim 80kHz$, $I_o=10mA$, $V_o=3V$ Version	-	45	-	μV_{rms}
Control Current	I_{CONT}	$V_{CONT}=1.6V$	-	3	12	μA
Control Voltage for ON-state	$V_{CONT(ON)}$		1.6	-	-	V
Control Voltage for OFF-state	$V_{CONT(OFF)}$		-	-	0.6	V
Input Voltage	V_{IN}		-	-	9	V

(*4): The output voltage excludes under 2.1V.

The above specification is a common specification for all output voltages.

Therefore, it may be different from the individual specification for a specific output voltage.

NJM2878

TEST CIRCUIT

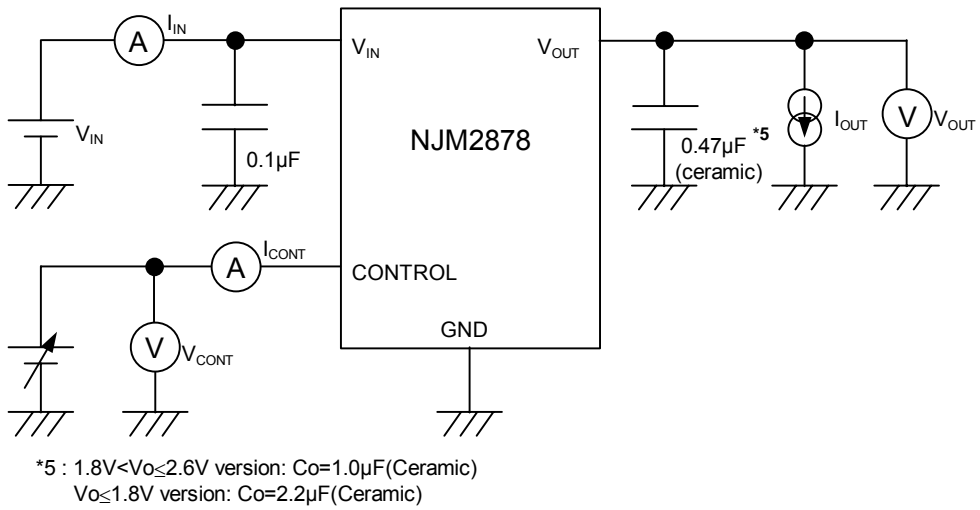

TYPICAL APPLICATION

① In the case where ON/OFF Control is not required:

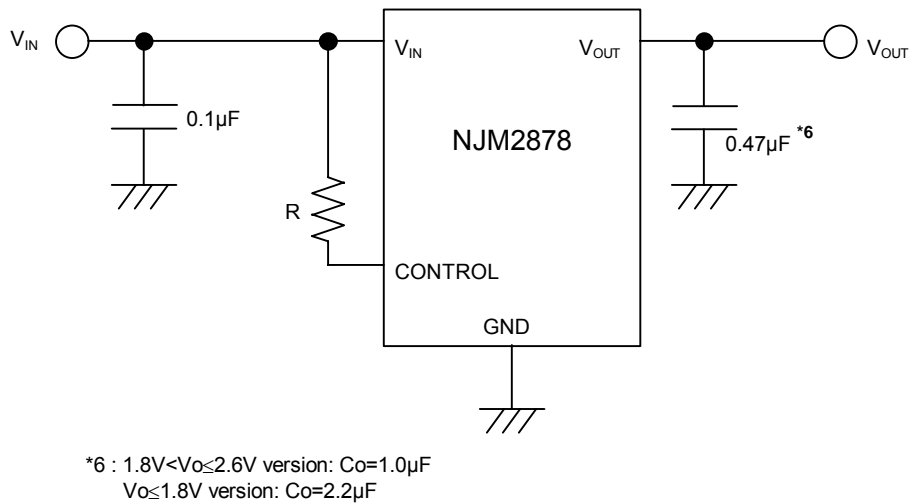

Connect control terminal to V_{IN} terminal

② In use of ON/OFF CONTROL:

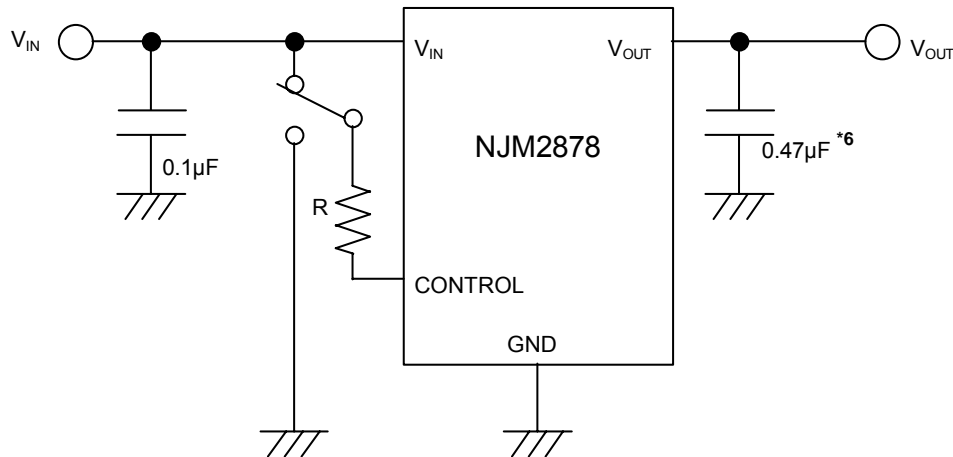

*6 : 1.8V < V_O ≤ 2.6V version: C_O = 1.0µF
 V_O ≤ 1.8V version: C_O = 2.2µF

State of control terminal:

- “H” → output is enabled.
- “L” or “open” → output is disabled.

*Input Capacitance C_{IN}

Input Capacitance C_{IN} is required to prevent oscillation and reduce power supply ripple for applications with high power supply impedance or a long power supply line.

You should use the C_{IN} value of 0.1µF larger to avoid the problem.

C_{IN} should connect between GND and V_{IN} as **shortest path** as possible.

*In the case of using a resistance "R" between V_{IN} and control.

The current flow into the control terminal while the IC is ON state (I_{CONT}) can be reduced when a pull up resistance "R" is inserted between V_{IN} and the control terminal.

The minimum control voltage for ON state ($V_{CONT(ON)}$) is increased due to the voltage drop caused by I_{CONT} and the resistance "R". The I_{CONT} is temperature dependence as shown in the "Control Current vs. Temperature" characteristics. Therefore, the resistance "R" should be carefully selected to ensure the control voltage exceeds the $V_{CONT(ON)}$ over the required temperature range.

*Output Capacitance C_O

Output capacitor (C_O) **will be** required for a phase compensation of the internal error amplifier.

The capacitance and the equivalent series resistance (ESR) influence to **stable operation** of the regulator.

This product is designed to work with a low ESR capacitor (C_O). However use of recommended capacitance or larger value is effective for stable operation.

Use of a smaller C_O may cause excess output noise or oscillation of the regulator due to lack of the phase compensation.

Therefore use C_O with the recommended capacitance or **larger** value and connect between V_O terminal and GND terminal with shortest path. The recommended capacitance depends on the output voltage rank. Low voltage regulator requires **larger** value C_O . Thus, check the recommended capacitance for each output voltage rank.

Use of a larger C_O reduces output noise and ripple output, and also improves output transient response against rapid load change.

NJM2878

■ POWER DISSIPATION vs. AMBIENT TEMPERATURE (SC-88A/SC82AB)

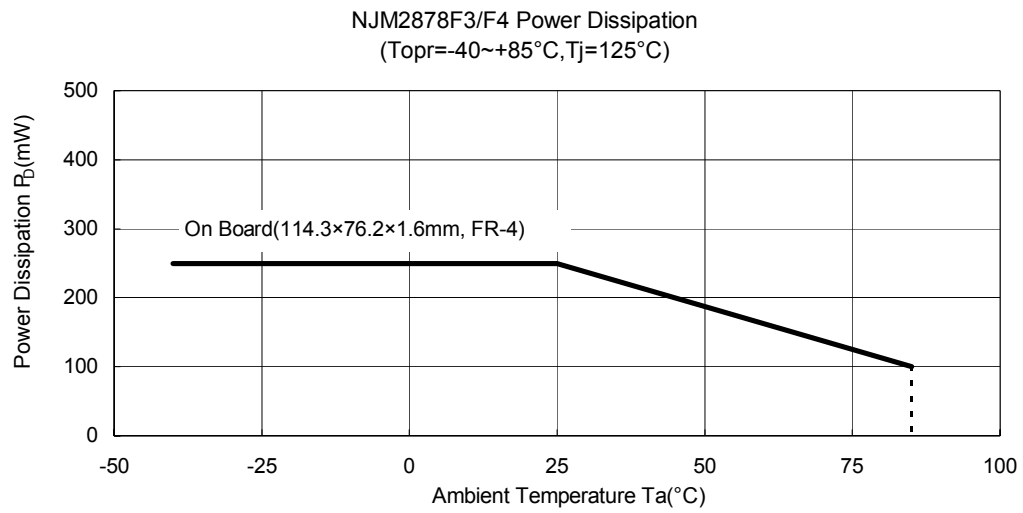

TYPICAL CHARACTERISTICS

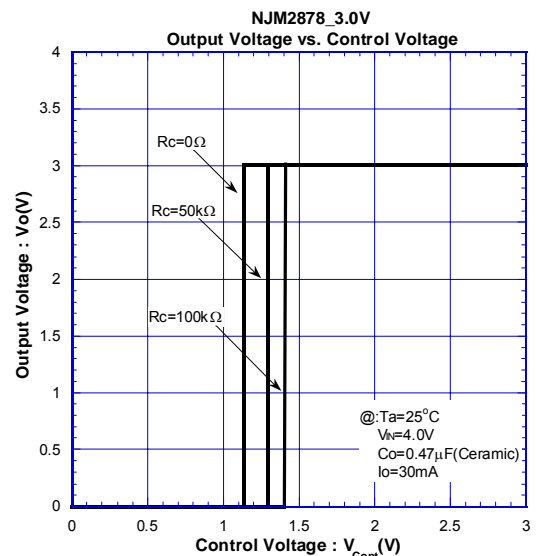
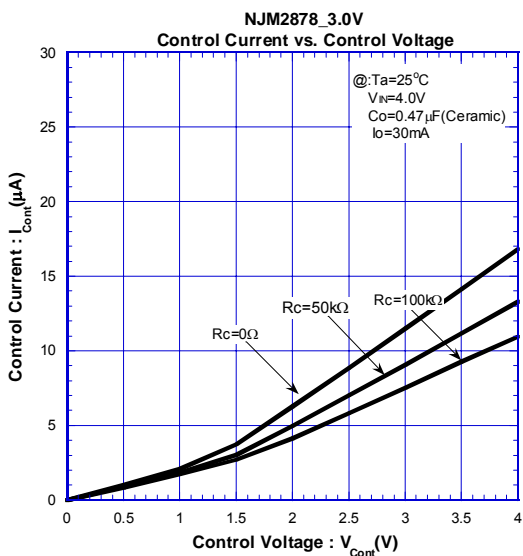
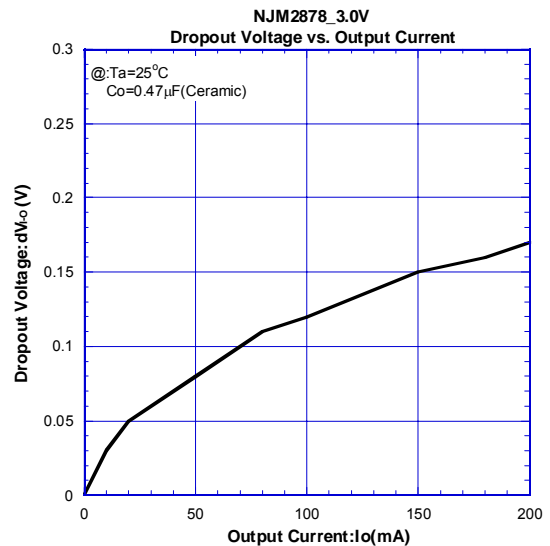
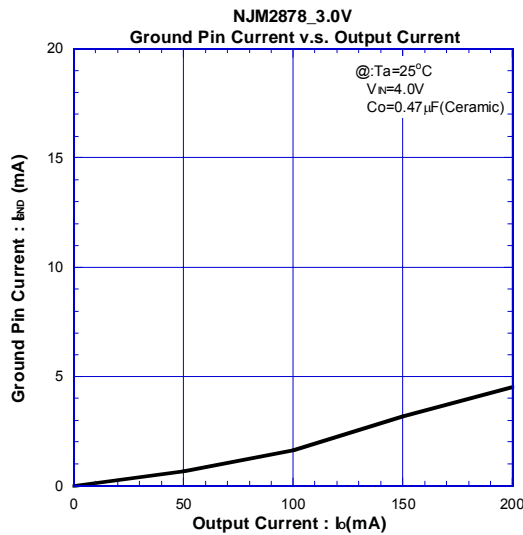
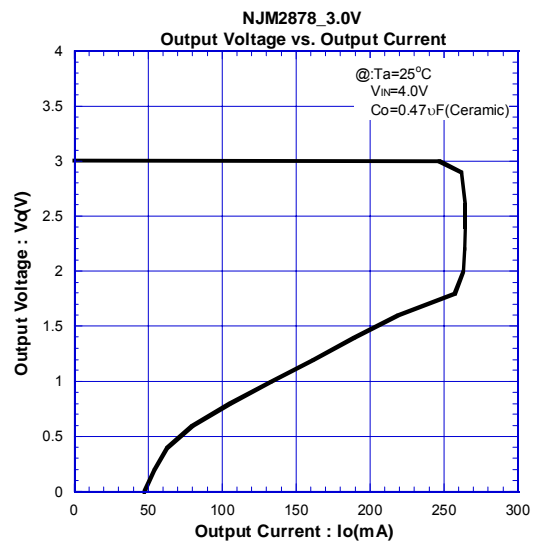
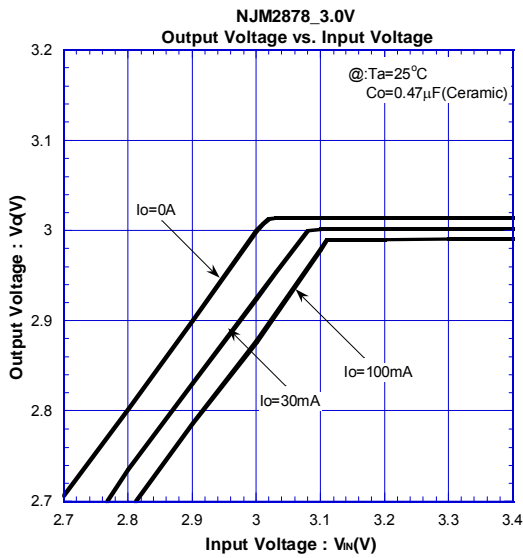

NJM2878

■ TYPICAL CHARACTERISTICS

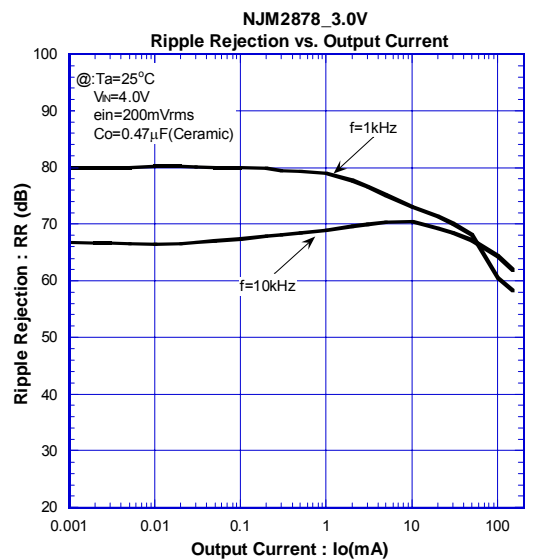
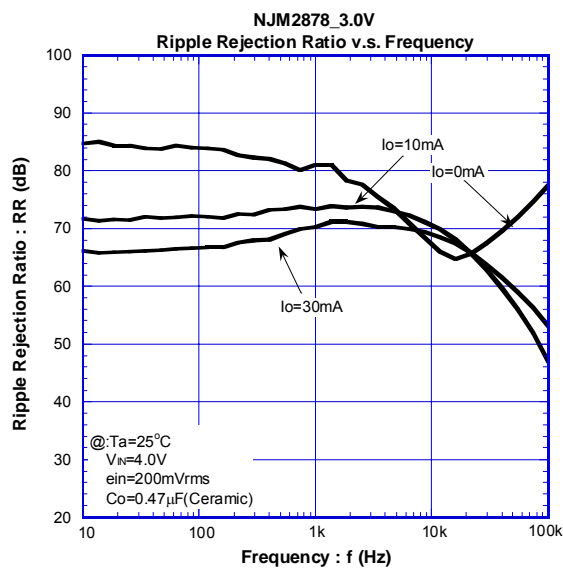
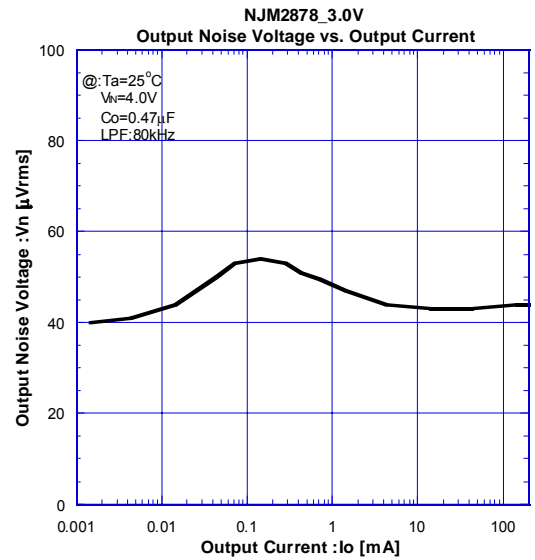
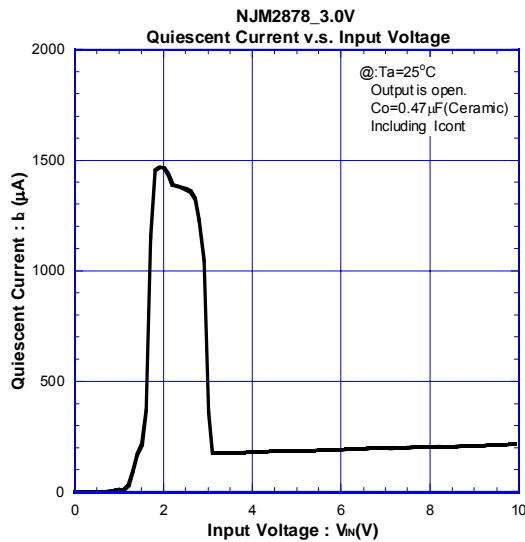
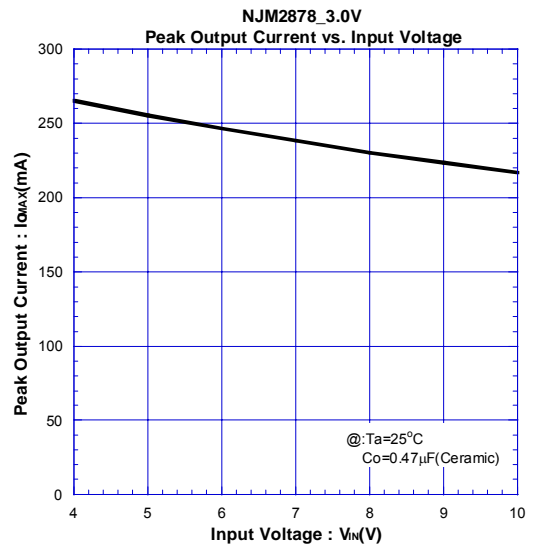
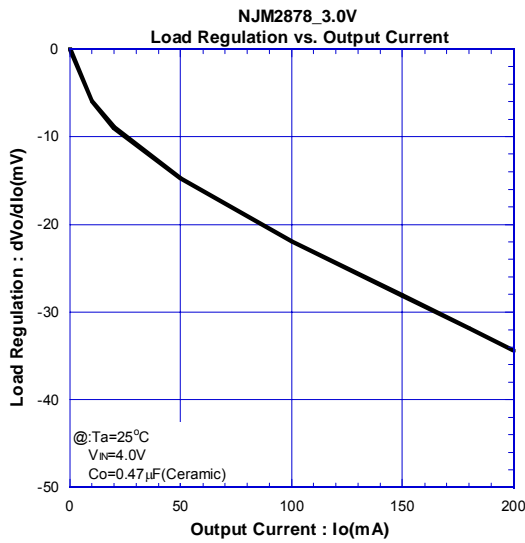

■ TYPICAL CHARACTERISTICS

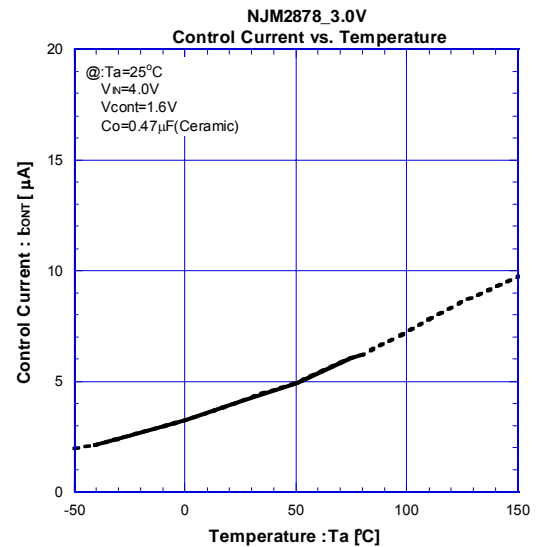
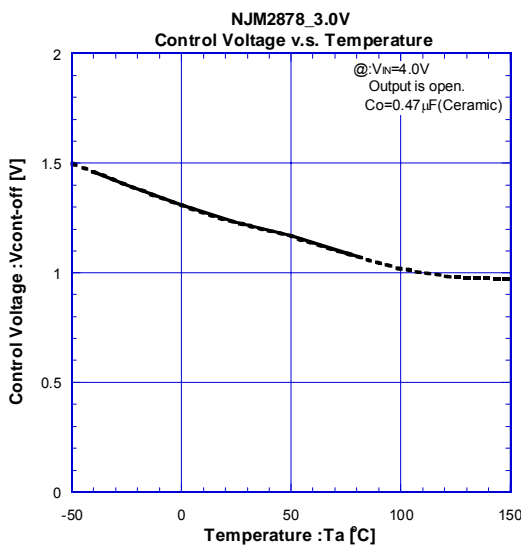
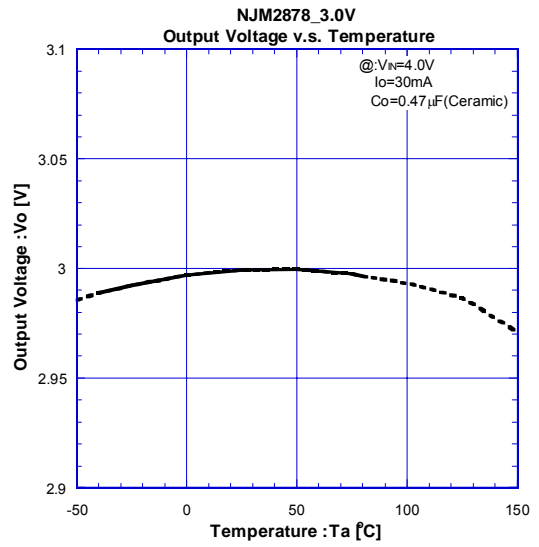
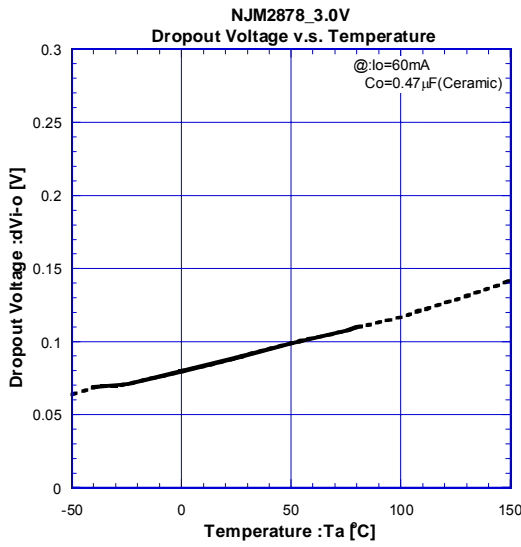
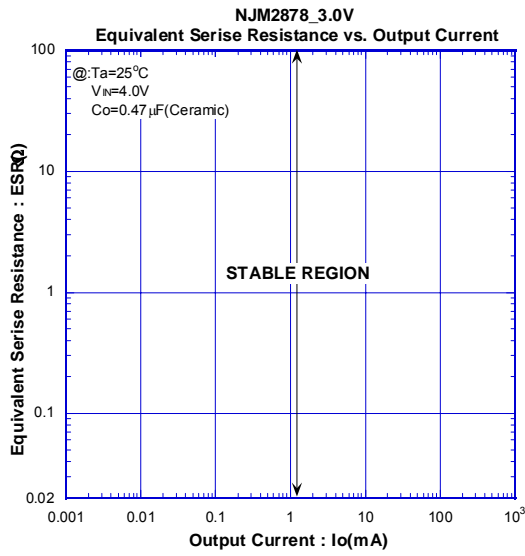

TYPICAL CHARACTERISTICS

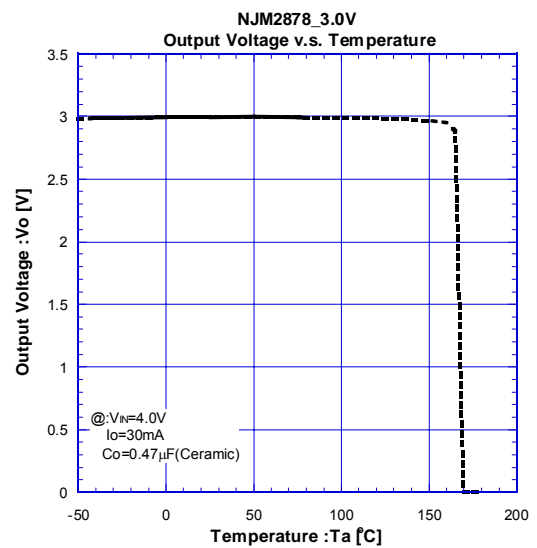
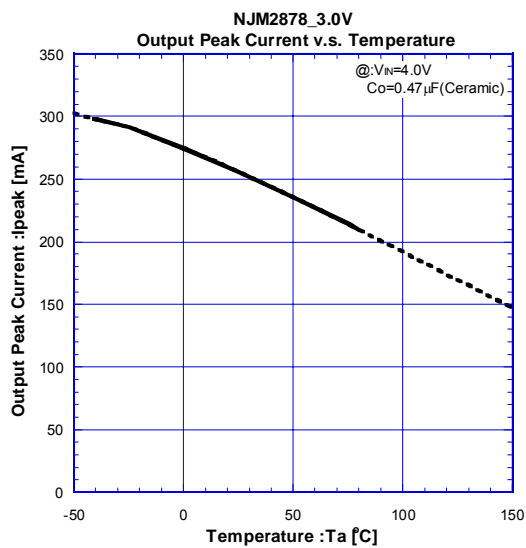
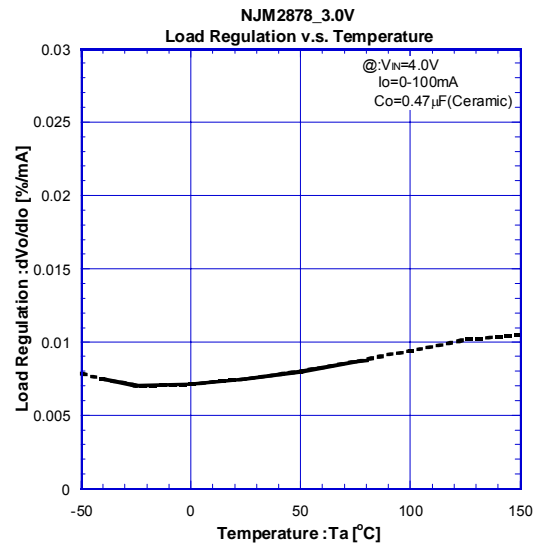
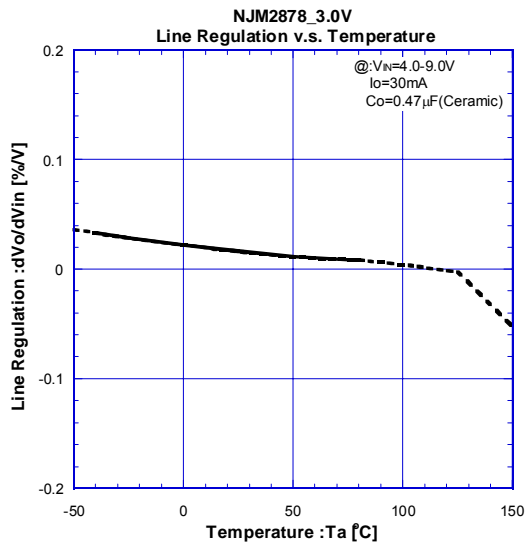
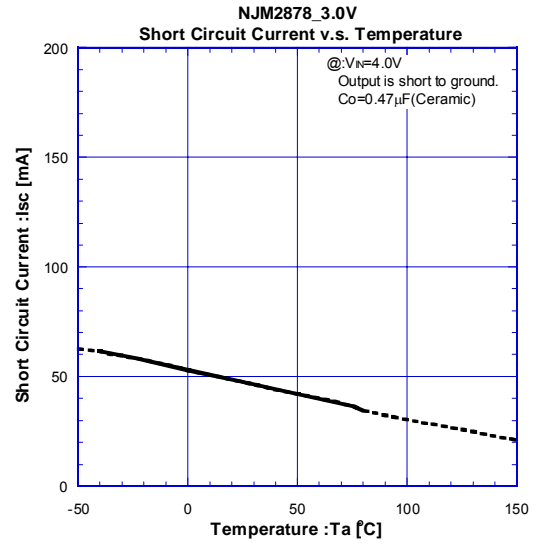
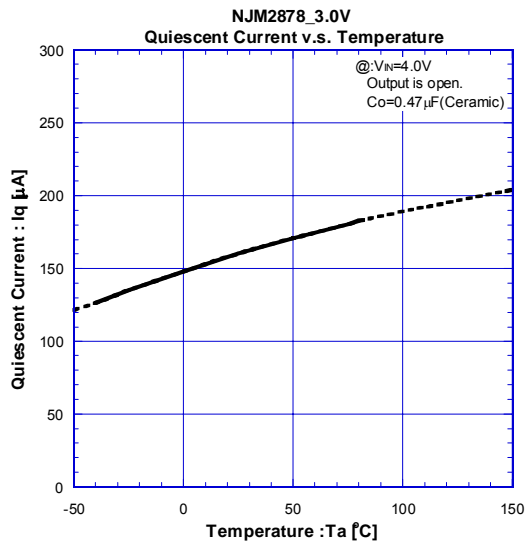

■ TYPICAL CHARACTERISTICS

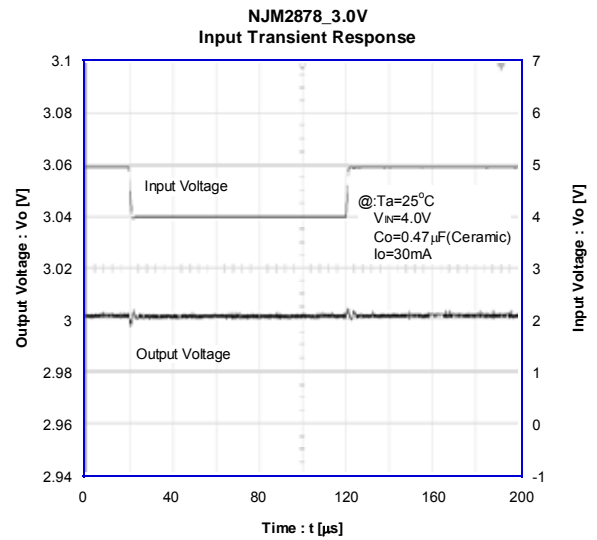
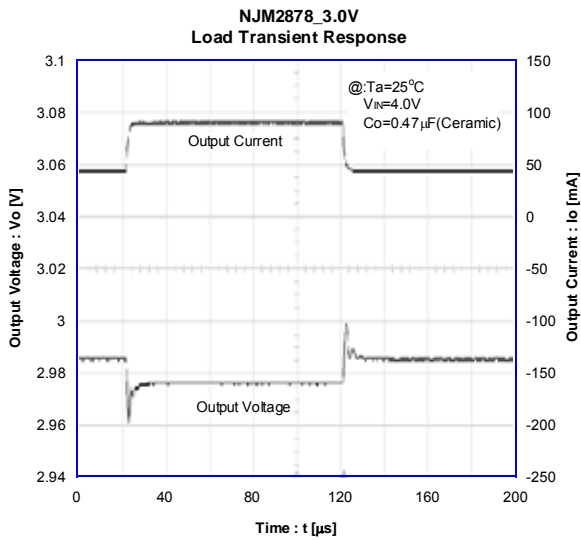
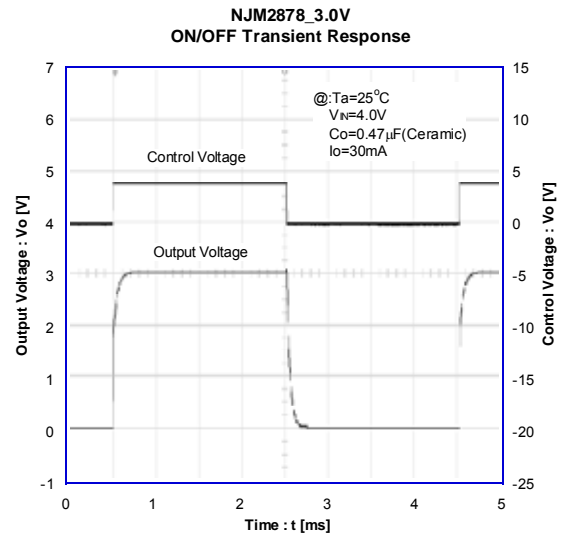
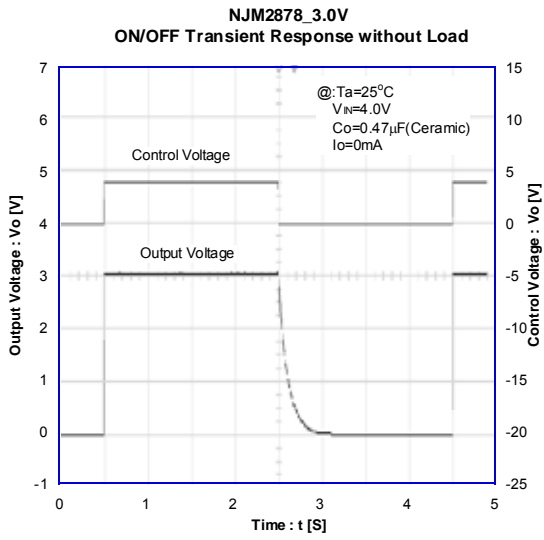

[CAUTION]
The specifications on this databook are only given for information, without any guarantee as regards either mistakes or omissions. The application circuits in this databook are described only to show representative usages of the product and not intended for the guarantee or permission of any right including the industrial rights.