

1000V High Voltage Monitor IC

■ FEATURES

- AEC-Q100 Grade 1 Qualified
- Operation Voltage Range 2.2V to 5.5V
- Common Mode Input Voltage Range 1000V
- Differential Input Voltage $\pm 1000V$
- High Precision Attenuation Rate
 $\pm 1\%$ ($T_a = -40^\circ C$ to $125^\circ C$)
- High Input Resistance 30M Ω min.
- Integrated EMI filter
- Operating Temperature $-40^\circ C$ to $125^\circ C$
- Package PMAP11-PM
New Package for Creepage Distance (IEC/EN60664)

■ GENERAL DESCRIPTION

The NJU7890 is a high voltage monitor IC capable of inputting voltages up to 1000V. With our proprietary semiconductor process technology, NJU7890 realizes wide common mode / differential input voltage.

The NJU7890 is suitable for powertrain application such as HV and EV.

■ APPLICATION

- Automotive application
Powertrain and Battery management ECU
- High-Voltage Monitoring Applications

■ BLOCK DIAGRAM

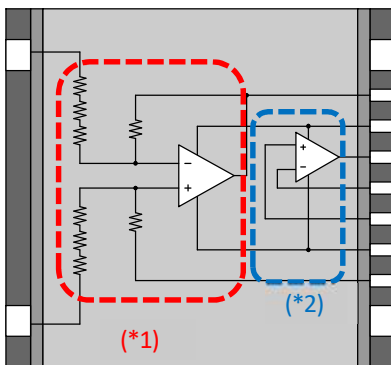

(*1) High Voltage Monitor Block

(*2) OP-Amp Block

■ ATTENUATION RATE VERSION

PRODUCT NAME	INPUT RESISTANCE	ATTENUATION VERSION	GAIN	PACKAGE
NJU7890YPM-A-Z	30MΩ	A	1/205	PMAP11-PM
NJU7890YPM-B-Z	30MΩ	B	1/311	PMAP11-PM

■ PIN CONFIGURATION

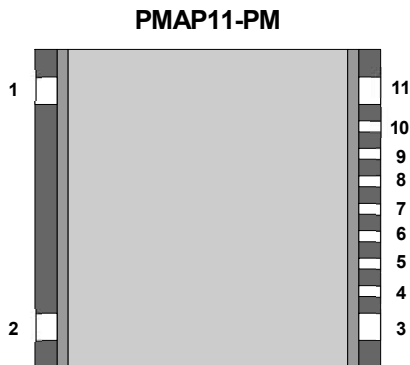

PIN NO.	SYMBOL
1	-HVIN
2	+HVIN
3	V ⁻
4	REF
5	V ⁻
6	+OPIN
7	-OPIN
8	OP OUT
9	V ⁺
10	OUT
11	V ⁻

■ PRODUCT NAME INFORMATION

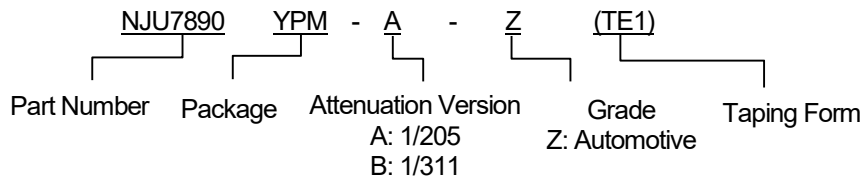

■ ORDERING INFORMATION

PRODUCT NAME	PACKAGE	RoHS	HALOGEN-FREE	TERMINAL FINISH	MARKING	WEIGHT (mg)	MOQ (pcs)
NJU7890YPM-A-Z (TE1)	PMAP11-PM	Yes	Yes	Sn2Bi	90AZ	300	2000
NJU7890YPM-B-Z (TE1)	PMAP11-PM	Yes	Yes	Sn2Bi	90BZ	300	2000

■ **ABSOLUTE MAXIMUM RATINGS** (REF = 0V, unless otherwise noted.)

PARAMETER	SYMBOL	RATINGS	UNIT
GENERAL CHARACTERISTICS			
Supply Voltage	$V^+ - V^-$	7	V
Power Dissipation ($T_a = 25^\circ\text{C}$) PMAP11-PM	P_D	2Layers / 4Layers 1100 ⁽¹⁾ / 2000 ⁽²⁾	mW
Junction Temperature	T_j	150	$^\circ\text{C}$
Storage Temperature	T_{stg}	-55 to 150	$^\circ\text{C}$
HIGH VOLTAGE MONITOR			
Input Voltage 1	V_{IN1}	-1000 to 1000	V
Differential Input Voltage 1	V_{ID1}	± 1000 ⁽³⁾	V
Reference Voltage	REF	$V^- - 0.3$ to V^+	V
OPERATIONAL AMPLIFIER			
Input Voltage 2	V_{IN2}	$V^- - 0.3$ to V^+	V
Differential Input Voltage 2	V_{ID2}	± 7	V

(1) 2-Layer: Mounted on glass epoxy board (76.2 mm × 114.3 mm × 1.6 mm: based on EIA/JEDEC standard, 2-layer FR-4).

(2) 4-Layer: Mounted on glass epoxy board (76.2 mm × 114.3 mm × 1.6 mm: based on EIA/JEDEC standard, 4-layer FR-4), internal Cu area: 74.2 mm × 74.2 mm.

(3) Differential voltage is the voltage difference between +HVIN and -HVIN

■ **RECOMMENDED OPERATING CONDITIONS**

PARAMETER	SYMBOL	RATINGS	UNIT
Supply Voltage	$V^+ - V^-$	2.2 to 5.5	V
Reference Voltage	REF	V^- to $V^+ - 0.85$	V
Operating Temperature	T_{opr}	-40 to 125	$^\circ\text{C}$

■ **POWER DISSIPATION vs. AMBIENT TEMPERATURE**

PMP11-PM Power Dissipation vs. Temperature

$T_{opr} = -40^\circ\text{C}$ to 125°C , $T_j = 150^\circ\text{C}$

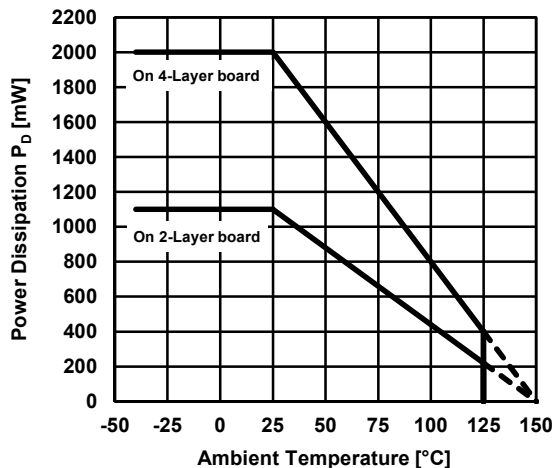

■ ELECTRICAL CHARACTERISTICS

PARAMETER	SYMBOL	TEST CONDITIONS	MIN	TYP	MAX	UNIT	
GENERAL CHARACTERISTICS ($V^+ = 5V$, $V^- = 0V$, $T_a = 25^\circ C$, unless otherwise noted.)							
Supply Current	I_{SUPPLY}	No signal	-	1.2	1.8	mA	
		No signal, $T_a = -40^\circ C$ to $125^\circ C$	-	-	1.8		
HIGH VOLTAGE MONITOR ($V^+ = 5V$, $V^- = 0V$, $REF = 2.5V$, $T_a = 25^\circ C$, unless otherwise noted.)							
Input Resistance	R_{IN}	-HVIN to OUT, $T_a = -40^\circ C$ to $125^\circ C$	30	-	42	$M\Omega$	
		+HVIN to REF, $T_a = -40^\circ C$ to $125^\circ C$	30	-	42		
Attenuation Rate	ATT	Aver		-0.7%	1/205	+0.7%	V/V
			$T_a = -40^\circ C$ to $125^\circ C$	-1.0%	-	+1.0%	
		Bver		-0.7%	1/311	+0.7%	
			$T_a = -40^\circ C$ to $125^\circ C$	-1.0%	-	+1.0%	
Output Offset Voltage	V_{OS-RTO}	-/+HVIN = 0V	-	0.04	0.30	mV	
		-/+HVIN = 0V, $T_a = -40^\circ C$ to $125^\circ C$	-	-	0.80		
Supply Voltage Rejection Ratio 1	SVR1	$V^+ = 2.2V$ to $5.5V$, Referred to output	70	80	-	dB	
Common Mode Rejection Ratio1	CMR1	Aver	$V_{ICM} = -/+HVIN = 0V$ to $660V$, Referred to output, $V^+ = 5V$, $V^- = 0V$, $REF = 0.5V$	85	100	-	dB
		Bver	$V_{ICM} = -/+HVIN = 0V$ to $1000V$, Referred to output, $V^+ = 5V$, $V^- = 0V$, $REF = 0.5V$	85	100	-	
High-level Output Voltage 1	V_{OH1}	$R_L = 10k\Omega$ to $2.5V$	$V^+ - 0.20$	$V^+ - 0.05$	-	V	
Low-level Output Voltage 1	V_{OL1}	$R_L = 10k\Omega$ to $2.5V$	-	$V^+ - 0.05$	$V^+ + 0.20$	V	

■ Calculation of output voltage

$$V_{OUT} = (V_{+HVIN} - V_{-HVIN}) \times ATT + V_{REF} + V_{OS-RTO} + \frac{|5V - V^+|}{SVR1} + \frac{|V_{+HVIN}|}{CMR1}$$

Calculation example

$V_{+HVIN} = -100V, V_{-HVIN} = 200V, V_{REF} = 4V, V^+ = 5.2V, ATT = 1/205 \pm 0.7\% (T_a = 25^\circ C), V_{OS-RTO} = 0.3mV, SVR1 = 70dB, CMR1 = 85dB$

$$V_{OUT} = (-100V - 200V) \times \left(\frac{1}{205} \pm 0.7\% \right) + 4V + 0.3mV + \frac{|-0.2V|}{70dB} + \frac{|-100V|}{85dB}$$

$$V_{OUT} = -300V \times \left(\frac{1}{205} \pm 0.7\% \right) + 4V + 0.3mV + 0.06mV + 5.6mV = 2.553V$$

Without the error component of the calculation example above, the output voltage is 2.537V. The error 0.016V obtained from the calculation example is $0.016V \times (1 \div ATT) = 3.280V$ by calculating the input conversion. The error rate obtained from the input conversion value can be calculated as 1.09% from $3.280V \div 300V$. In addition to the above formula, please be aware that there is a VREF error (accuracy influence).

Evaluation circuit example

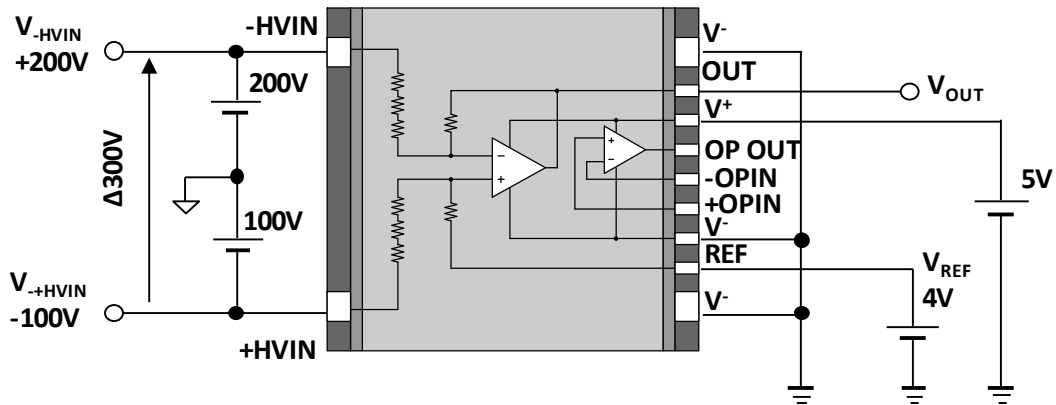

■ +HVIN input Voltage Range

In order for this IC to operate normally, the positive input terminal voltage (V_{+IN}) of operational amplifier A must be within the common mode input voltage range of operational amplifier A.

Operational amplifier A: common mode input voltage range

$$V^- \leq V_{+IN} \leq V^+ - 0.85V$$

Therefore, it is necessary to satisfy the following formula expressed by V^+/V^- (supply voltage), V_{+HVIN} (+HVIN terminal voltage), V_{REF} (REF terminal voltage), ATT (attenuation rate).

Calculation

$$V^- \leq \frac{1}{1 + ATT^{-1}} \times V_{+HVIN} + \frac{1}{1 + ATT} \times V_{REF} \leq V^+ - 0.85V$$

Calculation example

$$V_{REF} = 4V, V^+ / V^- = 5V / 0V, ATT = 1/205$$

$$0V \leq \frac{1}{1 + 205} \times V_{+HVIN} + \frac{1}{1 + 1/205} \times 4V \leq 5V - 0.85V$$

$$-820V \leq V_{+HVIN} \leq 34.9V$$

Characteristics example

The figure below shows an example of characteristics when the attenuation rate is set to 1/205 (Aver) and 1/311 (Bver). The range indicated by the graph is the input voltage range of the +HVIN.

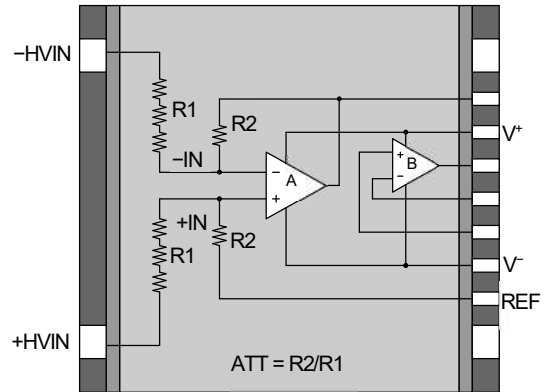

+HVIN Input Voltage Range vs REF Voltage
 $V^+/V^- = 5V/0V, V_{REF} = 0 \text{ to } 4.15V$

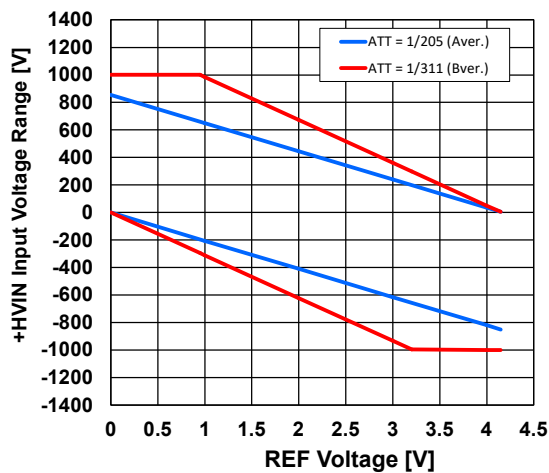

■ ELECTRICAL CHARACTERISTICS

PARAMETER	SYMBOL	TEST CONDITIONS	MIN	TYP	MAX	UNIT
OPERATIONAL AMPLIFIER ($V^+ = 5V$, $V^- = 0V$, $T_a = 25^\circ C$, unless otherwise noted.)						
Input Offset Voltage	V_{IO}		-	0.04	0.30	mV
		$T_a = -40^\circ C$ to $125^\circ C$	-	-	0.80	
Input Offset Voltage Drift	$\Delta V_{IO}/\Delta T$	$T_a = -40^\circ C$ to $125^\circ C$	-	0.5	-	$\mu V/^\circ C$
Input Bias Current	I_B	-/+OPIN	-	1	-	pA
Input Offset Current	I_{IO}	-/+OPIN	-	1	-	pA
Open-Loop Voltage Gain	A_v	$R_L \geq 10k\Omega$ to 2.5V, OP OUT = 2.5V $\pm 2V$	100	130	-	dB
		$R_L \geq 10k\Omega$ to 2.5V, OP OUT = 2.5V $\pm 2V$, $T_a = -40^\circ C$ to $125^\circ C$	100	-	-	
High-level Output Voltage 2	V_{OH2}	$R_L = 10k\Omega$ to 2.5V	4.95	4.98	-	V
		$R_L = 10k\Omega$ to 2.5V, $T_a = -40^\circ C$ to $125^\circ C$	4.95	-	-	
Low-level Output Voltage 2	V_{OL2}	$R_L = 10k\Omega$ to 2.5V	-	0.02	0.05	V
		$R_L = 10k\Omega$ to 2.5V, $T_a = -40^\circ C$ to $125^\circ C$	-	-	0.05	
High-level Output Voltage 3	V_{OH3}	$R_L = 600k\Omega$ to 2.5V	4.85	4.92	-	V
		$R_L = 600k\Omega$ to 2.5V, $T_a = -40^\circ C$ to $125^\circ C$	4.85	-	-	
Low-level Output Voltage 3	V_{OL3}	$R_L = 600\Omega$ to 2.5V	-	0.08	0.15	V
		$R_L = 600\Omega$ to 2.5V, $T_a = -40^\circ C$ to $125^\circ C$	-	-	0.20	
Output Current	I_{OUT}	$V_{OH} \geq 4.85V$, $V_{OL} \leq 0.15V$	2	3	-	mA
		$V_{OH} \geq 4.85V$, $V_{OL} \leq 0.15V$, $T_a = -40^\circ C$ to $125^\circ C$	2	-	-	
Common Mode Rejection Ratio 2	CMR2	$V_{ICM} = -/+OPIN = 0V$ to 4V	70	90	-	dB
		$V_{ICM} = -/+OPIN = 0V$ to 4V, $T_a = -40^\circ C$ to $125^\circ C$	70	-	-	
Common Mode Input Voltage Range	V_{ICM}	CMR $\geq 70dB$, -/+OPIN	0	-	4	V
		CMR $\geq 70dB$, -/+OPIN, $T_a = -40^\circ C$ to $125^\circ C$	0	-	4	
Supply Voltage Rejection Ratio 2	SVR2	$V^+ = 2.2V$ to 5.5V	70	90	-	dB
		$V^+ = 2.2V$ to 5.5V, $T_a = -40^\circ C$ to $125^\circ C$	70	-	-	
Gain Bandwidth Product	GBW	$G_V = 40dB$, $R_F = 100k\Omega$, $R_L = 10k\Omega$ to 2.5V, $C_L = 20pF$, $f = 100kHz$	-	1.3	-	MHz
Phase Margin	ϕ_M	$G_V = 40dB$, $R_F = 100k\Omega$, $R_L = 10k\Omega$ to 2.5V, $C_L = 20pF$	-	60	-	deg
Gain Margin	G_M	$G_V = 40dB$, $R_F = 100k\Omega$, $R_L = 10k\Omega$ to 2.5V, $C_L = 20pF$	-	12	-	dB
Slew Rate	SR	$G_V = 0dB$, $R_L = 10k\Omega$ to 2.5V, $C_L = 20pF$, $V_{IN} = 3V_{PP}$	-	0.5	-	V/ μs

■ TYPICAL CHARACTERISTICS (General Characteristics/High Voltage Monitor)

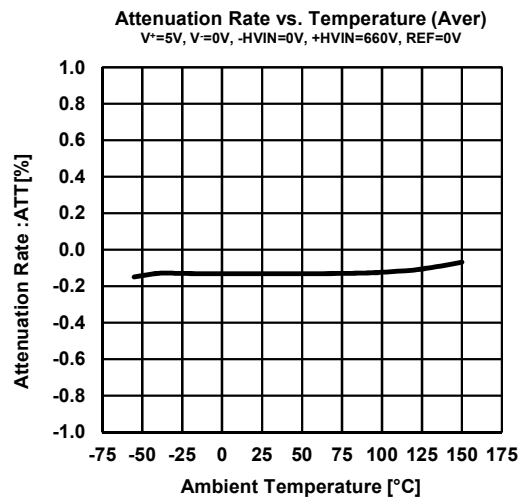
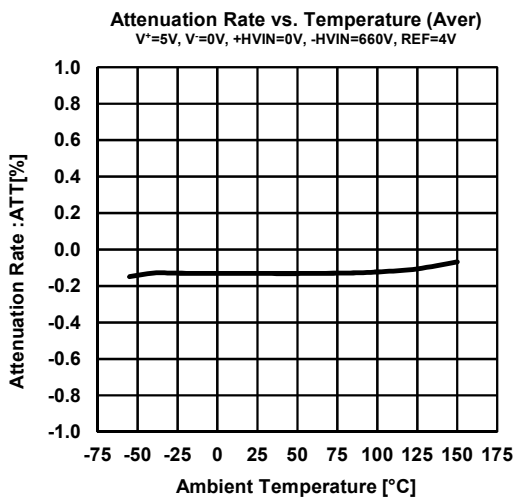
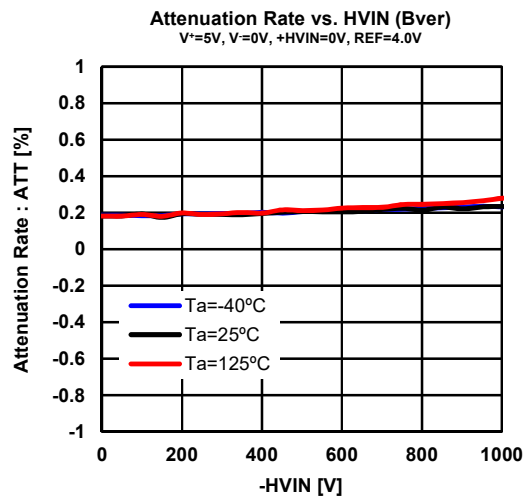
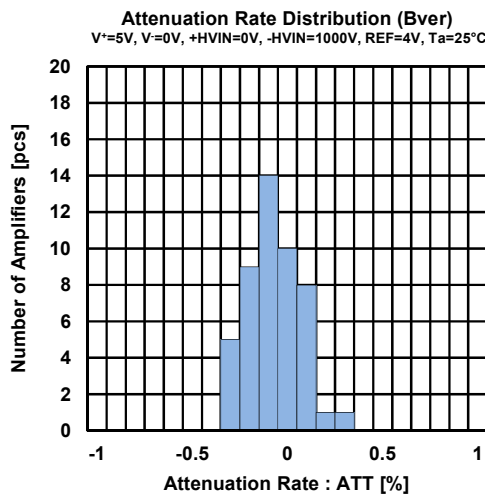
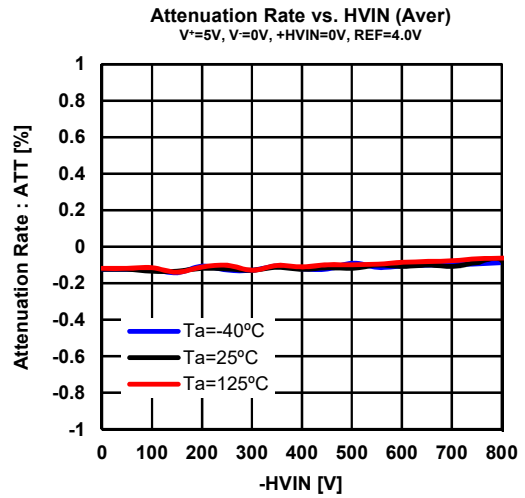
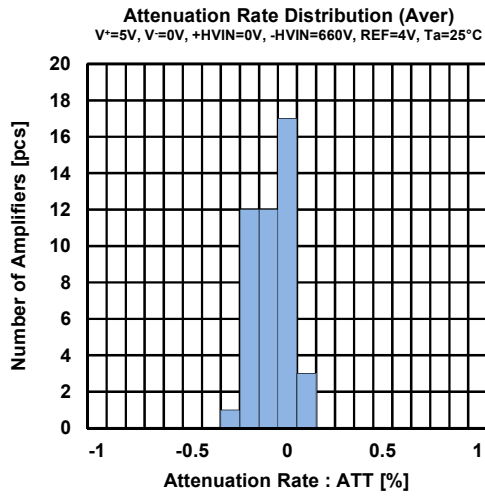

■ TYPICAL CHARACTERISTICS (General Characteristics /High Voltage Monitor)

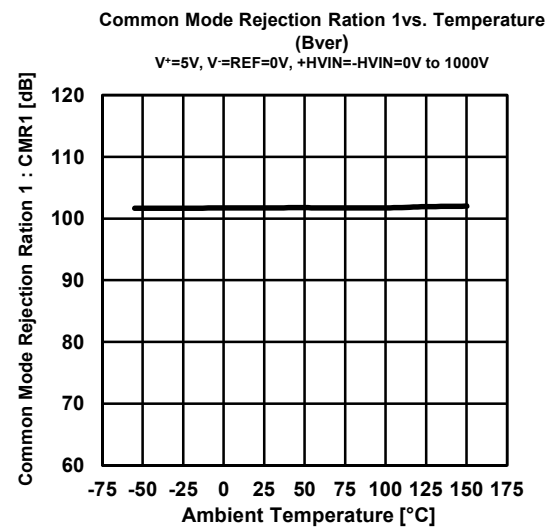
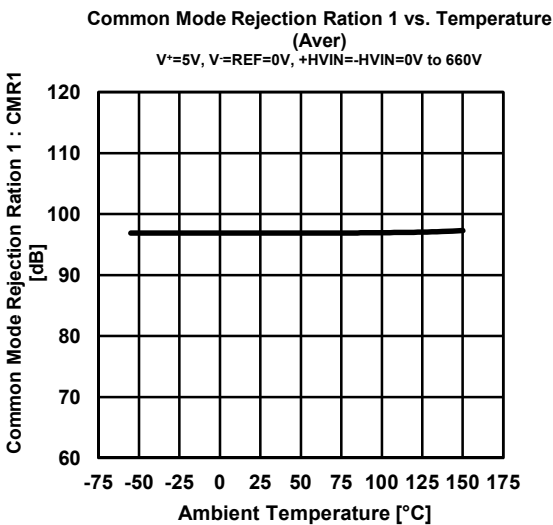
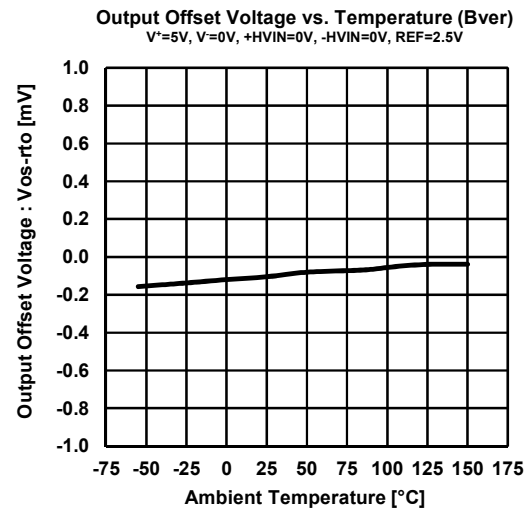
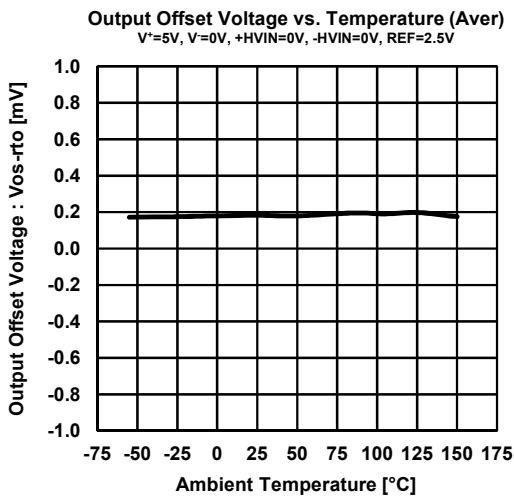
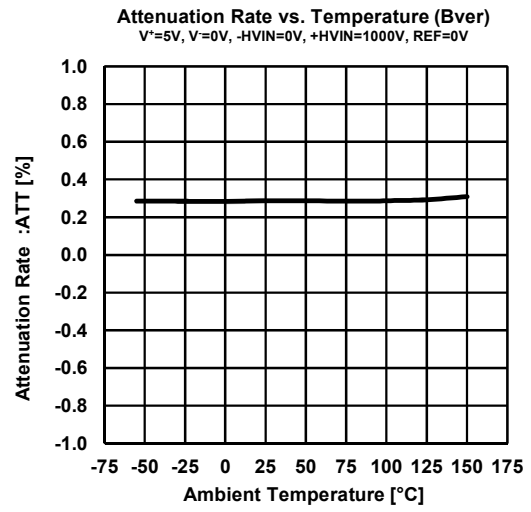
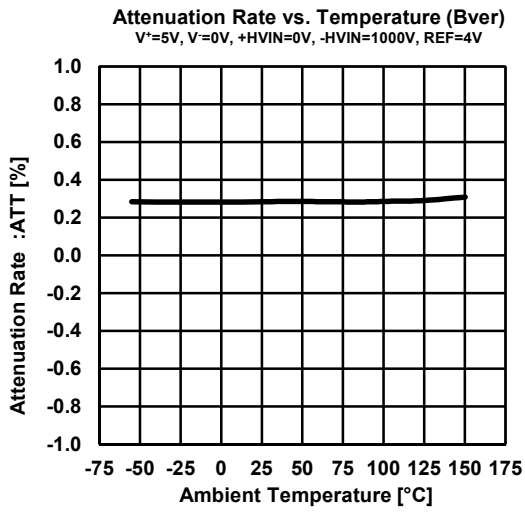

■ TYPICAL CHARACTERISTICS (General Characteristics/High Voltage Monitor)

Supply Voltage Rejection Ratio 1 vs. Temperature
(Common to each ver)

$V^+=2.2V$ to $5.5V$, $V=0V$, $+HVIN=-HVIN=0V$, $REF=V^+/2$

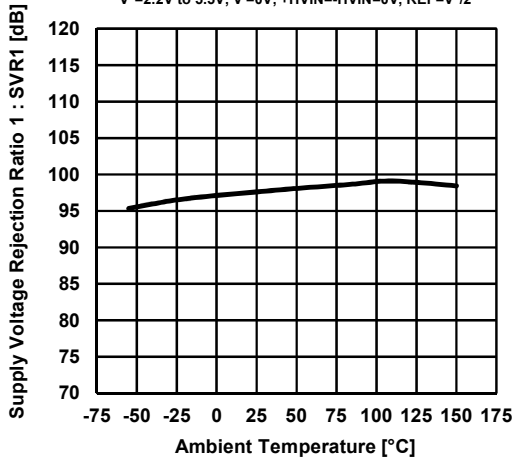

High-level Output Voltage 1 vs. Temperature
(Common to each ver)

$V^+=5V$, $V=0V$, $R_L=10k\Omega$ to $2.5V$

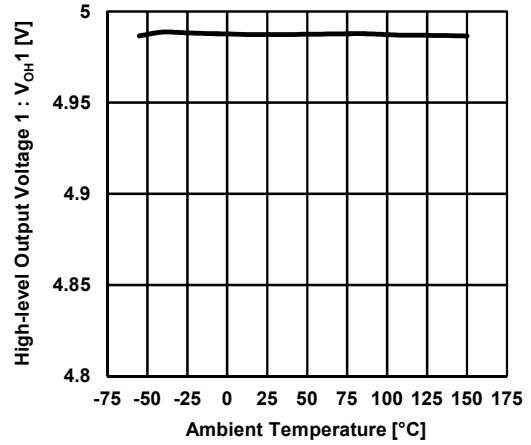

Low-level Output Voltage 1 vs. Temperature
(Common to each ver)

$V^+=5V$, $V=0V$, $R_L=10k\Omega$ to $2.5V$

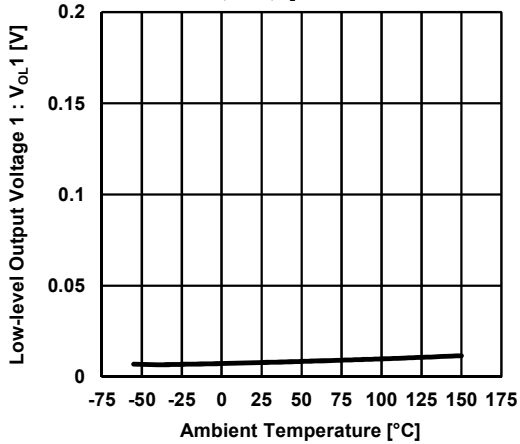

Supply Current vs. Supply Voltage
(Common to each ver)

$V^+=5V$, $V=0V$, $+HVIN=-HVIN=0V$, $G_V=0dB$, $R_L=OPEN$

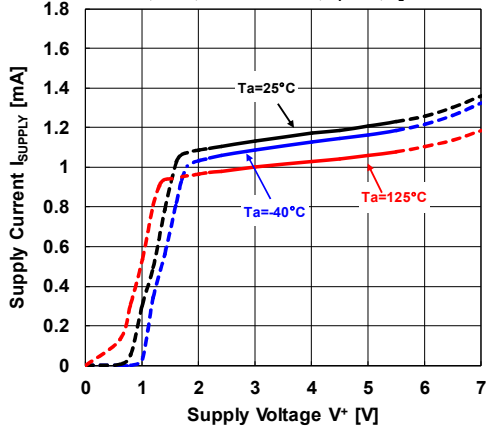

Supply Current vs. Temperature
(Common to each ver)

$V^+=5V$, $V=0V$, $+HVIN=-HVIN=0V$, $G_V=0dB$, $R_L=OPEN$

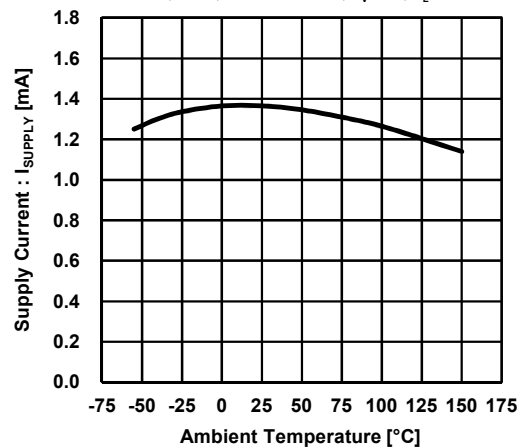

■ TYPICAL CHARACTERISTICS (General Characteristics High Voltage Monitor)

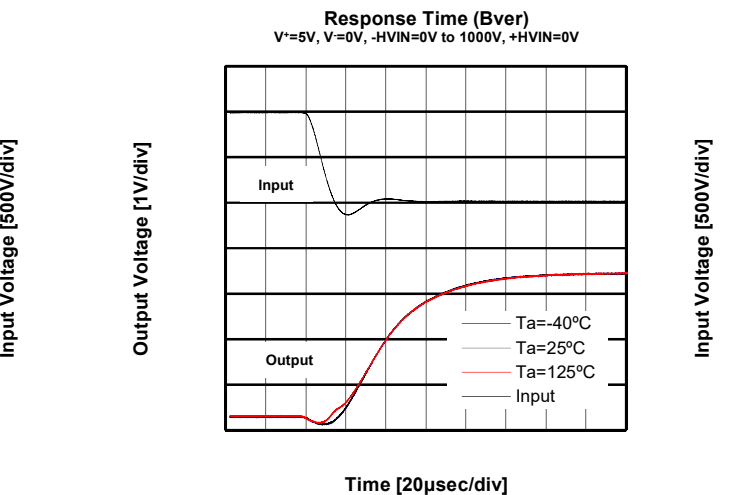
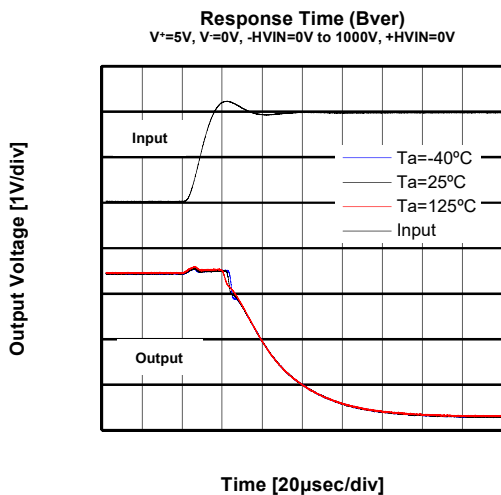
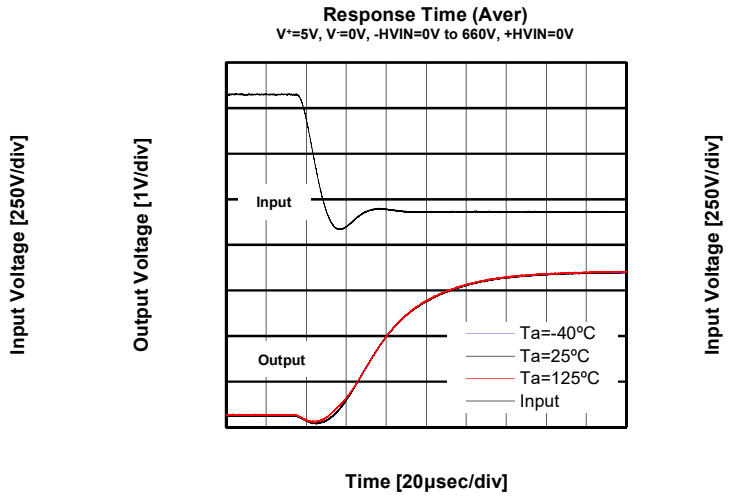
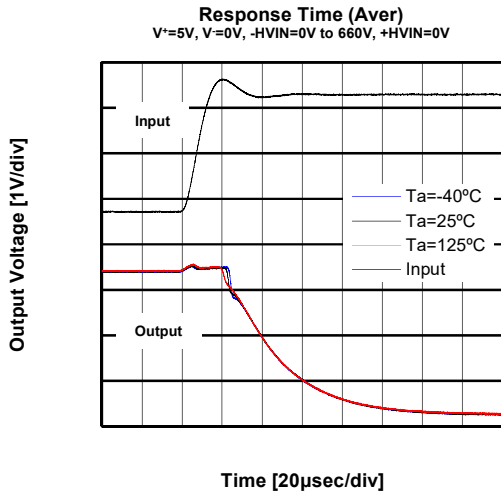

■ TYPICAL CHARACTERISTICS (Operational Amplifier)

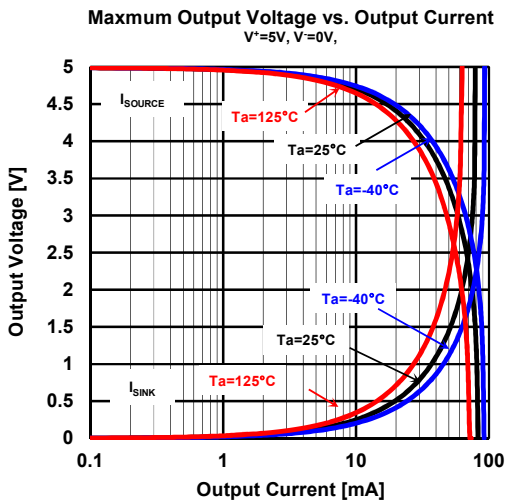
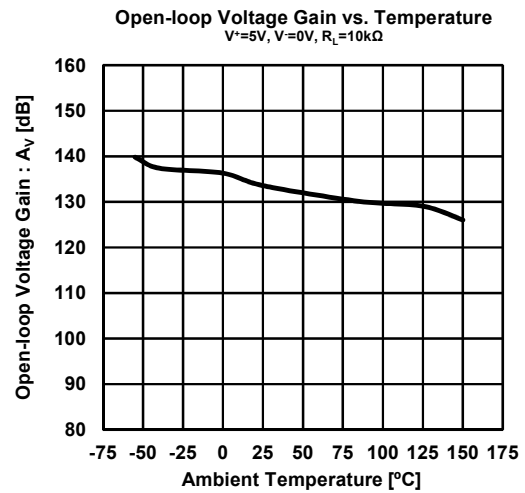
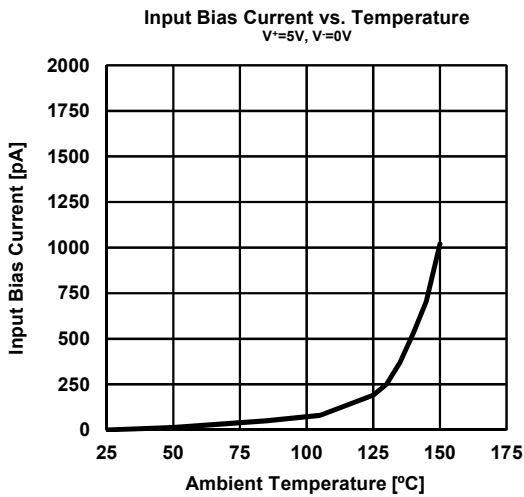
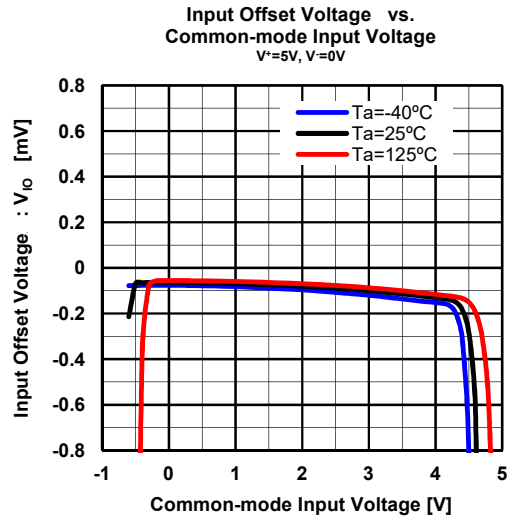
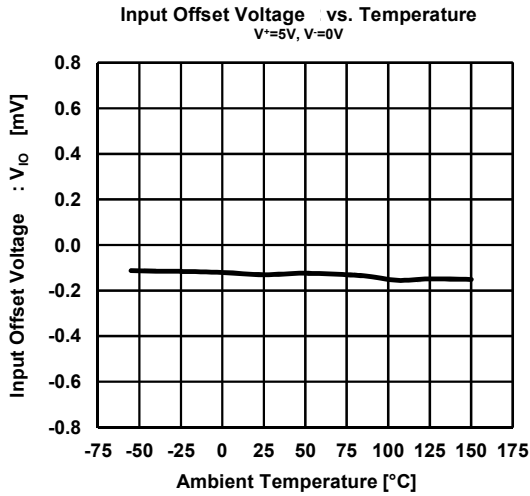

■ TYPICAL CHARACTERISTICS (Operational Amplifier)

Common Mode Rejection Ratio 2 vs. Temperature
 $V^+=5V, V^-=0V, +OPIN=0V \text{ to } 4V$

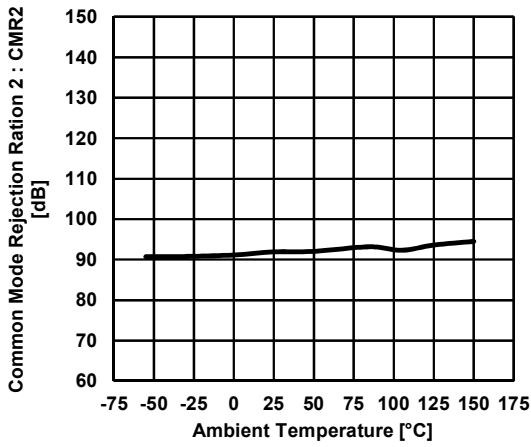

Supply Voltage Rejection Ratio 2 vs. Temperature
 $V^+=2.2V \text{ to } 5.5V, V^-=0V$

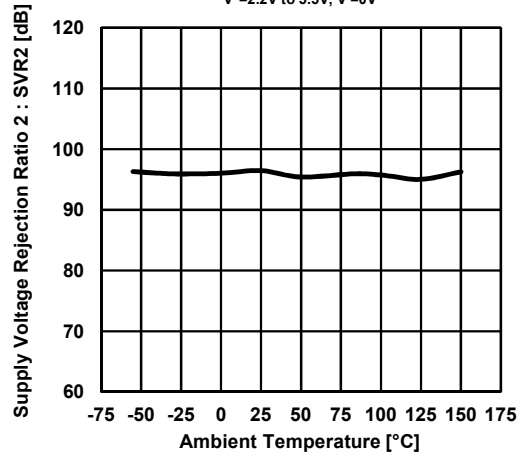

Common Mode Rejection Ratio 2 vs. Frequency
 $V^+=5V, V^-=0V, V_{IN}=1V_{pp}, R_S=100\Omega, R_F=10k\Omega, T_a=25^\circ C$

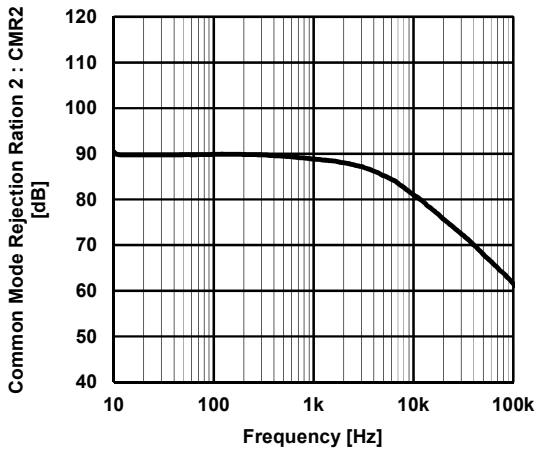

Supply Voltage Rejection Ratio 2 vs. Frequency
 $V^+=5V, V^-=0V, V_{IN}=1V_{pp}, R_S=100\Omega, R_F=10k\Omega, T_a=25^\circ C$

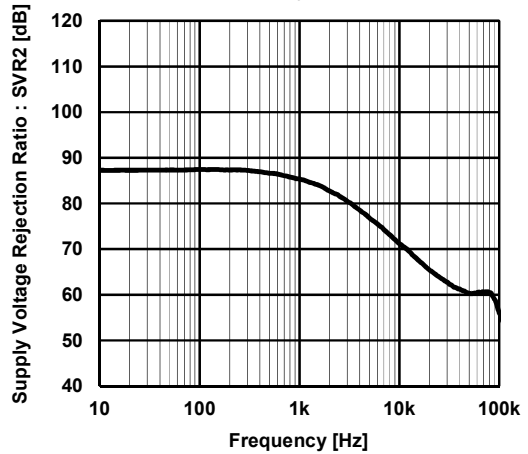

■ TYPICAL CHARACTERISTICS (Operational Amplifier)

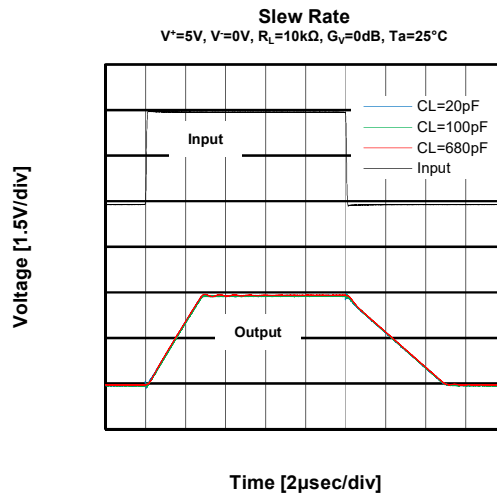
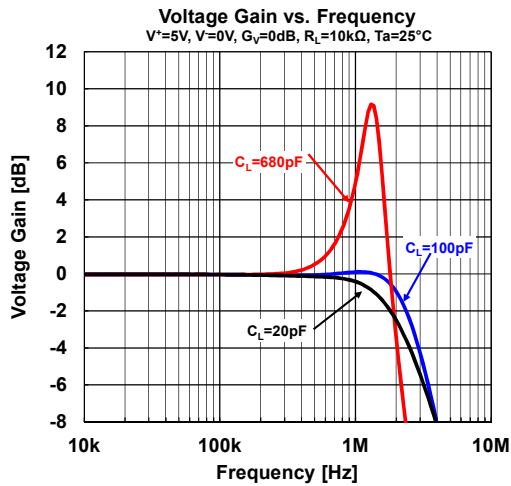
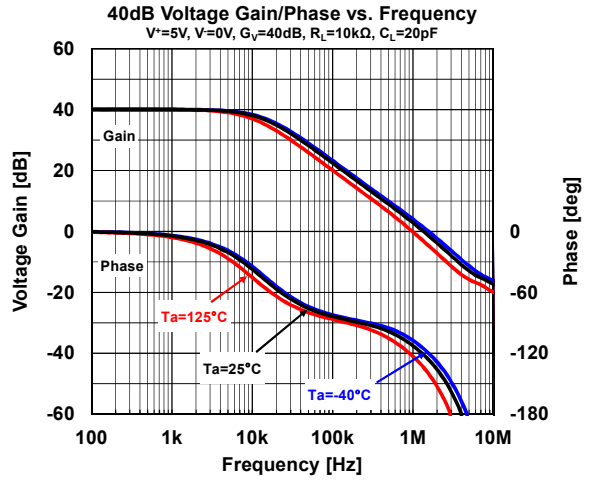
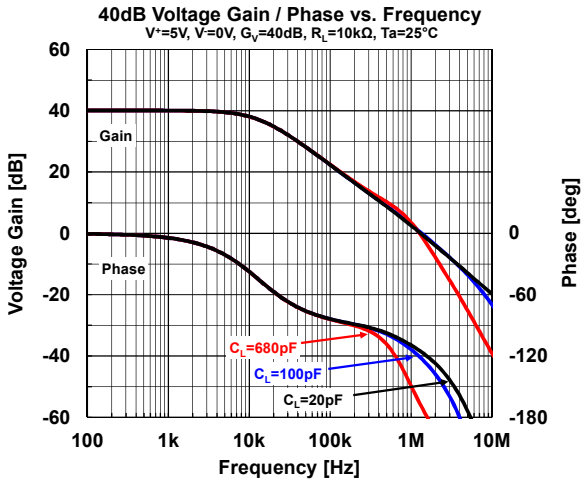

TEST CIRCUITS

- V_{IO} , CMR2, SVR2

$$R_S = 50\Omega, R_F = 50k\Omega$$

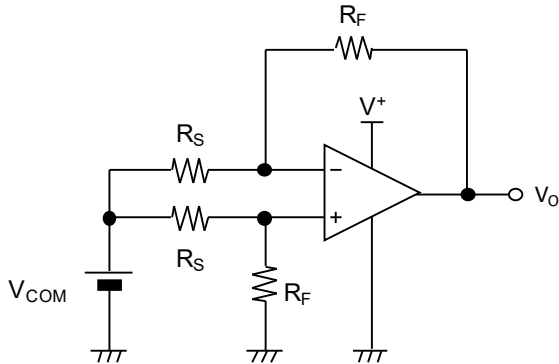

$$V_{IO} = \frac{R_S}{(R_S + R_F)} \times (V_O - V_{COM})$$

$$CMR2 = 20 \log \frac{\Delta V_{COM} \left(1 + \frac{R_F}{R_S}\right)}{\Delta V_O}$$

$$SVR2 = 20 \log \frac{\Delta V_S \left(1 + \frac{R_F}{R_S}\right)}{\Delta V_O}$$

$$V_S = V^+ - V^-$$

- GBW

$$R_S = 1k\Omega, R_F = 100k\Omega$$

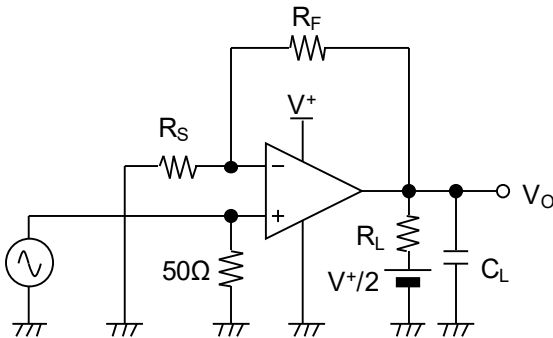

- SR

$$C_L = 20pF, R_L = 10k\Omega$$

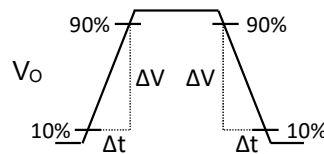
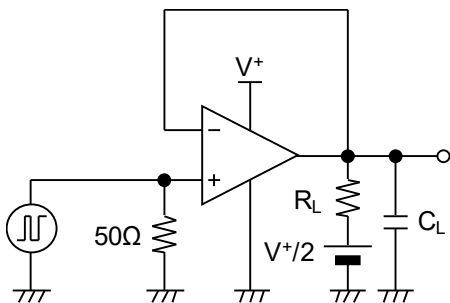

$$SR = \frac{\Delta V}{\Delta t}$$

Note on using NJU7890

This part handles high voltage, therefore it needs sufficient consideration to avoid unforeseen critical failures. Please make sure that implement and verify fail-safe and/or redundant and secure design in customer own actual application to prevent personal injury, fire and social damage. The FMEA document of this part is a highly recommended reference for application design .

■ PACKAGE DIMENSIONS

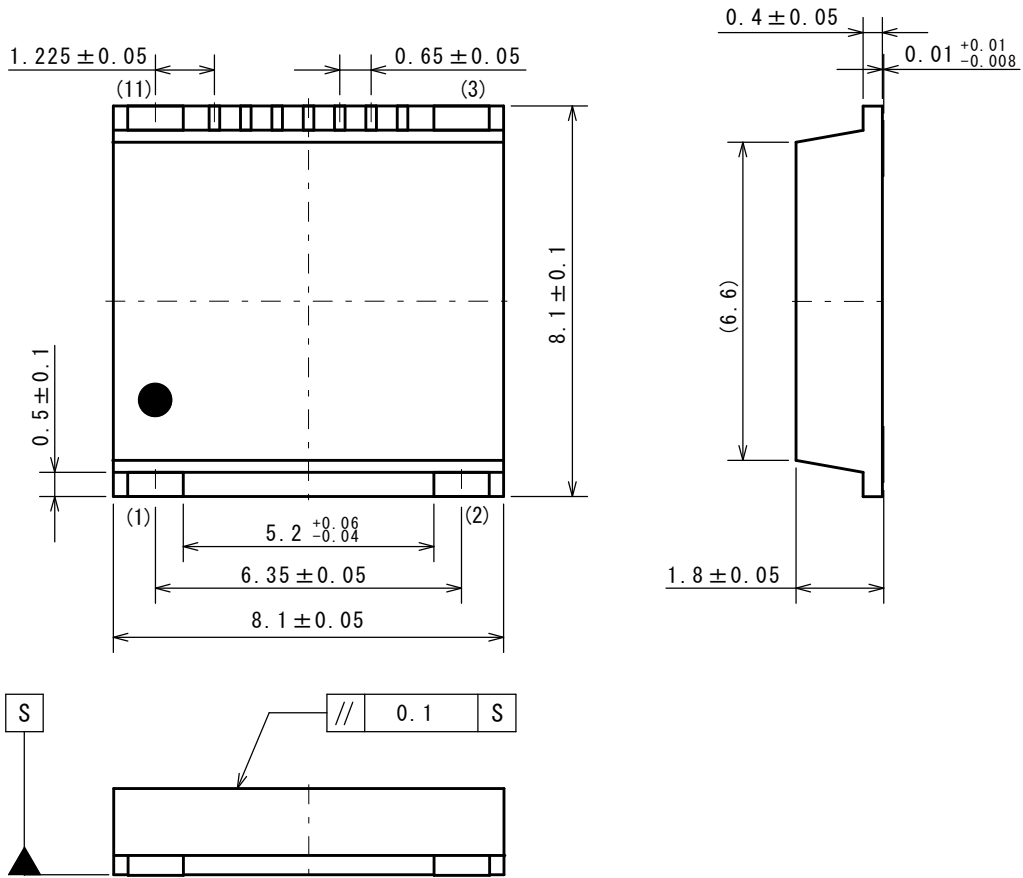

■ EXAMPLE OF SOLDER PADS DIMENSIONS

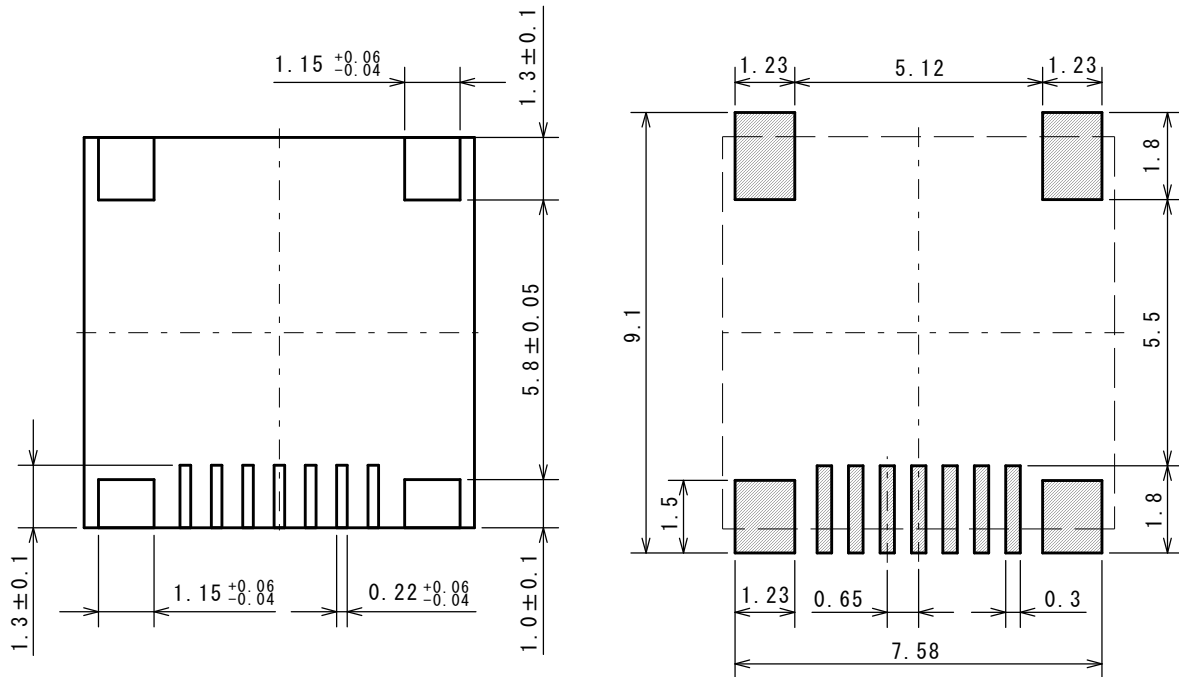

PACKING SPEC TAPING DIMENSIONS

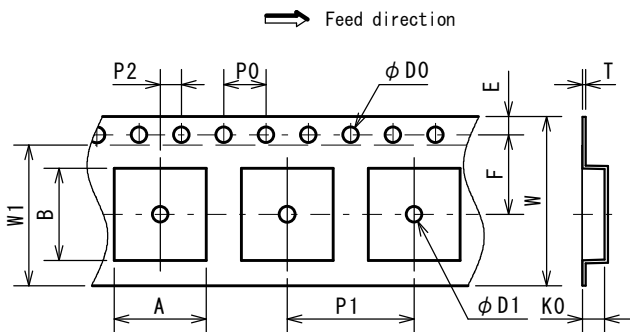

SYMBOL	DIMENSION	REMARKS
A	8.7±0.1	BOTTOM DIMENSION
B	8.7±0.1	BOTTOM DIMENSION
D0	1.5 ^{+0.1} ₀	
D1	1.5 ^{+0.1} ₀	
E	1.75±0.1	
F	7.5±0.1	
P0	4.0±0.1	
P1	12.0±0.1	
P2	2.0±0.1	
K0	2.1±0.1	
T	0.3±0.1	
W	16.0 ^{+0.3} _{-0.1}	
W1	13.3±0.1	THICKNESS 0.1max

REEL DIMENSIONS

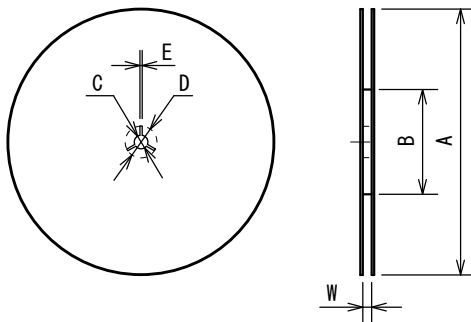

SYMBOL	DIMENSION
A	φ 330±2
B	φ 100±1
C	φ 13±0.2
D	21±0.8
E	2±0.5
W	17.5±1

TAPING STATE

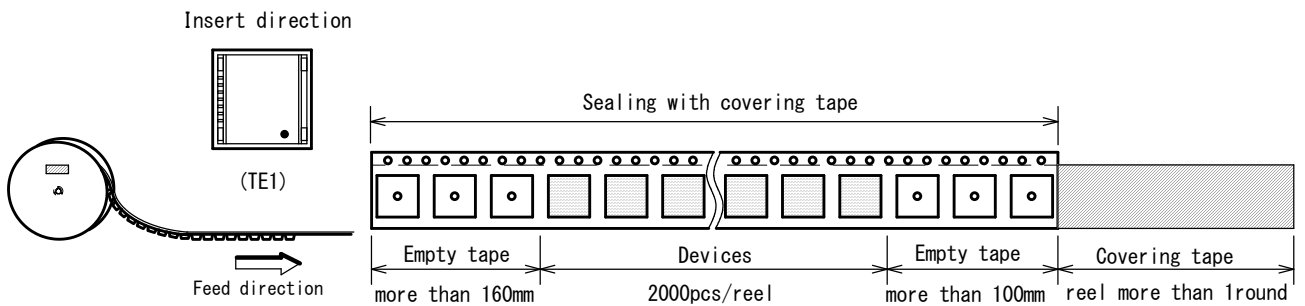

PACKING STATE

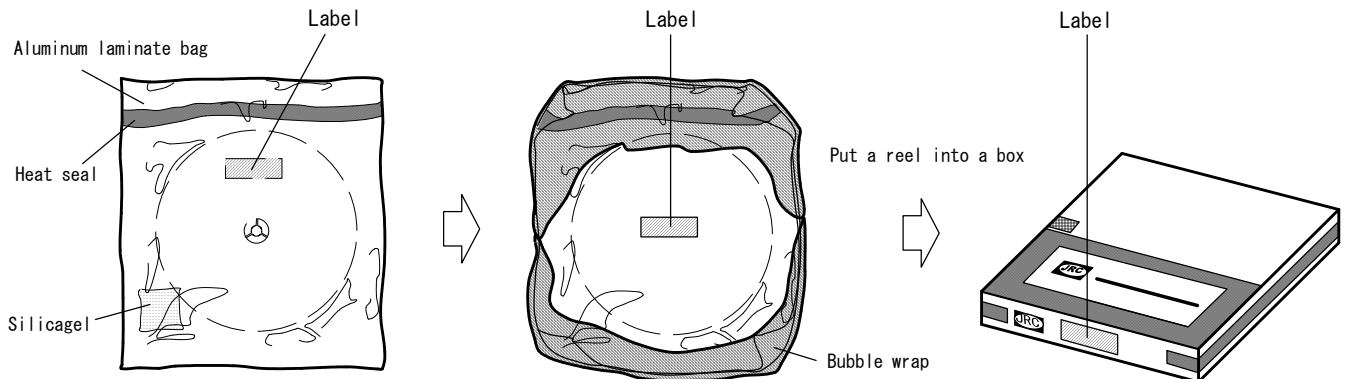

■ RECOMMENDED MOUNTING METHOD

INFRARED REFLOW SOLDERING PROFILE

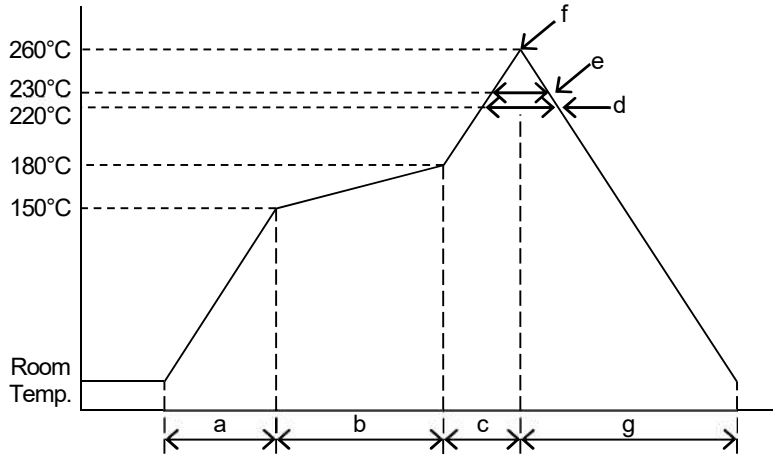

a	Temperature ramping rate	1 to 4°C/s
b	Pre-heating temperature	150 to 180°C
	Pre-heating time	60 to 120s
c	Temperature ramp rate	1 to 4°C/s
d	220°C or higher time	shorter than 60s
e	230°C or higher time	shorter than 40s
f	Peak temperature	lower than 260°C
g	Temperature ramping rate	1 to 6°C/s

The temperature indicates at the surface of mold package.

■ REVISION HISTORY

DATE	REVISION	CHANGES
February 9, 2021	Ver.1.0	Initial release
June 29,2021	Ver.2.0	Corrected FEATURES and PACKAGE DIMENSIONS

[CAUTION]

1. NJR strives to produce reliable and high quality semiconductors. NJR's semiconductors are intended for specific applications and require proper maintenance and handling. To enhance the performance and service of NJR's semiconductors, the devices, machinery or equipment into which they are integrated should undergo preventative maintenance and inspection at regularly scheduled intervals. Failure to properly maintain equipment and machinery incorporating these products can result in catastrophic system failures
2. The specifications on this datasheet are only given for information without any guarantee as regards either mistakes or omissions. The application circuits in this datasheet are described only to show representative usages of the product and not intended for the guarantee or permission of any right including the industrial property rights.
All other trademarks mentioned herein are the property of their respective companies.
3. To ensure the highest levels of reliability, NJR products must always be properly handled.
The introduction of external contaminants (e.g. dust, oil or cosmetics) can result in failures of semiconductor products.
4. NJR offers a variety of semiconductor products intended for particular applications. It is important that you select the proper component for your intended application. You may contact NJR's Sale's Office if you are uncertain about the products listed in this datasheet.
5. Special care is required in designing devices, machinery or equipment which demand high levels of reliability. This is particularly important when designing critical components or systems whose failure can foreseeably result in situations that could adversely affect health or safety. In designing such critical devices, equipment or machinery, careful consideration should be given to amongst other things, their safety design, fail-safe design, back-up and redundancy systems, and diffusion design.
6. The products listed in this datasheet may not be appropriate for use in certain equipment where reliability is critical or where the products may be subjected to extreme conditions. You should consult our sales office before using the products in any of the following types of equipment.
 - Aerospace Equipment
 - Equipment Used in the Deep Sea
 - Power Generator Control Equipment (Nuclear, steam, hydraulic, etc.)
 - Life Maintenance Medical Equipment
 - Fire Alarms / Intruder Detectors
 - Vehicle Control Equipment (Airplane, railroad, ship, etc.)
 - Various Safety Devices
7. NJR's products have been designed and tested to function within controlled environmental conditions. Do not use products under conditions that deviate from methods or applications specified in this datasheet. Failure to employ the products in the proper applications can lead to deterioration, destruction or failure of the products. NJR shall not be responsible for any bodily injury, fires or accident, property damage or any consequential damages resulting from misuse or misapplication of the products. The products are sold without warranty of any kind, either express or implied, including but not limited to any implied warranty of merchantability or fitness for a particular purpose.
8. Warning for handling Gallium and Arsenic (GaAs) Products (Applying to GaAs MMIC, Photo Reflector). These products use Gallium (Ga) and Arsenic (As) which are specified as poisonous chemicals by law. For the prevention of a hazard, do not burn, destroy, or process chemically to make them as gas or power. When the product is disposed of, please follow the related regulation and do not mix this with general industrial waste or household waste.
9. The product specifications and descriptions listed in this datasheet are subject to change at any time, without notice.

