



# P-DUKE POWER

## HAE200W Series

Half-Brick DC-DC Converter  
Up to 240 Watts

**3**  
YEARS  
WARRANTY

ROHS  
COMPLIANT

REACH  
COMPLIANT



Railway



Automation



Datacom



IPC



Industry



Measurement



Telecom



Automobile



Boat



Charger



Medical



PV



**3000 VAC**  
Reinforced  
Insulation

**3000 VDC**  
Isolation  
Voltage

**4 : 1**  
Wide  
Input  
Range

**NO**  
Min. Load  
Required

**REMOTE**  
**ON**  
**OFF**

**Sync**

**OCP**

**OTP**

**OVP**

**SCP**

**UVP**

### PART NUMBER STRUCTURE

DIP Type:

HAE200-	48	S	05	W	-	P	Y	C	HS
Series Name	Input Voltage (VDC)	Output Quantity	Output Voltage (VDC)	Input Range		Ctrl and Pin Options	SYNC Options	CASE Pin Options	Assembly Options
	24:8.5~36 9~36 48:16.5~75 110:43~160	S:Single	3P3:3.3 05:5 12:12 15:15 24:24 28:28 48:48	4:1		□:Negative logic; 0.20" pin length L:Negative logic; 0.145" pin length P:Positive logic; 0.20" pin length S:Positive logic; 0.145" pin length	□:No pin Y:SYNC	□:No pin C:CASE pin	□: None <b>Heat-sink type</b> HS: 7G-0021A-F; H=0.45" HS3: 7G-0024A-F; H=0.45" HS4: 7GA0127P01-F; H=0.65" HS5: 7GA0128P01-F; H=1" <b>Through hole type</b> TH:No thread <small>*The module can't equip Heat-sink with TH option.</small>

Wall Mounted Type:

HAE200-	48	S	05	W	-	P	TF1	R
Series Name	Input Voltage (VDC)	Output Quantity	Output Voltage (VDC)	Input Range		Ctrl and Pin Options	Assembly Options	Conformal Coating Options
	24:8.5~36 9~36 48:16.5~75 110:43~160	S:Single	3P3:3.3 05:5 12:12 15:15 24:24 28:28 48:48	4:1		□:Negative logic; 0.20" pin length P:Positive logic; 0.20" pin length	T: Without EMC filter TF1: Integrated EMC filter and meets EN55032 Class A can be connected to PE	□: None R: Conformal Coating

1. No Y and C function for terminal block type, and terminal block type only for 0.20" pin length.

**TECHNICAL SPECIFICATION** All specifications are typical at nominal input, full load and 25°C unless otherwise noted

Model Number	Input Range	Output Voltage	Output Current @Full Load	Input Current @No Load	Efficiency	Maximum Capacitor Load
	VDC	VDC	A	mA	%	μF
HAE200-24S3P3W	9 ~ 36	3.3	50	25	87	151000
HAE200-24S05W	9 ~ 36	5	36	30	90	72000
HAE200-24S12W	8.5 ~ 36	12	15	30	89	12500
HAE200-24S15W	8.5 ~ 36	15	12	30	90	8000
HAE200-24S24W	8.5 ~ 36	24	7.5	35	90	3100
HAE200-24S28W	8.5 ~ 36	28	6.5	40	90	2300
HAE200-24S48W	8.5 ~ 36	48	3.7	45	89	770
HAE200-48S3P3W	16.5 ~ 75	3.3	50	20	88	151000
HAE200-48S05W	16.5 ~ 75	5	40	20	91	80000
HAE200-48S12W	16.5 ~ 75	12	18	20	90	15000
HAE200-48S15W	16.5 ~ 75	15	14	20	91	9300
HAE200-48S24W	16.5 ~ 75	24	9	20	90	3700
HAE200-48S28W	16.5 ~ 75	28	7.5	25	91	2600
HAE200-48S48W	16.5 ~ 75	48	4.5	25	90	930
HAE200-110S3P3W	43 ~ 160	3.3	57	10	87	172000
HAE200-110S05W	43 ~ 160	5	44	10	89	88000
HAE200-110S12W	43 ~ 160	12	20	10	89	16600
HAE200-110S15W	43 ~ 160	15	16	10	90	10600
HAE200-110S24W	43 ~ 160	24	10	10	89	4100
HAE200-110S28W	43 ~ 160	28	8.5	15	90	3000
HAE200-110S48W	43 ~ 160	48	5	15	89	1000

INPUT SPECIFICATIONS							
Parameter	Conditions		Min.	Typ.	Max.	Unit	
Operating input voltage range		24Vin(nom)	3.3 & 5Vout Others	9	24	36	VDC
		48Vin(nom)		8.5	24	36	
		110Vin(nom)		16.5	48	75	
				43	110	160	
Start up voltage		24Vin(nom)			9	VDC	
		48Vin(nom)			18		
		110Vin(nom)			43		
Shutdown voltage		24Vin(nom)	7.3	7.7	8.1	VDC	
		48Vin(nom)	15.5	16	16.3		
		110Vin(nom)	33.0	34.5	36.0		
Start up time	Constant resistive load	Power up		75		ms	
		Remote ON/OFF		75			
Input surge voltage	1 second, max.	24Vin(nom)			50	VDC	
		48Vin(nom)			100		
		110Vin(nom)			185		
Input filter <sup>(1)</sup>				Pi type			
Remote ON/OFF	Referred to -Vin pin	Negative logic (Standard)	DC-DC ON	Short or 0 ~ 1.2VDC			
		Positive logic (Option)	DC-DC OFF	Open or 3 ~ 12 VDC			
			DC-DC ON	Open or 3 ~ 12 VDC			
			DC-DC OFF	Short or 0 ~ 1.2VDC			
		Input current of Ctrl pin	-0.5		1	mA	
		Remote off input current		3		mA	
Sync pin signal			-0.3		5.6	VDC	

OUTPUT SPECIFICATIONS					
Parameter	Conditions	Min.	Typ.	Max.	Unit
Voltage accuracy		-1.0		+1.0	%
Line regulation	Low Line to High Line at Full Load	-0.1		+0.1	%
Load regulation	No Load to Full Load	-0.1		+0.1	%
Voltage adjustability	Maximum output deviation is inclusive of remote sense	-20		+10	%
Remote sense	% of Vout(nom) If remote sense is not being used, Sense pins should be connected to corresponding polarity OUTPUT pins.			10	%
Ripple and noise	Measured by 20MHz bandwidth With a 1μF/25V X7R MLCC and a 22μF/25V POS-CAP 3.3Vout, 5Vout With a 1μF/25V X7R MLCC and a 22μF/25V POS-CAP 12Vout, 15Vout With a 4.7μF/50V X7R MLCC 24Vout, 28Vout With a 2.2μF/100V X7R MLCC 48Vout		75 100 200 300		mVp-p
Temperature coefficient		-0.02		+0.02	%/°C
Transient response recovery time	25% load step change		200	250	μs
Over voltage protection	% of Vout(nom); Hiccup mode	115		130	%
Over load protection	% of Iout rated; Hiccup mode	120		150	%
Short circuit protection		Continuous, automatic recovery			

GENERAL SPECIFICATIONS					
Parameter	Conditions	Min.	Typ.	Max.	Unit
Isolation voltage	1 minute (Reinforced insulation) 110Vin(nom) Input to Output	3000			VAC
	1 minute Others Input (Output) to Case	1500			VDC
		3000			VDC
		1600			VDC
Isolation resistance	500VDC	1			GΩ
Isolation capacitance				2500	pF
Switching frequency		225	250	275	kHz
Safety approvals	IEC/ EN/ UL62368-1			UL:E193009 CB:UL(Demko)	
Standard approvals	EN50155 EN45545-2				
Case material	24Vin(nom) and 48Vin(nom) 110Vin(nom)				Metal Aluminum base-plate with plastic case
Base material	24Vin(nom) and 48Vin(nom)				FR4 PCB
Potting material					Silicone (UL94 V-0)
Weight	Module stand alone HAE200-□□S□□W -T HAE200-□□S□□W -TF1			105g (3.70oz) 235g (8.29oz) 287g (10.12oz)	
MTBF	MIL-HDBK-217F, Full load				2.961×10 <sup>5</sup> hrs

ENVIRONMENTAL SPECIFICATIONS					
Parameter	Conditions	Min.	Typ.	Max.	Unit
Operating case temperature	Base-plate	-40		+115	°C
Maximum case temperature				115	°C
Over temperature protection			120		°C
Storage temperature range	Terminal block type	-40		+105	°C
	Others	-55		+125	°C
Thermal impedance	Module without assembly option Only mount on the iron base-plate Heat-sink type with 0.45" Height Heat-sink type with 0.65" Height Heat-sink type with 1" Height		6.1 2.8 4.6 3.2 2.5		°C/W
Thermal shock					MIL-STD-810F
Shock					EN61373, MIL-STD-810F
Vibration					EN61373, MIL-STD-810F
Relative humidity					5% to 95% RH

EMC SPECIFICATIONS		
Parameter	Conditions	Level
EMI	EN55032, EN50121-3-2 HAE200-□□S□□W-TF1 Other models; with external components	Class A Class A, Class B
*Connecting four screw bolts to shield plane will help to reduce the EMI.		
EMS	EN55035, EN50121-3-2	
ESD	EN61000-4-2 Air ± 8kV and Contact ± 6kV	Perf. Criteria A
Radiated immunity	EN61000-4-3 20V/m	Perf. Criteria A
Fast transient	EN61000-4-4 ± 2kV	Perf. Criteria A
Surge	HAE200-24S□□W HAE200-48S□□W	With 2 pcs of aluminum electrolytic capacitor (Nippon Chemi-con KY series, 220μF/100V)
	HAE200-110S□□W	With 2 pcs of aluminum electrolytic capacitor (Nippon Chemi-con KXJ series, 150μF/200V)
	EN61000-4-5	±2kV
Conducted immunity	HAE200-24S□□W HAE200-48S□□W	With 2 pcs of aluminum electrolytic capacitor (Nippon Chemi-con KY series, 220μF/100V)
	HAE200-110S□□W	With 2 pcs of aluminum electrolytic capacitor (Nippon Chemi-con KXJ series, 150μF/200V)
	EN61000-4-6	10Vr.m.s
Power frequency magnetic field	EN61000-4-8 100A/m continuous; 1000A/m 1 second	Perf. Criteria A

**Note:**

- Input source impedance: The power module will operate as specifications without external components, assuming that the source voltage has a very low impedance and reasonable input voltage regulation. Highly inductive source impedances can affect the stability of the power module. Since real-world voltage source has finite impedance, performance can be improved by adding external filter capacitor. The HAE200-24S□□W and HAE200-48S□□W recommended Nippon Chemi-con KY series, 100μF/100V. The HAE200-110S□□W recommended Ruby-con BXF series, 68μF/200V.

**CAUTION:** This power module is not internally fused. An input line fuse must always be used.

## CHARACTERISTIC CURVE

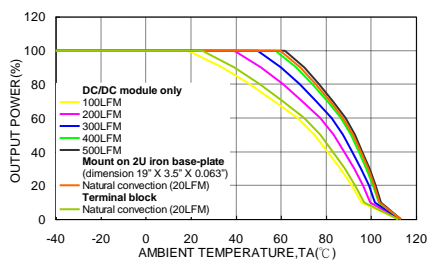

HAE200-48S05W Derating Curve  
(See Thermal Considerations)

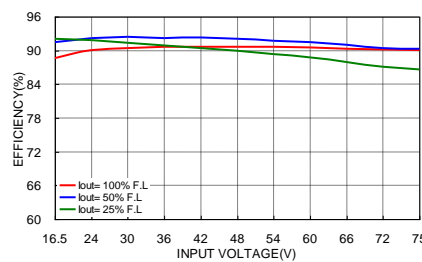

HAE200-48S05W Efficiency vs. Input Voltage

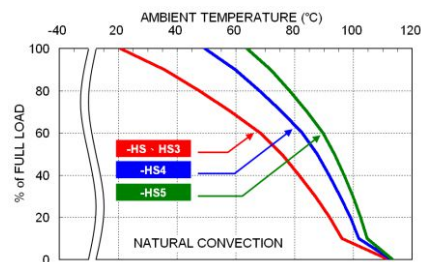

HAE200-48S05W Derating Curve with Heat-sink  
(See Thermal Considerations)

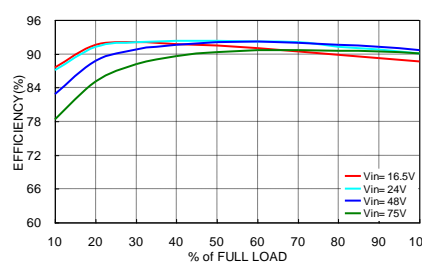

HAE200-48S05W Efficiency vs. Output Load

## FUSE CONSIDERATION

This power module is not internally fused. An input line fuse must always be used.

This encapsulated power module can be used in a wide variety of applications, ranging from simple stand-alone operation to an integrated part of sophisticated power architecture.

To maximum flexibility, internal fusing is not included; however, to achieve maximum safety and system protection, always use an input line fuse.

The input line fuse suggest as below :

Model	Fuse Rating (A)	Fuse Type
HAE200-24S□□W	32	Fast-Acting
HAE200-48S□□W	20	Fast-Acting
HAE200-110S□□W	10	Fast-Acting

The table based on the information provided in this data sheet on inrush energy and maximum DC input current at low Vin.

## MECHANICAL DRAWING

### HAE200-24S□□W, HAE200-48S□□W

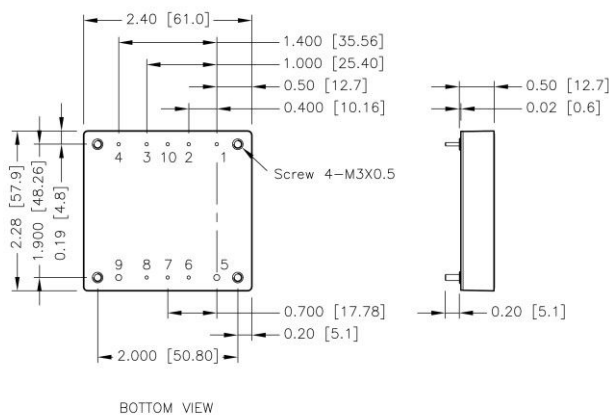

BOTTOM VIEW

- The screw locked torque: MAX 5.0kgf-cm/0.49N-m

### HAE200-110S□□W

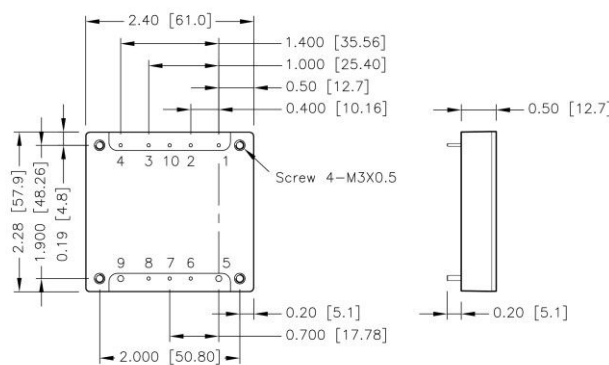

BOTTOM VIEW

- The screw locked torque: MAX 3.5kgf-cm/0.34N-m

### PIN CONNECTION

PIN	DEFINE	DIAMETER
1	-Vin	0.04 Inch
2	Case (option)	0.04 Inch
3	Ctrl	0.04 Inch
4	+Vin	0.04 Inch
5	-Vout	0.08 Inch
6	-Sense	0.04 Inch
7	Trim	0.04 Inch
8	+Sense	0.04 Inch
9	+Vout	0.08 Inch
10	Sync (option)	0.04 Inch

- All dimensions in inch [mm]
- Tolerance :x.xx±0.02 [x.x±0.5]  
x.xxx±0.01 [x.xx±0.25]
- Pin dimension tolerance ±0.004[0.10]

**TERMINAL BLOCK TYPE OPTION**

**HAE200-□□S□□W -T**

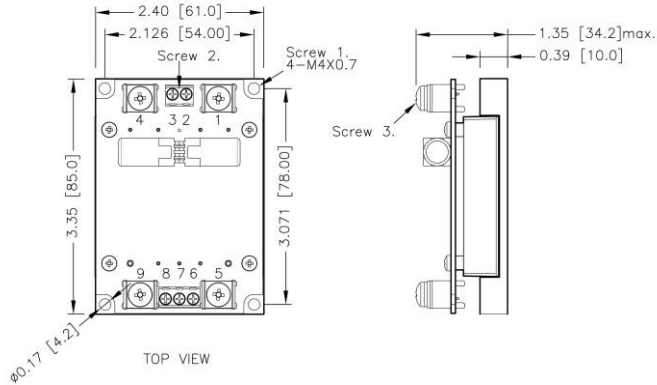

**HAE200-□□S□□W -TF1**

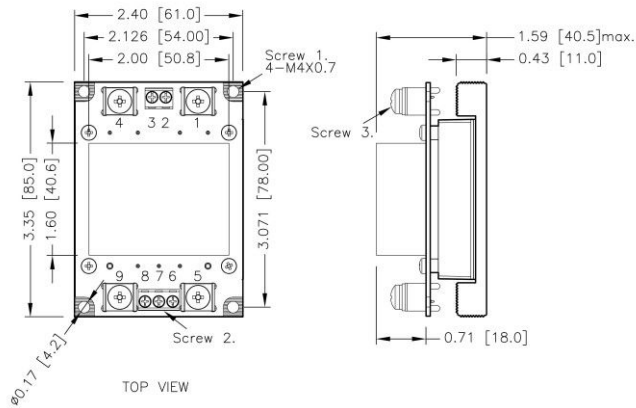

**TERMINAL CONNECTION**

NO.	DEFINE
1	-Vin
2	NC
3	Ctrl
4	+Vin
5	-Vout
6	-Sense
7	Trim
8	+Sense
9	+Vout

- All dimensions in inch [mm]
- Tolerance :x.xx±0.02 [x.x±0.5]  
x.xxx±0.01 [x.xx±0.25]
- Screw 1 locked torque:  
MAX 11.2kgf-cm/ 1.10N-m
- Screw 2 locked torque:  
MAX 5.2kgf-cm/ 0.51N-m
- Screw 3 locked torque:  
MAX 16.8kgf-cm/ 1.65N-m

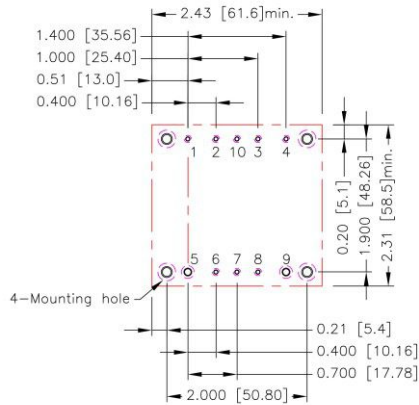
**RECOMMENDED PAD LAYOUT**

All dimensions in inch[mm]  
 Pad size(lead free recommended)  
 Through hole 1,2,3,4,6,7,8,10:  $\Phi 0.051$ [1.30]  
 Through hole 5,9:  $\Phi 0.091$ [2.30]  
 Through hole of mounting:  $\Phi 0.126$ [3.20]  
 Top view pad 1,2,3,4,6,7,8,10:  $\Phi 0.064$ [1.63]  
 Top view pad 5,9:  $\Phi 0.113$ [2.88]  
 Top view pad of mounting:  $\Phi 0.157$ [4.00]  
 Bottom view pad 1,2,3,4,6,7,8,10:  $\Phi 0.102$ [2.60]  
 Bottom view pad 5,9:  $\Phi 0.181$ [4.60]  
 Bottom view pad of mounting:  $\Phi 0.252$ [6.40]

**THERMAL CONSIDERATIONS**

The power module operates in a variety of thermal environments.

However, sufficient cooling should be provided to help ensure reliable operation of the unit.

Heat is removed by conduction, convection, and radiation to the surrounding environment.

Proper cooling can be verified by measuring the point as the figure below.

The temperature at this location should not exceed "Maximum case temperature".

When operating, adequate cooling must be provided to maintain the test point temperature at or below "Maximum case temperature".

You can limit this temperature to a lower value for extremely high reliability.

- Thermal test condition with vertical direction by natural convection (20LFM).
- The iron base-plate dimension is 19" X 3.5" X 0.063" (The height is EIA standard 2U).
- The heat-sink is optional and P/N: 7G-0021A-F, 7G-0024A-F, 7GA0127P01-F, 7GA0128P01-F.

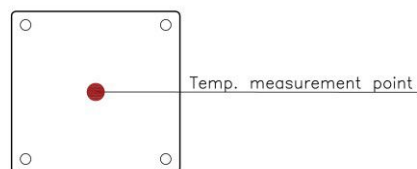

BASE PLATE

## HEAT-SINK TYPE OPTIONS

HAE200-□□S□□W -HS  
7G-0021A-F

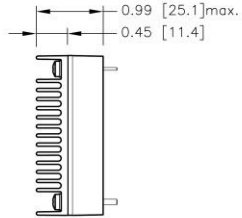
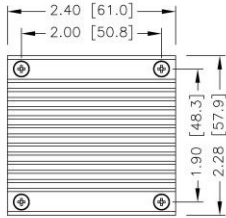

SIDE VIEW

HAE200-□□S□□W -HS3  
7G-0024A-F

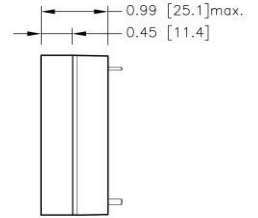
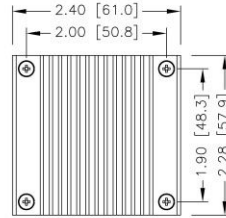

SIDE VIEW

HAE200-□□S□□W -HS4  
7GA0127P01-F

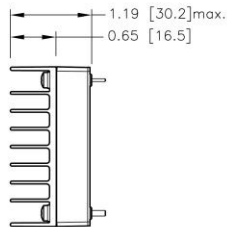
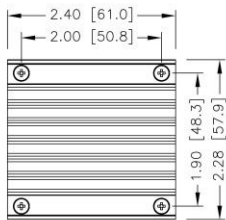

SIDE VIEW

HAE200-□□S□□W -HS5  
7GA0128P01-F

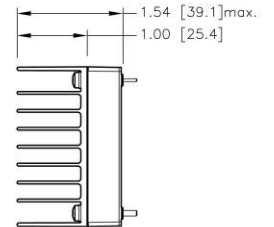
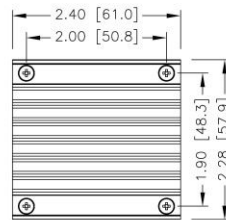

SIDE VIEW

1. All dimensions in inch [mm]
2. Tolerance :x.xx±0.02 [x.x±0.5]  
x.xxx±0.01 [x.xx±0.25]



## OUTPUT VOLTAGE ADJUSTMENT

Output voltage is adjustable for 10% trim up or -20% trim down of nominal output voltage by connecting an external resistor between the Trim pin and either the +Sense or -Sense pins.

With an external resistor between the Trim and -Sense pin, the output voltage set point decreases.

With an external resistor between the Trim and +Sense pin, the output voltage set point increases.

Maximum output deviation is +10% inclusive of remote sense.

The external Trim resistor needs to be at least 1/8W of rated power.

### Trim Up Equation

$$R_U = \left( \frac{V_{OUT}(100 + \Delta\%) - 100 + 2\Delta\%}{1.225\Delta\%} - \frac{100 + 2\Delta\%}{\Delta\%} \right) k\Omega$$

### Trim Down Equation

$$R_D = \left( \frac{100}{\Delta\%} - 2 \right) k\Omega$$

## EXTERNAL OUTPUT TRIMMING

Output can be externally trimmed by using the method shown below.

Trim-up

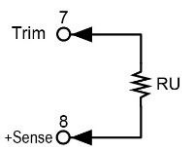

#### □□S3P3W

$\Delta V$ (%)	1	2	3	4	5	6	7	8	9	10
Vout (V)	3.333	3.366	3.399	3.432	3.465	3.498	3.531	3.564	3.597	3.630
RU (kΩ)	170.082	85.388	57.156	43.041	34.571	28.925	24.892	21.867	19.515	17.633

#### □□S05W

$\Delta V$ (%)	1	2	3	4	5	6	7	8	9	10
Vout (V)	5.05	5.10	5.15	5.20	5.25	5.30	5.35	5.40	5.45	5.50
RU (kΩ)	310.245	156.163	104.803	79.122	63.714	53.442	46.105	40.602	36.322	32.898

#### □□S12W

$\Delta V$ (%)	1	2	3	4	5	6	7	8	9	10
Vout (V)	12.12	12.24	12.36	12.48	12.60	12.72	12.84	12.96	13.08	13.20
RU (kΩ)	887.388	447.592	300.993	227.694	183.714	154.395	133.452	117.745	105.528	95.755

#### □□S15W

$\Delta V$ (%)	1	2	3	4	5	6	7	8	9	10
Vout (V)	15.15	15.30	15.45	15.60	15.75	15.90	16.05	16.20	16.35	16.50
RU (kΩ)	1134.735	572.490	385.075	291.367	235.143	197.660	170.886	150.806	135.188	122.694

#### □□S24W

$\Delta V$ (%)	1	2	3	4	5	6	7	8	9	10
Vout (V)	24.24	24.48	24.72	24.96	25.20	25.44	25.68	25.92	26.16	26.40
RU (kΩ)	1876.776	947.184	637.320	482.388	389.429	327.456	283.190	249.990	224.168	203.510

#### □□S28W

$\Delta V$ (%)	1	2	3	4	5	6	7	8	9	10
Vout (V)	28.28	28.56	28.84	29.12	29.40	29.68	29.96	30.24	30.52	30.80
RU (kΩ)	2206.571	1113.714	749.429	567.286	458.000	385.143	333.102	294.071	263.714	239.429

#### □□S48W

$\Delta V$ (%)	1	2	3	4	5	6	7	8	9	10
Vout (V)	48.48	48.96	49.44	49.92	50.40	50.88	51.36	51.84	52.32	52.80
RU (kΩ)	3855.551	1946.367	1309.973	991.776	800.857	673.578	582.665	514.480	461.447	419.020

**OUTPUT VOLTAGE ADJUSTMENT(CONTINUED)**

Trim-down

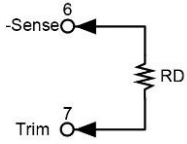

□□S□W

$\Delta V$ (%)	1	2	3	4	5	6	7	8	9	10
RD (k $\Omega$ )	98.000	48.000	31.333	23.000	18.000	14.667	12.286	10.500	9.111	8.000
$\Delta V$ (%)	11	12	13	14	15	16	17	18	19	20
RD (k $\Omega$ )	7.091	6.333	5.692	5.143	4.667	4.250	3.882	3.556	3.263	3.000

**SYNCHRONOUS PIN**

Multiple module can be synchronized together simply by connecting the module SYNC pins together.

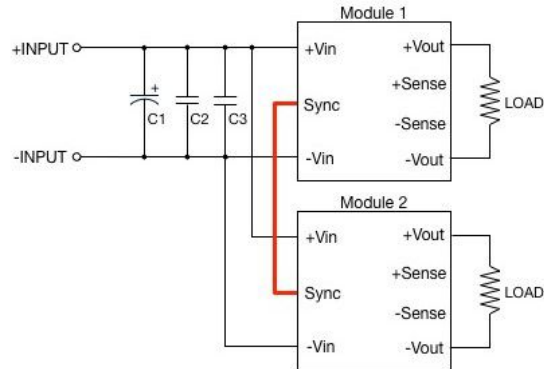

Synchronous Circuits

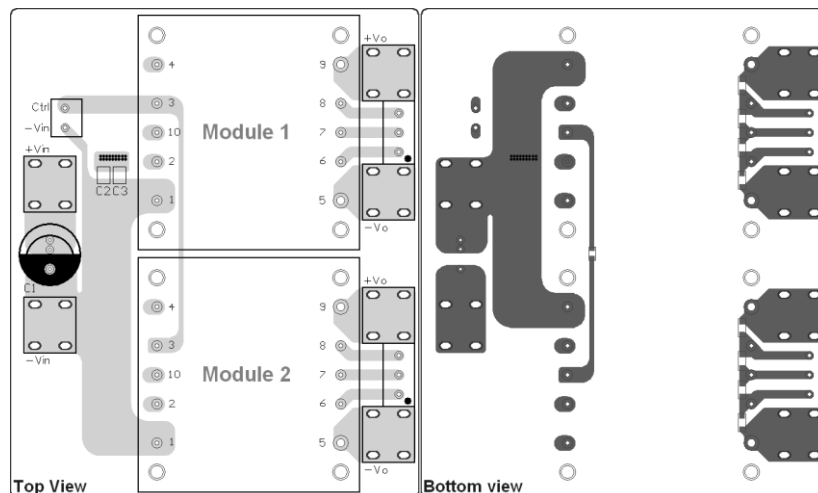

Recommended Layout

HAE200-24S□□W-Y、HAE200-48S□□W-Y

Component	Value	Voltage	Reference
C1	220 $\mu$ F	100V	Nippon chemi-con KY-series
C2、C3	2.2 $\mu$ F	100V	1812 MLCC

HAE200-110S□□W-Y

Component	Value	Voltage	Reference
C1	150 $\mu$ F	200V	Nippon chemi-con KXJ-series
C2、C3	1 $\mu$ F	250V	1812 MLCC

- Care should be taken to ensure the ground potential differences between modules are minimized.
- All of the modules in this configuration will be synchronized to the highest frequency module.
- Up to three modules can be synchronized using this technique.