



# P-DUKE POWER

## HAE75W Series

Half-Brick DC-DC Converter  
Up to 75 Watts

**3**  
YEARS  
WARRANTY

ROHS  
COMPLIANT

REACH  
COMPLIANT



Railway



Automation



Datacom



IPC



Industry



Measurement



Telecom



Automobile



Boat



Charger



Medical



PV



**3000 VAC**  
Reinforced  
Insulation

**3000 VDC**  
Isolation  
Voltage

**4 : 1**  
Wide  
Input  
Range

**NO**  
Min. Load  
Required

**REMOTE**  
**ON**  
**OFF**

**OCP**

**OTP**

**OVP**

**SCP**

**UVP**

### PART NUMBER STRUCTURE

DIP Type:

HAE75	-	48	S	05	W	-	P	-	HS
Series Name		Input Voltage (VDC)	Output Quantity	Output Voltage (VDC)	Input Range		Ctrl and Pin Options		Assembly Options
		24:9-36 48:18-75 110:43-160	S:Single	3P3:3.3 05:5 12:12 15:15 24:24 28:28 48:48	4:1		□: Negative logic; 0.20" pin length L: Negative logic; 0.145" pin length P: Positive logic; 0.20" pin length S: Positive logic; 0.145" pin length		□: None <b>Heat-sink type</b> <b>HS:</b> 7G-0021A-F; H=0.45" <b>HS3:</b> 7G-0024A-F; H=0.45" <b>HS4:</b> 7GA0127P01-F; H=0.65" <b>HS5:</b> 7GA0128P01-F; H=1" Through hole type <b>TH:</b> No thread* *The module can't equip Heat-sink with TH option.

Wall Mounted Type:

HAE75	-	48	S	05	W	-	P	-	TF1	-	R
Series Name		Input Voltage (VDC)	Output Quantity	Output Voltage (VDC)	Input Range		Ctrl and Pin Options		Assembly Options		Conformal Coating Options
		24:9-36 48:18-75 110:43-160	S:Single	3P3:3.3 05:5 12:12 15:15 24:24 28:28 48:48	4:1		□: Negative logic; 0.20" pin length P: Positive logic; 0.20" pin length		T: Without EMC filter <b>TF1:</b> Integrated EMC filter and meets EN55032 Class A can be connected to PE		□: None <b>R:</b> Conformal Coating

1. The terminal block type is only for assembly of 0.20 "pin length.

**TECHNICAL SPECIFICATION** All specifications are typical at nominal input, full load and 25°C unless otherwise noted

Model Number	Input Range	Output Voltage	Output Current @Full Load	Input Current @No Load	Efficiency	Maximum Capacitor Load
	VDC	VDC	A	mA	%	μF
HAE75-24S3P3W	9 ~ 36	3.3	20	85	87	60600
HAE75-24S05W	9 ~ 36	5	15	120	88	30000
HAE75-24S12W	9 ~ 36	12	6.3	185	88	5250
HAE75-24S15W	9 ~ 36	15	5	185	88	3330
HAE75-24S24W	9 ~ 36	24	3.2	85	87	1330
HAE75-24S28W	9 ~ 36	28	2.7	85	87	960
HAE75-24S48W	9 ~ 36	48	1.6	85	87	330
HAE75-48S3P3W	18 ~ 75	3.3	20	60	88	60600
HAE75-48S05W	18 ~ 75	5	15	60	90	30000
HAE75-48S12W	18 ~ 75	12	6.3	90	90	5250
HAE75-48S15W	18 ~ 75	15	5	50	89	3330
HAE75-48S24W	18 ~ 75	24	3.2	50	88	1330
HAE75-48S28W	18 ~ 75	28	2.7	50	88	960
HAE75-48S48W	18 ~ 75	48	1.6	50	87	330
HAE75-110S3P3W	43 ~ 160	3.3	20	10	89	60600
HAE75-110S05W	43 ~ 160	5	15	10	91	30000
HAE75-110S12W	43 ~ 160	12	6.3	10	91	5250
HAE75-110S15W	43 ~ 160	15	5	10	91	3330
HAE75-110S24W	43 ~ 160	24	3.2	10	90	1330
HAE75-110S28W	43 ~ 160	28	2.7	10	90	960
HAE75-110S48W	43 ~ 160	48	1.6	10	90	330

INPUT SPECIFICATIONS						
Parameter	Conditions		Min.	Typ.	Max.	Unit
Operating input voltage range	24Vin(nom)		9	24	36	VDC
	48Vin(nom)		18	48	75	
	110Vin(nom)		43	110	160	
Start up voltage	24Vin(nom)				9	VDC
	48Vin(nom)				18	
	110Vin(nom)				43	
Shutdown voltage	24Vin(nom)		7.3	7.7	8.1	VDC
	48Vin(nom)		15.5	16	16.3	
	110Vin(nom)		33.0	34.5	36.0	
Start up time	Constant resistive load	Power up	110Vin(nom)		60	ms
		Others			25	
		Remote ON/OFF	110Vin(nom)		60	
Input surge voltage	1 second, max.	24Vin(nom)			50	VDC
		48Vin(nom)			100	
		110Vin(nom)			185	
Input filter <sup>(1)</sup>			Pi type			
Remote ON/OFF	Referred to -Vin pin	Negative logic (Standard)	DC-DC ON	Short or 0 ~ 1.2VDC		
		Positive logic (Option)	DC-DC OFF	Open or 3 ~ 12 VDC		
			DC-DC ON	Open or 3 ~ 12 VDC		
		DC-DC OFF	Short or 0 ~ 1.2VDC			
		Input current of Ctrl pin	-0.5		1	mA
		Remote off input current		3		mA

OUTPUT SPECIFICATIONS						
Parameter	Conditions		Min.	Typ.	Max.	Unit
Voltage accuracy			-1.0		+1.0	%
Line regulation	Low Line to High Line at Full Load		-0.1		+0.1	%
Load regulation	No Load to Full Load		-0.1		+0.1	%
Voltage adjustability	Maximum output deviation is inclusive of remote sense		-20		+10	%
Remote sense	% of Vout(nom) If remote sense is not being used, Sense pins should be connected to corresponding polarity OUTPUT pins.				10	%
Ripple and noise	Measured by 20MHz bandwidth With a 4.7µF/50V X7R MLCC With a 4.7µF/50V X7R MLCC With a 4.7µF/50V X7R MLCC With a 2.2µF/100V X7R MLCC			3.3Vout, 5Vout 12Vout, 15Vout 24Vout, 28Vout 48Vout	75 100 200 300	100 125 250 350 mVp-p
Temperature coefficient			-0.02		+0.02	%/°C
Transient response recovery time	25% load step change			200	250	µs
Over voltage protection	% of Vout(nom); Hiccup mode		115		130	%
Over load protection	% of Iout rated; Hiccup mode			110Vin(nom) Others	150 140	%
Short circuit protection			Continuous, automatic recovery			

GENERAL SPECIFICATIONS						
Parameter	Conditions		Min.	Typ.	Max.	Unit
Isolation voltage	1 minute(Reinforced insulation)	110Vin(nom)	3000			VAC
	1 minute	Others	1500			VDC
Isolation resistance	500VDC		3000			GΩ
Isolation capacitance			1600		2500	pF
Switching frequency			270	300	330	kHz
Safety approvals	IEC/ EN/ UL62368-1					UL:E193009 CB:UL(Demko)
Standard approvals	EN50155 EN45545-2					
Case material	24Vin(nom) and 48Vin(nom) 110Vin(nom)		Aluminum base-plate with plastic case			Metal
Base material	24Vin(nom) and 48Vin(nom)					FR4 PCB
Potting material						Silicone (UL94 V-0)
Weight	Module stand alone HAE75-□□S□□W -T HAE75-□□S□□W -TF1					97g (3.42oz) 200g (7.05oz) 287g (10.12oz)
MTBF	MIL-HDBK-217F, Full load					3.362×10 <sup>5</sup> hrs

ENVIRONMENTAL SPECIFICATIONS						
Parameter	Conditions		Min.	Typ.	Max.	Unit
Operating case temperature	Base-plate		-40		+105	°C
Maximum case temperature					105	°C
Over temperature protection				115		°C
Storage temperature range	Terminal block type		-40		+105	°C
	Others		-55		+125	
Thermal impedance	Module without assembly options			6.7		°C/W
	Heat-sink type with 0.45" Height			4.7		
	Heat-sink type with 0.65" Height			3.7		
	Heat-sink type with 1" Height			3.0		
Thermal shock						MIL-STD-810F
Shock						EN61373, MIL-STD-810F
Vibration						EN61373, MIL-STD-810F
Relative humidity						5% to 95% RH

EMC SPECIFICATIONS			
Parameter	Conditions	Level	
EMI	EN55032, EN50121-3-2 HAE75-□□S□□W-TF1 Other models; with external components  *Connecting four screw bolts to shield plane will help to reduce the EMI.	Class A Class A, Class B	
EMS	EN55035, EN50121-3-2		
ESD	EN61000-4-2 Air ± 8kV and Contact ± 6kV	Perf. Criteria A	
Radiated immunity	EN61000-4-3 20V/m	Perf. Criteria A	
Fast transient	EN61000-4-4 ± 2kV	Perf. Criteria A	
	HAE75-24S□□W HAE75-48S□□W		With 2 pcs of aluminum electrolytic capacitor (Nippon Chemi-con KY series, 220μF/100V)
	HAE75-110S□□W		With 2 pcs of aluminum electrolytic capacitor (Nippon Chemi-con KXJ series, 150μF/200V)
Surge	EN61000-4-5 ±2kV	Perf. Criteria A	
	HAE75-24S□□W HAE75-48S□□W		With 2 pcs of aluminum electrolytic capacitor (Nippon Chemi-con KY series, 220μF/100V)
	HAE75-110S□□W		With 2 pcs of aluminum electrolytic capacitor (Nippon Chemi-con KXJ series, 150μF/200V)
Conducted immunity	EN61000-4-6 10Vr.m.s	Perf. Criteria A	
Power frequency magnetic field	EN61000-4-8 100A/m continuous; 1000A/m 1 second	Perf. Criteria A	

**Note:**

- Input source impedance: The power module will operate as specifications without external components, assuming that the source voltage has a very low impedance and reasonable input voltage regulation. Highly inductive source impedances can affect the stability of the power module. Since real-world voltage source has finite impedance, performance can be improved by adding external filter capacitor. The HAE75-24S□□W recommended 4.7μF/50V X7R MLCC or Nippon Chemi-con KY series, 68μF /100V or better capacitor.

**CAUTION:** This power module is not internally fused. An input line fuse must always be used.

## CHARACTERISTIC CURVE

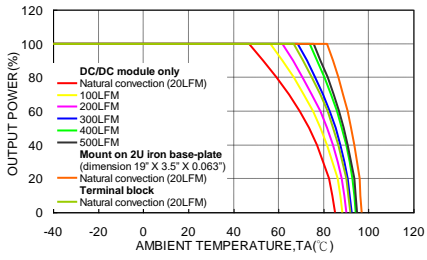

HAE75-48S05W Derating Curve  
(See Thermal Considerations)

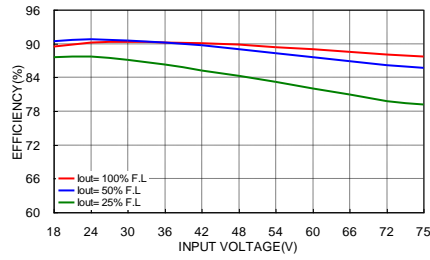

HAE75-48S05W Efficiency vs. Input Voltage

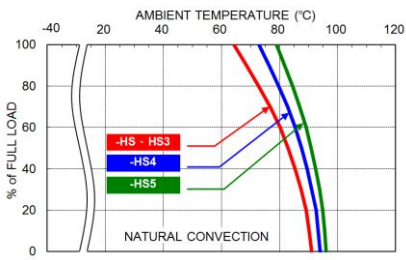

HAE75-48S05W Derating Curve with Heat-sink  
(See Thermal Considerations)

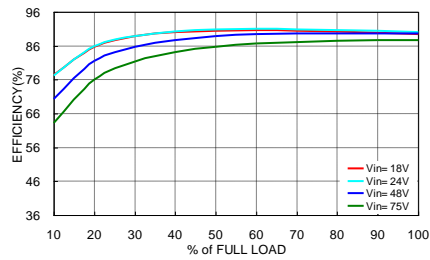

HAE75-48S05W Efficiency vs. Output Load

## FUSE CONSIDERATION

This power module is not internally fused. An input line fuse must always be used.

This encapsulated power module can be used in a wide variety of applications, ranging from simple stand-alone operation to an integrated part of sophisticated power architecture.

To maximum flexibility, internal fusing is not included; however, to achieve maximum safety and system protection, always use an input line fuse.

The input line fuse suggest as below :

Model	Fuse Rating (A)	Fuse Type
HAE75-24S□□W	15	Fast-Blow
HAE75-48S□□W	8	Fast-Blow
HAE75-110S□□W	3.15	Slow-Blow

The table based on the information provided in this data sheet on inrush energy and maximum DC input current at low Vin.

## MECHANICAL DRAWING

### HAE75-24S□□W, HAE75-48S□□W

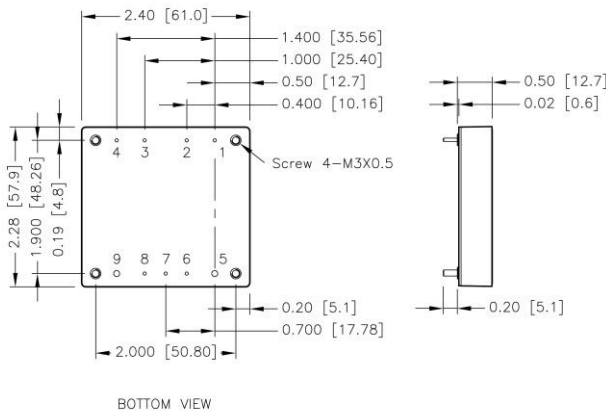

BOTTOM VIEW

- The screw locked torque: MAX 5.0kgf-cm/0.49N-m

### HAE75-110S□□W

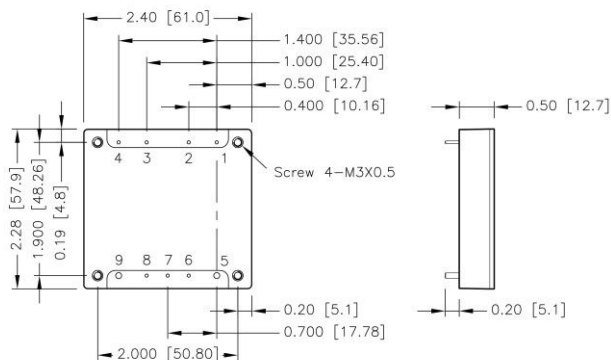

BOTTOM VIEW

- The screw locked torque: MAX 3.5kgf-cm/0.34N-m

### PIN CONNECTION

PIN	DEFINE	DIAMETER
1	-Vin	0.04 Inch
2	Case	0.04 Inch
3	Ctrl	0.04 Inch
4	+Vin	0.04 Inch
5	-Vout	0.08 Inch
6	-Sense	0.04 Inch
7	Trim	0.04 Inch
8	+Sense	0.04 Inch
9	+Vout	0.08 Inch

- All dimensions in inch [mm]
- Tolerance :x.xx±0.02 [x.x±0.5]  
x.xxx±0.01 [x.xx±0.25]
- Pin dimension tolerance ±0.004[0.10]

**TERMINAL BLOCK TYPE OPTION**

**HAE75-□□S□□W -T**

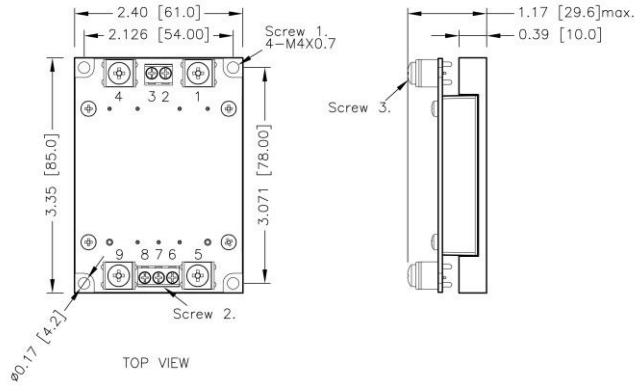

**TERMINAL CONNECTION : -T**

NO.	DEFINE
1	-Vin
2	Case / NC*
3	Ctrl
4	+Vin
5	-Vout
6	-Sense
7	Trim
8	+Sense
9	+Vout

- All dimensions in inch [mm]
- Tolerance :x.xx±0.02 [x.x±0.5]  
x.xxx±0.01 [x.xx±0.25]
- Screw 1 locked torque:  
MAX 11.2kgf-cm/ 1.10N-m
- Screw 2 locked torque:  
MAX 5.2kgf-cm/ 0.51N-m
- Screw 3 locked torque:  
MAX 12.0kgf-cm/ 1.18N-m

**HAE75-□□S□□W -TF1**

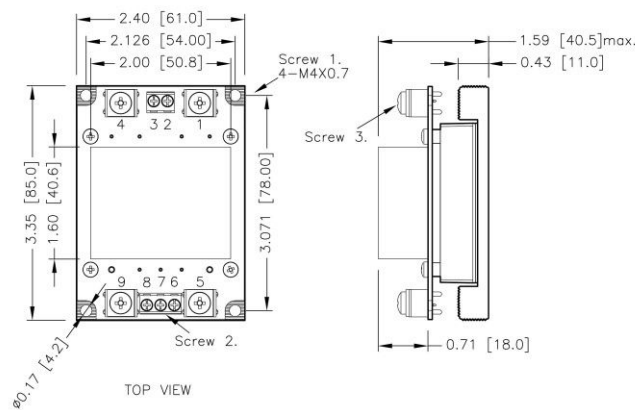

**TERMINAL CONNECTION : -TF1**

NO.	DEFINE
1	-Vin
2	NC
3	Ctrl
4	+Vin
5	-Vout
6	-Sense
7	Trim
8	+Sense
9	+Vout

### RECOMMENDED PAD LAYOUT

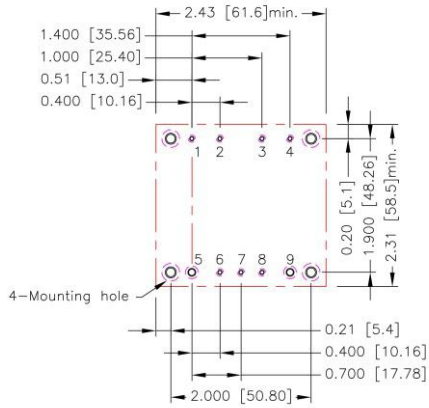

All dimensions in inch[mm]  
 Pad size(lead free recommended)  
 Through hole 1,2,3,4,6,7,8:  $\Phi 0.051[1.30]$   
 Through hole 5,9:  $\Phi 0.091[2.30]$   
 Through hole of mounting:  $\Phi 0.126[3.20]$   
 Top view pad 1,2,3,4,6,7,8:  $\Phi 0.064[1.63]$   
 Top view pad 5,9:  $\Phi 0.113[2.88]$   
 Top view pad of mounting:  $\Phi 0.157[4.00]$   
 Bottom view pad 1,2,3,4,6,7,8:  $\Phi 0.102[2.60]$   
 Bottom view pad 5,9:  $\Phi 0.181[4.60]$   
 Bottom view pad of mounting:  $\Phi 0.252[6.40]$

### THERMAL CONSIDERATIONS

The power module operates in a variety of thermal environments.

However, sufficient cooling should be provided to help ensure reliable operation of the unit.

Heat is removed by conduction, convection, and radiation to the surrounding environment.

Proper cooling can be verified by measuring the point as the figure below.

The temperature at this location should not exceed "Maximum case temperature".

When operating, adequate cooling must be provided to maintain the test point temperature at or below "Maximum case temperature".

You can limit this temperature to a lower value for extremely high reliability.

- Thermal test condition with vertical direction by natural convection (20LFM).
- The Heat-sink is optional and P/N: 7G-0021A-F, 7G-0024A-F, 7GA0127P01-F, 7GA0128P01-F.

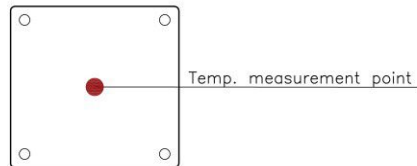

BASE PLATE



## HEAT-SINK TYPE OPTIONS

HAE75-□□S□□W -HS  
7G-0021A-F

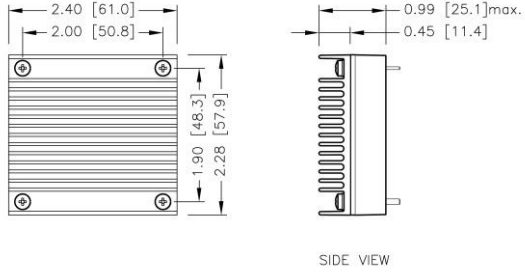

HAE75-□□S□□W -HS3  
7G-0024A-F

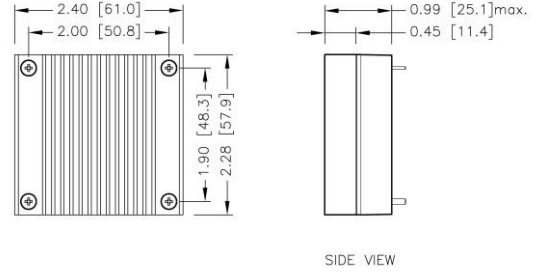

HAE75-□□S□□W -HS4  
7GA0127P01-F

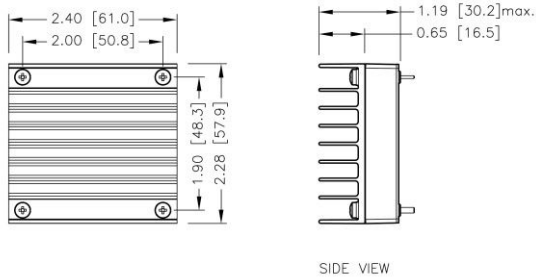

HAE75-□□S□□W -HS5  
7GA0128P01-F

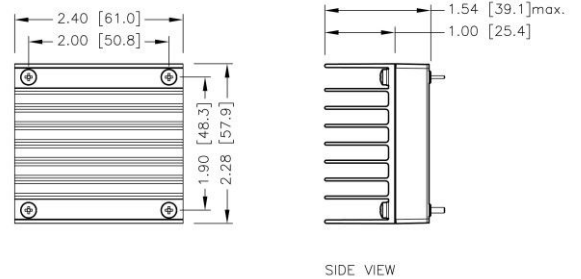

1. All dimensions in inch [mm]
2. Tolerance :x.xx±0.02 [x.x±0.5]  
x.xxx±0.01 [x.xx±0.25]

## OUTPUT VOLTAGE ADJUSTMENT

Output voltage is adjustable for 10% trim up or -20% trim down of nominal output voltage by connecting an external resistor between the Trim pin and either the +Sense or -Sense pins.

With an external resistor between the Trim and -Sense pin, the output voltage set point decreases.

With an external resistor between the Trim and +Sense pin, the output voltage set point increases.

Maximum output deviation is +10% inclusive of remote sense.

The external TRIM resistor needs to be at least 1/8W of rated power.

### Trim Up Equation

$$R_U = \left( \frac{V_{OUT}(100 + \Delta\%) - 100 + 2\Delta\%}{1.225\Delta\%} \right) k\Omega$$

### Trim Down Equation

$$R_D = \left( \frac{100}{\Delta\%} - 2 \right) k\Omega$$

## EXTERNAL OUTPUT TRIMMING

Output can be externally trimmed by using the method shown below.

Trim-up

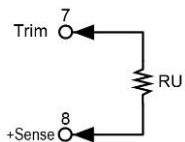

#### □□S3P3W

ΔV (%)	1	2	3	4	5	6	7	8	9	10
Vout (V)	3.333	3.366	3.399	3.432	3.465	3.498	3.531	3.564	3.597	3.630
RU (kΩ)	170.082	85.388	57.156	43.041	34.571	28.925	24.892	21.867	19.515	17.633

#### □□S05W

ΔV (%)	1	2	3	4	5	6	7	8	9	10
Vout (V)	5.05	5.10	5.15	5.20	5.25	5.30	5.35	5.40	5.45	5.50
RU (kΩ)	310.245	156.163	104.803	79.122	63.714	53.442	46.105	40.602	36.322	32.898

#### □□S12W

ΔV (%)	1	2	3	4	5	6	7	8	9	10
Vout (V)	12.12	12.24	12.36	12.48	12.60	12.72	12.84	12.96	13.08	13.20
RU (kΩ)	887.388	447.592	300.993	227.694	183.714	154.395	133.452	117.745	105.528	95.755

#### □□S15W

ΔV (%)	1	2	3	4	5	6	7	8	9	10
Vout (V)	15.15	15.30	15.45	15.60	15.75	15.90	16.05	16.20	16.35	16.50
RU (kΩ)	1134.735	572.490	385.075	291.367	235.143	197.660	170.886	150.806	135.188	122.694

#### □□S24W

ΔV (%)	1	2	3	4	5	6	7	8	9	10
Vout (V)	24.24	24.48	24.72	24.96	25.20	25.44	25.68	25.92	26.16	26.40
RU (kΩ)	1876.776	947.184	637.320	482.388	389.429	327.456	283.190	249.990	224.168	203.510

#### □□S28W

ΔV (%)	1	2	3	4	5	6	7	8	9	10
Vout (V)	28.28	28.56	28.84	29.12	29.40	29.68	29.96	30.24	30.52	30.80
RU (kΩ)	2206.571	1113.714	749.429	567.286	458.000	385.143	333.102	294.071	263.714	239.429

#### □□S48W

ΔV (%)	1	2	3	4	5	6	7	8	9	10
Vout (V)	48.48	48.96	49.44	49.92	50.40	50.88	51.36	51.84	52.32	52.80
RU (kΩ)	3855.551	1946.367	1309.973	991.776	800.857	673.578	582.665	514.480	461.447	419.020

**OUTPUT VOLTAGE ADJUSTMENT(CONTINUED)**

Trim-down

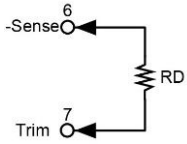

□□S□W

$\Delta V$ (%)	1	2	3	4	5	6	7	8	9	10
RD (k $\Omega$ )	98.000	48.000	31.333	23.000	18.000	14.667	12.286	10.500	9.111	8.000
$\Delta V$ (%)	11	12	13	14	15	16	17	18	19	20
RD (k $\Omega$ )	7.091	6.333	5.692	5.143	4.667	4.250	3.882	3.556	3.263	3.000