



3
YEARS
WARRANTY

ROHS
COMPLIANT

REACH
COMPLIANT



Automation



Datacom



IPC



Industry



Measurement



Telecom



Automobile



Boat



Charger



Medical



PV



Railway



1600
VDC
Isolation
Voltage

2 : 1
Input
Range

6
sided
Shielding

LOW
Standby
Power

NO
Min. Load
Required

REMOTE
ON
OFF

OCP

OTP

OVP

SCP

UVP

PART NUMBER STRUCTURE

LCD30 - **48** **S** **05** - **A** **HC**

Series Name Input Voltage (VDC) Output Quantity Output Voltage (VDC) Remote ON/OFF & Trim Options Assembly Options

12:9~18
24:18~36
48:36~75

S:Single

3P3:3.3
05:5
12:12
15:15
24:24

□:Negative logic
A:Positive logic
B:Without Ctrl pin
C:Negative logic without Trim pin
D:Without Ctrl & Trim pin
E:Positive logic without Trim pin

□: None
HC: 7G-0047C-F; H=0.22" (※NRND)
HC1: 7GA0117P01-F; H=0.3"
HC2: 7GA0118P01-F; H=0.5"
HC3: 7GA0119P01-F; H=0.8"

※NRND: Not recommended for new designs

TECHNICAL SPECIFICATION All specifications are typical at nominal input, full load and 25°C unless otherwise noted

Model Number	Input Range	Output Voltage	Output Current @ Full Load	Input Current @ No Load	Efficiency	Maximum Capacitor Load
	VDC	VDC	mA	mA	%	µF
LCD30-12S3P3	9 ~ 18	3.3	7000	10	87	10000
LCD30-12S05	9 ~ 18	5	6000	10	89	7200
LCD30-12S12	9 ~ 18	12	2500	12	89	1200
LCD30-12S15	9 ~ 18	15	2000	12	89	1000
LCD30-12S24	9 ~ 18	24	1250	12	90	375
LCD30-12D12	9 ~ 18	±12	±1250	12	89	±750
LCD30-12D15	9 ~ 18	±15	±1000	12	90	±500
LCD30-12D24	9 ~ 18	±24	±625	14	90	±180
LCD30-24S3P3	18 ~ 36	3.3	7000	10	87	10000
LCD30-24S05	18 ~ 36	5	6000	10	90	7200
LCD30-24S12	18 ~ 36	12	2500	10	91	1200
LCD30-24S15	18 ~ 36	15	2000	10	91	1000
LCD30-24S24	18 ~ 36	24	1250	10	93	375
LCD30-24D12	18 ~ 36	±12	±1250	10	91	±750
LCD30-24D15	18 ~ 36	±15	±1000	10	91	±500
LCD30-24D24	18 ~ 36	±24	±625	12	92	±180
LCD30-48S3P3	36 ~ 75	3.3	7000	10	88	10000
LCD30-48S05	36 ~ 75	5	6000	10	90	7200
LCD30-48S12	36 ~ 75	12	2500	8	90	1200
LCD30-48S15	36 ~ 75	15	2000	8	91	1000
LCD30-48S24	36 ~ 75	24	1250	8	92	375
LCD30-48D12	36 ~ 75	±12	±1250	8	91	±750
LCD30-48D15	36 ~ 75	±15	±1000	8	92	±500
LCD30-48D24	36 ~ 75	±24	±625	10	92	±180

INPUT SPECIFICATIONS

Parameter	Conditions	Min.	Typ.	Max.	Unit
Operating input voltage range	12Vin(nom)	9	12	18	VDC
	24Vin(nom)	18	24	36	
	48Vin(nom)	36	48	75	
Start up voltage	12Vin(nom)			9	VDC
	24Vin(nom)			18	
	48Vin(nom)			36	
Shutdown voltage	12Vin(nom)	7.5	8	8.8	VDC
	24Vin(nom)	15.5	16	17.5	
	48Vin(nom)	32.5	33	35.5	
Start up time	Constant resistive load	Power up		30	ms
		Remote ON/OFF		30	
Input surge voltage	1 second, max.	12Vin(nom)		25	VDC
		24Vin(nom)		50	
		48Vin(nom)		100	
Input filter				Pi type	
Remote ON/OFF	Referred to -Vin pin	Positive logic	DC-DC ON	Open or 3 ~ 15VDC	
		(Option)	DC-DC OFF	Short or 0 ~ 1.2VDC	
		Negative logic	DC-DC ON	Short or 0 ~ 1.2VDC	
		(Standard)	DC-DC OFF	Open or 3 ~ 15VDC	
		Input current of Ctrl pin		-0.5	1.0
Remote off input current			2.0	mA	

OUTPUT SPECIFICATIONS							
Parameter	Conditions		Min.	Typ.	Max.	Unit	
Voltage accuracy			-1.0		+1.0	%	
Line regulation	Low Line to High Line at Full Load	Single	-0.2		+0.2	%	
		Dual	-0.5		+0.5		
Load regulation	No Load to Full Load	Single	-0.2		+0.2	%	
		Dual	-1.0		+1.0		
	10% Load to 90%Load	Single	-0.1		+0.1		
		Dual	-0.8		+0.8		
Cross regulation	Asymmetrical load 25%/100% FL	Dual	-5.0		+5.0	%	
Voltage adjustability	Single output	15Vout, 24Vout	-10		+20	%	
		Others	-10		+10		
Ripple and noise	Measured by 20MHz bandwidth					mVp-p	
	With a 22 μ F/25V X7R MLCC	Single					
		3.3Vout, 5Vout	75				
		12Vout, 15Vout	75				
	With 2 pcs of 22 μ F/25V X7R MLCC	Dual	24Vout	75			
			With a 10 μ F/25V X7R MLCC for each output	12Vout, 15Vout	60		
24Vout				75			
With 2 pcs of 6.8 μ F/50V X7R MLCC	Dual	12Vout, 15Vout	60				
		24Vout	75				
Temperature coefficient			-0.02		+0.02	%/°C	
Transient response recovery time	25% load step change					250	μ s
Over voltage protection			3.7		5.4	VDC	
			5.6		7.0		
			13.5		19.6		
			18.3		22.0		
			29.1		32.5		
Over load protection	% of Iout rated; Hiccup mode					140	%
Short circuit protection						Continuous, automatic recovery	

GENERAL SPECIFICATIONS						
Parameter	Conditions		Min.	Typ.	Max.	Unit
Isolation voltage	1 minute	Input to Output	1600			VDC
		Input(Output) to Case	1000			
Isolation resistance	500VDC					G Ω
Isolation capacitance					1500	pF
Switching frequency		3.3Vout, 5Vout	248	275	303	kHz
		Others	297	330	363	
Safety approvals	IEC/ EN/ UL62368-1					UL:E193009 CB:UL(Demko)
Case material						Copper
Base material						FR4 PCB
Potting material						Silicone (UL94 V-0)
Weight						16.5g (0.58oz)
MTBF	MIL-HDBK-217F, Full load					1.303 x 10 ⁶ hrs

ENVIRONMENTAL SPECIFICATIONS					
Parameter	Conditions		Min.	Typ.	Max. Unit
Operating ambient temperature	Without derating		-40		+50 °C
	With derating		+50		+100 °C
Maximum case temperature					105 °C
Over temperature protection				115	°C
Storage temperature range			-55		+125 °C
Thermal impedance	Natural convection	Without Heat-sink		15.0	°C/W
		With Heat-sink	HC	13.8	
			HC1	11.1	
			HC2	9.6	
			HC3	8.2	
Thermal shock					MIL-STD-810F
Vibration					MIL-STD-810F
Relative humidity					5% to 95% RH

EMC SPECIFICATIONS			
Parameter	Conditions		Level
EMI	EN55032	With external components.	Class A, Class B
EMS	EN55035		
ESD	EN61000-4-2	Air ± 8kV and Contact ± 6kV	Perf. Criteria A
Radiated immunity	EN61000-4-3	10 V/m	Perf. Criteria A
Fast transient	EN61000-4-4	± 2kV	Perf. Criteria A
	LCD30-12□□□	With an aluminum electrolytic capacitor (Nippon chemi-con KY series, 220μF/100V) and a TVS (SMDJ58A, 58V, 3000Watt peak pulse power) in parallel.	
	LCD30-24□□□	With an aluminum electrolytic capacitor (Nippon chemi-con KY series, 220μF/100V).	
	LCD30-48□□□	With an aluminum electrolytic capacitor (Nippon chemi-con KY series, 220μF/100V).	
Surge	EN61000-4-5	± 2kV	Perf. Criteria A
	LCD30-12□□□	With an aluminum electrolytic capacitor (Nippon chemi-con KY series, 220μF/100V) and a TVS (SMDJ58A, 58V, 3000Watt peak pulse power) in parallel.	
	LCD30-24□□□ LCD30-48□□□	With an aluminum electrolytic capacitor (Nippon chemi-con KY series, 220μF/100V).	
Conducted immunity	EN61000-4-6	10 Vr.m.s	Perf. Criteria A
Power frequency magnetic field	EN61000-4-8	100A/m continuous; 1000A/m 1 second	Perf. Criteria A

CAUTION: This power module is not internally fused. An input line fuse must always be used.

CHARACTERISTIC CURVE

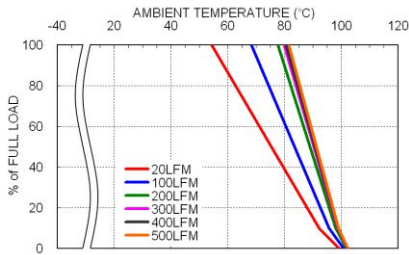

LCD30-48S05 Derating Curve

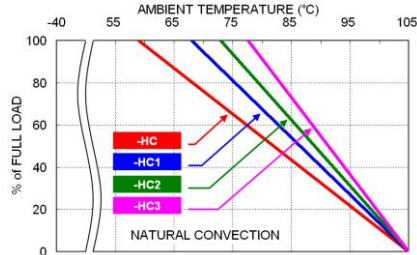

LCD30-48S05 Derating Curve With Heat-sink

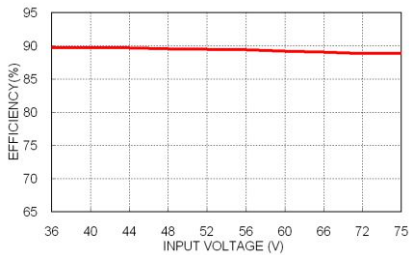

LCD30-48S05 Efficiency vs. Input Voltage

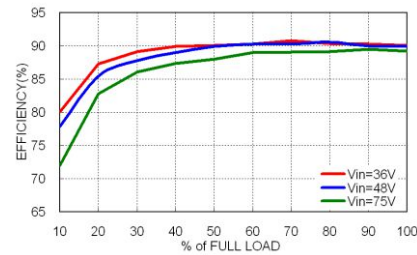

LCD30-48S05 Efficiency vs. Output Load

FUSE CONSIDERATION

This power module is not internally fused. An input line fuse must always be used.

This encapsulated power module can be used in a wide variety of applications, ranging from simple stand-alone operation to an integrated part of sophisticated power architecture.

To maximum flexibility, internal fusing is not included; however, to achieve maximum safety and system protection, always use an input line fuse.

The input line fuse suggest as below :

Model	Fuse Rating (A)	Fuse Type
LCD30-12S□□ · LCD30-12D□□	6	Slow-Blow
LCD30-24S□□ · LCD30-24D□□	3	Slow-Blow
LCD30-48S□□ · LCD30-48D□□	2	Slow-Blow

The table based on the information provided in this data sheet on inrush energy and maximum DC input current at low Vin.

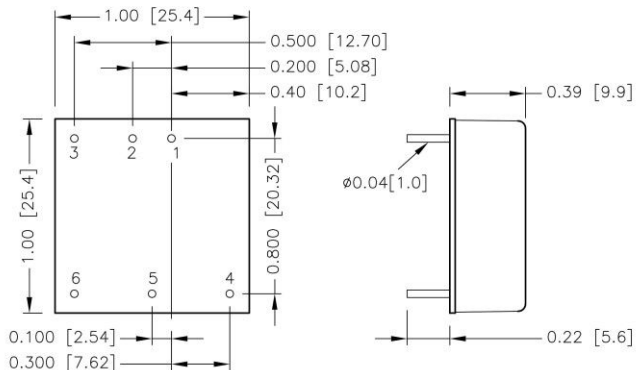
MECHANICAL DRAWING

BOTTOM VIEW

PIN CONNECTION

PIN	SINGLE	DUAL
1	+Vin	+Vin
2	-Vin	-Vin
3	Ctrl	Ctrl
4	+Vout	+Vout
5	Trim	Common
6	-Vout	-Vout

1. All dimensions in inch [mm]
2. Tolerance :x.xx±0.02 [x.xx±0.5]
x.xxx±0.01 [x.xx±0.25]
3. Pin pitch tolerance ±0.01 [0.25]
4. Pin dimension tolerance ±0.004[0.10]

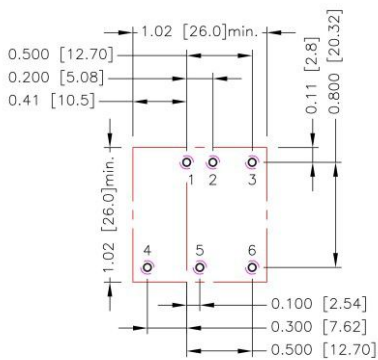
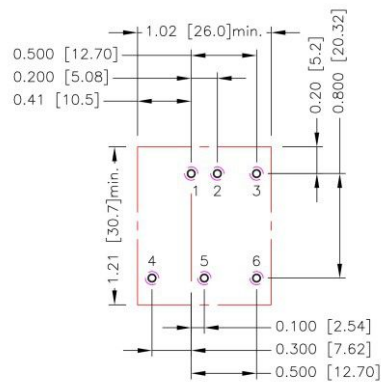
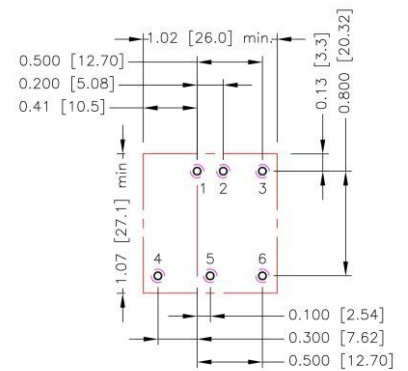
RECOMMENDED PAD LAYOUT
Standard

-HC

-HC1 、 -HC2 、 -HC3

All dimensions in inch[mm]
 Pad size(lead free recommended)
 Through hole 1.2.3.4.5.6: $\phi 0.051 [1.30]$
 Top view pad 1.2.3.4.5.6: $\phi 0.064 [1.63]$
 Bottom view pad 1.2.3.4.5.6: $\phi 0.102 [2.60]$

THERMAL CONSIDERATIONS

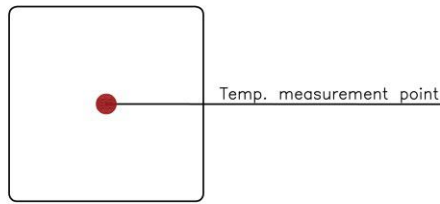
The power module operates in a variety of thermal environments. However, sufficient cooling should be provided to help ensure reliable operation of the unit. Heat is removed by conduction, convection, and radiation to the surrounding environment. Proper cooling can be verified by measuring the point as the figure below. The temperature at this location should not exceed "Maximum case temperature". When operating, adequate cooling must be provided to maintain the test point temperature at or below "Maximum case temperature". You can limit this temperature to a lower value for extremely high reliability.

- Thermal test condition with vertical direction by natural convection (20LFM).



TOP VIEW

HEAT-SINK OPTIONS

LCD30-□□□□□W-**HC**
7G-0047C-F

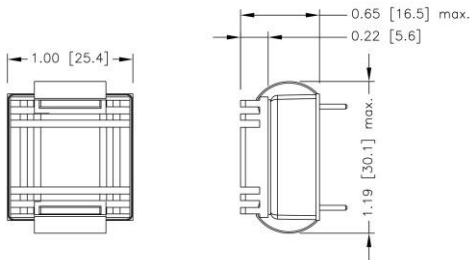

SIDE VIEW

LCD30-□□□□□-**HC1**
7GA0117P01-F

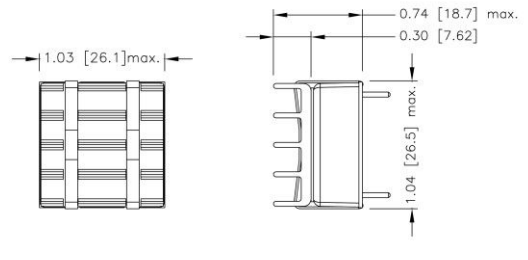

SIDE VIEW

LCD30-□□□□□-**HC2**
7GA0118P01-F

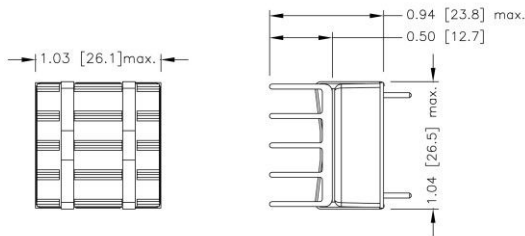

SIDE VIEW

LCD30-□□□□□-**HC3**
7GA0119P01-F

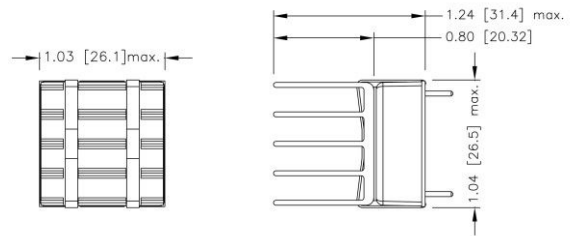

SIDE VIEW

- All dimensions in inch [mm]
- Tolerance :x.xx±0.02 [x.x±0.5]
x.xxx±0.010 [x.xx±0.25]

OUTPUT VOLTAGE ADJUSTMENT

Output voltage set point adjustment allows the user to increase or decrease the output voltage set point of the module. This is accomplished by connecting an external resistor between the Trim pin and either the +Output or -Output pins. With an external resistor between the Trim and -Output pin, the output voltage set point increases. With an external resistor between the Trim and +Output pin, the output voltage set point decreases. The external Trim resistor needs to be at least 1/16W of rated power.

Trim Up Equation

$$R_U = \left[\frac{G \times L}{(V_{o,up} - L - K)} - H \right] \Omega$$

Trim Down Equation

$$R_D = \left[\frac{(V_{o,down} - L) \times G}{(V_o - V_{o,down})} - H \right] \Omega$$

Trim constants

Module	G	H	K	L
LCD30-□□S3P3	5110	2050	0.8	2.5
LCD30-□□S05	5110	2050	2.5	2.5
LCD30-□□S12	10000	5110	9.5	2.5
LCD30-□□S15	10000	5110	12.5	2.5
LCD30-□□S24	56000	13000	21.5	2.5

EXTERNAL OUTPUT TRIMMING

Output can be externally trimmed by using the method shown below.

Trim-up

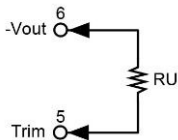

□□S3P3

ΔV (%)	1	2	3	4	5	6	7	8	9	10
Vout (V)	3.333	3.366	3.399	3.432	3.465	3.498	3.531	3.564	3.597	3.630
RU (kΩ)	385.071	191.511	126.990	94.730	75.374	62.470	53.253	46.340	40.963	36.662

□□S05

ΔV (%)	1	2	3	4	5	6	7	8	9	10
Vout (V)	5.050	5.100	5.150	5.200	5.250	5.300	5.350	5.400	5.450	5.500
RU (kΩ)	253.450	125.700	83.117	61.825	49.050	40.533	34.450	29.888	26.339	23.500

□□S12

ΔV (%)	1	2	3	4	5	6	7	8	9	10
Vout (V)	12.120	12.240	12.360	12.480	12.600	12.720	12.840	12.960	13.080	13.200
RU (kΩ)	203.223	99.057	64.334	46.973	36.557	29.612	24.652	20.932	18.038	15.723

□□S15

ΔV (%)	1	2	3	4	5	6	7	8	9	10
Vout (V)	15.150	15.300	15.450	15.600	15.750	15.900	16.050	16.200	16.350	16.500
RU (kΩ)	161.557	78.223	50.446	36.557	28.223	22.668	18.700	15.723	13.409	11.557
ΔV (%)	11	12	13	14	15	16	17	18	19	20
Vout (V)	16.650	16.800	16.950	17.100	17.250	17.400	17.550	17.700	17.850	18.000
RU (kΩ)	10.042	8.779	7.711	6.795	6.001	5.307	4.694	4.149	3.662	3.223

□□S24

ΔV (%)	1	2	3	4	5	6	7	8	9	10
Vout (V)	24.240	24.480	24.720	24.960	25.200	25.440	25.680	25.920	26.160	26.400
RU (kΩ)	570.333	278.667	181.444	132.833	103.667	84.222	70.333	59.917	51.815	45.333
ΔV (%)	11	12	13	14	15	16	17	18	19	20
Vout (V)	26.640	26.880	27.120	27.360	27.600	27.840	28.080	28.320	28.560	28.800
RU (kΩ)	40.030	35.611	31.872	28.667	25.889	23.458	21.314	19.407	17.702	16.167

OUTPUT VOLTAGE ADJUSTMENT(CONTINUED)

Trim-down

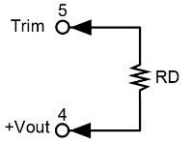
□□S3P3

ΔV (%)	1	2	3	4	5	6	7	8	9	10
Vout (V)	3.267	3.234	3.201	3.168	3.135	3.102	3.069	3.036	3.003	2.970
RD (k Ω)	116.719	54.779	34.133	23.810	17.616	13.486	10.537	8.325	6.604	5.228

□□S05

ΔV (%)	1	2	3	4	5	6	7	8	9	10
Vout (V)	4.950	4.900	4.850	4.800	4.750	4.700	4.650	4.600	4.550	4.500
RD (k Ω)	248.340	120.590	78.007	56.715	43.940	35.423	29.340	24.778	21.229	18.390

□□S12

ΔV (%)	1	2	3	4	5	6	7	8	9	10
Vout (V)	11.880	11.760	11.640	11.520	11.400	11.280	11.160	11.040	10.920	10.800
RD (k Ω)	776.557	380.723	248.779	182.807	143.223	116.834	97.985	83.848	72.853	64.057

□□S15

ΔV (%)	1	2	3	4	5	6	7	8	9	10
Vout (V)	14.850	14.700	14.550	14.400	14.250	14.100	13.950	13.800	13.650	13.500
RD (k Ω)	818.223	401.557	262.668	193.223	151.557	123.779	103.938	89.057	77.483	68.223

□□S24

ΔV (%)	1	2	3	4	5	6	7	8	9	10
Vout (V)	23.760	23.520	23.280	23.040	22.800	22.560	22.320	22.080	21.840	21.600
RD (k Ω)	4947.667	2439.333	1603.222	1185.167	934.333	767.111	647.667	558.083	488.407	432.667