

Mounting Option

02-.128 (3.25) Dia. Mounting Holes

Contact Detail

500-Wire Hole .087x.013(2.21x0.33) - Tail LG.=.282(7.16)
 .156 [3.96] Contact Spacing x .140 [3.56] Row Spacing

THIS IS A C.A.D. GENERATED DRAWING
 DO NOT MAKE MANUAL REVISIONS TO MASTER.



ISSUE NUMBER

ORIGINAL

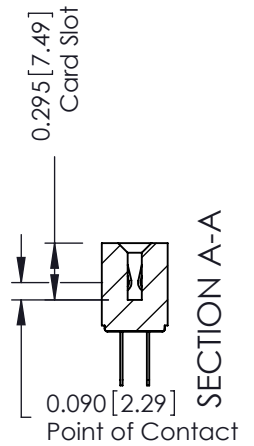
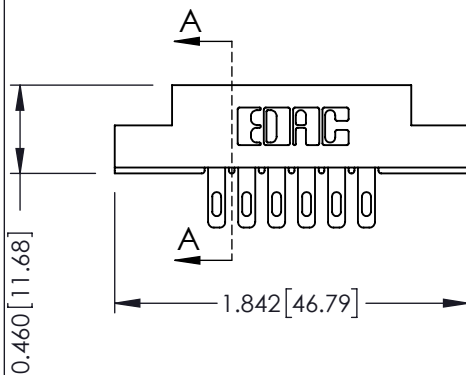
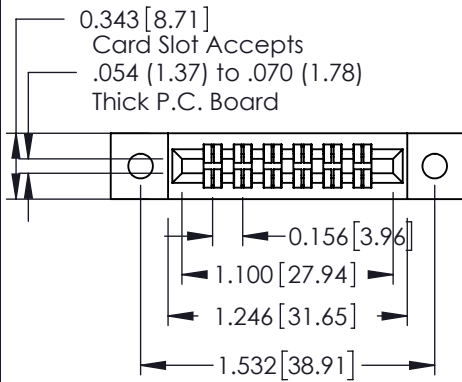

See Accompanying Page for:
 • Mounting Options

305 / 315 / 355 Card Edge Connector

Part Number: 355-012-500-202



EDAC INC
 TORONTO, ONTARIO
 CANADA

YOUR CONNECTION TO QUALITY & SERVICE

THESE DRAWINGS AND SPECIFICATIONS
 ARE THE PROPERTY OF EDAC INC. AND
 SHALL NOT BE REPRODUCED, OR COPIED
 OR USED AS THE BASIS FOR THE
 MANUFACTURE OR SALE OF APPARATUS
 WITHOUT WRITTEN PERMISSION.

ACAD REFERENCE NO. 305 ENG MASTER

DRAWN: J.LEE DATE: SEPT. 21/09

CHECKED: DATE:

SCALE: NTS SHEET 1 OF 2

DRAWING NUMBER 305 Assembly ISSUE 1

THIS IS A C.A.D. GENERATED DRAWING
DO NOT MAKE MANUAL REVISIONS TO MASTER.



ISSUE NUMBER

ORIGINAL



305 / 315 / 355 Card Edge Connector Mounting Options		ACAD REFERENCE NO. 305 ENG MASTER	
		DRAWN: J.LEE	DATE: SEPT. 21/09
 EDAC INC TORONTO, ONTARIO CANADA YOUR CONNECTION TO QUALITY & SERVICE		CHECKED: DATE:	
		SCALE: NTS	
THESE DRAWINGS AND SPECIFICATIONS ARE THE PROPERTY OF EDAC INC. AND SHALL NOT BE REPRODUCED, OR COPIED OR USED AS THE BASIS FOR THE MANUFACTURE OR SALE OF APPARATUS WITHOUT WRITTEN PERMISSION.		DRAWING NUMBER	
		305 Assembly	