

**Order Number
203702-6400**

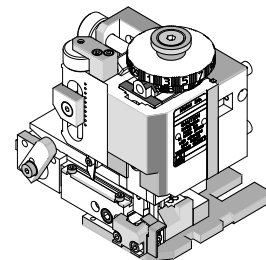

Application Tooling Specification



FEATURES

- Quick punch removal with the push of a button for fast and easy tooling change
- Applicator designed to industry-standard mounting and 135.80mm (5.346") shut height
- Quick setup time; plus, the crimp height, track and feed adjustments can be set without removing the applicator from the press
- Fine adjustment allows users to achieve target with little effort by adjusting in increments of 0.15mm (.0006") for conductor crimp height and .063mm (.0025") for insulation height
- Independent adjustment rings allow users to quickly adjust the conductor or insulation crimp height without affecting each other
- This tool is IPC/WHMA-A-620 Class 2 Compliant, as indicated below
- Directly adapts to most automatic wire processing machines
- For 26-28AWG Micro-One terminals, use applicator 203702-6000

SCOPE

Products: Micro-One Wire-to-Board Receptacle Terminal, 22-24 AWG (UL1007) wires.

Terminal Series No.	Terminal Order No.	Wire Size		Insulation Diameter				Strip Length	
				IPC/WHMA-A-620 (1)		Terminal (2)			
		AWG	Wire Type	mm	In.	mm	In.	mm	In.
56134	56134-9001	22-24	UL1007	1.27-1.70	.050-.067	1.70 max	.067 max	1.60-2.00	.063-.078

(1) To achieve optimum IPC/WHMA-A-620 insulation crimps, use this insulation OD range.
 (2) Overall insulation OD specification for terminal.

DEFINITION OF TERMS

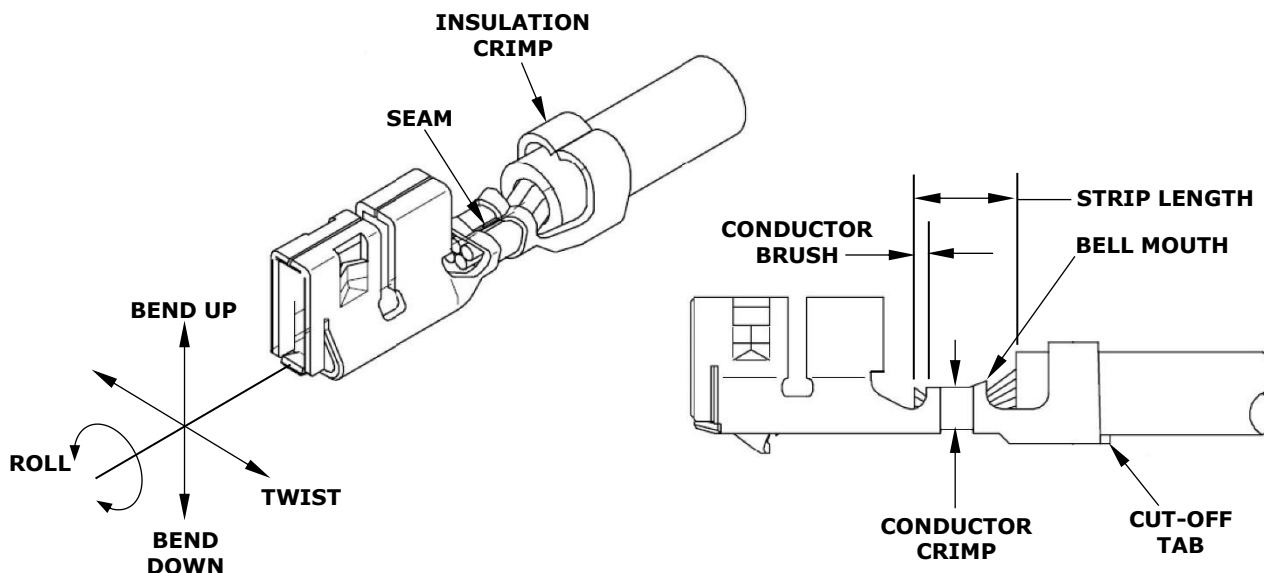

CRIMP SPECIFICATION

Terminal Series No.	Bell Mouth		Cut-Off Tab Maximum		Conductor Brush	
	mm	In.	mm	In.	mm	In.
56134	0.05-0.40	.002-.016	0.30	.012	0.10-0.70	.004-.028

Terminal Series No.	Bend Up	Bend Down	Twist	Roll	Punch Width (Ref)				Seam
					Conductor		Insulation		
	Degree (Max)	Degree (Max)	mm	In.	mm	In.			
56134	3	3	3	6	1.15	.045	1.50	.059	Seam shall not be open and no wire allowed out of the crimping area

After crimping, the conductor profile should measure the following:

Terminal Series No.	Wire Size	Conductor Crimp Height		Insulation Crimp Height (Ref)		Pull Force Minimum	
	AWG	mm	In.	mm	In.	N	Lb.
56134	22	0.71-0.76	.028-.030	1.85	.073	44.1	9.9
	24	0.62-0.67	.024-.026	1.72	.068	29.4	6.6

Tool Qualification Notes

1. Pull force should be measured with no influence from the insulation crimp.
2. The above specifications are guidelines to an optimum crimp.
3. Terminal Oiler (63801-7240) will improve tooling life and minimize crimp extrusions. See 63800-4900 FineAdjust manual.

PARTS LIST

FineAdjust Applicator 203702-6400				
Item	Order No.	Engineering No.	Description	Quantity
Perishable Tooling				
	203702-6470	203702-6470	Tool Kit (All "Y" Items)	REF
1	63457-1150	63457-1150	Conductor Punch	1 Y
2	63455-1150	63455-1150	Conductor Anvil	1 Y
3	63454-1501	63454-1501	Insulation Punch	1 Y
4	63456-1501	63456-1501	Insulation Anvil	1 Y
5	63443-0005	63443-0005	Cut-Off Plunger	1 Y
6	63443-0012	63443-0012	Front Plunger Retainer	1 Y
Other Components				
7	63600-5820	63600-5820	Nose Hold Down	1
8	11-18-4083	60707-8	Feed Guide	1
9	11-24-1067	4996-4	Cut-Off Plunger Spring	1
10	63443-0009	63443-0009	Front Scrap Chute	1
11	63443-0024	63443-0024	Key	1
12	63443-0090	63443-0090	Wire Stop	1
13	63443-7401	63443-7401	Terminal Hold Down Mount	1
14	63443-7549	63443-7549	Anvil Mount	1
15	63443-2806	63443-2806	Front Plunger Striker	1
16	63443-2906	63443-2906	Wire Hold Down Plunger	1
17	63443-6110	63443-6110	Rear Cover	1
18	63600-0021	63600-0021	Compression Spring	1
Frame				
19	63800-4901	63800-4901	Top	1
20	63801-3281	63801-3281	Base	1
21	63801-4650	63801-4650	Track	1
Hardware				
22	—	—	M3 by 4 long brass-tip SSS	1*
23	—	—	M3 by 6 Long SHCS	2*
24	—	—	M3 by 6 Long FHCS	1*
25	—	—	M4 by 6 Long SHCS	2*
26	—	—	M4 by 10 Long SHCS	1*
27	—	—	M4 by 12 Long BHCS	2*
28	—	—	M4 by 45 Long SHCS	2*
29	—	—	M5 by 12 Long SHCS	1*
30	—	—	#10-32 by 3/8" Long Flat Point SSS	1*
31	—	—	#10-32 Hex Jam Nut	1*

* Available from an industrial supply company.

ASSEMBLY DRAWING

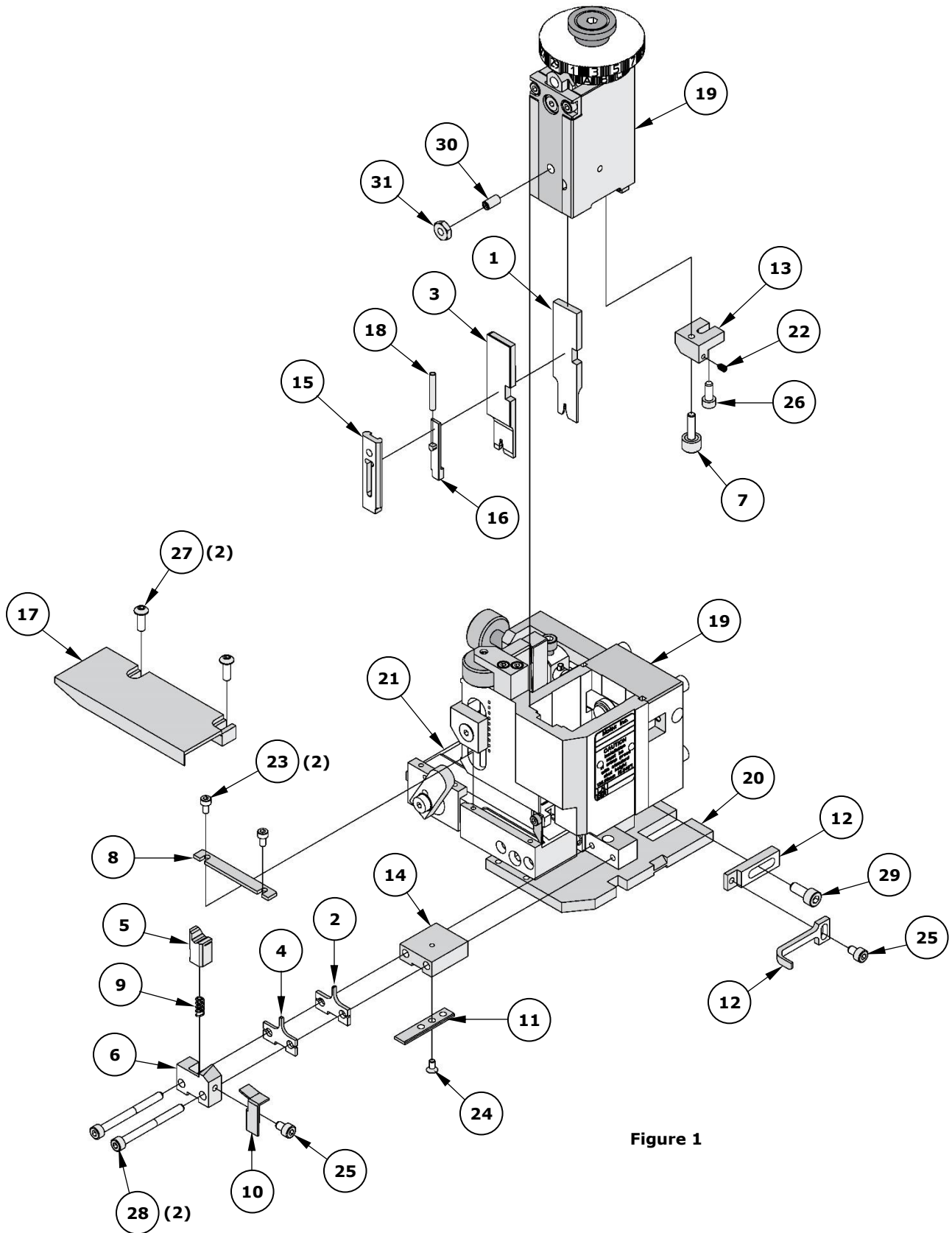

Figure 1

NOTES

1. Molex recommends that an extra perishable tooling kit be maintained at your facility.
2. Verify tooling alignment by manually cycling the press and applicator before crimping under power. Check that all screws are tight.
3. Slugs, terminals, dirt and oil should be kept clear of the work area.
4. Wear safety glasses at all times.
5. For recommended maintenance, refer to the FineAdjust manual.

CAUTION: This applicator should only be used in a press with a shut height of 135.8mm (5.346"). Tooling damage could result at a lower setting.

CAUTION: To prevent injury, never operate this applicator without the guards supplied with the press or wire-processing machine in place. Reference the press or wire processing manufacturer's instruction manual.

CAUTION: Molex crimp specifications are valid only when used with Molex terminals, applicators and tooling.

Application Tooling Support

Phone: (402) 458-TOOL (8665)

E-Mail: applicationtooling@molex.com

Website: www.molex.com/applicationtooling

Molex is a registered trademark of Molex, LLC in the United States of America and may be registered in other countries; all other trademarks listed herein belong to their respective owners.