

BASE CAGE DETAILS

(APPLIES TO ALL CAGES IN THIS DRAWING)

747540420

SHOWN

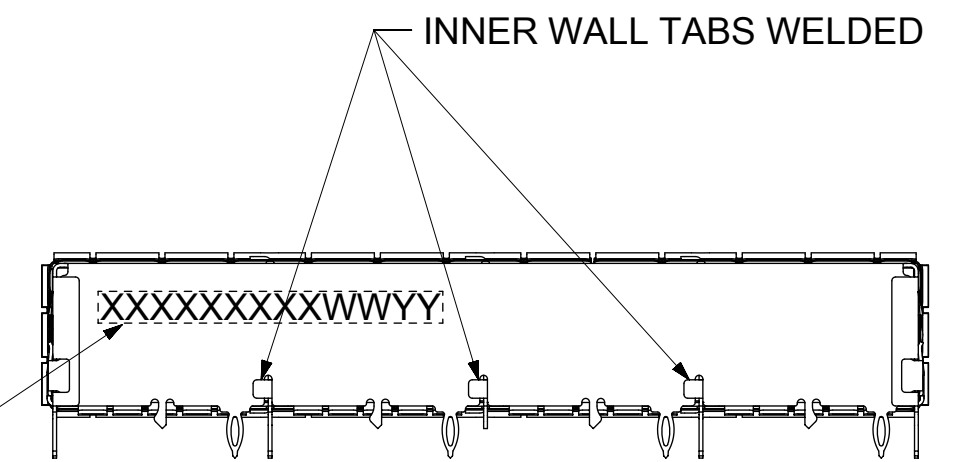
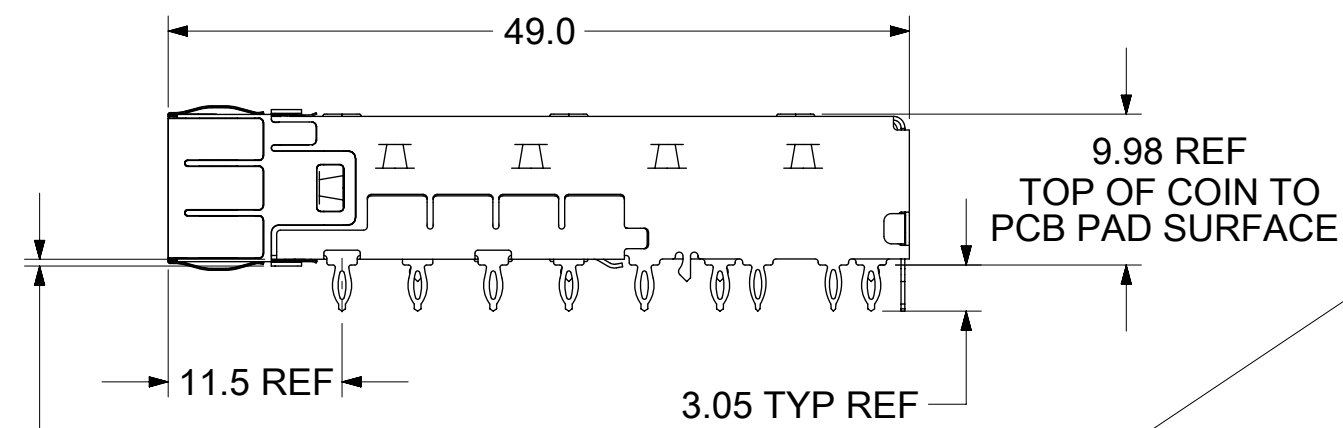
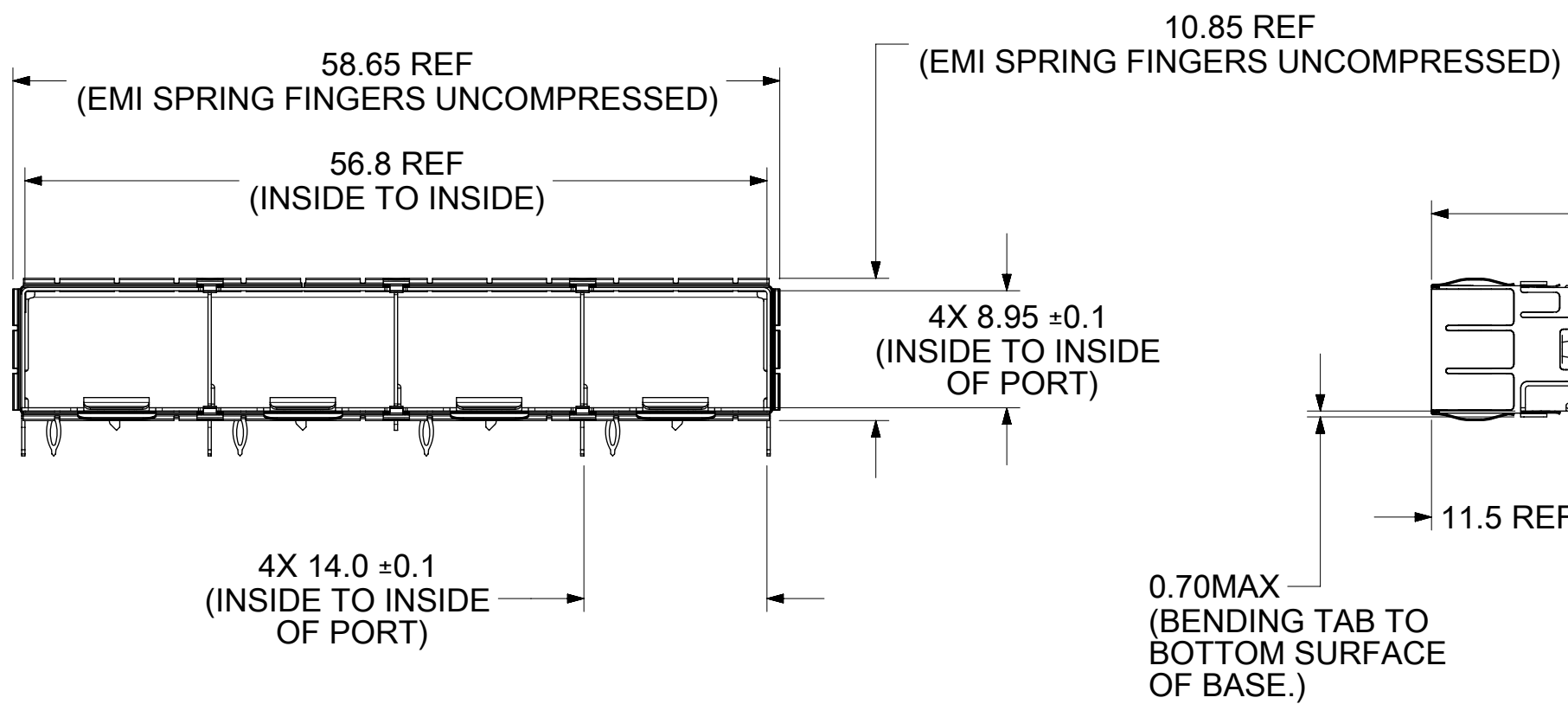
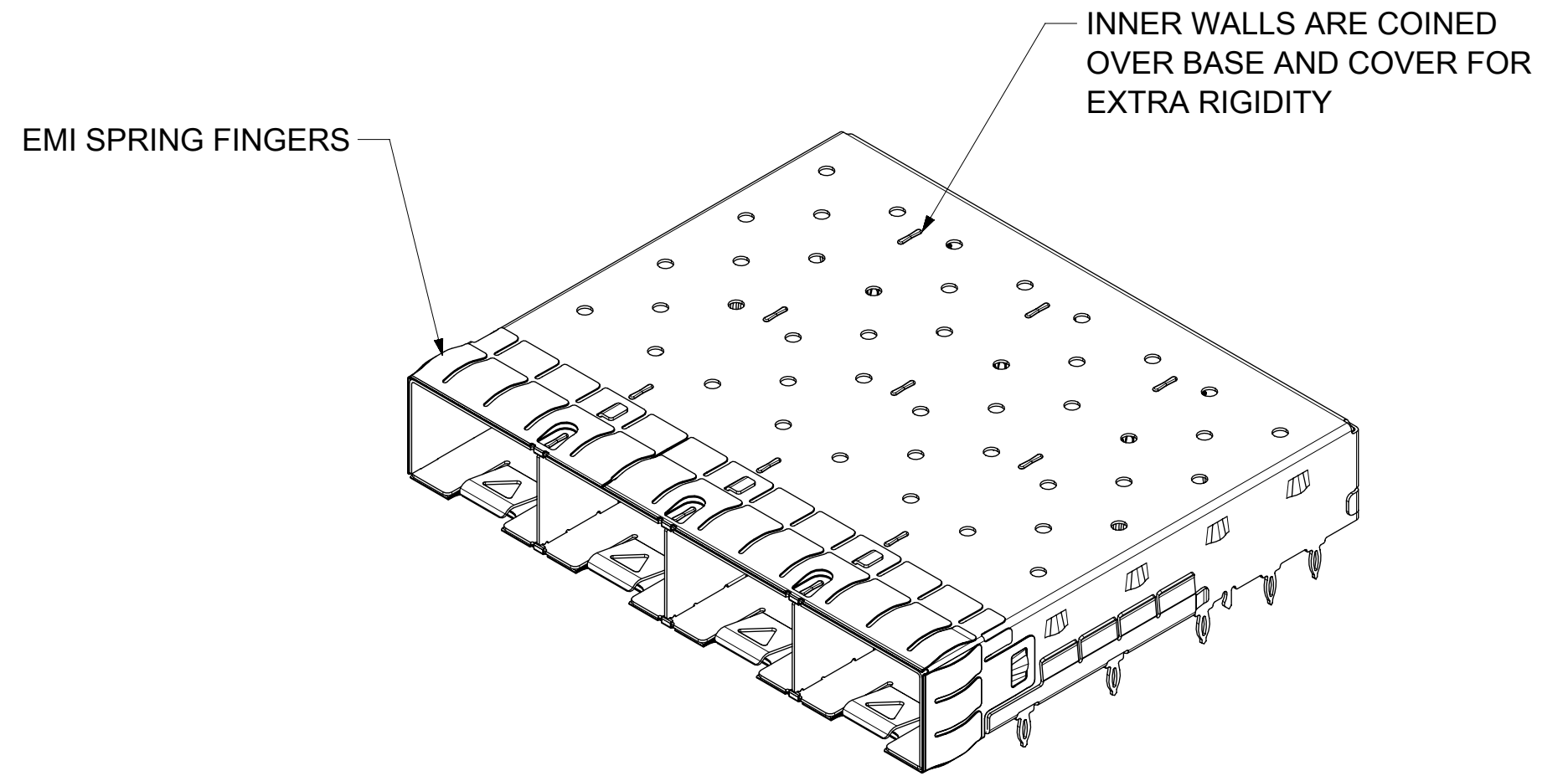
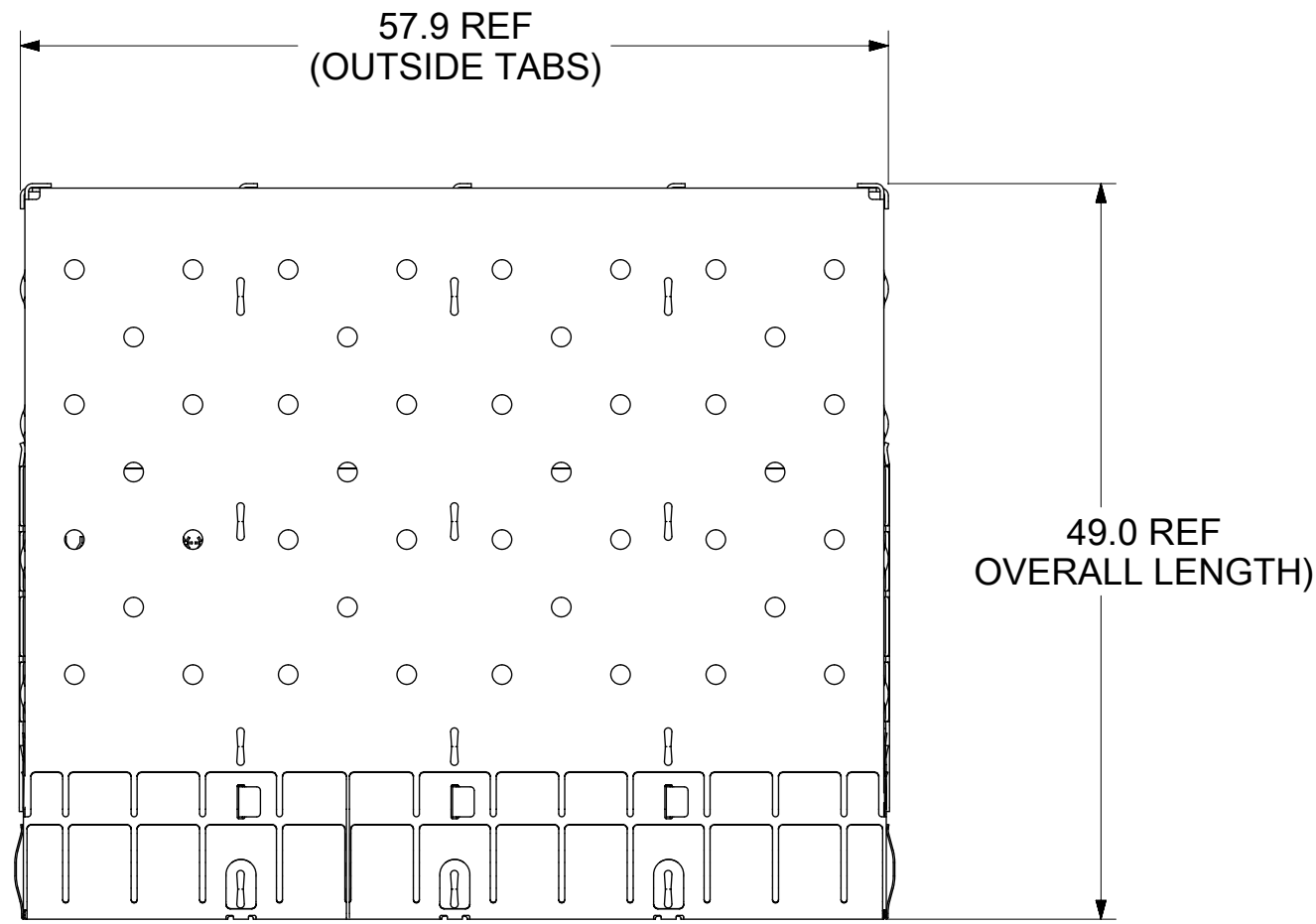

PART NO. AND WEEK/YEAR DATE CODE TO BE PRINTED ON THE BACK OF COMPLETED CAGE ASSEMBLY APPROXIMATELY AS SHOWN ON 74754 SERIES CAGE ASSEMBLIES.

NOTES:

- MATERIAL:**
CAGE: 0.25mm THICK COPPER ALLOY, NICKEL PLATED.
SPRING FINGERS: 0.10mm THICK COPPER ALLOY, NICKEL PLATED.
HEATSINK: ALUMINUM, NICKEL PLATED.
HEATSINK SPRING CLIP: STAINLESS STEEL.
- PRESS FIT LEGS 3.05mm LONG:**
- PORTS ARE DESIGNED FOR SFP+ TRANSCEIVERS AND ARE COMPATIBLE WITH SFP TRANSCEIVERS.**
THE TOP SURFACE OF THE MODULE MUST BE FLAT (NO PRODUCT LABEL RECESS)
AND THERMALLY CONDUCTIVE TO FUNCTION OPTIMALLY.
- WELD SPOT MAY SHOW SLIGHT MATERIAL DISCOLORATION.**
- NO RoHS EXEMPTIONS.**
- CUSTOM HEATSINKS AVAILABLE UPON REQUEST.**

WEEK/YEAR DATE CODE TABLE	
WW	01 THRU 52 OR 53 EXAMPLE: 01 = FIRST WEEK OF YEAR 52 = LAST WEEK OF YEAR
YY	19, 20, 21,,, ETC. EXAMPLE: YEAR 2019 = 19

THIS DRAWING CONTAINS INFORMATION THAT IS PROPRIETARY TO MOLEX ELECTRONIC TECHNOLOGIES, LLC AND SHOULD NOT BE USED WITHOUT WRITTEN PERMISSION									
DIMENSION UNITS	SCALE	CURRENT REV DESC: OBSOLETE PART NUMBERS AS PER PCN#509457.							
mm	2:1								
GENERAL TOLERANCES (UNLESS SPECIFIED)		EC NO: 680890			SFP+ 1X4 SF CAGE 3.05 MM PRESS FIT, HEAT SINKS, WITH EMI SPRING FINGERS				
ANGULAR TOL	± 1.0°	DRWN: ASYAMIKAR 2020/01/16			PRODUCT CUSTOMER DRAWING				
4 PLACES	±	CHK'D: GGA 2021/11/25			DOCUMENT NUMBER				
3 PLACES	±	APPR: GGA 2021/11/25			111122420				
2 PLACES	± 0.15	INITIAL REVISION:			DOC TYPE DOC PART REVISION				
1 PLACE	± 0.25	DRWN: VK10 2016/06/02			PSD ASY M2				
0 PLACES	±	APPR: RCHEN08 2016/08/04			MATERIAL NUMBER CUSTOMER SHEET NUMBER				
DRAFT WHERE APPLICABLE MUST REMAIN WITHIN DIMENSIONS		THIRD ANGLE PROJECTION	DRAWING	SERIES	SEE SHEET 3		1 OF 8		

DOCUMENT STATUS	P1	RELEASE DATE	2021/11/25 12:19:23
-----------------	----	--------------	---------------------

CAGE ASSEMBLY OPTIONS

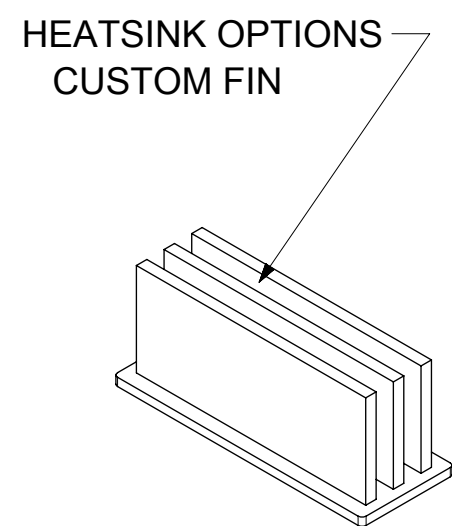
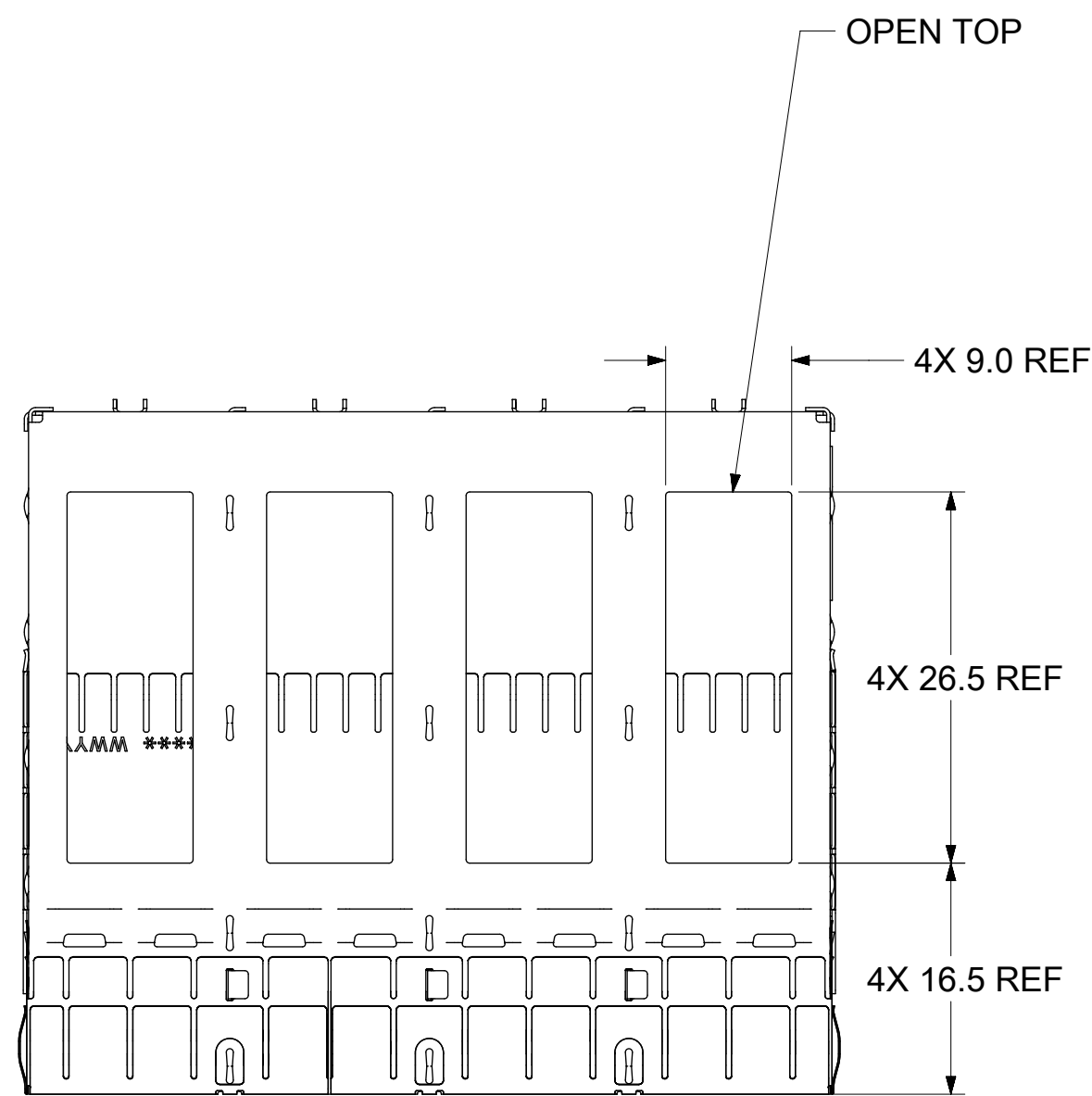

OVERALL HEATSINK HEIGHT

APPLICATION	DIM 'A'
CUSTOM	23.6

HEATSINK OPTIONS

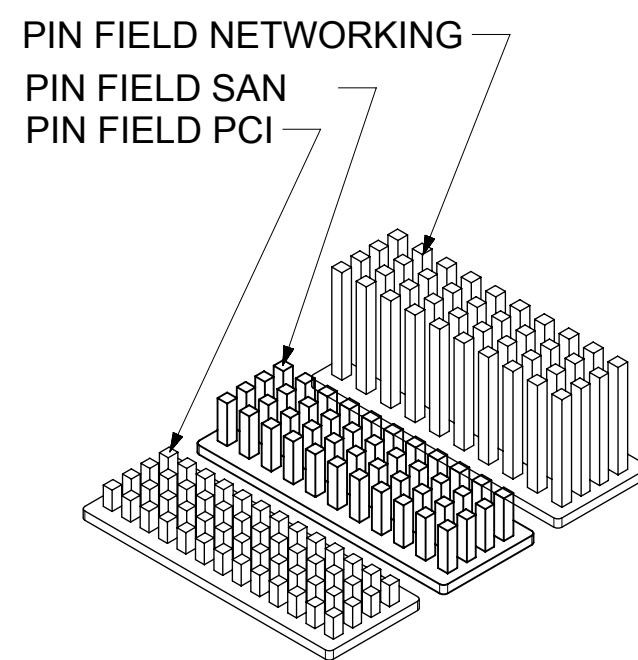

OVERALL HEATSINK HEIGHT

APPLICATION	DIM 'A'
PCI	14.3
SAN	16.6
NETWORKING	23.6

HEATSINK OPTIONS

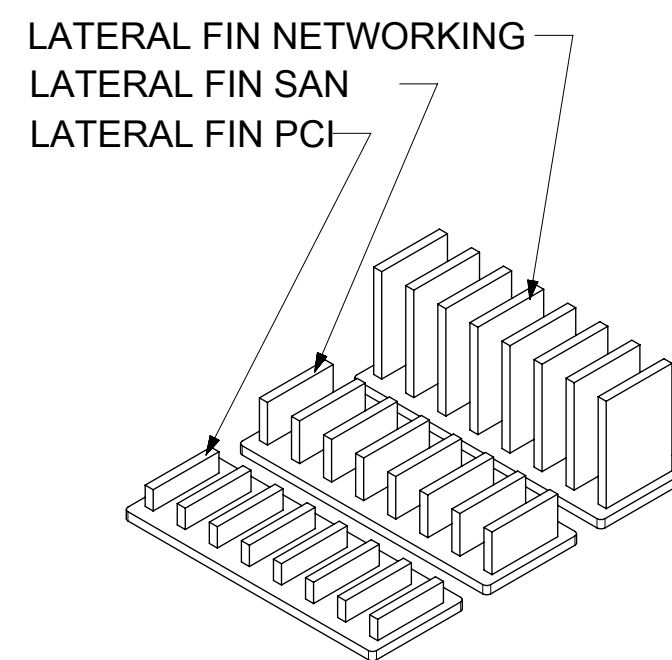

OVERALL HEATSINK HEIGHT

APPLICATION	DIM 'A'
PCI	14.3
SAN	16.6
NETWORKING	23.6

HEATSINK OPTIONS

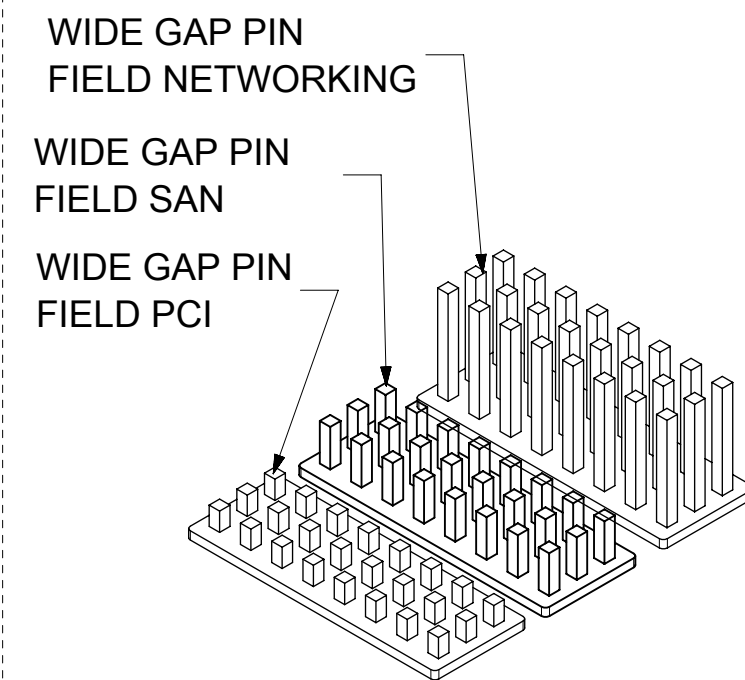

OVERALL HEATSINK HEIGHT

APPLICATION	DIM 'A'
PCI	14.3
SAN	16.6
NETWORKING	23.6
CUSTOM	13.5

NOTE: PCI-13ROWS
SAN-11ROWS
NETWORKING-10ROWS

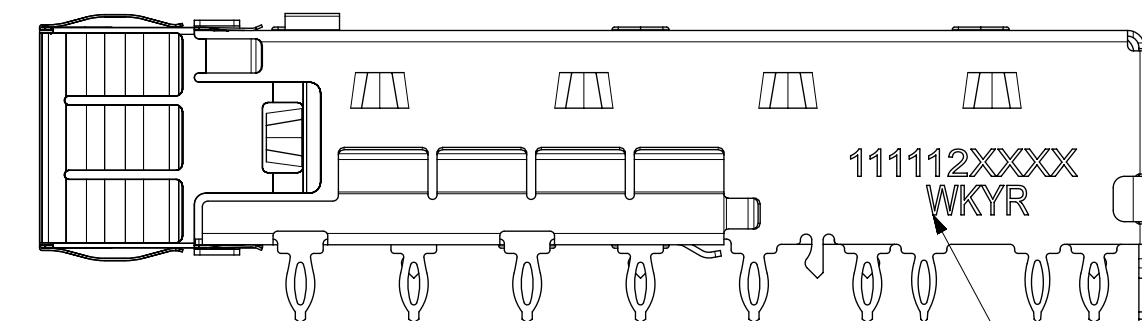
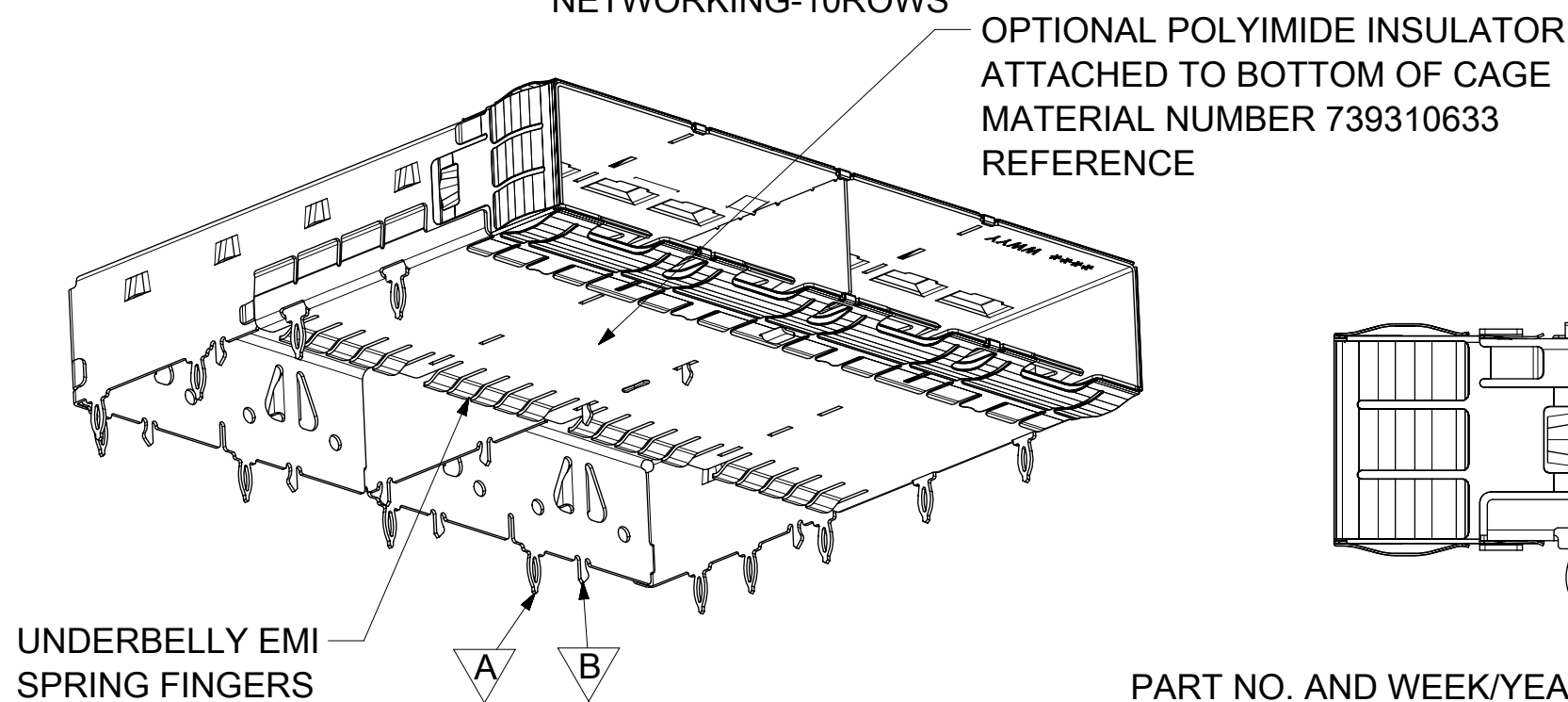
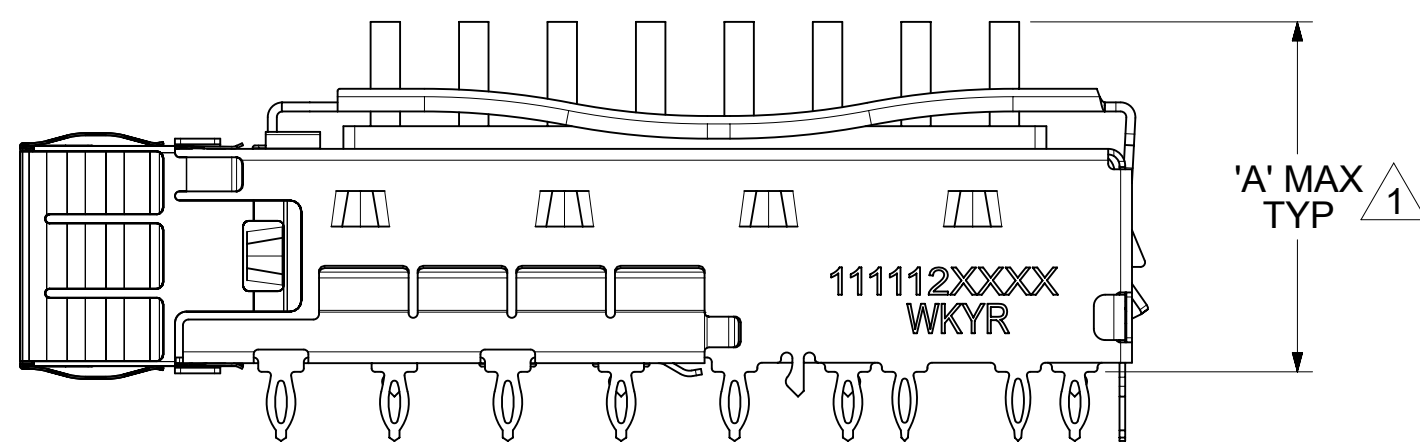

PART NO. AND WEEK/YEAR DATE CODE TO BE PRINTED ON THE SIDE OF COMPLETED CAGE ASSEMBLY APPROXIMATELY AS SHOWN FOR 11112 SERIES CAGE ASSEMBLIES.

NOTES:
1 HEIGHT OF HEATSINK WITH MODULE INSERTED.
DIMENSION MAY BE LESS DUE TO MODULE AND HEATSINK VARIATIONS.

REAR LEG OPTIONS (PER PORT)

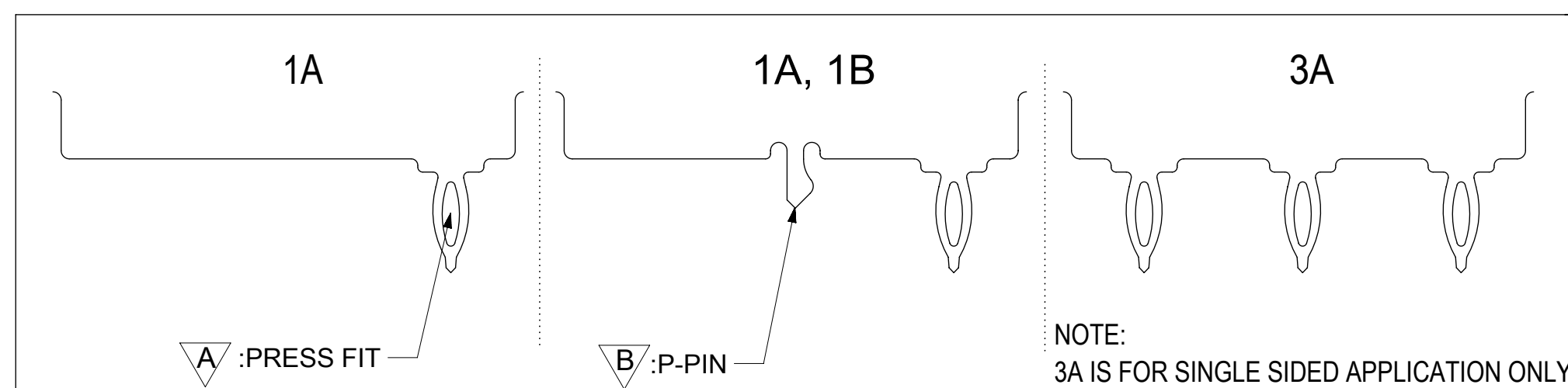

WEEK/YEAR DATE CODE TABLE	
WW	01 THRU 52 OR 53 EXAMPLE: 01 = FIRST WEEK OF YEAR 52 = LAST WEEK OF YEAR
YY	19, 20, 21,, ETC. EXAMPLE: YEAR 2019 = 19

THIS DRAWING CONTAINS INFORMATION THAT IS PROPRIETARY TO MOLEX ELECTRONIC TECHNOLOGIES, LLC AND SHOULD NOT BE USED WITHOUT WRITTEN PERMISSION			
DIMENSION UNITS mm	SCALE 2:1	CURRENT REV DESC: OBSOLETE PART NUMBERS AS PER PCN#509457.	
GENERAL TOLERANCES (UNLESS SPECIFIED)		<p>SFP+ 1X4 SF CAGE 3.05 MM PRESS FIT, HEAT SINKS, WITH EMI SPRING FINGERS</p>	
ANGULAR TOL	± 1.0°		
4 PLACES	±		
3 PLACES	±		
2 PLACES	± 0.15	EC NO: 680890	2020/01/16
1 PLACE	± 0.25	DRWN: ASYAMIKAR	2021/11/25
0 PLACES	±	CHK'D: GGA	2021/11/25
DRAFT WHERE APPLICABLE MUST REMAIN WITHIN DIMENSIONS		APPR: GGA	2021/11/25
THIRD ANGLE PROJECTION		INITIAL REVISION:	DOCUMENT NUMBER
DRAWING		DRWN: VK10	111122420
SERIES		APPR: RCHEN08	DOC TYPE
C-SIZE		2016/06/02	ASY
111112		2016/08/04	M2
SHEET NUMBER		MATERIAL NUMBER	REVISION
2 OF 8		SEE SHEET 3	
		CUSTOMER	

PART NUMBER SELECTION

1111122420

SHOWN

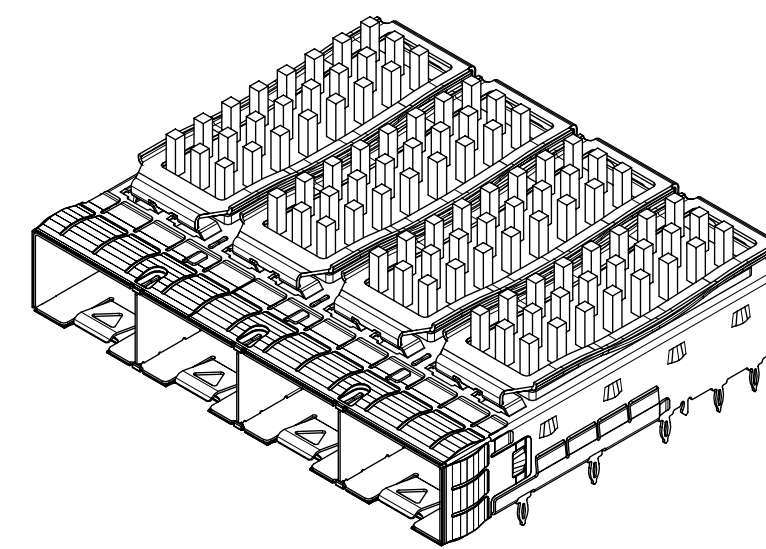
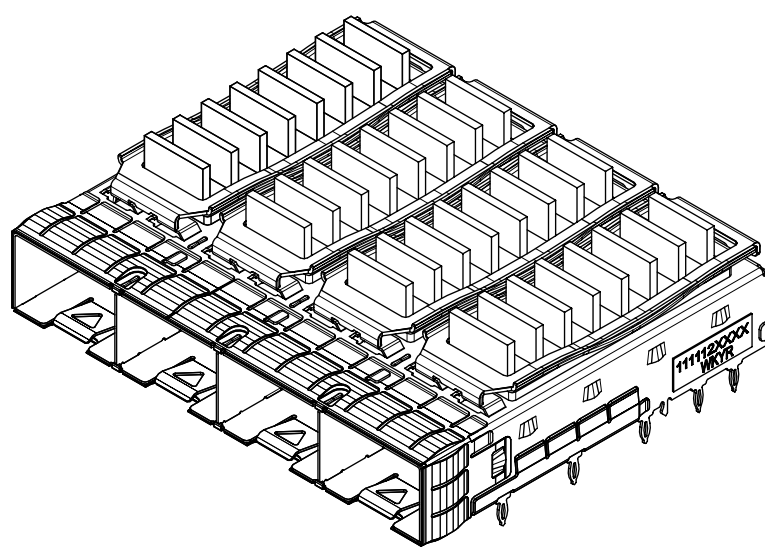
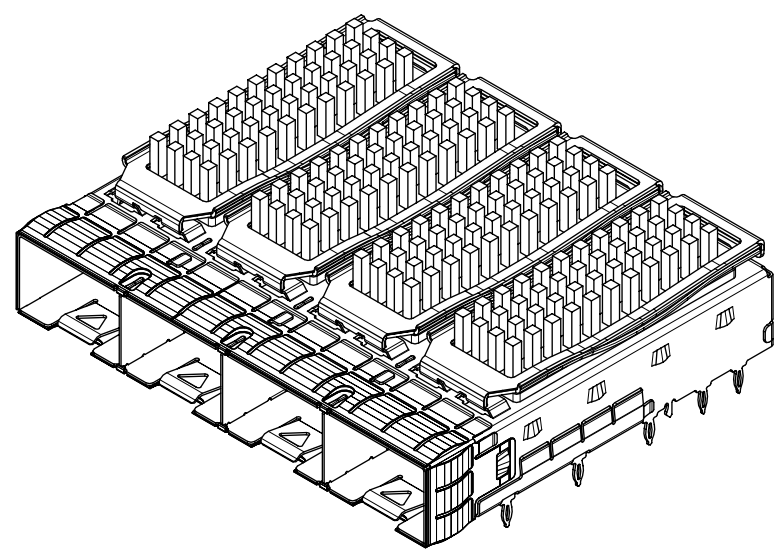

SFP+ PIN FIELD HEATSINK OPTION			
PART NO.	POLYIMIDE INSULATOR	HEAT SINK	# OF REAR LEGS PER PORT
1111122420	---	SAN	1A, 1B
1111123420	---	NET	1A, 1B
1111123460	YES	NET	1A, 1B

SFP+ LATERAL FIN HEATSINK OPTION			
PART NO.	POLYIMIDE INSULATOR	HEAT SINK	# OF REAR LEGS PER PORT
1111125421	---	SAN(*)	1A, 1B

SFP+ WIDE GAP PIN FIELD HEATSINK OPTION			
PART NO.	POLYIMIDE INSULATOR	HEAT SINK	# OF REAR LEGS PER PORT
1111127420	---	PCI	1A, 1B
1111127421	---	CUSTOM	1A, 1B

NOTE: PCI-13ROWS
SAN-11ROWS
NET-10ROWS

NOTE: (*)FAR LOW CAST

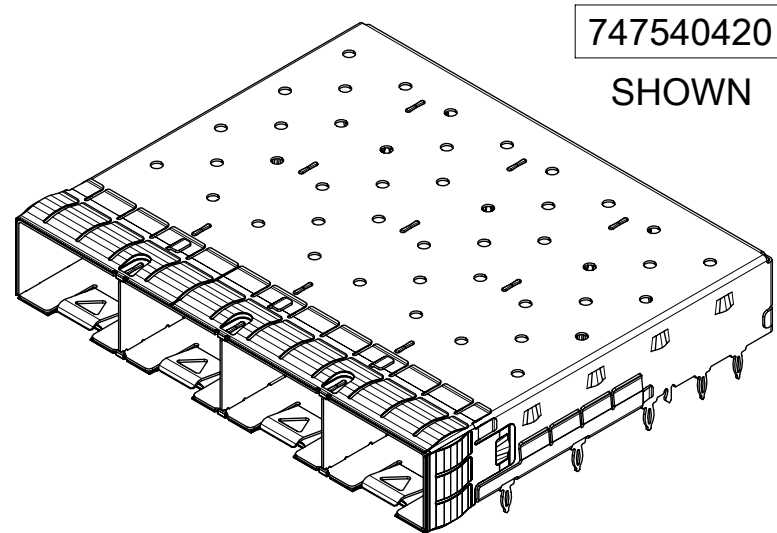

747540420
SHOWN

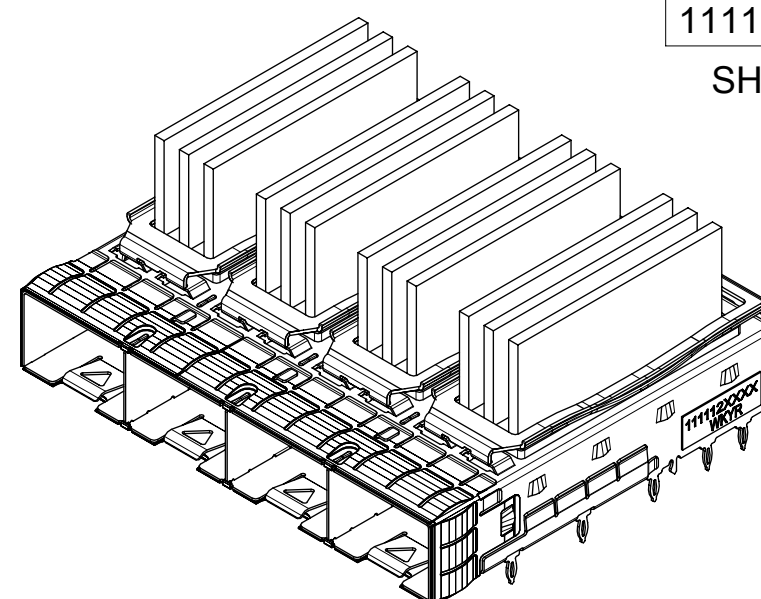

1111126421
SHOWN

SFP+ OPEN TOP BASE CAGE FOR HEATSINK				
PART NO.	POLYIMIDE INSULATOR	WELD POINT QUANTITY	# OF REAR LEGS PER PORT	PLATING
747540420	---	6	1A, 1B	----
747540423	---	19	1A, 1B	----
747540427	YES	6	1A, 1B	----
(15mm MAX PITCH BETWEEN ANY 2 WELD POINTS)				
747540464	---	6	1A, 1B	OVER ALL: MAT TIN PLATED 2.0µm MIN.

SFP+ CUSTOM FIN HEATSINK OPTION			
PART NO.	POLYIMIDE INSULATOR	HEAT SINK	# OF REAR LEGS PER PORT
1111126421	---	CUSTOM	1A, 1B

THIS DRAWING CONTAINS INFORMATION THAT IS PROPRIETARY TO MOLEX ELECTRONIC TECHNOLOGIES, LLC AND SHOULD NOT BE USED WITHOUT WRITTEN PERMISSION

DIMENSION UNITS mm	SCALE 4:3	CURRENT REV DESC: OBSOLETE PART NUMBERS AS PER PCN#509457.		molex			
GENERAL TOLERANCES (UNLESS SPECIFIED)		EC NO: 680890					
ANGULAR TOL ± 1.0°	4 PLACES ±	DRWN: ASYAMIKAR	2020/01/16	PRODUCT CUSTOMER DRAWING			
3 PLACES ±	2 PLACES ± 0.15	CHK'D: GGA	2021/11/25				
1 PLACE ± 0.25	0 PLACES ±	APPR: GGA	2021/11/25	DOCUMENT NUMBER 1111122420			
DRAFT WHERE APPLICABLE MUST REMAIN WITHIN DIMENSIONS		INITIAL REVISION: DRWN: VK10	2016/06/02				
THIRD ANGLE PROJECTION		APPR: RCHEN08	2016/08/04	MATERIAL NUMBER SEE SHEET 3		CUSTOMER	SHEET NUMBER 3 OF 8

PCB LAYOUT FOR SINGLE SIDE MOUNT

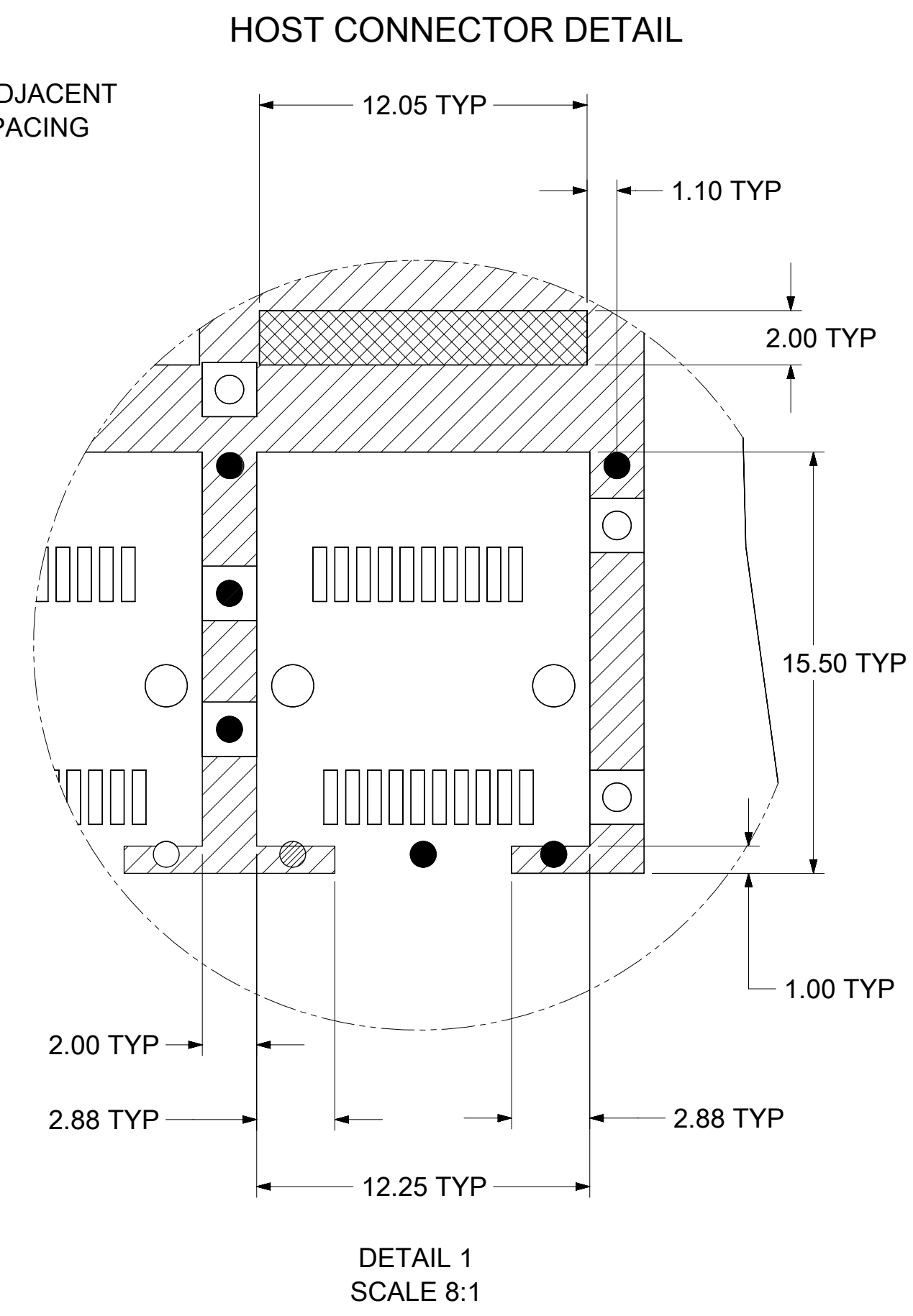
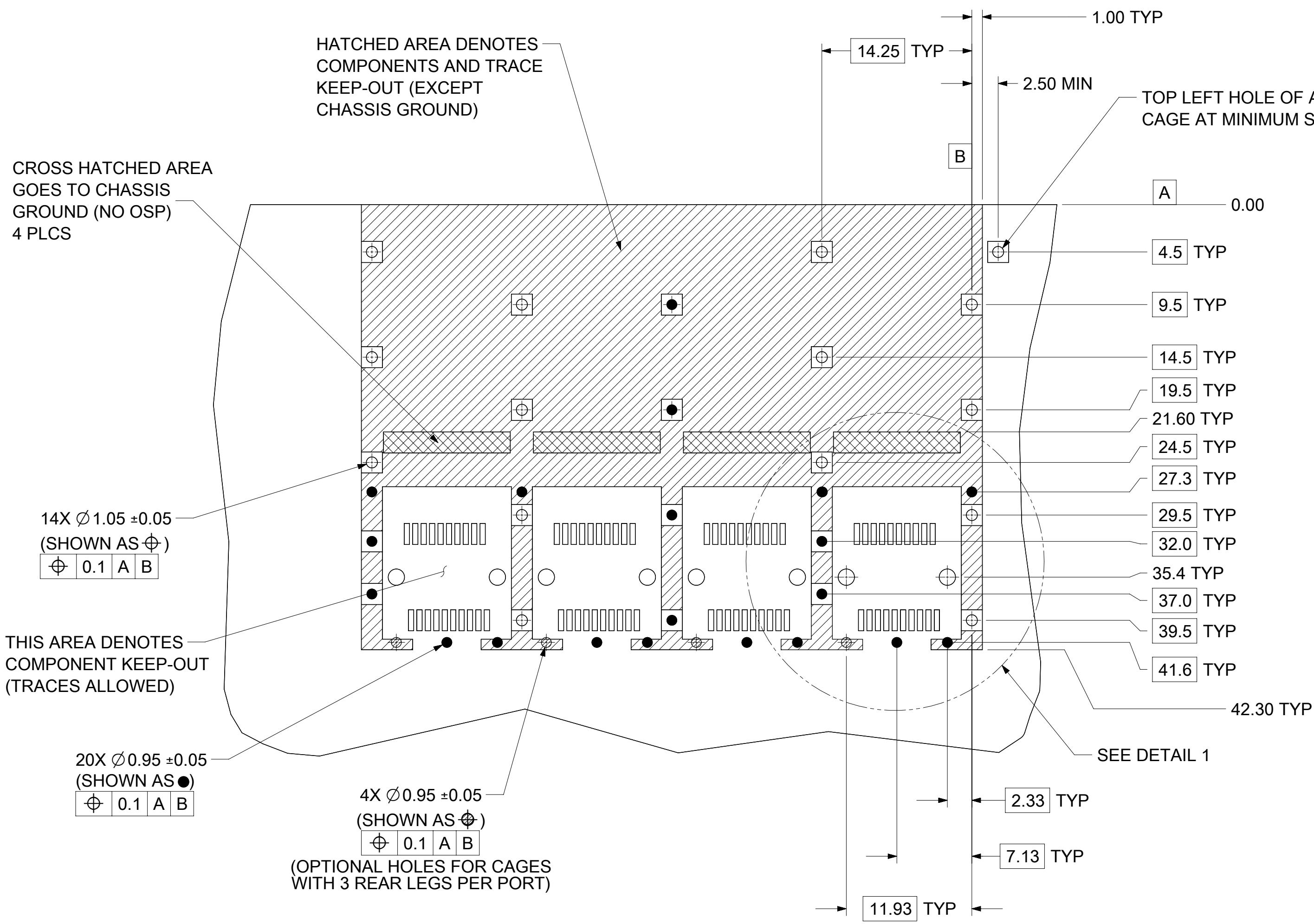

- NOTES:
1. PADS AND VIAS CONNECT TO CHASSIS GROUND (RECOMMENDED PADS TO BE 2.00mm SQUARE)
 2. RECOMMENDED THRU HOLE PLATING INCLUDES HASL, OSP, OR IMMERSION (GOLD, SILVER, OR TIN)
 3. CONNECTOR PAD LAYOUT PER SFP+ MSA WILL ACCOMMODATE MOLEX CONNECTOR SERIES 74441 OR EQUIVALENT
 4. HOLE PATTERN REPEATS FOR EACH PORT, SPACING BETWEEN PORTS IS 14.25mm
 5. MINIMUM PCB THICKNESS FOR SINGLE SIDED USE 1.57mm.

THIS DRAWING CONTAINS INFORMATION THAT IS PROPRIETARY TO MOLEX ELECTRONIC TECHNOLOGIES, LLC AND SHOULD NOT BE USED WITHOUT WRITTEN PERMISSION											
DIMENSION UNITS mm		SCALE 3:1		CURRENT REV DESC: OBSOLETE PART NUMBERS AS PER PCN#509457.				molex		SFP+ 1X4 SF CAGE 3.05 MM PRESS FIT, HEAT SINKS, WITH EMI SPRING FINGERS	
GENERAL TOLERANCES (UNLESS SPECIFIED)		ANGULAR TOL ± 1.0°		EC NO: 680890 DRWN: ASYAMIKAR 2020/01/16 CHK'D: GGA 2021/11/25 APPR: GGA 2021/11/25							
4 PLACES ±		3 PLACES ±		2 PLACES ± 0.15		1 PLACE ± 0.25		0 PLACES ±		PRODUCT CUSTOMER DRAWING	
DRAFT WHERE APPLICABLE MUST REMAIN WITHIN DIMENSIONS		THIRD ANGLE PROJECTION		DRAWING C-SIZE		SERIES 111112		MATERIAL NUMBER SEE SHEET 3		CUSTOMER 111122420	
DOCUMENT STATUS P1		RELEASE DATE 2021/11/25 12:19:23		INITIAL REVISION: DRWN: VK10 2016/06/02 APPR: RCHEN08 2016/08/04		DOCUMENT NUMBER 111122420		DOC TYPE PSD		DOC PART ASY	
										SHEET NUMBER M2	
										4 OF 8	

PCB LAYOUT FOR BELLY TO BELLY MOUNTING

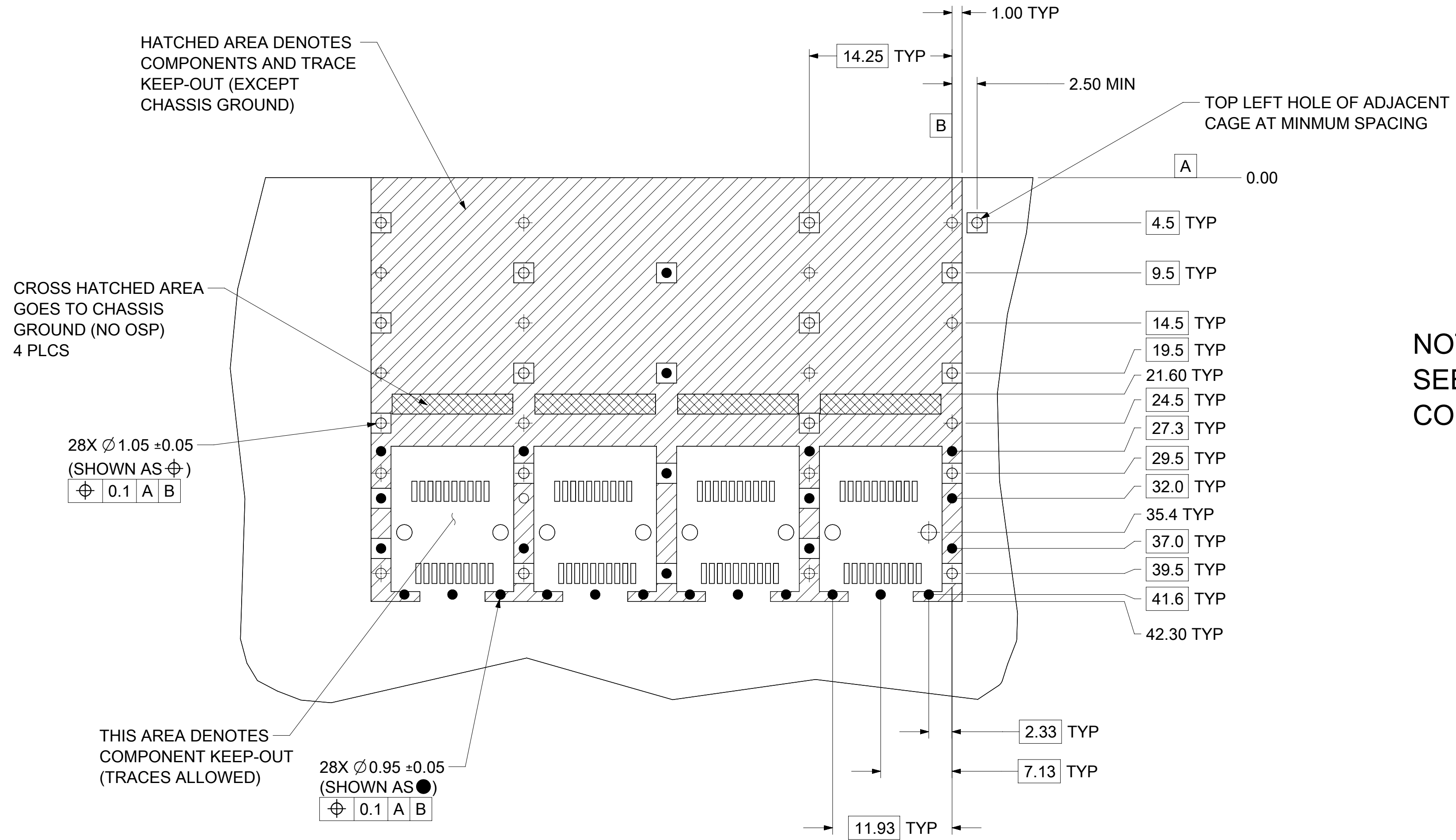

NOTE:
SEE SHEET 5 FOR HOST
CONNECTOR DETAIL

- NOTES:**
1. PADS AND VIAS CONNECT TO CHASSIS GROUND (RECOMMENDED PADS TO BE 2.00mm SQUARE)
 2. RECOMMENDED THRU HOLE PLATING INCLUDES HASL, OSP, OR IMMERSION (GOLD, SILVER, OR TIN)
 3. CONNECTOR PAD LAYOUT PER SFP+ MSA WILL ACCOMMODATE MOLEX CONNECTOR SERIES 74441 OR EQUIVALENT
 4. HOLE PATTERN REPEATS FOR EACH PORT, SPACING BETWEEN PORTS IS 14.25mm
 5. MINIMUM PCB THICKNESS FOR BELLY TO BELLY USE 3.00mm.

THIS DRAWING CONTAINS INFORMATION THAT IS PROPRIETARY TO MOLEX ELECTRONIC TECHNOLOGIES, LLC AND SHOULD NOT BE USED WITHOUT WRITTEN PERMISSION											
DIMENSION UNITS mm		SCALE 3:1		CURRENT REV DESC: OBSOLETE PART NUMBERS AS PER PCN#509457.				molex		SFP+ 1X4 SF CAGE 3.05 MM PRESS FIT, HEAT SINKS, WITH EMI SPRING FINGERS	
GENERAL TOLERANCES (UNLESS SPECIFIED)		ANGULAR TOL ± 1.0°		EC NO: 680890							
4 PLACES ±		3 PLACES ±		2 PLACES ± 0.15		1 PLACE ± 0.25		0 PLACES ±		PRODUCT CUSTOMER DRAWING	
DRWN: ASYAMIKAR		CHK'D: GGA		APPR: GGA		INITIAL REVISION:		DOCUMENT NUMBER		DOC TYPE DOC PART REVISION	
2020/01/16		2021/11/25		2021/11/25		DRWN: VK10		111122420		PSD ASY M2	
2016/06/02		2016/08/04		APPR: RCHEN08		SERIES		MATERIAL NUMBER		CUSTOMER	
DRAFT WHERE APPLICABLE MUST REMAIN WITHIN DIMENSIONS		THIRD ANGLE PROJECTION		DRAWING		SERIES		SEE SHEET 3		SHEET NUMBER	
		C-SIZE		111112						5 OF 8	

REV	DATE	DESCRIPTION
1	2011/06/21	INITIAL RELEASE
A	2011/06/29	UPDATED THE CAGE TOP TO INCLUDE HOLES FOR LIGHTPIPES.
B	2012/03/20	REVISED NOTES; HANGED HEATSINK HEIGHT FROM 8.63 TO 6.5; TABULARIZED PCI, SAN, AND NETWORKING; ADDED HEATSINK HEIGHT WITH MODULE INSERTED [SHT1]. MOVED EXPLODED VIEW TO SHT2. CHANGED OTHER SHEET NUMBER ACCORDINGLY. REMOVED NOTE 6 AND MOVED TO SHEET 2.
C	2012/07/31	HIDE HEATSINK CLIP FROM TOP VIEW, CHANGED DIM 49.0 TO 49.3 AND ADDED "SEE TABLE ON SHEET 2" TO ANNOTATION ON VIEW BOTTOM 3, ADDED MODEL NOTATION IN TOP CORNER ON SHEET 1, ADDED KAPTON TAPE MODEL TO EXPLODED VIEW ON SHEET 2, EXPANDED P/N TABLE ON SHEET 2 TO INCLUDE HEAT SINK DIMS AND KAPTON TAPE OPTIONS, REMOVED DIM 'B' FROM SHEET 2, REWORDED ANNOTATIONS FOR CORRECT ORIENTATION ON SHEET 5.
D	2012/08/31	REMOVED HEATSINKS AND CLIPS FROM ALL VIEWS ON SHEET 1; SEPERATED HEATSINKS TO SEPERATE VIEWS ON SHEET 2 AND REMOVED P/N FROM TABLES; ADDED NEW SHEET 3 WITH VIEWS AND P/N TABLES FOR NO HEATSINK, AND PINFIELD OR LATERAL FIN HEATSINKS; MOVED DIM "0.23 TYP" ON SHEET 6. ADDED ISO VIEWS AND PART NUMBER TABLES FOR WIDE GAP HEATSINKS TO SHEET 2 AND SHEET 3. ADDED TOP VIEWS OF SINGLE AND BELLY TO BELLY PCB TO SHEET SIX TO SHOW POLYIMIDE COVERAGE AND DIMENSIONS.
E	2013/02/20	1. CHANGED BASE CAGE VIEWS ON SHEET 1 FROM 111112-0432 TO 747540420. ADDED TYP TO DIMENSION 3.05 REF ON SIDE VIEW. MOVED DIMENSIONS "10.85 REF" TO F14, "14.0 ±0.1" TO D17, "56.75 REF" TO F17, "58.65 REF" TO G17. ADDED DIMENSION "9.98 REF" @E7. CHANGED DIMENSION 49.03 TO 49.0 @ J14. ADDED BACK VIEW, @E3. REMOVED BELLY ISO VIEW AND ROTATED TOP ISO VIEW & MOVED TO J7. MOVED PCB MIN THICKNESS FROM NOTE 2 TO RESPECTIVE PCB LAYOUT SHEETS. REMOVED INSERTION FORCE FROM NOTE 2. ADDED APPLICATION NOTE @H10. UPDATED P/N DATE CODE PRINTING CALLOUT ON SIDE VIEW. UPDATED 3D MODEL P/N @M20. ADDED EMI SPRING FINGERS NOTE @H8. (SHEET 1) 2. MOVED POLYIMIDE BELLY ISO VIEW TO E9 AND ADDED REAR LEG & UNDER BELLY SPRING FINGER IDENTIFIERS. ADDED UNDERBELLY GASKET ISO VIEW @E3. ADDED TOP VIEW, @ J17. REMOVED CAGES FROM HEATSINK VIEWS. ADDED REAR LEG OPTIONS, @B16. ADDED TITLE FOR TABLES THAT READS OVERALL HEATSINK HEIGHT. ADDED POLYIMIDE INSULATOR & # OF REAR LEGS PER PORT COLUMNS TO TABLES. (SHEET 2) 3. ADDED PN'S 747500420, -0422, -0423 & 111110420 AND UPDATED TABLES, ADDING ISO VIEWS @F18 & F13. ADDED P/N NOTE FOR EACH CAGE SHOWN. (SHEET 3) 4. ADDED NOTE 5, (SHEET 4 & 5). REMOVED UNNECESSARY CAGE TO PCB CONTACT PADS FROM BELLY TO BELLY LAYOUT. ADDED TYP TO ALL DIMENSIONS (SHEET 4 & 5). ADDED DIAMETER DIMENSION 0.95±0.05 X4 WITH NOTES "SHOWN AS..." (SHEET 4). FIXED BOX TO NOT INCLUDE TYP. ADDED HOLES @E17, @E15, @E13, & E11 (SHEET 4). REMOVED PAD @F13 (SHEET 5). 5. REMOVED BELLY TO BELLY VIEW AND CENTERED & INCREASED SCALE OF SINGLE SIDED VIEW. (SHEET 6) 6. REMOVED "SEE NOTE 1" FROM DIMENSION "10.4 ±0.1", @E12 & D12. ADDED "SEE NOTE 1" BEZEL OPENING PITCH, @E12. ADDED CENTER LINES TO BEZEL OPENINGS. REMOVED CUTAWAY 7 & 8 FROM SIDE VIEWS. RENAMED CUTAWAY2 TO 1 AND 4 TO 2. REMOVED "SIZE, AND" FROM NOTE 1. ADDED DIMENSION 12.44 REF TYP TO BOTH SIDE VIEWS. REMOVED DIMENSION 9.98 TYP @E4 & J4. (SHEET 7)
F	2013/09/06	ADDED PN'S 747540426. (SHEET 3)
G	2013/10/14	1. CHANGED THE WORD "WILL" TO "MAY" ON NOTE 4. MOVED DATE CODE FROM SIDE OF CAGE TO BACK OF CAGE, ADDED NOTE AT E5 TO LIST THE SERIES NUMBERS THAT WILL HAVE THE DATE CODE INTHIS LOCATION. ADDED 0.70 MAX(BENDING TAB TO BOTTOM SURFACE OF BASE) AT E13. (SHEET 1) 2. REMOVED zSFP+ CAGE VIEW FROM SHEET AT E5, ADDED SIDE VIEW OF CAGE TO SHOW WHERE THE DATE CODE WILL BE ON ALL 111112 SERIES CAGES. (SHEET 2) 3. ADDED NEW SHEET 3 WITH GEN 1 AND GEN 2 zSFP+ OPTIONS. THE PREVIOUS SHEETS FROM SHEET 3 TO SHEET 8 ALL INCREASE BY 1 NUMBER. 4. ADDED P/N 747540427 TO TABLE AT D20 AND ADDED ISO VIEW AND TABLE FOR 1001140420 AT E3 ON SHEET 4.

THIS DRAWING CONTAINS INFORMATION THAT IS PROPRIETARY TO MOLEX ELECTRONIC TECHNOLOGIES, LLC AND SHOULD NOT BE USED WITHOUT WRITTEN PERMISSION									
DIMENSION UNITS		SCALE		CURRENT REV DESC: OBSOLETE PART NUMBERS AS PER PCN#509457.				molex	
mm		1:1							
GENERAL TOLERANCES (UNLESS SPECIFIED)				EC NO: 680890				SFP+ 1X4 SF CAGE 3.05 MM PRESS FIT, HEAT SINKS, WITH EMI SPRING FINGERS	
ANGULAR TOL ± 1.0°				DRWN: ASYAMIKAR 2020/01/16				PRODUCT CUSTOMER DRAWING	
4 PLACES ±				CHK'D: GGA 2021/11/25				DOCUMENT NUMBER	
3 PLACES ±				APPR: GGA 2021/11/25				111122420	
2 PLACES ± 0.15				INITIAL REVISION:				DOC TYPE	
1 PLACE ± 0.25				DRWN: VK10 2016/06/02				PSD	
0 PLACES ±				APPR: RCHEN08 2016/08/04				DOC PART	
DRAFT WHERE APPLICABLE MUST REMAIN WITHIN DIMENSIONS				THIRD ANGLE PROJECTION		DRAWING		REVISION	
						C-SIZE		M2	
				SERIES		MATERIAL NUMBER		SHEET NUMBER	
				111112		SEE SHEET 3		7 OF 8	

DOCUMENT STATUS	P1	RELEASE DATE	2021/11/25 12:19:23
-----------------	----	--------------	---------------------

REV	DATE	DESCRIPTION
H	2014/09/24	1. ADDED 74754-0426 PLATING SPEC. [SHEET 4] 2. ADDED P/N 74754-0464. [SHEET 4]
I	2015/08/26	1. SHEET 3 : ADDED NOTE 2 2. SHEET 2: J13 : ADDED NEW VERTICAL FIN HEATSINK ISO VIEW 3. SHEET 4: H10 : ADDED (*) FOR LOW COST IN NOTE 4. SHEET 4: I10 : ADDED PART NO. 111112-5421 ON P/N TABLE 5. SHEET 5: K18 : ADDED PART NO. 111112-6421 ISOVIEW 6. SHEET 6: G20 : CHANGED $\varnothing 1.05 \pm 0.05$ X14 TO $\varnothing 14 \times 1.05 \pm 0.05$ 7. SHEET 6: D19 : CHANGED $\varnothing 0.95 \pm 0.05$ X20 TO $\varnothing 20 \times 0.95 \pm 0.05$ 8. SHEET 6: D14 : CHANGED $\varnothing 0.95 \pm 0.05$ X4 TO $\varnothing 4 \times 0.95 \pm 0.05$ 9. SHEET 7: G18 : CHANGED $\varnothing 1.05 \pm 0.05$ X28 TO $\varnothing 28 \times 1.05 \pm 0.05$ 10. SHEET 7: C16 : CHANGED $\varnothing 0.95 \pm 0.05$ X28 TO $\varnothing 28 \times 0.95 \pm 0.05$ 11. SHEET 9: ADDED NOTE 2 MODIFIED PCB LAYOUT PER SFF-8433 12. SHEET 6: G20 : CHANGED TURE POSITION OF PCB HOLES FORM 0.05 TO 0.1 C19 : CHANGED TURE POSITION OF PCB HOLES FORM 0.05 TO 0.1 C14 : CHANGED TURE POSITION OF PCB HOLES FORM 0.05 TO 0.1 13. SHEET 7 : F18 : CHANGED TURE POSITION OF PCB HOLES FORM 0.05 TO 0.1 C16 : CHANGED TURE POSITION OF PCB HOLES FORM 0.05 TO 0.1
J	2016/02/02	1. SHEET 3 & 4: REMOVE 1111110420
K	2016/03/25	SHEET 4: H19: ADDED 1111120494 IN P/N TABLE
L	2016/06/30	REMASTERED FROM SD-111112-2420 REV_K TO 1111122420 PSD ASY REV_L SEPERATED 1001140420 TO 1001140420 PSD ASY
M	2019/01/09	SHEET 2: D7: SHOWED POLYIMIDE INSULATOR IN THE VIEW. SHEET 1: B3: REMOVED 111111 SERIES FROM DATE CODE NOTE
M1	2019/04/10	SHEET 2 : E02 : ADDED NEW ROW OF CUSTOM HEAT SINK WITH HEIGHT 13.7. SHEET 3 : E03 : ADDED NEW P/N 1111127421 IN PART NUMBER TABLE.
M2	2020/01/16	1. SHEET 2 : E01: CUSTOM HEATSINK HEIGHT CHANGED FROM 13.7 TO 13.5. 2. OBSOLETED P/N 747540422/747540426/1111120410/1111120420/1111120460/1111121420/1111121460/ 1111122460/1111124420/1111124460/1111125420/1111125460/1111126420/1111126460/ 1111127460/1111128420/1111128460/1111129420/1111129460.

THIS DRAWING CONTAINS INFORMATION THAT IS PROPRIETARY TO MOLEX ELECTRONIC TECHNOLOGIES, LLC AND SHOULD NOT BE USED WITHOUT WRITTEN PERMISSION									
DIMENSION UNITS	SCALE	CURRENT REV DESC: OBSOLETED PART NUMBERS AS PER PCN#509457.			molex				
mm	1:1								
GENERAL TOLERANCES (UNLESS SPECIFIED)					SFP+ 1X4 SF CAGE 3.05 MM PRESS FIT, HEAT SINKS, WITH EMI SPRING FINGERS				
ANGULAR TOL	$\pm 1.0^\circ$	EC NO: 680890			PRODUCT CUSTOMER DRAWING				
4 PLACES	\pm	DRWN: ASYAMIKAR 2020/01/16			DOCUMENT NUMBER				
3 PLACES	\pm	CHK'D: GGA 2021/11/25			1111122420				
2 PLACES	± 0.15	APPR: GGA 2021/11/25			DOC TYPE		DOC PART		REVISION
1 PLACE	± 0.25	INITIAL REVISION:			PSD		ASY		M2
0 PLACES	\pm	DRWN: VK10 2016/06/02			MATERIAL NUMBER		CUSTOMER		SHEET NUMBER
DRAFT WHERE APPLICABLE MUST REMAIN WITHIN DIMENSIONS		THIRD ANGLE PROJECTION		DRAWING		SERIES		SEE SHEET 3	
				C-SIZE		111112		8 OF 8	

DOCUMENT STATUS	P1	RELEASE DATE	2021/11/25 12:19:23
-----------------	----	--------------	---------------------

3D MODEL: TM-11112-2420

BASE CAGE DETAILS

(APPLIES TO ALL CAGES IN THIS DRAWING)

747540420
SHOWN

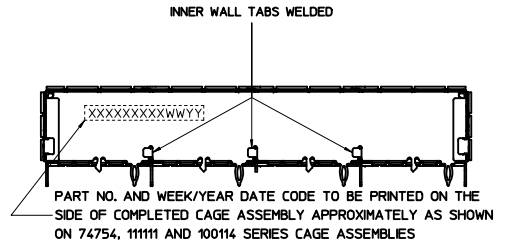
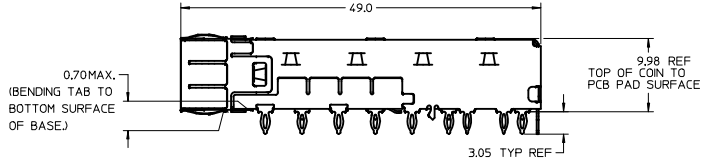
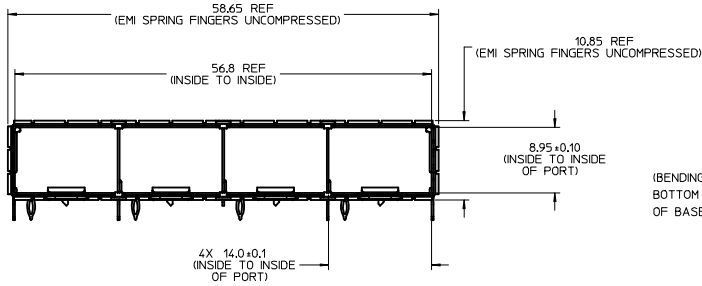
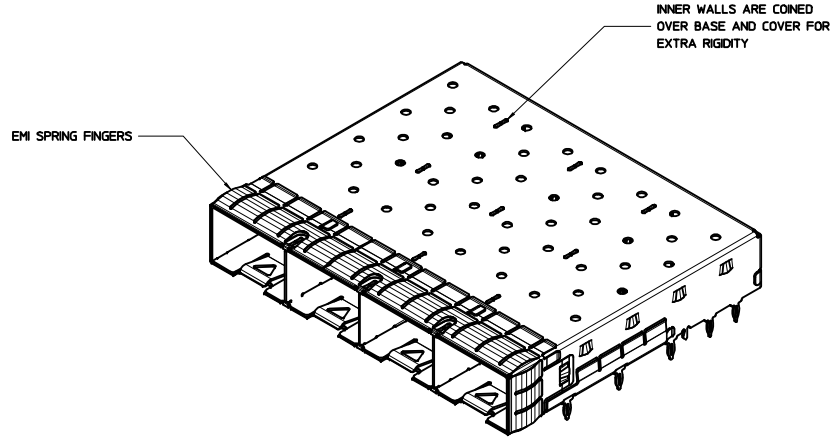
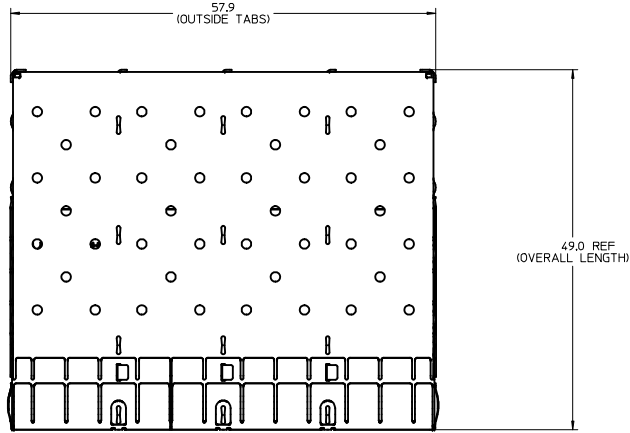

WEEK/YEAR DATE CODE TABLE	
WW	01 THRU 52 OR 53 EXAMPLE: 01 = FIRST WEEK OF YEAR 52 = LAST WEEK OF YEAR
YY	11, 12, 13 ETC. EXAMPLE: YEAR 2013 = 13

- NOTES:**
- MATERIAL:**
 CAGE: 0.25mm THICK COPPER ALLOY, NICKEL PLATED.
 SPRING FINGERS: 0.10mm THICK COPPER ALLOY, NICKEL PLATED.
 HEATSINK: ALUMINUM, NICKEL PLATED.
 HEATSINK SPRING CLIP: STAINLESS STEEL.
 - PRESS FIT LEGS 3.05mm [.120 INCH] LONG.
 - PORTS ARE DESIGNED FOR SFP+ TRANSCEIVERS AND ARE COMPATIBLE WITH SFP TRANSCEIVERS.
 THE TOP SURFACE OF THE MODULE MUST BE FLAT (NO PRODUCT LABEL RECESS) AND THERMALLY CONDUCTIVE TO FUNCTION OPTIMALLY.
 - WELD SPOT MAY SHOW SLIGHT MATERIAL DISCOLORATION.
 - NO ROHS EXEMPTIONS.
 - CUSTOM HEATSINKS AVAILABLE UPON REQUEST.

SEE REVISION TABLE EC NO: CPG2016-2974 DRAWN: CHENG03 CHKD: APPR: CHEN08 REV	QUALITY SYMBOLS ▽=0 ▽=0 ▽=0	GENERAL TOLERANCES (UNLESS SPECIFIED)		DIMENSION STYLE		SCALE 3:1	DESIGN UNITS METRIC	THIRD ANGLE PROJECTION	
		mm	INCH	MM ONLY	DATE				
		4 PLACES ±---	±---	DRAWN BY RMIKLINSKI	DATE 2011/06/20			TITLE SFP+ 1X4 CAGE, .120 INCH PRESS FIT, HEAT SINKS WITH EMI SPRING FINGERS molex DOCUMENT NO. SD-11112-2420	
		3 PLACES ±---	±---	CHECKED BY MCKERVEY	DATE 2011/08/26				
		2 PLACES ±0.15	±---	APPROVED BY	DATE				
		1 PLACE ±0.25	±---	KLLOYD	2012/08/14				
		0 PLACE ±	±					SHEET NO. 1 OF 10	
DRAFT WHERE APPLICABLE MUST REMAIN WITHIN DIMENSIONS		ANGULAR ± 1°		MATERIAL NO. SEE SHEET 4		SIZE D		THIS DRAWING CONTAINS INFORMATION THAT IS PROPRIETARY TO MOLEX INCORPORATED AND SHOULD NOT BE USED WITHOUT WRITTEN PERMISSION	

CAGE ASSEMBLY OPTIONS

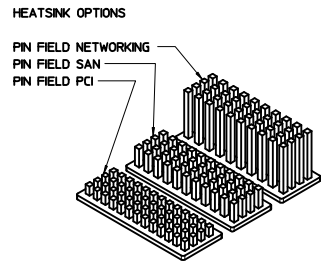
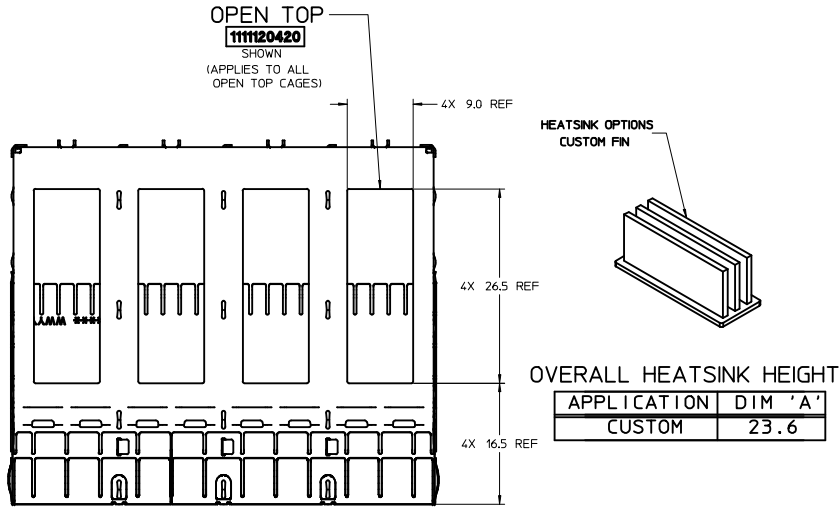

OVERALL HEATSINK HEIGHT

APPLICATION	DIM 'A'
PCI	14.3
SAN	16.6
NETWORKING	23.6

NOTE: PCI - 13 ROWS
SAN - 11 ROWS
NETWORKING - 10 ROWS

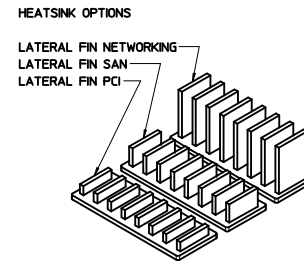

OVERALL HEATSINK HEIGHT

APPLICATION	DIM 'A'
PCI	14.3
SAN	16.6
NETWORKING	23.6

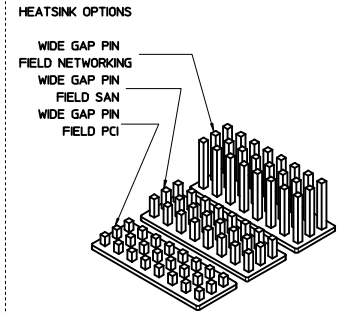

OVERALL HEATSINK HEIGHT

APPLICATION	DIM 'A'
PCI	14.3
SAN	16.6
NETWORKING	23.6

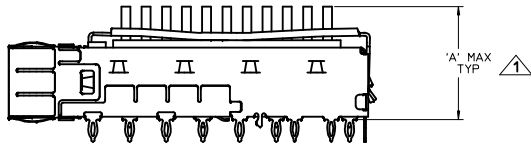

NOTES:
▲ HEIGHT OF HEATSINK WITH MODULE INSERTED.
DIMENSION MAY BE LESS DUE TO MODULE AND HEATSINK VARIATIONS.

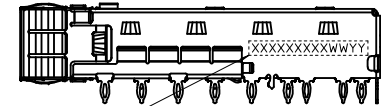
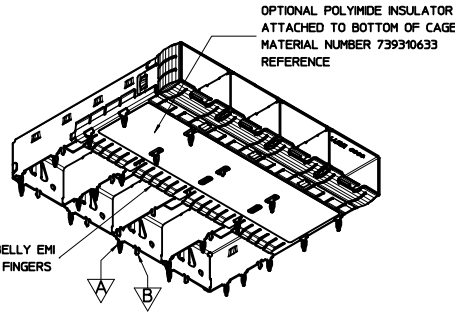

PART NO. AND WEEK/YEAR DATE CODE TO BE PRINTED ON THE SIDE OF COMPLETED CAGE ASSEMBLY APPROXIMATELY AS SHOWN FOR 11112 SERIES CAGE ASSEMBLIES.

WEEK/YEAR DATE CODE TABLE

WW	YY
01 THRU 52 OR 53	EXAMPLE: 01 = FIRST WEEK OF YEAR 52 = LAST WEEK OF YEAR
11, 12, 13 ETC.	EXAMPLE: YEAR 2013 = 13

REAR LEG OPTIONS (PER PORT)

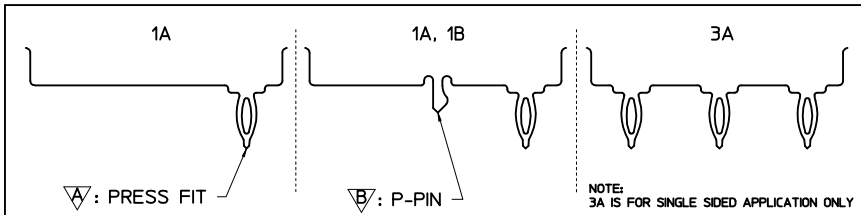

QUALITY SYMBOLS	GENERAL TOLERANCES (UNLESS SPECIFIED)		DIMENSION STYLE		SCALE	DESIGN UNITS	THIRD ANGLE PROJECTION
	mm	INCH	MM ONLY	DATE			
▽=0	4 PLACES	±.005	±.0005	DATE	3:1	METRIC	SFP+ 1X4 CAGE, .120 INCH PRESS FIT, HEAT SINKS WITH EMI SPRING FINGERS molex
▽=0	3 PLACES	±.008	±.0008	DATE			
▽=0	2 PLACES	±0.15	±.0015	DATE			
▽=0	1 PLACE	±0.25	±.0025	DATE			
▽=0	0 PLACE	±	±	DATE			
ANGULAR ± 1°			MATERIAL NO.		DOCUMENT NO.		SHEET NO.
DRAFT WHERE APPLICABLE MUST REMAIN WITHIN DIMENSIONS			SEE SHEET 4		SD-11112-2420		2 OF 10
THIS DRAWING CONTAINS INFORMATION THAT IS PROPRIETARY TO MOLEX INCORPORATED AND SHOULD NOT BE USED WITHOUT WRITTEN PERMISSION							

OPTIONAL GEN 2 UNDER BELLY GASKET

1001140420
SHOWN

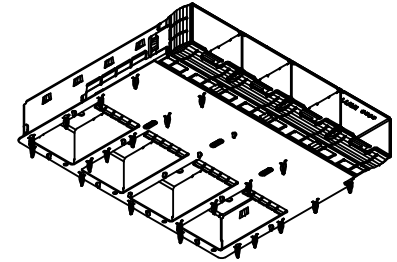
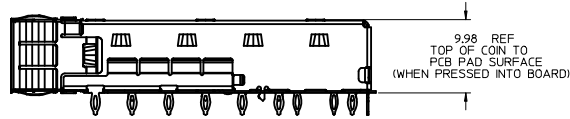
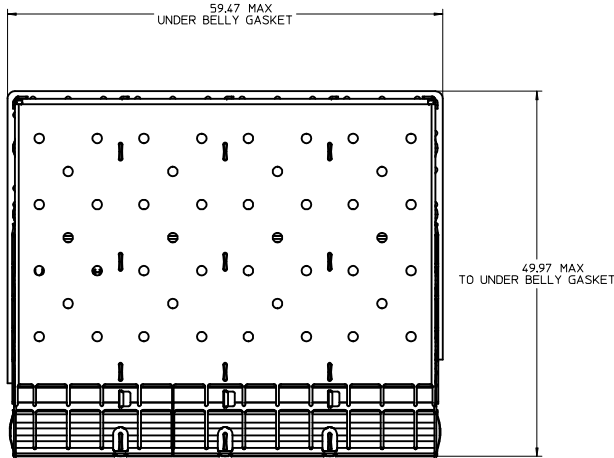

- NOTES:
- OPTIONAL UNDER BELLY GASKET ATTACHED TO BOTTOM OF CAGE (SEE P/N TABLES FOR AVAILABLE ASSEMBLIES).
 - GEN 2 UNDER BELLY GASKET IS UL94 V-0 RATED.

SEE REVISION TABLE IEC NO: CPG2016-2974 J CHYD: APPR:RCHEN03 2016/02/04 REV DESCRIPTION	QUALITY SYMBOLS	GENERAL TOLERANCES (UNLESS SPECIFIED)	DIMENSION STYLE	SCALE	DESIGN UNITS	THIRD ANGLE PROJECTION
	▽=0	mm INCH	MM ONLY	3:1	METRIC	☉
	▽=0	4 PLACES ± --- ± ---	DRAWN BY DATE			
	▽=0	3 PLACES ± --- ± ---	RM IKLINSKI 2011/06/20			
	2 PLACES ± 0.15 ± ---	CHECKED BY DATE				TITLE
	1 PLACE ± 0.25 ± ---	MCKERVEY 2011/08/26				SFP+ 1X4 CAGE, .120 INCH PRESS FIT, HEAT SINKS, WITH EMI SPRING FINGERS
	0 PLACE ± ±	APPROVED BY DATE				molex
		KLLOYD 2012/08/14	MATERIAL NO.	DOCUMENT NO.		SHEET NO.
			SEE SHEET 4	SD-11112-2420		3 OF 10
		ANGULAR ± 1 °	THIS DRAWING CONTAINS INFORMATION THAT IS PROPRIETARY TO MOLEX INCORPORATED AND SHOULD NOT BE USED WITHOUT WRITTEN PERMISSION			
		DRAFT WHERE APPLICABLE MUST REMAIN WITHIN DIMENSIONS				

PART NUMBER SELECTION

1111120420
SHOWN

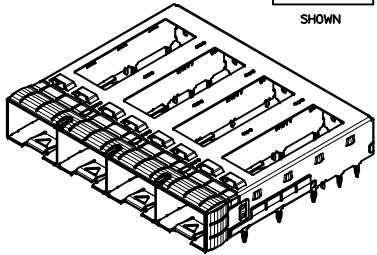

SFP+ OPEN TOP BASE CAGE FOR HEATSINK		
PART NO.	POLYIMIDE INSULATOR	# OF REAR LEGS PER PORT
1111120420	---	1A, 1B
1111120460	YES	1A, 1B

1111122420
SHOWN

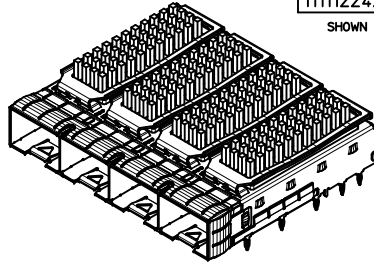

SFP+ PIN FIELD HEATSINK OPTION			
PART NO.	POLYIMIDE INSULATOR	HEATSINK	# OF REAR LEGS PER PORT
1111121420	---	PCI	1A, 1B
1111121460	YES	PCI	1A, 1B
1111122420	---	SAN	1A, 1B
1111122460	YES	SAN	1A, 1B
1111123420	---	NET	1A, 1B
1111123460	YES	NET	1A, 1B

NOTE: PCI - 13 ROWS
SAN - 11 ROWS
NET - 10 ROWS

1111125420
SHOWN

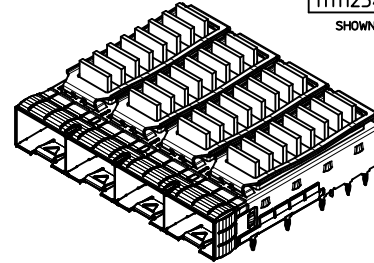

SFP+ LATERAL FIN HEATSINK OPTION			
PART NO.	POLYIMIDE INSULATOR	HEATSINK	# OF REAR LEGS PER PORT
1111124420	---	PCI	1A, 1B
1111124460	YES	PCI	1A, 1B
1111125420	---	SAN	1A, 1B
1111125421	---	SAN(*)	1A, 1B
1111125460	YES	SAN	1A, 1B
1111126420	---	NET	1A, 1B
1111126460	YES	NET	1A, 1B

NOTE: (*) FOR LOW COST

1111128420
SHOWN

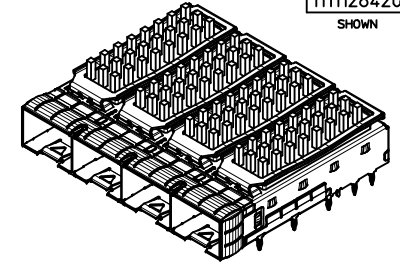

SFP+ WIDE GAP PIN FIELD HEATSINK OPTION			
PART NO.	POLYIMIDE INSULATOR	HEATSINK	# OF REAR LEGS PER PORT
1111127420	---	PCI	1A, 1B
1111127460	YES	PCI	1A, 1B
1111128420	---	SAN	1A, 1B
1111128460	YES	SAN	1A, 1B
1111129420	---	NET	1A, 1B
1111129460	YES	NET	1A, 1B

747540420
SHOWN

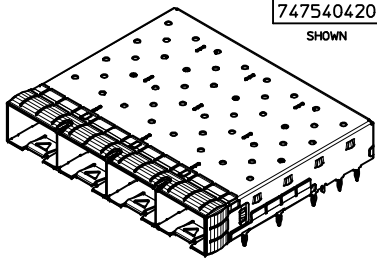

SFP+ CLOSED TOP BASE CAGE				
PART NO.	POLYIMIDE INSULATOR	WELD POINT QUANTITY	# OF REAR LEGS PER PORT	PLATING
747540420	---	6	1A, 1B	----
747540422	---	6	3A	----
747540423	---	19	1A, 1B	----
747540427	YES	6 <small>(15mm MAX PITCH BETWEEN ANY 2 WELD POINTS)</small>	1A, 1B	----
747540464	---	6	1A, 1B	OVER ALL: MAT TIN PLATED 2.0MM MIN.

1001140420
SHOWN

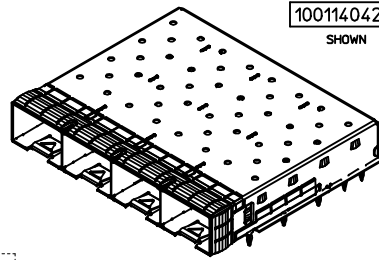

zSFP+ CLOSED TOP BASE CAGE W/ GEN 2 BELLY GASKET	
PART NO.	# OF REAR LEGS PER PORT
1001140420	1A, 1B

747540426
SHOWN

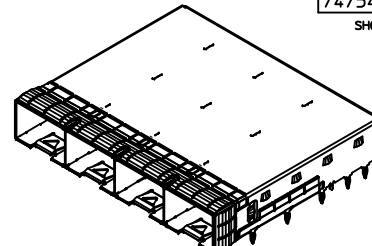

SFP+ CLOSED TOP BASE CAGE			
PART NO.	WELD POINT QUANTITY	# OF REAR LEGS PER PORT	PLATING
747540426	6 <small>(15mm MAX PITCH BETWEEN ANY 2 WELD POINTS)</small>	1A, 1B	OVER ALL: MAT TIN PLATED 2.0MM MIN.

1111126421
SHOWN

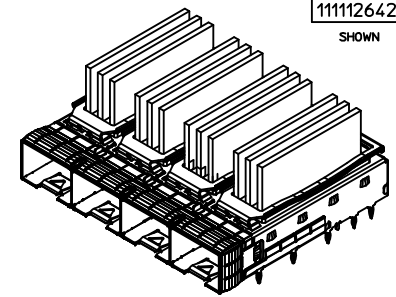

SFP+ CUSTOM FIN HEATSINK OPTION			
PART NO.	POLYIMIDE INSULATOR	HEATSINK	# OF REAR LEGS PER PORT
1111126421	---	CUSTOM	1A, 1B

SEE REVISION TABLE EC NO: CPG2016-2974 DRAWN: ACHENG03 CHKD: APPROV: CHENG08 2016/02/02	QUALITY SYMBOLS ∇=0 ∇=0 ∇=0	GENERAL TOLERANCES (UNLESS SPECIFIED)		DIMENSION STYLE MM ONLY	SCALE 2:1	DESIGN UNITS METRIC	THIRD ANGLE PROJECTION		
		4 PLACES ± 0.15 3 PLACES ± 0.25 2 PLACES ± 0.50 1 PLACE ± 1.00 0 PLACE ±	mm INCH	DRAWN BY RMIKLINSKI	DATE 2011/06/20	TITLE SFP+ 1X4 CAGE, .120 INCH PRESS FIT, HEAT SINKS, WITH EMI SPRING FINGERS			
		ANGULAR ± 1° DRAFT WHERE APPLICABLE MUST REMAIN WITHIN DIMENSIONS	MATERIAL NO. SEE TABLE	DATE 2011/08/26	APPROVED BY KLOYD	DATE 2012/08/14	DOCUMENT NO. SD-11112-2420		
				THIS DRAWING CONTAINS INFORMATION THAT IS PROPRIETARY TO MOLEX INCORPORATED AND SHOULD NOT BE USED WITHOUT WRITTEN PERMISSION		SHEET NO. 4 OF 10			

PCB LAYOUT FOR SINGLE SIDE MOUNT

HATCHED AREA DENOTES COMPONENTS AND TRACE KEEP-OUT (EXCEPT CHASSIS GROUND)

CROSS HATCHED AREA GOES TO CHASSIS GROUND (NO OSP) 4 PLCS

14X $\phi 1.05 \pm 0.05$ (SHOWN AS $\phi 0.1AB$)

THIS AREA DENOTES COMPONENT KEEP-OUT (TRACES ALLOWED)

20X $\phi 0.95 \pm 0.05$ (SHOWN AS $\phi 0.1AB$)

4X $\phi 0.95 \pm 0.05$ (SHOWN AS $\phi 0.1AB$)
(OPTIONAL HOLES FOR CAGES WITH 3 REAR LEGS PER PORT)

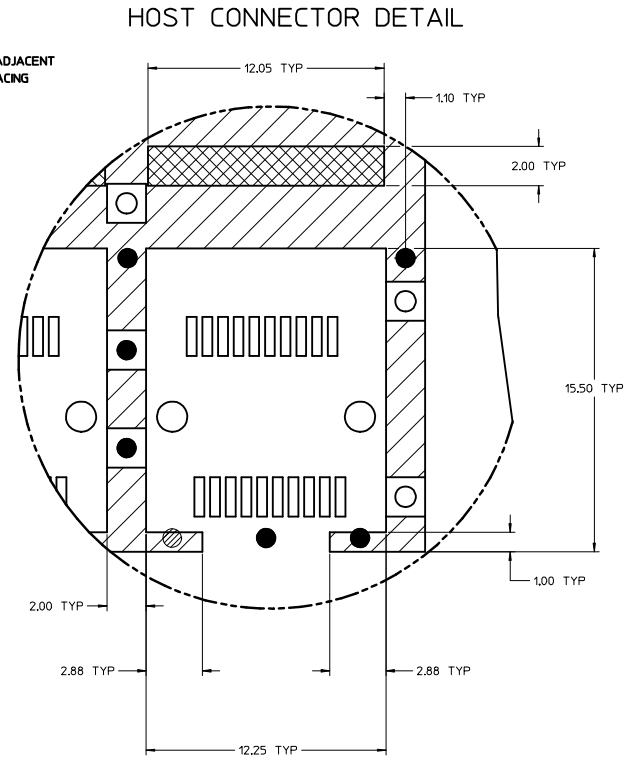

HOST CONNECTOR DETAIL

DETAIL 1
SCALE 8:1

- NOTES:
1. PADS AND VIAS CONNECT TO CHASSIS GROUND (RECOMMENDED PADS TO BE 2.00mm SQUARE)
 2. RECOMMENDED THRU HOLE PLATING INCLUDES HASL, OSP, OR IMMERSION (GOLD, SILVER, OR TIN)
 3. CONNECTOR PAD LAYOUT PER SFP+ MSA WILL ACCOMMODATE MOLEX CONNECTOR SERIES 74441 OR EQUIVALENT
 4. HOLE PATTERN REPEATS FOR EACH PORT, SPACING BETWEEN PORTS IS 14.25mm
 5. MINIMUM PCB THICKNESS FOR SINGLE SIDED USE 157mm [0.062"].

SEE REVISION TABLE EC NO: CPG2016-2974 DRAWN BY: DRWACHENG03 CHKD: APPR: RCHEN08 DATE: 2016/02/04	QUALITY SYMBOLS	GENERAL TOLERANCES (UNLESS SPECIFIED)	DIMENSION STYLE	SCALE	DESIGN UNITS	THIRD ANGLE PROJECTION
	$\nabla=0$	mm INCH	MM ONLY	5:1	METRIC	
	$\nabla=0$	4 PLACES ± --- ± ---	DRAWN BY: RMIKLINSKI DATE: 2011/06/20	TITLE: SFP+ 1X4 CAGE, .120 INCH PRESS FIT, HEAT SINKS, WITH EMI SPRING FINGERS		
	$\nabla=0$	3 PLACES ± --- ± ---	CHECKED BY: MMCKERVEY DATE: 2011/08/26			
	2 PLACES ± 0.15 ± ---	APPROVED BY: KLOYD DATE: 2012/08/14	MATERIAL NO.	DOCUMENT NO.	SHEET NO.	
	1 PLACE ± 0.25 ± ---		SEE SHEET 4	SD-11112-2420	5 OF 10	
	0 PLACE ± ±		THIS DRAWING CONTAINS INFORMATION THAT IS PROPRIETARY TO MOLEX INCORPORATED AND SHOULD NOT BE USED WITHOUT WRITTEN PERMISSION			

PCB LAYOUT FOR BELLY TO BELLY MOUNTING

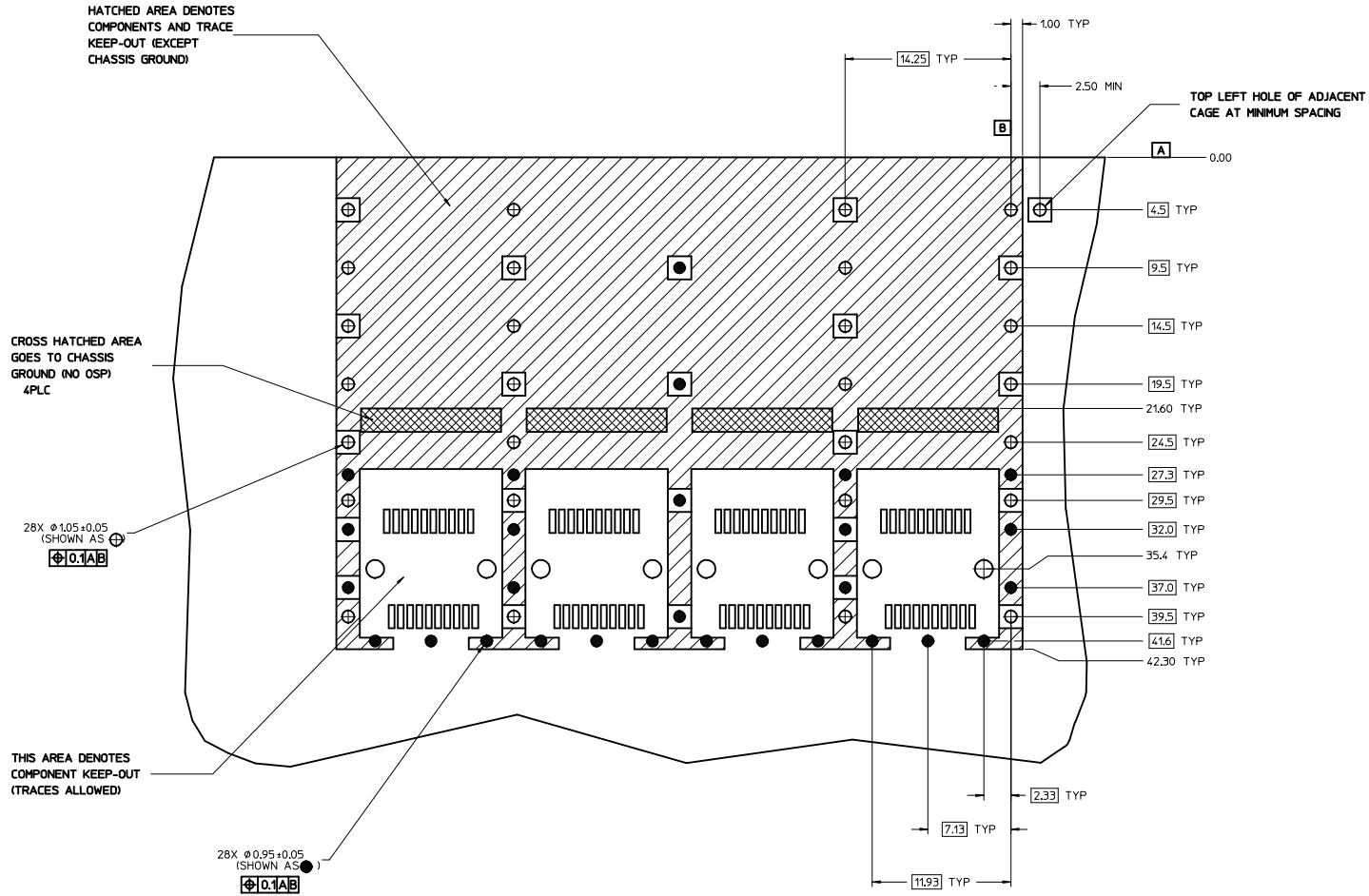

NOTE:
SEE SHEET 5 FOR HOST
CONNECTOR DETAIL

NOTES:

1. PADS AND VIAS CONNECT TO CHASSIS GROUND (RECOMMENDED PADS TO BE 2.00mm SQUARE)
2. RECOMMENDED THRU HOLE PLATING INCLUDES HASL, OSP, OR IMMERSION (GOLD, SILVER, OR TIN)
3. CONNECTOR PAD LAYOUT PER SFP+ MSA WILL ACCOMMODATE MOLEX CONNECTOR SERIES 74441 OR EQUIVALENT
4. HOLE PATTERN REPEATS FOR EACH PORT, SPACING BETWEEN PORTS IS 14.25mm
5. MINIMUM PCB THICKNESS FOR BELLY TO BELLY USE 3.00mm [0.118"].

SEE REVISION TABLE IEC NO: CPG2016-2974 DRAWN: ACHENG03 CHKD: APPR: RCHEN08 REV:	QUALITY SYMBOLS ▽=0 ▽=0 ▽=0	GENERAL TOLERANCES (UNLESS SPECIFIED) mm INCH 4 PLACES ±--- ±--- 3 PLACES ±--- ±--- 2 PLACES ±0.15 ±--- 1 PLACE ±0.25 ±--- 0 PLACE ± ±	DIMENSION STYLE MM ONLY DRAWN BY: RMIKLINSKI CHECKED BY: MCKERVEY APPROVED BY: KLOYD DATE: 2011/06/20 DATE: 2011/08/26 DATE: 2012/08/14	SCALE: 5:1 DESIGN UNITS: METRIC THIRD ANGLE PROJECTION	TITLE: SFP+ 1X4 CAGE, .120 INCH PRESS FIT, HEAT SINKS, WITH EMI SPRING FINGERS molex
	ANGULAR ± 1 ° DRAFT WHERE APPLICABLE MUST REMAIN WITHIN DIMENSIONS	MATERIAL NO.: SEE SHEET 4	DOCUMENT NO.: SD-11112-2420 SHEET NO.: 6 OF 10		
	THIS DRAWING CONTAINS INFORMATION THAT IS PROPRIETARY TO MOLEX INCORPORATED AND SHOULD NOT BE USED WITHOUT WRITTEN PERMISSION				
	INCORPORATED AND SHOULD NOT BE USED WITHOUT WRITTEN PERMISSION				

POLYIMIDE INSULATOR COVERAGE AREA
(APPLIES TO SINGLE SIDED AND BELLY TO BELLY)

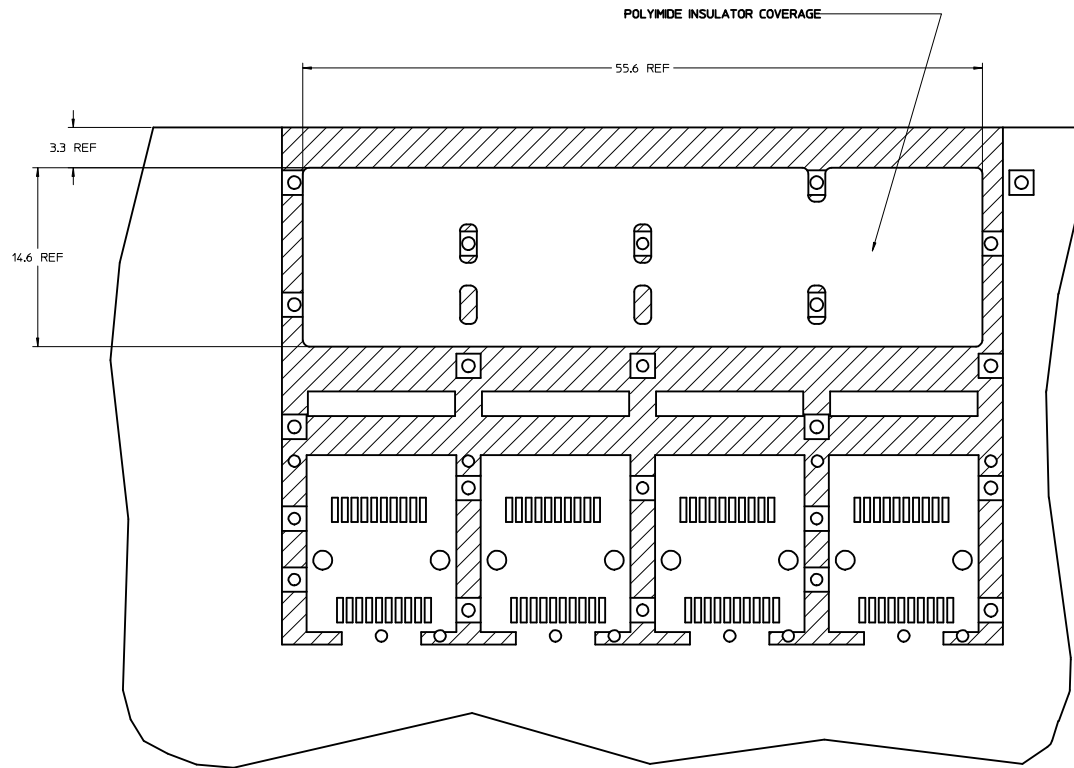

SEE REVISION TABLE EC NO: CPG2016-2974 J CHYD: DRWNAACHENG03 APPROV: CHEN08 2016/02/04	QUALITY SYMBOLS	GENERAL TOLERANCES (UNLESS SPECIFIED)	DIMENSION STYLE	SCALE	DESIGN UNITS	THIRD ANGLE PROJECTION
	▽=0	4 PLACES ± .15	MM ONLY	5:1	METRIC	☉
	▽=0	3 PLACES ± .15				
	▽=0	2 PLACES ± 0.15				
		1 PLACE ± 0.25				
		0 PLACE ±				
		ANGULAR ± 1°				
		DRAFT WHERE APPLICABLE MUST REMAIN WITHIN DIMENSIONS				
			MATERIAL NO.	DOCUMENT NO.		SHEET NO.
			SEE SHEET 4	SD-11112-2420		7 OF 10
			THIS DRAWING CONTAINS INFORMATION THAT IS PROPRIETARY TO MOLEX INCORPORATED AND SHOULD NOT BE USED WITHOUT WRITTEN PERMISSION			

BEZEL AND BOARD POSITION DIMENSIONS FOR SINGLE SIDE MOUNTING
(SPRING FINGER)

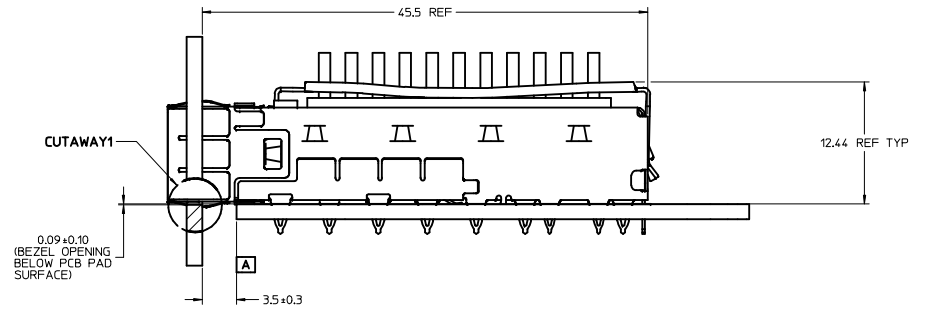
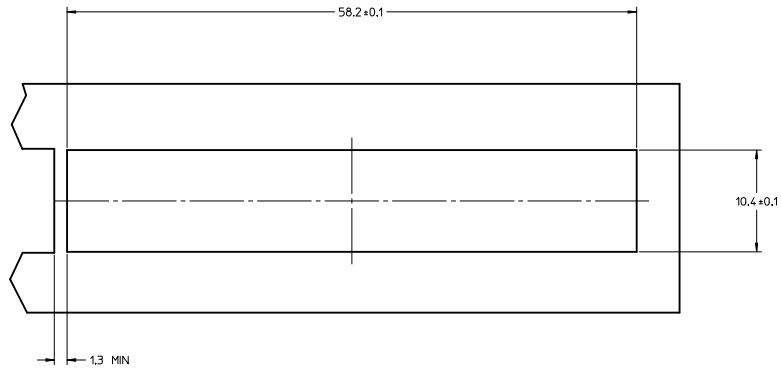

BEZEL AND BOARD POSITION DIMENSIONS FOR BELLY TO BELLY MOUNTING
(SPRING FINGER)

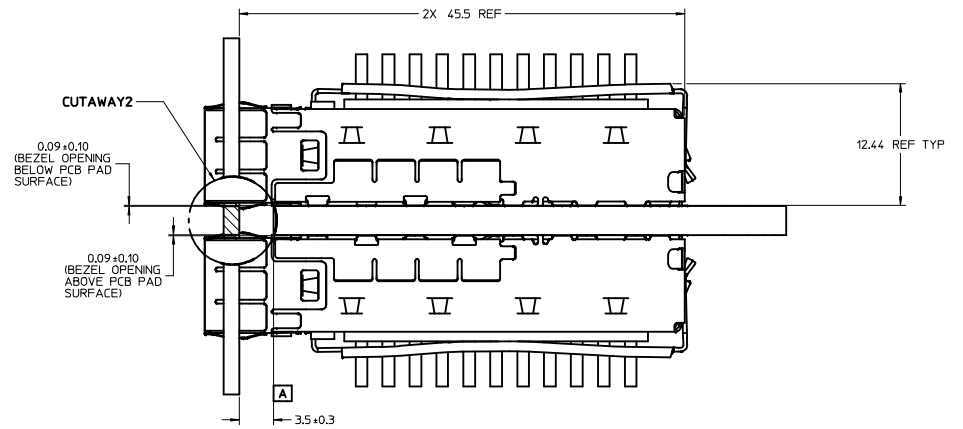
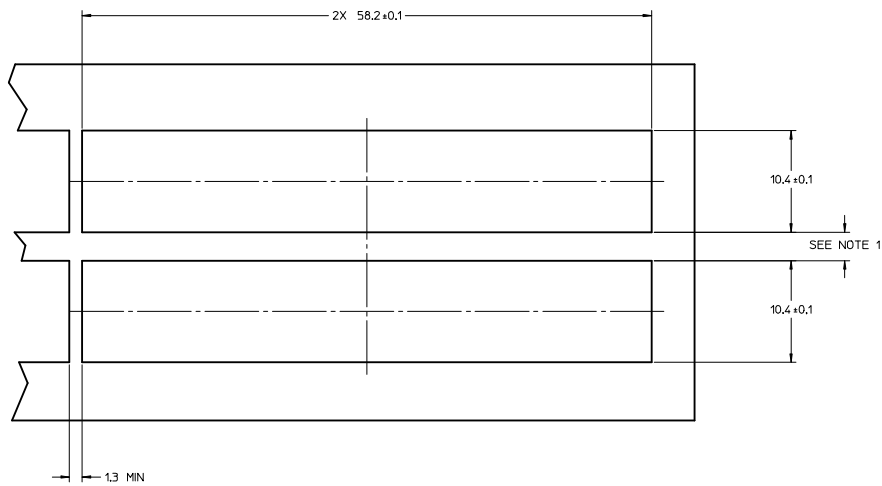

- NOTE:
 1. PCB THICKNESS VARIATION MUST BE CONSIDERED WHEN DETERMINING BEZEL OPENING LOCATION.
 2. CAGE LEG STANDOFF WILL PIERCE BELLY GASKET WHEN PROPERLY PRESSED INTO PCB.

SEE REVISION TABLE EIC NO: CPG2016-2974 DRAWN BY: CHYD APPROVED BY: APPRCHEN08 DATE: 2016/02/04	QUALITY SYMBOLS	GENERAL TOLERANCES (UNLESS SPECIFIED)	DIMENSION STYLE	SCALE	DESIGN UNITS	THIRD ANGLE PROJECTION
	▽=0	mm INCH	MM ONLY	4:1	METRIC	☉
	▽=0	4 PLACES ± ---	DRAWN BY: RMIKLINSKI	DATE: 2011/06/20	TITLE: SFP+ 1X4 CAGE, .120 INCH PRESS FIT, HEAT SINKS, WITH EMI SPRING FINGERS	
	▽=0	3 PLACES ± 0.15	CHECKED BY: MMCKERVEY	DATE: 2011/08/26	MATERIAL NO. SEE SHEET 4	
▽=0	2 PLACES ± 0.25	1 PLACE ± ---	APPROVED BY: KLLOYD	DATE: 2012/08/14	DOCUMENT NO. SD-11112-2420	
	0 PLACE ± ---	ANGULAR ± 1 °	DRAFT WHERE APPLICABLE MUST REMAIN WITHIN DIMENSIONS		SHEET NO. 8 OF 10	
THIS DRAWING CONTAINS INFORMATION THAT IS PROPRIETARY TO MOLEX INCORPORATED AND SHOULD NOT BE USED WITHOUT WRITTEN PERMISSION						

DATE	REV	DESCRIPTION
2011/06/21	1	INITIAL RELEASE
2011/06/29	A	UPDATED THE CAGE TOP TO INCLUDE HOLES FOR LIGHTPIPES.
2012/03/20	B	REVISED NOTES, HANGED HEATSINK HEIGHT FROM 8.63 TO 6.5, TABULARIZED PCI, SAN, AND NETWORKING, ADDED HEATSINK HEIGHT WITH MODULE INSERTED [SHT1]. MOVED EXPLODED VIEW TO SHT2. CHANGED OTHER SHEET NUMBER ACCORDINGLY. REMOVED NOTE 6 AND MOVED TO SHEET 2.
2012/07/31	C	HIDE HEATSINK CLIP FROM TOP VIEW, CHANGED DIM 49.0 TO 49.3 AND ADDED 'SEE TABLE ON SHEET 2' TO ANNOTATION ON VIEW BOTTOM 3, ADDED MODEL NOTATION IN TOP CORNER ON SHEET 1, ADDED KAPTON TAPE MODEL TO EXPLODED VIEW ON SHEET 2, EXPANDED P/N TABLE ON SHEET 2 TO INCLUDE HEAT SINK DIMS AND KAPTON TAPE OPTIONS, REMOVED DIM 'B' FROM SHEET 2, REWORDED ANNOTATIONS FOR CORRECT ORIENTATION ON SHEET 5.
2012/08/31	D	REMOVED HEATSINKS AND CLIPS FROM ALL VIEWS ON SHEET 1, SEPERATED HEATSINKS TO SEPERATE VIEWS ON SHEET 2 AND REMOVED P/N FROM TABLES, ADDED NEW SHEET 3 WITH VIEWS AND P/N TABLES FOR NO HEATSINK, AND PINFIELD OR LATERAL FIN HEATSINKS, MOVED DIM '0.23 TYP' ON SHEET 6. ADDED ISO VIEWS AND PART NUMBER TABLES FOR WIDE GAP HEATSINKS TO SHEET 2 AND SHEET 3. ADDED TOP VIEWS OF SINGLE AND BELLY TO BELLY PCB TO SHEET SIX TO SHOW POLYIMIDE COVERAGE AND DIMENSIONS.
2013/02/20	E	<ol style="list-style-type: none"> 1. CHANGED BASE CAGE VIEWS ON SHEET 1 FROM 111112-0432 TO 747540420. ADDED TYP TO DIMENSION 3.05 REF ON SIDE VIEW. MOVED DIMENSIONS '10.85 REF' TO F14, '14.0 ±0.1' TO D17, '56.75 REF' TO F17, '58.65 REF' TO G17. ADDED DIMENSION '9.98 REF' @E7. CHANGED DIMENSION 49.03 TO 49.0 @ J14. ADDED BACK VIEW, @E3. REMOVED BELLY ISO VIEW AND ROTATED TOP ISO VIEW & MOVED TO J7. MOVED PCB MIN THICKNESS FROM NOTE 2 TO RESPECTIVE PCB LAYOUT SHEETS. REMOVED INSERTION FORCE FROM NOTE 2. ADDED APPLICATION NOTE @H10. UPDATED P/N DATE CODE PRINTING CALLOUT ON SIDE VIEW. UPDATED 3D MODEL P/N @M20. ADDED EMI SPRING FINGERS NOTE @H8. (SHEET 1) 2. MOVED POLYIMIDE BELLY ISO VIEW TO E9 AND ADDED REAR LEG & UNDER BELLY SPRING FINGER IDENTIFIERS. ADDED UNDERBELLY GASKET ISO VIEW @E3. ADDED TOP VIEW, @ J17. REMOVED CAGES FROM HEATSINK VIEWS. ADDED REAR LEG OPTIONS, @B16. ADDED TITLE FOR TABLES THAT READS OVERALL HEATSINK HEIGHT. ADDED POLYIMIDE INSULATOR & # OF REAR LEGS PER PORT COLUMNS TO TABLES. (SHEET 2) 3. ADDED PN'S 747500420, -0422, -0423 & 1111110420 AND UPDATED TABLES, ADDING ISO VIEWS @F18 & F13. ADDED P/N NOTE FOR EACH CAGE SHOWN. (SHEET 3) 4. ADDED NOTE 5, (SHEET 4 & 5). REMOVED UNNECESSARY CAGE TO PCB CONTACT PADS FROM BELLY TO BELLY LAYOUT. ADDED TYP TO ALL DIMENSIONS (SHEET 4 & 5). ADDED DIAMETER DIMENSION 0.95±0.05 X4 WITH NOTES 'SHOWN AS...' (SHEET 4). FIXED BOX TO NOT INCLUDE TYP. ADDED HOLES @E17, @E15, @E13, & E11 (SHEET 4). REMOVED PAD @F13 (SHEET 5). 5. REMOVED BELLY TO BELLY VIEW AND CENTERED & INCREASED SCALE OF SINGLE SIDED VIEW. (SHEET 6) 6. REMOVED 'SEE NOTE 1' FROM DIMENSION '10.4 ±0.1', @E12 & D12. ADDED 'SEE NOTE 1' BEZEL OPENING PITCH, @E12. ADDED CENTER LINES TO BEZEL OPENINGS. REMOVED CUTAWAY 7 & 8 FROM SIDE VIEWS. RENAMED CUTAWAY2 TO 1 AND 4 TO 2. REMOVED 'SIZE, AND' FROM NOTE 1. ADDED DIMENSION 12.44 REF TYP TO BOTH SIDE VIEWS. REMOVED DIMENSION 9.98 TYP @E4 & J4. (SHEET 7)
2013/09/06	F	ADDED PN'S 747540426. (SHEET 3)
2013/10/14	G	<ol style="list-style-type: none"> 1. CHANGED THE WORD 'WILL' TO 'MAY' ON NOTE 4. MOVED DATE CODE FROM SIDE OF CAGE TO BACK OF CAGE, ADDED NOTE AT E5 TO LIST THE SERIES NUMBERS THAT WILL HAVE THE DATE CODE INTHIS LOCATION. ADDED 0.70 MAX(BENDING TAB TO BOTTOM SURFACE OF BASE) AT E13. (SHEET 1) 2. REMOVED zSFP+ CAGE VIEW FROM SHEET AT E5, ADDED SIDE VIEW OF CAGE TO SHOW WHERE THE DATE CODE WILL BE ON ALL 111112 SERIES CAGES. (SHEET 2) 3. ADDED NEW SHEET 3 WITH GEN 1 AND GEN 2 zSFP+ OPTIONS. THE PREVIOUS SHEETS FROM SHEET 3 TO SHEET 8 ALL INCREASE BY 1 NUMBER. 4. ADDED P/N 747540427 TO TABLE AT D20 AND ADDED ISO VIEW AND TABLE FOR 1001140420 AT E3 ON SHEET 4.

SEE REVISION TABLE EC NO: CPG2016-2974 DRAWN BY: CHEN03 CHYK: APPR:RCHEN03 2016/02/04	QUALITY SYMBOLS	GENERAL TOLERANCES (UNLESS SPECIFIED)	DIMENSION STYLE	SCALE	DESIGN UNITS	THIRD ANGLE PROJECTION
	▽=0	mm INCH	MM ONLY	1:1	METRIC	☉
	▽=0	4 PLACES ± --- ± ---	DRAWN BY DATE	RM IKLINSKI 2011/06/20	TITLE	
	▽=0	3 PLACES ± --- ± ---	CHECKED BY DATE	MCKERVEY 2011/08/26	SFP+ 1X4 CAGE, .120 INCH PRESS FIT, HEAT SINKS WITH EMI SPRING FINGERS	
	ANGULAR ± 1 °	DRAFT WHERE APPLICABLE MUST REMAIN WITHIN DIMENSIONS	APPROVED BY DATE	KLLOYD 2012/08/14	MATERIAL NO.	DOCUMENT NO.
			SEE SHEET 4			
			THIS DRAWING CONTAINS INFORMATION THAT IS PROPRIETARY TO MOLEX INCORPORATED AND SHOULD NOT BE USED WITHOUT WRITTEN PERMISSION			SHEET NO. 9 OF 10

DATE	REV	DESCRIPTION
2014/09/24	H	1. ADDED 74754-0426 PLATING SPEC. [SHEET 4] 2. ADDED P/N 74754-0464. [SHEET 4]
2015/08/26	I	1. SHEET 3 : ADDED NOTE 2 2. SHEET 2: J13 : ADDED NEW VERTICAL FIN HEATSINK ISOVIEW 3. SHEET 4: H10 : ADDED (*) FOR LOW COST IN NOTE 4. SHEET 4: I10 : ADDED PART NO. 111112-5421 ON P/N TABLE 5. SHEET 5: K18 : ADDED PART NO. 111112-6421 ISOVIEW 6. SHEET 6: G20 : CHANGED $\phi 1.05+/-0.05$ X14 TO $\phi 14X 1.05+/-0.05$ 7. SHEET 6: D19 : CHANGED $\phi 0.95+/-0.05$ X20 TO $\phi 20X 0.95+/-0.05$ 8. SHEET 6: D14 : CHANGED $\phi 0.95+/-0.05$ X4 TO $\phi 4X 0.95+/-0.05$ 9. SHEET 7: G18 : CHANGED $\phi 1.05+/-0.05$ X28 TO $\phi 28X 1.05+/-0.05$ 10. SHEET 7: C16 : CHANGED $\phi 0.95+/-0.05$ X28 TO $\phi 28X 0.95+/-0.05$ 11. SHEET 9: ADDED NOTE 2 MODIFIED PCB LAYOUT PER SFF-8433 12. SHEET 6: G20 : CHANGED TURE POSITION OF PCB HOLES FORM 0.05 TO 0.1 C19 : CHANGED TURE POSITION OF PCB HOLES FORM 0.05 TO 0.1 C14 : CHANGED TURE POSITION OF PCB HOLES FORM 0.05 TO 0.1 13. SHEET 7 : F18 : CHANGED TURE POSITION OF PCB HOLES FORM 0.05 TO 0.1 C16 : CHANGED TURE POSITION OF PCB HOLES FORM 0.05 TO 0.1
2016/02/02	J	1. SHEET 3 & 4: REMOVE 1111110420

SEE REVISION TABLE EC NO: CPG2016-2974 J DRAWN: ACHENG03 2016/02/02 CHKD: APPR: RCHEN08 2016/02/04 REV DESCRIPTION	QUALITY SYMBOLS	GENERAL TOLERANCES (UNLESS SPECIFIED)	DIMENSION STYLE	SCALE	DESIGN UNITS	THIRD ANGLE PROJECTION	
	$\nabla=0$	4 PLACES \pm mm \pm INCH	MM ONLY		METRIC		
	$\nabla=0$	3 PLACES ± 0.15	DRAWN BY: RMIKLINSKI DATE: 2011/06/20	TITLE: SFP+ 1X4 CAGE, .120 INCH PRESS FIT, HEAT SINKS, WITH EMI SPRING FINGERS			
	$\nabla=0$	2 PLACES ± 0.25	CHECKED BY: MMCKERVEY DATE: 2011/08/26				
	1 PLACE \pm	APPROVED BY: KLLOYD DATE: 2012/08/14					
	0 PLACE	ANGULAR $\pm 1^\circ$	MATERIAL NO.	DOCUMENT NO.	SHEET NO.		
		DRAFT WHERE APPLICABLE MUST REMAIN WITHIN DIMENSIONS	SEE SHEET 4	SD-11112-2420	10 OF 10		
			THIS DRAWING CONTAINS INFORMATION THAT IS PROPRIETARY TO MOLEX INCORPORATED AND SHOULD NOT BE USED WITHOUT WRITTEN PERMISSION				