

PARTS TO BE PACK WITH CAP (12 CKT SHOWN)

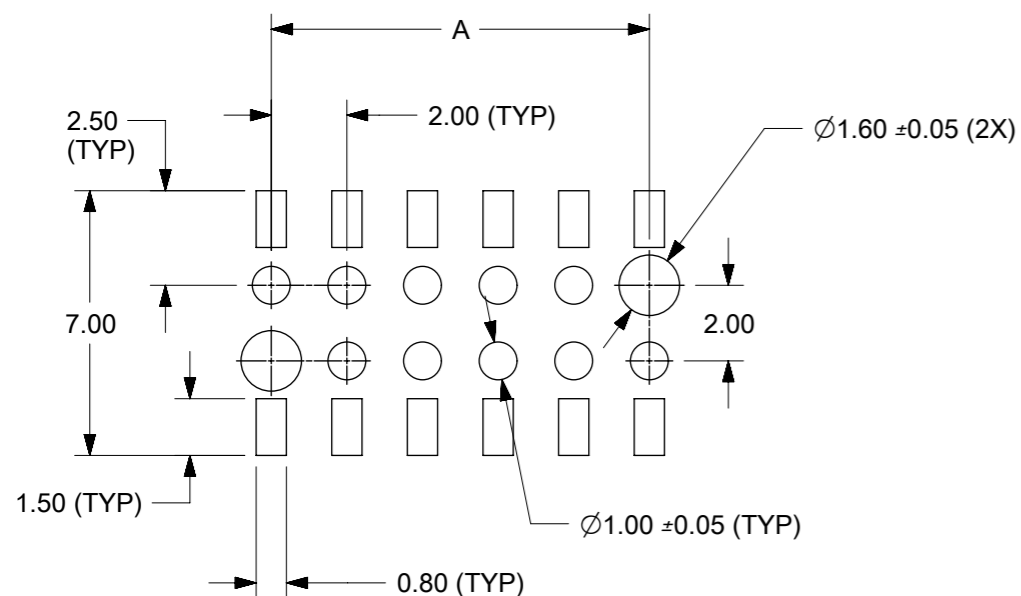

RECOMMENDED SOLDER PAD DESIGN

CKT. SIZE	DIM. A	DIM. B
4	2.00	4.00
6	4.00	6.00
8	6.00	8.00
10	8.00	10.00
12	10.00	12.00
14	12.00	14.00
16	14.00	16.00
18	16.00	18.00
20	18.00	20.00
22	20.00	22.00
24	22.00	24.00
26	24.00	26.00
28	26.00	28.00
30	28.00	30.00
32	30.00	32.00
34	32.00	34.00
36	34.00	36.00
38	36.00	38.00
40	38.00	40.00
42	40.00	42.00
44	42.00	44.00

PART NO. LEGEND

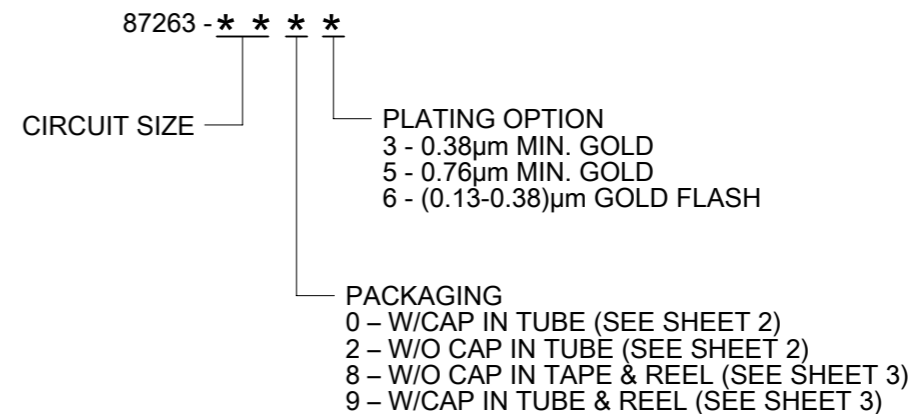

NOTES:

- FOR ILLUSTRATION PURPOSES, DRAWINGS SHOWS PART WITH 12 CIRCUIT SIZE
- PLATING:  
POST PLATING - SELECTIVE GOLD (SEE LEGEND) AT CONTACT AREA, AND 1.27µm MIN. SELECTIVE TIN AT SOLDER AREA BOTH OVER 1.27µm MIN. NICKEL OVERALL
- CO-PLANARITY OF P.C TAIL TO BE MEASURED BY RESTING THE PART ON A FLAT GAGE SURFACE.
- PRODUCT SPECIFICATION PS-87263 APPLIES
- CAP: HIGH TEMPERATURE THERMOPLASTIC, UL RATED 94V-0, SUITABLE FOR SURFACE-MOUNT SOLDERING PROCESS.  
COLOR: BLACK
- POSITION OF CAP TO BE CENTRAL WITH RESPECT TO DIMENSION "A"
- CONTACT FACTORY FOR DETAIL ON THIS PART NO.
- PARTS SHALL BE PACKED IN MOISTURE BARRIER BAG
- P/N 87263-3686 TO BE PACKED IN EMBOSSED TAPE TYPE B1
- PACKAGING SPECIFICATION FOR TAPE AND REEL: PK-87263-300

THIS DRAWING CONTAINS INFORMATION THAT IS PROPRIETARY TO MOLEX ELECTRONIC TECHNOLOGIES, LLC AND SHOULD NOT BE USED WITHOUT WRITTEN PERMISSION									
DIMENSION UNITS		SCALE		CURRENT REV DESC: MIGRATED TO ECTR					
mm		NTS							
GENERAL TOLERANCES (UNLESS SPECIFIED)									
		MM	INCH	<b>EC NO:</b> 605777 <b>DRWN:</b> RMV02 2018/02/02 <b>CHK'D:</b> GJEEVANSURES 2018/10/11 <b>APPR:</b> ISHWARG 2018/10/11 <b>INITIAL REVISION:</b> <b>DRWN:</b> JDK 1991/01/11 <b>APPR:</b> MLONG 2010/03/19					
4 PLACES	±	±	±						
3 PLACES	±	±	±						
2 PLACES	±	0.2	±						
1 PLACE	±	±	±						
ANGULAR TOL		± 3.0°		<b>DOCUMENT NUMBER</b> SD-87263-XX2X <b>DOC TYPE</b> PSD <b>DOC PART</b> 001 <b>REVISION</b> J12					
DRAFT WHERE APPLICABLE MUST REMAIN WITHIN DIMENSIONS		THIRD ANGLE PROJECTION		DRAWING		SERIES		MATERIAL NUMBER	
				A3-SIZE		87263		SEE TABLE	
						GENERAL MARKET		SHEET NUMBER 1 OF 4	

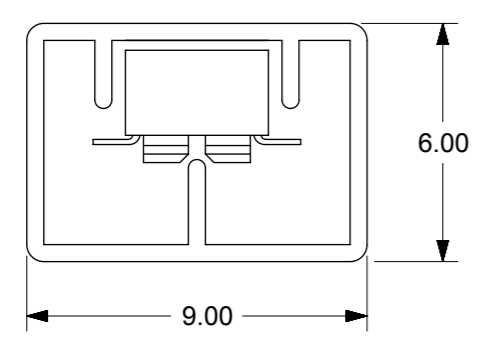
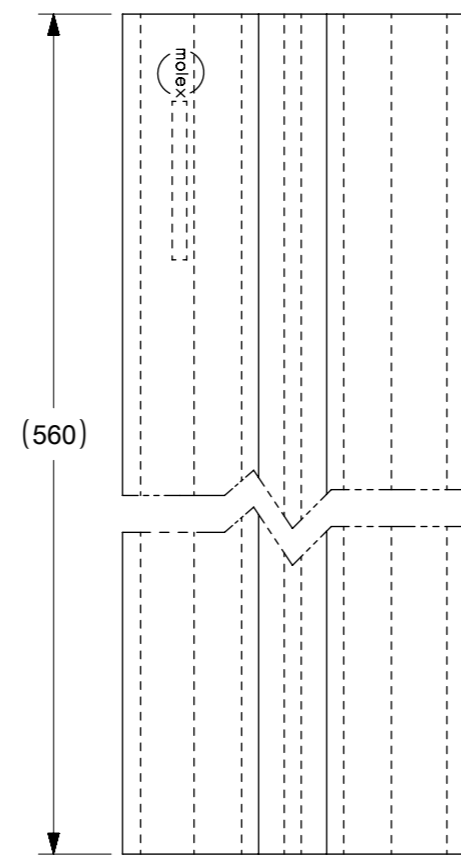
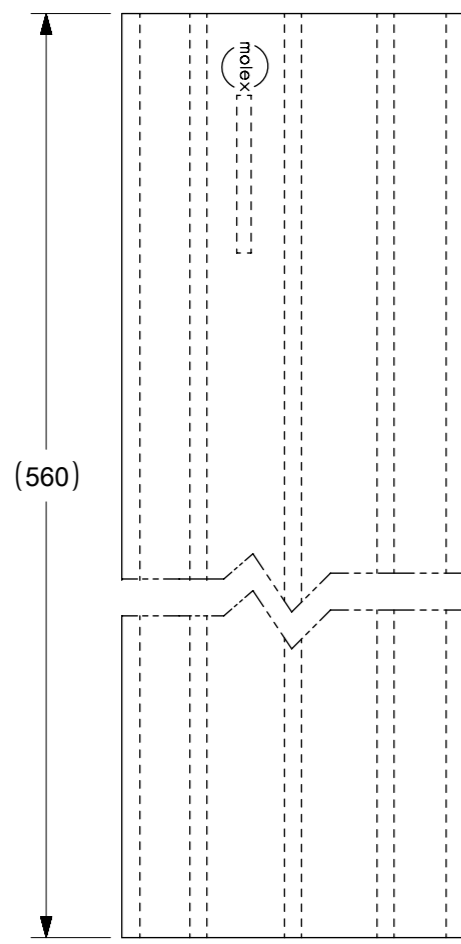

P/N 87263-\*\*-2\*

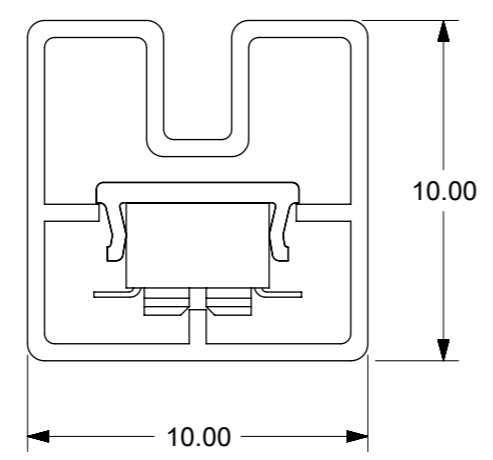

P/N 87263-\*\*-0\*

CKT. SIZE	PART NO. FOR PARTS WITHOUT CAP	PART NO. FOR PARTS WITH CAP
4	87263-042*	87263-040*
6	87263-062*	87263-060*
8	87263-082*	87263-080*
10	87263-102*	87263-100*
12	87263-122*	87263-120*
14	87263-142*	87263-140*
16	87263-162*	87263-160*
18	87263-182*	87263-180*
20	87263-202*	87263-200*
22	87263-222*	87263-220*
24	87263-242*	87263-240*
26	87263-262*	87263-260*
28	87263-282*	87263-280*
30	87263-302*	87263-300*
32	87263-322*	87263-320*
34	87263-342*	87263-340*
36	87263-362*	87263-360*
38	87263-382*	87263-380*
40	87263-402*	87263-400*
42	87263-422*	87263-420*
44	△ 87263-442*	87263-440*

THIS DRAWING CONTAINS INFORMATION THAT IS PROPRIETARY TO MOLEX ELECTRONIC TECHNOLOGIES, LLC AND SHOULD NOT BE USED WITHOUT WRITTEN PERMISSION

DIMENSION UNITS		SCALE		CURRENT REV DESC: MIGRATED TO ECTR		<b>molex</b>			
mm		NTS							
GENERAL TOLERANCES (UNLESS SPECIFIED)						MGRID, B/ENTRY RECEPT. 2.80MM HT. W/LOC. PEGS W/CAP, SMT			
		MM	INCH						
4 PLACES	±		±			PRODUCT CUSTOMER DRAWING			
3 PLACES	±		±						
2 PLACES	±	0.2	±			DOCUMENT NUMBER: SD-87263-XX2X   DOC TYPE: PSD   DOC PART: 001   REVISION: J12			
1 PLACE	±		±						
0 PLACES	±		±			MATERIAL NUMBER: SEE TABLE   CUSTOMER: GENERAL MARKET   SHEET NUMBER: 2 OF 4			
ANGULAR TOL		± 3.0°							
DRAFT WHERE APPLICABLE MUST REMAIN WITHIN DIMENSIONS		THIRD ANGLE PROJECTION		DRAWING	SERIES				
				A3-SIZE	87263				

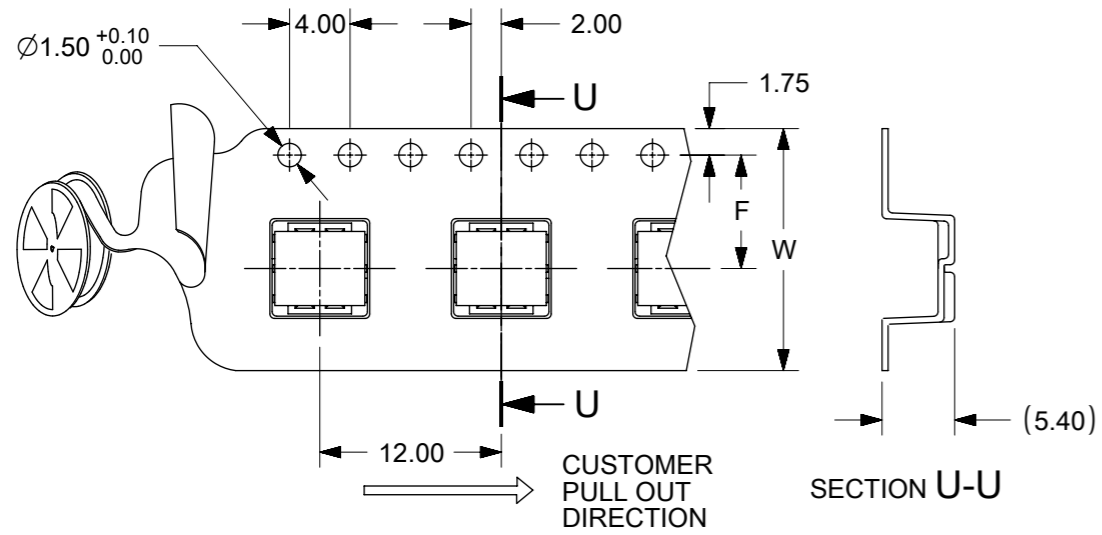

PART NO. 87263-\*\*9\* (CKTS 04 TO 16)  
SINGLE SPROCKET HOLE T/REEL - TYPE A

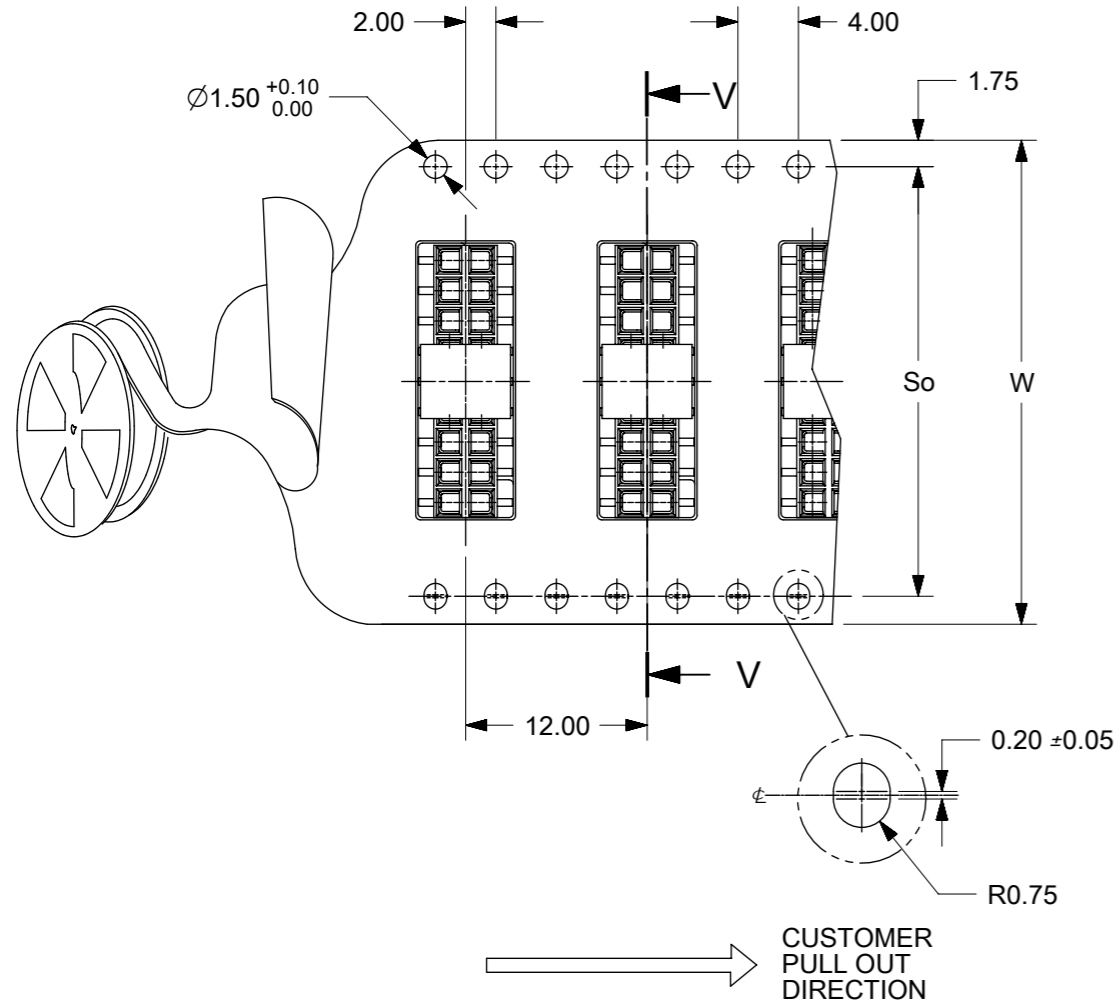

PART NO. 87263-\*\*9\* (CKTS 18 TO 40)  
DOUBLE SPROCKET HOLE T/REEL - TYPE B

PART NO. FOR PARTS WITHOUT CAP IN T/REEL	PART NO. FOR PARTS WITH CAP IN T/REEL	CKT. SIZE	F	So	W	T/REEL TYPE
87263-048*	87263-049*	4	11.5	----	24	A
87263-068*	87263-069*	6	11.5	----	24	
87263-088*	87263-089*	8	11.5	----	24	
87263-108*	87263-109*	10	11.5	----	24	
87263-128*	87263-129*	12	11.5	----	24	
87263-148*	87263-149*	14	11.5	----	24	
87263-168*	87263-169*	16	11.5	----	24	
87263-188*	87263-189*	18	14.2	28.4	32	
87263-208*	87263-209*	20	20.2	40.4	44	
87263-228*	87263-229*	22	20.2	40.4	44	
87263-248*	87263-249*	24	20.2	40.4	44	
87263-268*	87263-269*	26	20.2	40.4	44	
87263-288*	87263-289*	28	20.2	40.4	44	
87263-308*	87263-309*	30	20.2	40.4	44	
87263-328*	87263-329*	32	26.2	52.4	56	
87263-348*	87263-349*	34	----	----	----	
$\triangle_9$ 87263-368*	87263-369*	36	26.2	52.4	56	
87263-388*	87263-389*	38	----	----	----	
87263-408*	87263-409*	40	----	----	----	
$\triangle_9$ 87263-3686	----	36	26.2	52.4	56	B1

NOTES:  
1. LEADER AND TRAILER TAPE

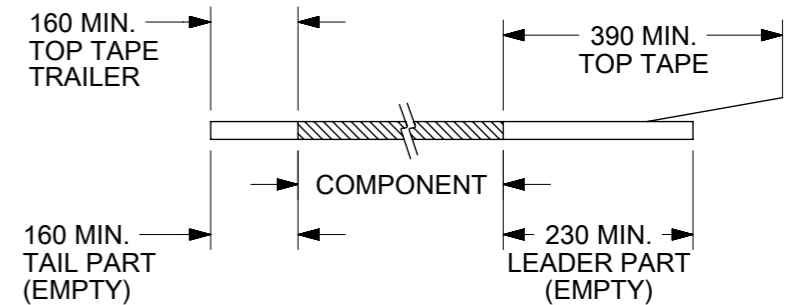

2. PEELING OFF FORCE OF THE TOP TAPE: 20-80gf.  
(PEELING DIRECTION AS SHOWN IN FOLLOWING FIGURE)

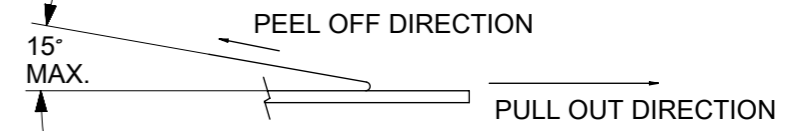

3. PACKAGING STANDARD IS AS PER EIA-481.  
4. TAPE & REEL QUANTITY: EMBOSSED TYPE A & B = 1000PCS/REEL  
EMBOSSED TYPE B1 = 900PCS/REEL  
5. THE TAPE IS TREATED FOR ANTI-STATIC.

THIS DRAWING CONTAINS INFORMATION THAT IS PROPRIETARY TO MOLEX ELECTRONIC TECHNOLOGIES, LLC AND SHOULD NOT BE USED WITHOUT WRITTEN PERMISSION		CURRENT REV DESC: MIGRATED TO ECTR			
DIMENSION UNITS: mm		SCALE: NTS			
GENERAL TOLERANCES (UNLESS SPECIFIED)		EC NO: 605777		MGRID, B/ENTRY RECEIPT. 2.80MM HT. W/LOC. PEGS W/CAP, SMT	
4 PLACES	±	DRWN: RMV02	2018/02/02	PRODUCT CUSTOMER DRAWING	
3 PLACES	±	CHK'D: GJEEVANSURES	2018/10/11	DOCUMENT NUMBER	
2 PLACES	± 0.2	APPR: ISHWARG	2018/10/11	DOC TYPE	
1 PLACE	±	INITIAL REVISION:		DOC PART	
0 PLACES	±	DRWN: JDK	1991/01/11	REVISION	
ANGULAR TOL ± 3.0°		APPR: MLONG	2010/03/19	SD-87263-XX2X	
DRAFT WHERE APPLICABLE MUST REMAIN WITHIN DIMENSIONS		THIRD ANGLE PROJECTION	DRAWING	SERIES	MATERIAL NUMBER
			A3-SIZE	87263	SEE TABLE
					CUSTOMER
					GENERAL MARKET
					SHEET NUMBER
					3 OF 4

# T/REEL TYPE B1

PART WITHOUT CAP IN T&R	CKT SIZE	Bo	Ko	Ao
△ 87263-3686	36	36.40	5.00	6.60

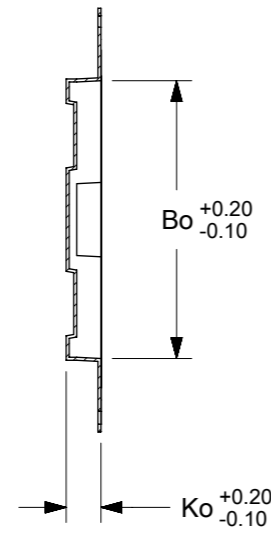

SECTION A-A

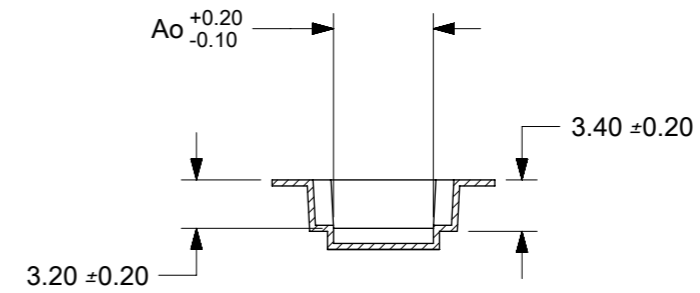
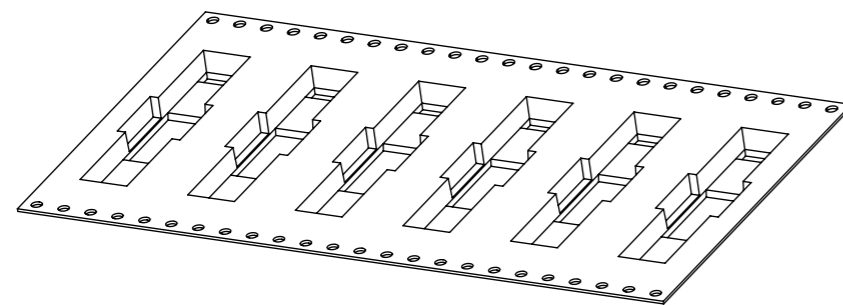
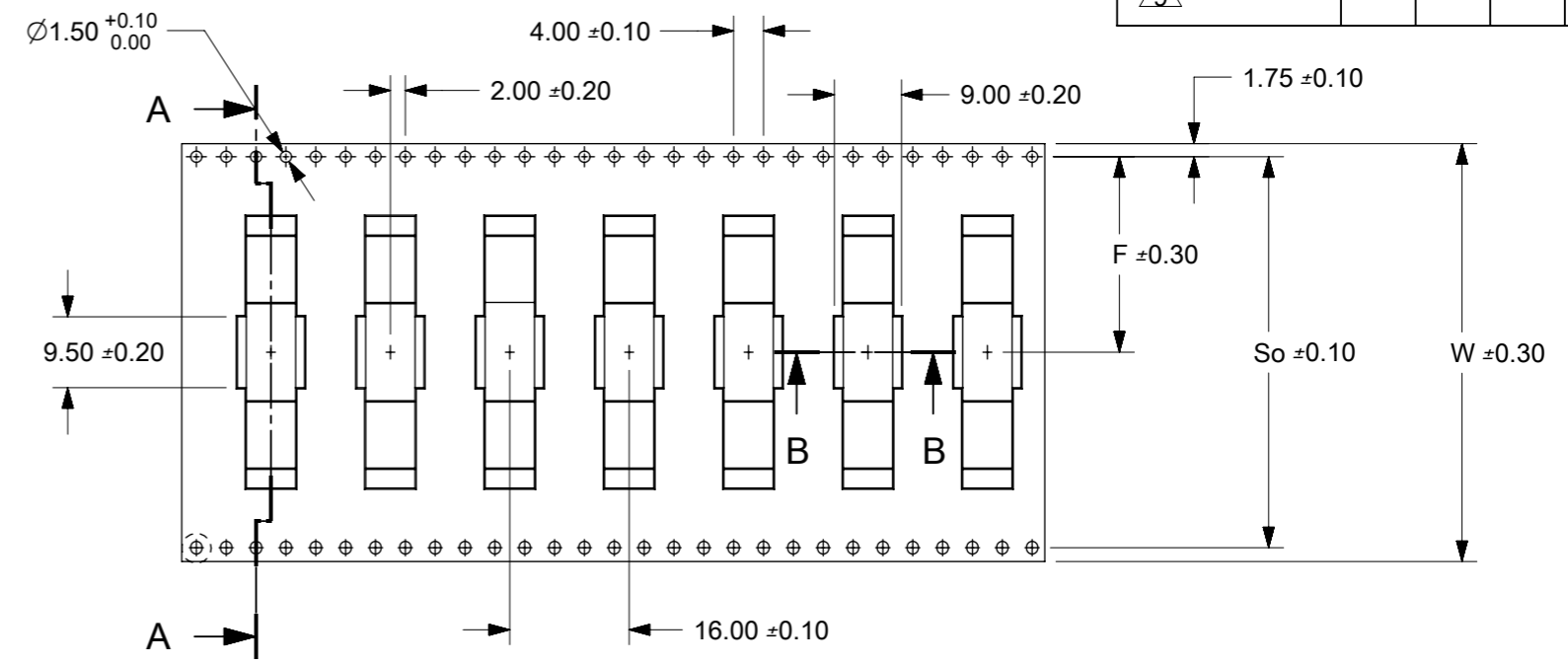

SECTION B-B

THIS DRAWING CONTAINS INFORMATION THAT IS PROPRIETARY TO MOLEX ELECTRONIC TECHNOLOGIES, LLC AND SHOULD NOT BE USED WITHOUT WRITTEN PERMISSION									
DIMENSION UNITS		SCALE		CURRENT REV DESC: MIGRATED TO ECTR					
mm		NTS		<div style="text-align: center; font-size: 24pt; font-weight: bold;">molex</div> <p>MGRID, B/ENTRY RECEIPT. 2.80MM HT. W/LC. PEGS W/CAP, SMT</p>					
GENERAL TOLERANCES (UNLESS SPECIFIED)									
		MM	INCH	EC NO: 605777 DRWN: RMV02      2018/02/02 CHK'D: GJEEVANSURES      2018/10/11 APPR: ISHWARG      2018/10/11					
4 PLACES	±			PRODUCT CUSTOMER DRAWING					
3 PLACES	±			DOCUMENT NUMBER					
2 PLACES	±	0.2		SD-87263-XX2X					
1 PLACE	±			DOC TYPE					
0 PLACES	±			PSD					
ANGULAR TOL		± 3.0°		DOC PART					
				001					
DRAFT WHERE APPLICABLE MUST REMAIN WITHIN DIMENSIONS		THIRD ANGLE PROJECTION		DRAWING		SERIES		REVISION	
				A3-SIZE		87263		J12	
				MATERIAL NUMBER		CUSTOMER		SHEET NUMBER	
				SEE TABLE		GENERAL MARKET		4 OF 4	

DOCUMENT STATUS	P1	RELEASE DATE	2018/10/11	12:17:35
-----------------	----	--------------	------------	----------