

NOTE:

1. MATERIAL:
HSG & CAP - NYLON, GLASS-FILLED, UL 94V-0, COLOUR BLACK
PIN - 0.50 SQ. PHOSPHOR BRONZE
2. PLATING OPTION:
1: 0.38µm MIN. GOLD PLATE AT CONTACT AREA, TIN PLATE AT SOLDER AREA, BOTH OVER NICKEL UNDERPLATE
2: 0.05-0.25µm MIN. GOLD PLATE AT CONTACT AREA, TIN PLATE AT SOLDER AREA, BOTH OVER NICKEL UNDERPLATE
3. PIN PUSHOUT FORCE: 1kg MIN. IN EITHER DIRECTION.
4. PRODUCT SPEC PS-87761-100 APPLIES.
5. BEND DEPRESSION IS ACCEPTABLE SO LONG AS IT DOES NOT AFFECT THE OVERALL COPLANARITY OF TAIL.
6. COPLANARITY IS TO BE MEASURED BY RESTING THE SOLDER TAIL ON A GAUGE SURFACE.
7. CAP TO BE LOCATED AS CENTRAL OF PART AS POSSIBLE
TOP SURFACE OF CAP TO BE FLAT FOR THE PURPOSE OF PICK & PLACE BY VACCUM SUCTION NOZZLE.
8. FOR ILLUSTRATION PURPOSES, 10CKT IS SHOWN (WITH TAPE & REEL ON 2ND SHEET). SHT 3 INDICATES THE TYPE OF EMBOSSED USED IN GENERAL.
9. TUBE LENGTH IS 560MM REF STANDARD.
10. RECOMMENDED PCB BOARD THK IS 1.60±0.10 MM.

THIS DRAWING CONTAINS INFORMATION THAT IS PROPRIETARY TO MOLEX ELECTRONIC TECHNOLOGIES, LLC AND SHOULD NOT BE USED WITHOUT WRITTEN PERMISSION		CURRENT REV DESC:		molex	
DIMENSION UNITS	SCALE	EC NO: 699037			
mm	NTS	DRWN: DANUSA 2021/11/26		MGRID, 2MM DUAL ROW HDR WITH PEG, SMT	
GENERAL TOLERANCES (UNLESS SPECIFIED)		CHK'D: DANUSA 2022/03/10		PRODUCT CUSTOMER DRAWING	
		APPR: MRAMAKRISHNA 2022/03/10		DOCUMENT NUMBER	
4 PLACES	±	INITIAL REVISION:		SD-87759-208	
3 PLACES	±	DRWN: KSEE 2003/12/22		DOC TYPE	DOC PART
2 PLACES	± 0.2	APPR: MLONG 2009/12/17		PSD	001
1 PLACE	±	ANGULAR TOL ± 3.0°		REVISION	D7
0 PLACES	±	DRAFT WHERE APPLICABLE MUST REMAIN WITHIN DIMENSIONS		MATERIAL NUMBER	CUSTOMER
		THIRD ANGLE PROJECTION	DRAWING	SERIES	SHEET NUMBER
			A3-SIZE	87759	1 OF 4
			SEE TABLE	GENERAL MARKET	

CAP TYPE	D
C1	5.20
C2	4.60

EMBOSED TYPE "A"
PART WITH CAP IN TAPE & REEL ORIENTATION

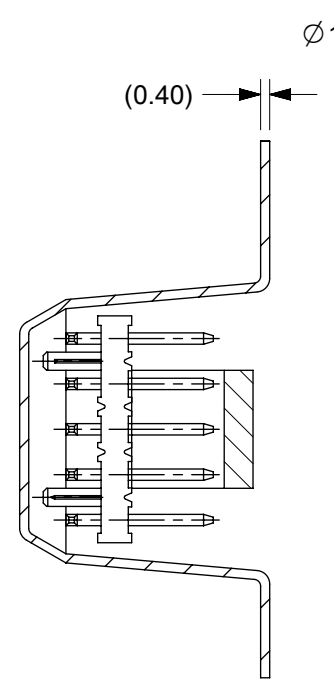
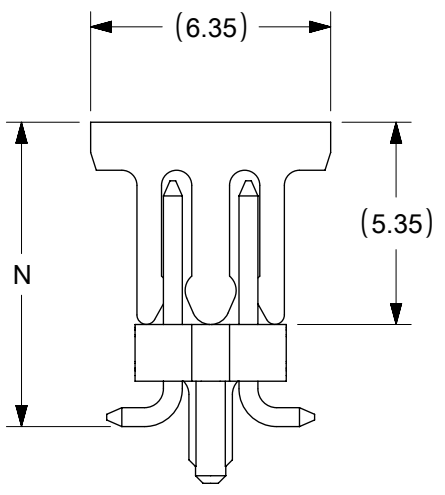
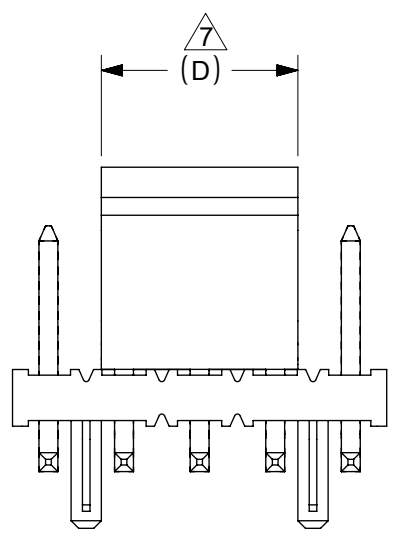

SECTION Y-Y

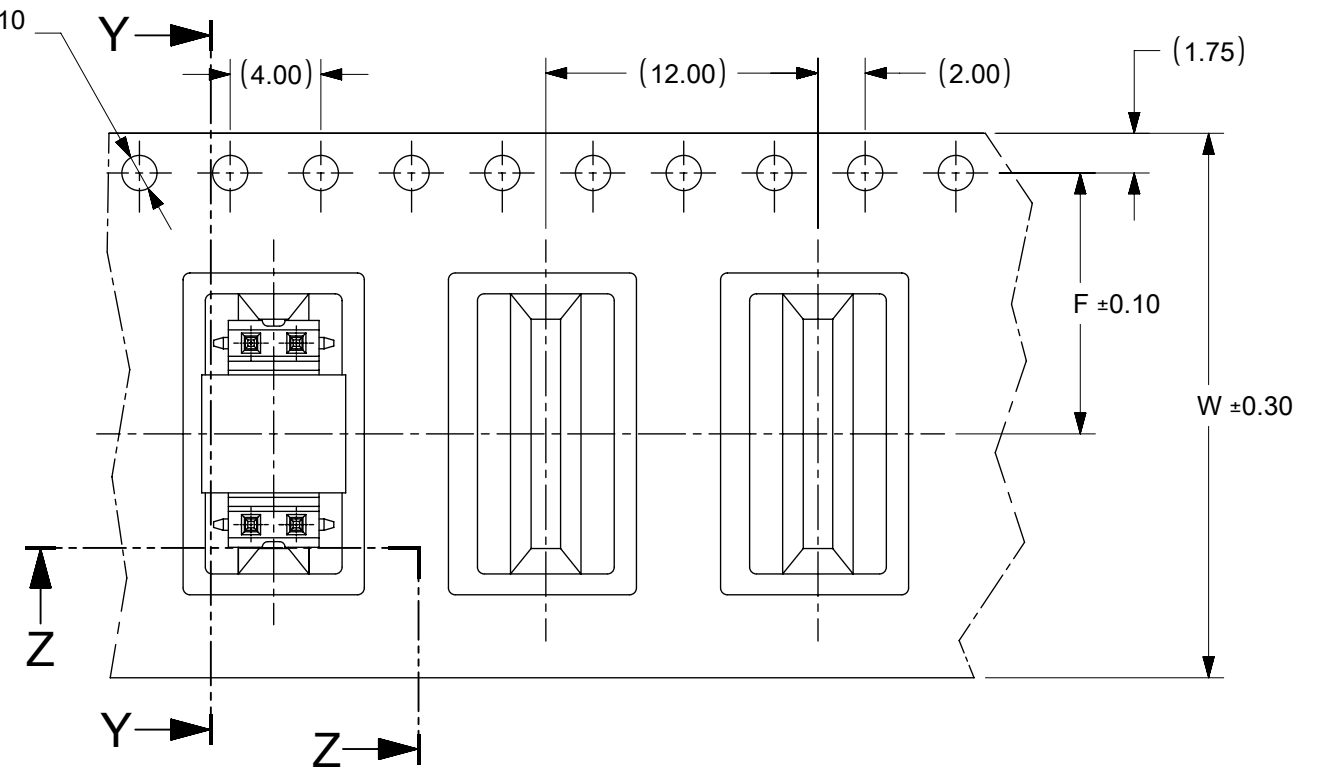

CUSTOMER
PULL OUT DIRECTION

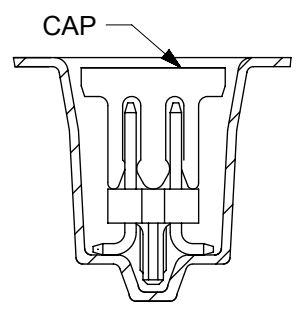

SECTION Z-Z

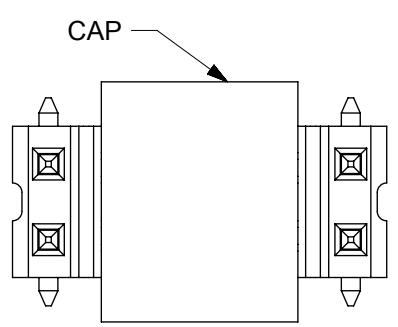

PART WITH CAP IN
TUBE ORIENTATION

THIS DRAWING CONTAINS INFORMATION THAT IS PROPRIETARY TO MOLEX ELECTRONIC TECHNOLOGIES, LLC AND SHOULD NOT BE USED WITHOUT WRITTEN PERMISSION									
DIMENSION UNITS		SCALE		CURRENT REV DESC:				molex	
mm		NTS							
GENERAL TOLERANCES (UNLESS SPECIFIED)				EC NO: 699037		CUSTOMER		CUSTOM HEADER	
				DRWN: DANUSA 2021/11/26		MGRID, 2MM DUAL ROW HDR WITH PEG, SMT			
4 PLACES ±		±		CHK'D: DANUSA 2022/03/10		PRODUCT CUSTOMER DRAWING			
3 PLACES ±		±		APPR: MRAMAKRISHNA 2022/03/10					
2 PLACES ± 0.2		±		INITIAL REVISION:		DOCUMENT NUMBER		DOC TYPE DOC PART REVISION	
1 PLACE ±		±		DRWN: KSEE 2003/12/22		SD-87759-208		PSD 001 D7	
0 PLACES ±		±		APPR: MLONG 2009/12/17		MATERIAL NUMBER		CUSTOMER	
ANGULAR TOL ± 3.0°				DRAFT WHERE APPLICABLE MUST REMAIN WITHIN DIMENSIONS		SEE TABLE		GENERAL MARKET	
		THIRD ANGLE PROJECTION		DRAWING		SERIES		SHEET NUMBER	
		A3-SIZE		87759		2 OF 4			

DOCUMENT STATUS	P1	RELEASE DATE	2022/03/10	13:29:35
-----------------	----	--------------	------------	----------

EMBOSED TYPE "B"

PART WITH CAP IN
TAPE & REEL ORIENTATION

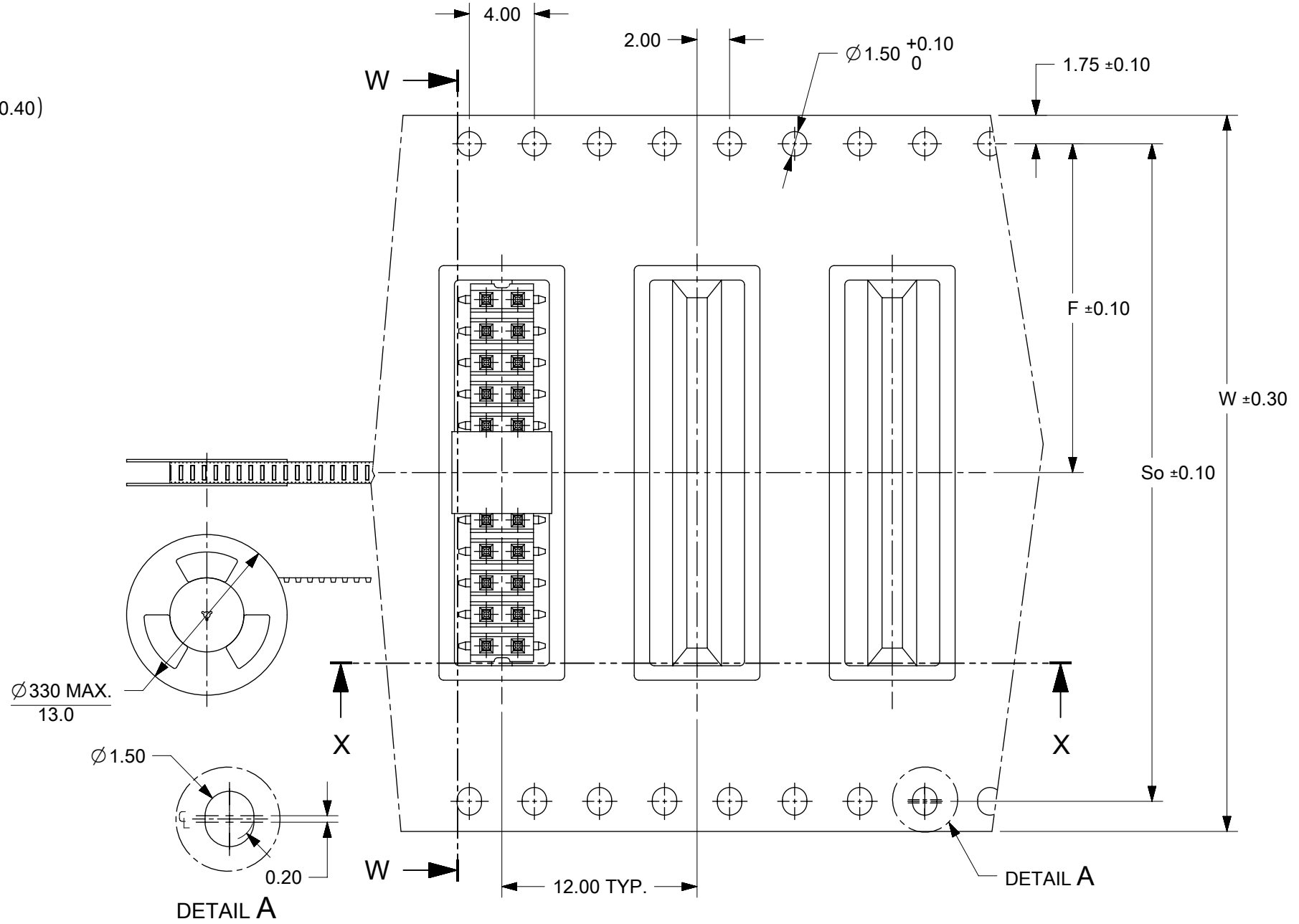
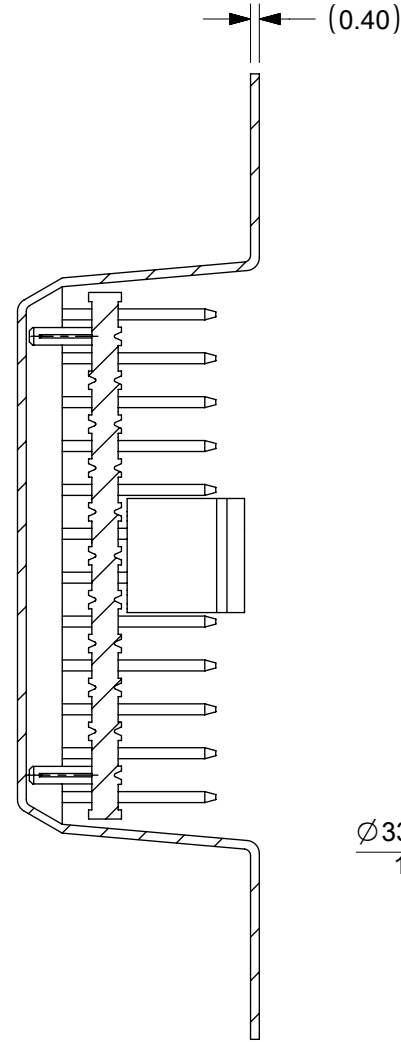

$\varnothing 330$ MAX.
13.0

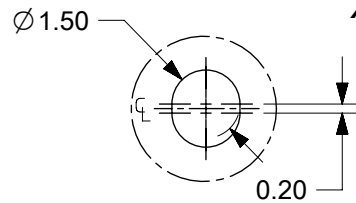

NOTES:

1. LEADER AND TRAILER TAPE

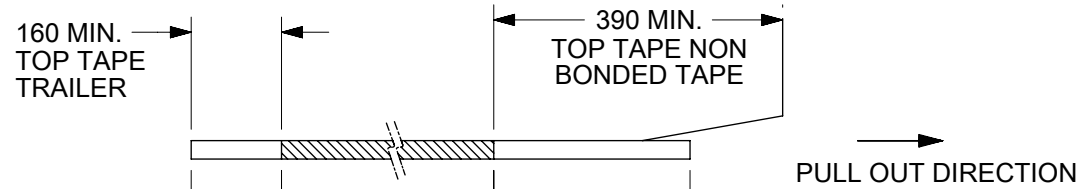

2. PEELING OFF FORCE OF THE TOP TAPE: 20 - 80gf.
(PEELING DIRECTION AS SHOWN IN FOLLOWING FIGURE)

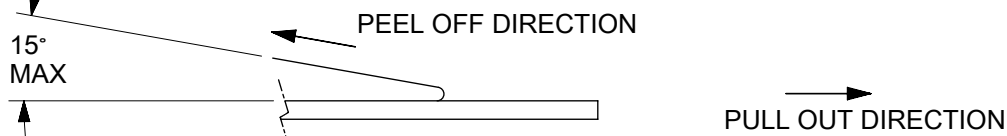

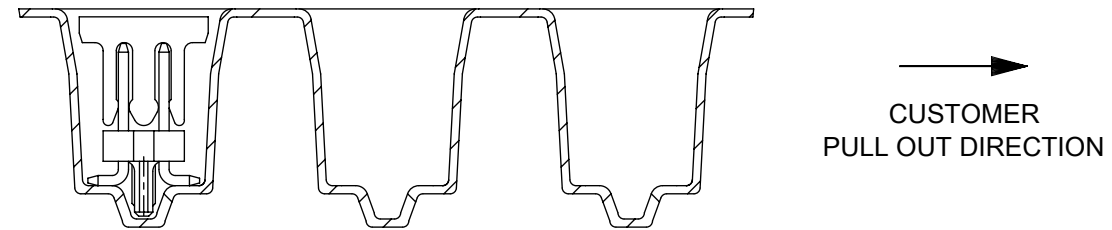

3. TAPE AND REEL SPECIFICATION IS AS PER EIA-481.
4. TAPE & REEL QUANTITY = 500 PCS/REEL
5. THE TAPE IS TREATED FOR ANTI-STATIC



THIS DRAWING CONTAINS INFORMATION THAT IS PROPRIETARY TO MOLEX ELECTRONIC TECHNOLOGIES, LLC AND SHOULD NOT BE USED WITHOUT WRITTEN PERMISSION											
DIMENSION UNITS		SCALE		CURRENT REV DESC:						molex	
mm		NTS									
GENERAL TOLERANCES (UNLESS SPECIFIED)				EC NO: 699037		DRWN: DANUSA		2021/11/26		CUSTOM HEADER	
4 PLACES		±		CHK'D: DANUSA		2022/03/10		MGRID, 2MM DUAL ROW HDR WITH PEG, SMT		A	
3 PLACES		±		APPR: MRAMAKRISHNA		2022/03/10		PRODUCT CUSTOMER DRAWING			
2 PLACES		± 0.2 ±		INITIAL REVISION:		DRWN: KSEE		2003/12/22		DOCUMENT NUMBER	
1 PLACE		±		APPR: MLONG		2009/12/17		SD-87759-208		DOC TYPE DOC PART REVISION	
0 PLACES		±		ANGULAR TOL ± 3.0°		DRAFT WHERE APPLICABLE MUST REMAIN WITHIN DIMENSIONS		THIRD ANGLE PROJECTION		DRAWING SERIES MATERIAL NUMBER CUSTOMER SHEET NUMBER	
P1		RELEASE DATE		2022/03/10		13:29:35		A3-SIZE		87759 SEE TABLE GENERAL MARKET 3 OF 4	

9		8		7		6		5		4		3		2		1	
PART NUMBER WITH CAP IN TUBE		PART NUMBER WITH CAP IN TAPE AND REEL.		PART NUMBER WITHOUT CAP IN TAPE AND REEL.		CKT SIZE	A	B	C	M	N	F	So	W	EMBOSSSED TYPE	CAP TYPE	PLATING OPTION
E	87759-0876	87759-7626				08	7.90	6.00	4.00	3.80	8.05	11.50	-	24.00	A	C1	1
	87759-5276	87759-7648				08	7.90	6.00	4.00	8.80	13.00	11.50	-	24.00	A	C2	
	87759-1076	87759-7627				10	9.90	8.00	6.00	3.80	8.05	11.50	-	24.00	A	C1	
	87759-1276	87759-7628		87759-7649 (D7)		12	11.90	10.00	8.00	3.80	8.05	11.50	-	24.00	A		
	87759-1476	87759-7629				14	13.90	12.00	10.00	3.80	8.05	11.50	-	24.00	A	C1	
	87759-1676	87759-7630				16	15.90	14.00	12.00	3.80	8.05	14.20	28.40	32.00	B	C1	
	87759-1876	87759-7631		87759-7650 (D7)		18	17.90	16.00	14.00	3.80	8.05	14.20	28.40	32.00	B	C1	
	87759-2076	87759-7632				20	19.90	18.00	16.00	3.80	8.05	20.20	40.40	44.00	B	C1	
	87759-2276	87759-7633				22	21.90	20.00	18.00	3.80	8.05	20.20	40.40	44.00	B	C1	
	87759-2476	87759-7634				24	23.90	22.00	20.00	3.80	8.05	20.20	40.40	44.00	B	C1	
	87759-2676	87759-7635				26	25.90	24.00	22.00	3.80	8.05	20.20	40.40	44.00	B	C1	
D	87759-2876	87759-7636				28	27.90	26.00	24.00	3.80	8.05	20.20	40.40	44.00	B	C1	
	87759-3076	87759-7637				30	29.90	28.00	26.00	3.80	8.05	20.20	40.40	44.00	B	C1	
	87759-3276	87759-7638				32	31.90	30.00	28.00	3.80	8.05	26.20	52.40	56.00	B	C1	
	87759-3476	87759-7639				34	33.90	32.00	30.00	3.80	8.05	26.20	52.40	56.00	B	C1	
	87759-3676	87759-7640				36	35.90	34.00	32.00	3.80	8.05	26.20	52.40	56.00	B	C1	
	87759-3876	87759-7641				38	37.90	36.00	34.00	3.80	8.05	26.20	52.40	56.00	B	C1	
	87759-4076	87759-7642				40	39.90	38.00	36.00	3.80	8.05	26.20	52.40	56.00	B	C1	
C	87759-4276	87759-7643				42	41.90	40.00	38.00	3.80	8.05	26.20	52.40	56.00	B	C1	
	87759-4476	87759-7644				44	43.90	42.00	40.00	3.80	8.05	26.20	52.40	56.00	B	C1	
	87759-4676	87759-7645				46	45.90	44.00	42.00	3.80	8.05	34.20	68.40	72.00	B	C1	
	87759-4876	87759-7646				48	47.90	46.00	44.00	3.80	8.05	34.20	68.40	72.00	B	C1	
	87759-5076	87759-7647				50	49.90	48.00	46.00	3.80	8.05	34.20	68.40	72.00	B	C1	

B																																																																																																																																											
A																																																																																																																																											
<table border="1"> <tr> <td colspan="16">THIS DRAWING CONTAINS INFORMATION THAT IS PROPRIETARY TO MOLEX ELECTRONIC TECHNOLOGIES, LLC AND SHOULD NOT BE USED WITHOUT WRITTEN PERMISSION</td> </tr> <tr> <td colspan="2">DIMENSION UNITS</td> <td colspan="2">SCALE</td> <td colspan="12">CURRENT REV DESC:</td> </tr> <tr> <td colspan="2">mm</td> <td colspan="2">NTS</td> <td colspan="12" rowspan="5"> <p style="text-align: center;">molex</p> <p style="text-align: center;">CUSTOM HEADER MGRID, 2MM DUAL ROW HDR WITH PEG, SMT</p> <p style="text-align: center;">PRODUCT CUSTOMER DRAWING</p> </td> </tr> <tr> <td colspan="4">GENERAL TOLERANCES (UNLESS SPECIFIED)</td> </tr> <tr> <td colspan="2"></td> <td>MM</td> <td>INCH</td> </tr> <tr> <td>4 PLACES</td> <td>±</td> <td></td> <td>±</td> </tr> <tr> <td>3 PLACES</td> <td>±</td> <td></td> <td>±</td> </tr> <tr> <td>2 PLACES</td> <td>±</td> <td>0.2</td> <td>±</td> </tr> <tr> <td>1 PLACE</td> <td>±</td> <td></td> <td>±</td> </tr> <tr> <td>0 PLACES</td> <td>±</td> <td></td> <td>±</td> </tr> <tr> <td colspan="4">ANGULAR TOL ± 3.0°</td> <td colspan="12"> <p>EC NO: 699037</p> <p>DRWN: DANUSA 2021/11/26</p> <p>CHK'D: DANUSA 2022/03/10</p> <p>APPR: MRAMAKRISHNA 2022/03/10</p> </td> </tr> <tr> <td colspan="4">DRAFT WHERE APPLICABLE MUST REMAIN WITHIN DIMENSIONS</td> <td colspan="2">THIRD ANGLE PROJECTION</td> <td colspan="2">DRAWING</td> <td colspan="2">SERIES</td> <td colspan="2">MATERIAL NUMBER</td> <td colspan="2">CUSTOMER</td> <td colspan="2">SHEET NUMBER</td> </tr> <tr> <td colspan="4"></td> <td colspan="2">  </td> <td colspan="2">A3-SIZE</td> <td colspan="2">87759</td> <td colspan="2">SEE TABLE</td> <td colspan="2">GENERAL MARKET</td> <td colspan="2">4 OF 4</td> </tr> </table>																THIS DRAWING CONTAINS INFORMATION THAT IS PROPRIETARY TO MOLEX ELECTRONIC TECHNOLOGIES, LLC AND SHOULD NOT BE USED WITHOUT WRITTEN PERMISSION																DIMENSION UNITS		SCALE		CURRENT REV DESC:												mm		NTS		<p style="text-align: center;">molex</p> <p style="text-align: center;">CUSTOM HEADER MGRID, 2MM DUAL ROW HDR WITH PEG, SMT</p> <p style="text-align: center;">PRODUCT CUSTOMER DRAWING</p>												GENERAL TOLERANCES (UNLESS SPECIFIED)						MM	INCH	4 PLACES	±		±	3 PLACES	±		±	2 PLACES	±	0.2	±	1 PLACE	±		±	0 PLACES	±		±	ANGULAR TOL ± 3.0°				<p>EC NO: 699037</p> <p>DRWN: DANUSA 2021/11/26</p> <p>CHK'D: DANUSA 2022/03/10</p> <p>APPR: MRAMAKRISHNA 2022/03/10</p>												DRAFT WHERE APPLICABLE MUST REMAIN WITHIN DIMENSIONS				THIRD ANGLE PROJECTION		DRAWING		SERIES		MATERIAL NUMBER		CUSTOMER		SHEET NUMBER								A3-SIZE		87759		SEE TABLE		GENERAL MARKET		4 OF 4	
THIS DRAWING CONTAINS INFORMATION THAT IS PROPRIETARY TO MOLEX ELECTRONIC TECHNOLOGIES, LLC AND SHOULD NOT BE USED WITHOUT WRITTEN PERMISSION																																																																																																																																											
DIMENSION UNITS		SCALE		CURRENT REV DESC:																																																																																																																																							
mm		NTS		<p style="text-align: center;">molex</p> <p style="text-align: center;">CUSTOM HEADER MGRID, 2MM DUAL ROW HDR WITH PEG, SMT</p> <p style="text-align: center;">PRODUCT CUSTOMER DRAWING</p>																																																																																																																																							
GENERAL TOLERANCES (UNLESS SPECIFIED)																																																																																																																																											
		MM	INCH																																																																																																																																								
4 PLACES	±		±																																																																																																																																								
3 PLACES	±		±																																																																																																																																								
2 PLACES	±	0.2	±																																																																																																																																								
1 PLACE	±		±																																																																																																																																								
0 PLACES	±		±																																																																																																																																								
ANGULAR TOL ± 3.0°				<p>EC NO: 699037</p> <p>DRWN: DANUSA 2021/11/26</p> <p>CHK'D: DANUSA 2022/03/10</p> <p>APPR: MRAMAKRISHNA 2022/03/10</p>																																																																																																																																							
DRAFT WHERE APPLICABLE MUST REMAIN WITHIN DIMENSIONS				THIRD ANGLE PROJECTION		DRAWING		SERIES		MATERIAL NUMBER		CUSTOMER		SHEET NUMBER																																																																																																																													
						A3-SIZE		87759		SEE TABLE		GENERAL MARKET		4 OF 4																																																																																																																													
<table border="1"> <tr> <td>DOCUMENT STATUS</td> <td>P1</td> <td>RELEASE DATE</td> <td>2022/03/10</td> <td>13:29:35</td> <td colspan="11"></td> </tr> </table>																DOCUMENT STATUS	P1	RELEASE DATE	2022/03/10	13:29:35																																																																																																																							
DOCUMENT STATUS	P1	RELEASE DATE	2022/03/10	13:29:35																																																																																																																																							