

- NOTES**
- MATERIAL:**
HSG: NYLON, GLASS-FILLED, UL94V-0 COLOR: BLACK
PIN: 0.64MM SQ, COPPER ALLOY
 - PLATING TYPE:**
 - GOLD FLASH OVER
1.25µm MIN. NICKEL OVERALL.
 - GOLD FLASH ON CONTACT AND
2.50µm MIN. TIN ON SOLDER TAIL OVER
1.25µm MIN. NICKEL OVERALL.
 - 0.38µm MIN. GOLD PLATE ON CONTACT AND
2.00µm MIN. TIN ON SOLDER TAIL OVER
1.25µm MIN. NICKEL OVERALL.
 - 0.75µm MIN. GOLD PLATE ON CONTACT AND
2.00µm MIN. TIN ON SOLDER TAIL OVER
1.25µm MIN. NICKEL OVERALL.
 - 2.50µm MIN TIN OVERALL
1.25µm MIN NICKEL OVERALL
 - PRODUCT SPECIFICATION:** PS-87920-019
 - PACKAGING TYPE:** SEE TABLE
 - WAFER TO BE FLAT WITHIN 0.003 mm/mm**
 - RECOMMENDED PCB THICKNESS IS 1.60mm ± 0.10**
 ∇ IRREGULAR CIRCUIT CUTOFF WITHIN BREAKAWAY SECTION IS PERMISSIBLE. CUTTING OR CHIPPING OF THE MAIN BODY IS NOT ACCEPTABLE
 - THE ABOVE CKT 6 IS FOR ILLUSTRATION PURPOSE ONLY**
 - PACKAGING SPECIFICATION:**
 TRAY: PK-89990-489
 BULK: PK-89990-491
 T&R : PK-87898-400
 TUBE: PK-89990-934
 - REFER SHEET 2 FOR CAP LOCATION.**

| | | | | | | |
|--|---|--|--------------------------------|--------------|-----------------|--------------------------|
| FUNCTIONAL SYMBOLS FA = 0 FE = 0 FP = 0 | THIS DRAWING CONTAINS INFORMATION THAT IS PROPRIETARY TO MOLEX ELECTRONIC TECHNOLOGIES, LLC AND SHOULD NOT BE USED WITHOUT WRITTEN PERMISSION | | CURRENT REV DESC: | | molex | |
| | DIMENSION UNITS | SCALE | EC NO: 671127 | | | CUSTOMER DRAWING |
| | mm | NTS | DRWN: ABABUPS 2021/07/19 | | | |
| | GENERAL TOLERANCES (UNLESS SPECIFIED) | | CHK'D: MRAMAKRISHNA 2021/07/23 | | | PRODUCT CUSTOMER DRAWING |
| 4 PLACES ± | | APPR: MRAMAKRISHNA 2021/07/23 | | | | |
| DIVISIONAL SYMBOLS | MM | | INITIAL REVISION: | | DOCUMENT NUMBER | |
| | 3 PLACES ± | | DRWN: KCHO 2004/03/24 | | SD-87891-001 | |
| | 2 PLACES ± 0.2 | | APPR: SLOW 2004/04/08 | | DOC TYPE | |
| | 1 PLACE ± | | ANGULAR TOL ± 3.0° | | PSD | |
| 0 PLACES ± | | DRAFT WHERE APPLICABLE MUST REMAIN WITHIN DIMENSIONS | | DOC PART | | |
| THIRD ANGLE PROJECTION | | DRAWING | | REVISION | | |
| A3-SIZE | | SERIES | | D18 | | |
| MATERIAL NUMBER | | CUSTOMER | | SHEET NUMBER | | |
| SEE TABLE | | GENERAL MARKET | | 1 OF 4 | | |

CAP INFORMATION- CAP OPTION A

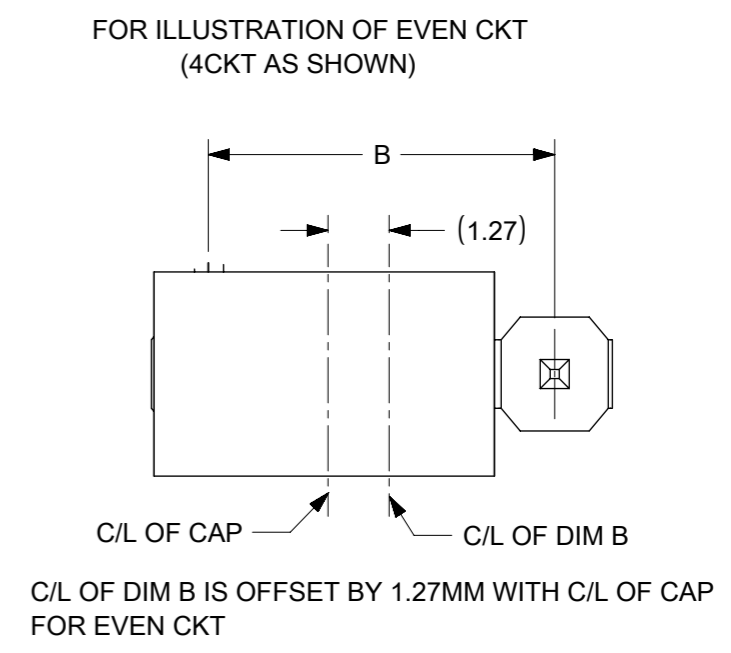
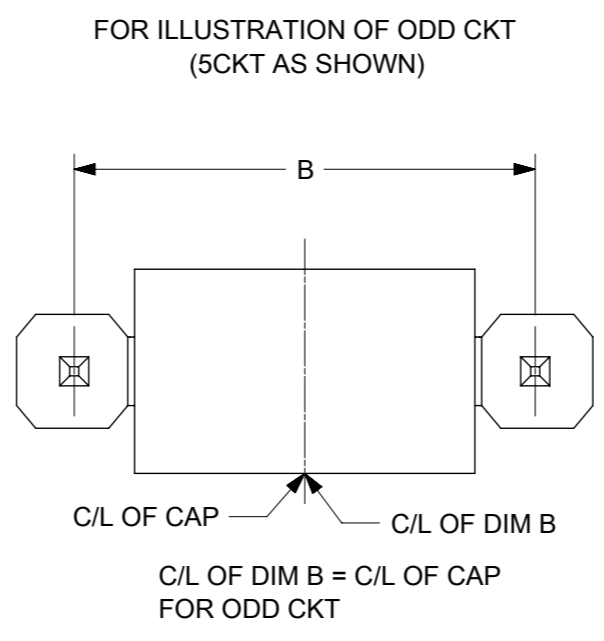
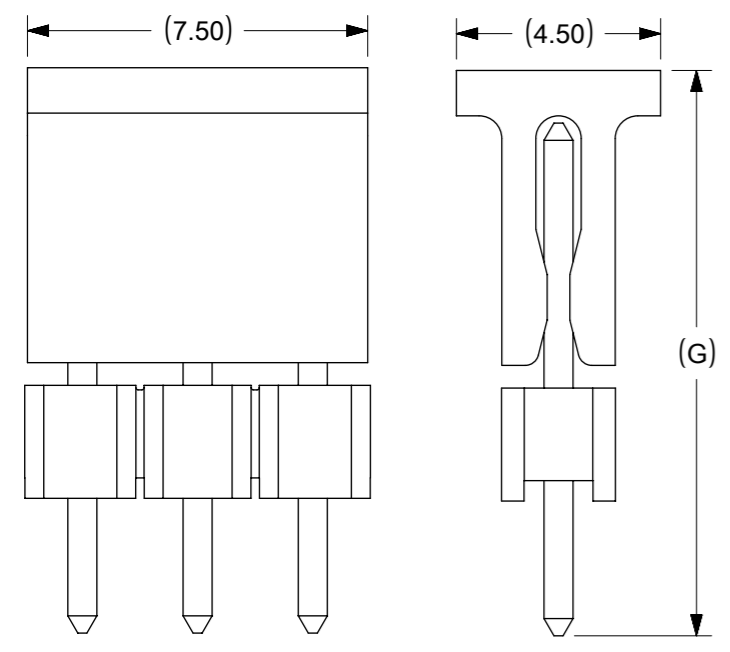

CAP INFORMATION- CAP OPTION B

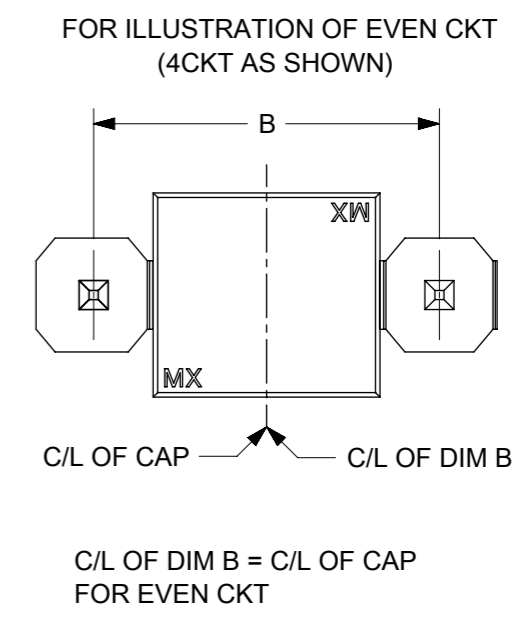
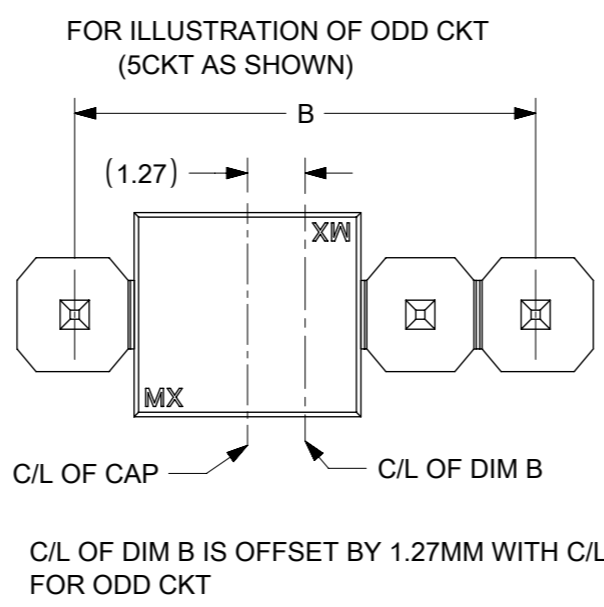
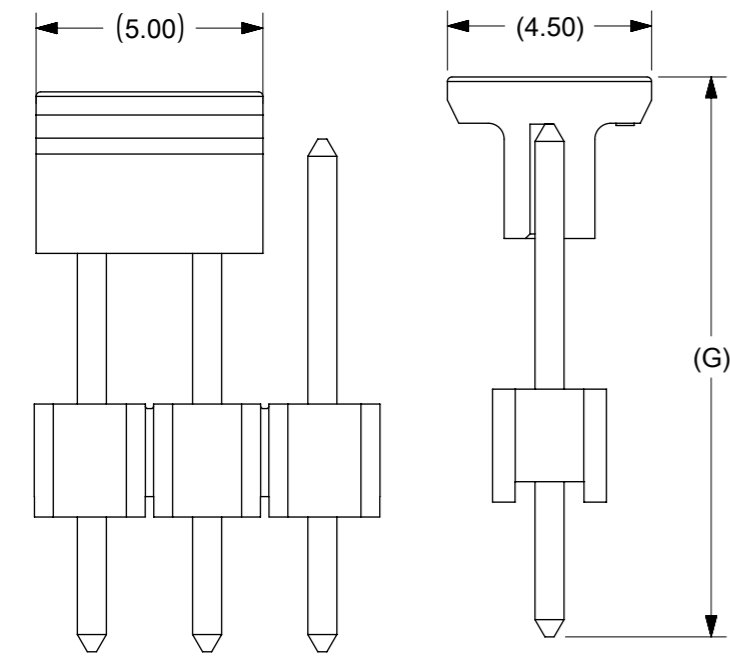

| FUNCTIONAL SYMBOLS | THIS DRAWING CONTAINS INFORMATION THAT IS PROPRIETARY TO MOLEX ELECTRONIC TECHNOLOGIES, LLC AND SHOULD NOT BE USED WITHOUT WRITTEN PERMISSION | | CURRENT REV DESC: | | | | | | | | | | | | | | | | | | | | | | |
|--|--|---|-------------------------------|--|--|----------------------------|------------------------|---------------------|----------|---|---|----------|-------|---|---------|---|---|----------|---|---|---|--|--------------------------|--|--|
| | $\frac{F}{A} = 0$ $\frac{F}{E} = 0$ $\frac{F}{P} = 0$ | DIMENSION UNITS mm | | | | | | SCALE NTS | | | | | | | | | | | | | | | | | |
| DIVISIONAL SYMBOLS | GENERAL TOLERANCES (UNLESS SPECIFIED) | | EC NO: 671127 | | CUSTOM HEADER 2.54MM PITCH, SINGLE ROW SINGLE WAFER, T/H HEADER | | | | | | | | | | | | | | | | | | | | |
| | | | DRWN: ABABUPS 2021/07/19 | | | | | | | | | | | | | | | | | | | | | | |
| | <table border="1"> <thead> <tr> <th></th> <th>MM</th> <th>INCH</th> </tr> </thead> <tbody> <tr> <td>4 PLACES</td> <td>±</td> <td>±</td> </tr> <tr> <td>3 PLACES</td> <td>±</td> <td>±</td> </tr> <tr> <td>2 PLACES</td> <td>± 0.2</td> <td>±</td> </tr> <tr> <td>1 PLACE</td> <td>±</td> <td>±</td> </tr> <tr> <td>0 PLACES</td> <td>±</td> <td>±</td> </tr> </tbody> </table> | | | MM | INCH | 4 PLACES | ± | ± | 3 PLACES | ± | ± | 2 PLACES | ± 0.2 | ± | 1 PLACE | ± | ± | 0 PLACES | ± | ± | CHK'D: MRAMAKRISHNA 2021/07/23 APPR: MRAMAKRISHNA 2021/07/23 | | PRODUCT CUSTOMER DRAWING | | |
| | | MM | INCH | | | | | | | | | | | | | | | | | | | | | | |
| | 4 PLACES | ± | ± | | | | | | | | | | | | | | | | | | | | | | |
| 3 PLACES | ± | ± | | | | | | | | | | | | | | | | | | | | | | | |
| 2 PLACES | ± 0.2 | ± | | | | | | | | | | | | | | | | | | | | | | | |
| 1 PLACE | ± | ± | | | | | | | | | | | | | | | | | | | | | | | |
| 0 PLACES | ± | ± | | | | | | | | | | | | | | | | | | | | | | | |
| ANGULAR TOL ± 3.0° | | INITIAL REVISION: DRWN: KCHO 2004/03/24 APPR: SLOW 2004/04/08 | | DOCUMENT NUMBER SD-87891-001 | | DOC TYPE PSD | DOC PART 000 | REVISION D18 | | | | | | | | | | | | | | | | | |
| DRAFT WHERE APPLICABLE MUST REMAIN WITHIN DIMENSIONS | | THIRD ANGLE PROJECTION | DRAWING A3-SIZE | SERIES 87891 | MATERIAL NUMBER SEE TABLE | CUSTOMER GENERAL MARKET | SHEET NUMBER 2 OF 4 | | | | | | | | | | | | | | | | | | |

| CKT SIZE | DIMENSION | | ASSY W/CAP IN T&R | ASSY W/O CAP IN T&R | ASSY W/O CAP IN TUBE | ASSY W/CAP IN TUBE | PART NO. W/O CAP IN TRAY PACKAGING | PART NO. IN BULK PACKAGING | CKT SIZE | VOID PIN | KINK PIN | (G) | DIMENSION | | | PLATING TYPE | CAP OPTION | REMARKS |
|----------|-----------|-------|-------------------|---------------------|----------------------|--------------------|------------------------------------|----------------------------|----------|----------|----------|-------|-----------|------------|--------------|--------------|------------|---------------------------------------|
| | A | B | | | | | | | | | | | OAL | MATING END | SOLDIER TAIL | | | |
| | | | | | | | | | | | | | | | | | | |
| 01 | 2.54 | --- | - | - | - | - | 87891-0108 | - | 01 | - | - | - | 10.80 | 5.08 | 3.23 | 5 | - | - |
| 02 | 5.08 | 2.54 | - | - | - | - | 87891-1017 | - | 01 | - | - | - | 12.29 | 6.80 | 3.00 | 3 | - | - |
| 03 | 7.62 | 5.08 | - | - | - | - | 87891-0200 | - | 02 | - | - | - | 11.76 | 6.09 | 3.18 | 5 | - | - |
| 04 | 10.16 | 7.62 | - | - | - | - | 87891-0205 | - | 02 | - | - | - | 11.30 | 5.84 | 2.97 | 4 | - | - |
| 05 | 12.70 | 10.16 | - | - | - | - | 87891-0206 | - | 02 | - | - | - | 11.30 | 5.84 | 2.97 | 5 | - | - |
| 06 | 15.24 | 12.70 | - | - | - | - | 87891-0211 | - | 02 | - | - | - | 11.30 | 5.84 | 2.97 | 5 | - | - |
| 07 | 17.78 | 15.24 | - | - | - | - | 87891-0207 | - | 02 | - | - | - | 9.80 | 4.00 | 3.31 | 5 | - | - |
| 08 | 20.32 | 17.78 | - | - | - | - | 87891-0208 | - | 02 | - | - | - | 7.49 | 4.00 | 1.00 | 2 | - | - |
| 09 | 22.86 | 20.32 | - | - | - | - | 87891-0209 | - | 02 | - | - | - | 10.80 | 5.08 | 3.23 | 5 | - | - |
| 10 | 25.40 | 22.86 | - | - | - | - | 87891-0210 | - | 02 | - | - | - | 31.00 | 25.54 | 2.97 | 5 | - | - |
| 11 | 27.94 | 25.40 | - | - | - | - | 87891-0216 | - | 02 | - | - | - | 7.29 | 2.40 | 2.40 | 5 | - | - |
| 12 | 30.48 | 27.94 | - | - | - | - | 87891-0212 | - | 02 | - | - | - | 18.37 | 12.68 | 3.20 | 5 | - | - |
| 13 | 33.02 | 30.48 | - | - | - | - | 87891-0211 | - | 02 | - | - | - | 26.49 | 20.80 | 3.20 | 5 | - | - |
| 14 | 35.56 | 33.02 | - | - | - | - | 87891-0214 | - | 02 | - | - | - | 19.49 | 13.00 | 4.00 | 5 | - | - |
| 15 | 38.10 | 35.56 | - | - | - | - | 87891-0215 | - | 02 | - | - | 14.98 | 13.98 | 7.49 | 4.00 | 5 | A | - |
| 16 | 40.64 | 38.10 | - | - | - | - | 87891-0213 | - | 02 | - | - | - | 12.14 | 5.84 | 3.81 | 4 | - | - |
| 17 | 43.18 | 40.64 | - | - | - | - | 87891-0306 | - | 03 | - | - | - | 11.30 | 5.84 | 2.97 | 5 | - | - |
| 18 | 45.72 | 43.18 | - | - | - | - | 87891-0308 | - | 03 | - | - | - | 11.30 | 5.84 | 2.97 | 5 | - | - |
| 19 | 48.26 | 45.72 | - | - | - | - | 87891-0307 | - | 03 | - | - | - | 22.73 | 18.74 | 1.50 | 5 | - | - |
| 20 | 50.80 | 48.26 | - | - | - | - | 87891-0303 | - | 03 | 2 | - | - | 13.72 | 9.65 | 1.78 | 6 | - | - |
| 21 | 53.34 | 50.80 | - | - | - | - | 87891-0003 | - | 03 | - | - | - | 11.30 | 5.84 | 2.97 | 4 | - | - |
| 22 | 55.88 | 53.34 | - | - | - | - | 87891-0312 | - | 03 | - | - | - | 11.30 | 5.84 | 2.97 | 4 | - | - |
| 23 | 58.42 | 55.88 | - | - | - | - | 87891-0311 | - | 03 | - | - | 12.34 | 11.30 | 5.84 | 2.97 | 5 | B | REFER RPK-87891-0311 (FOR 87891-0311) |
| 24 | 60.96 | 58.42 | - | - | - | - | 87891-0313 | - | 03 | - | - | 12.34 | 11.30 | 5.84 | 2.97 | 5 | B | - |
| 25 | 63.50 | 60.96 | - | - | - | - | - | 87891-0310 | 03 | - | - | - | 6.49 | 2.00 | 2.00 | 5 | - | - |
| 26 | 66.04 | 63.50 | - | - | - | - | 87891-0402 | - | 04 | 2 | - | - | 10.80 | 5.89 | 2.41 | 5 | - | - |
| 27 | 68.58 | 66.04 | - | - | - | - | 87891-0004 | - | 04 | - | - | - | 35.10 | 29.71 | 3.10 | 6 | - | - |
| 28 | 71.12 | 68.58 | - | - | - | - | 87891-0411 | - | 04 | - | - | - | 10.09 | 4.00 | 3.60 | 5 | - | - |
| 29 | 73.66 | 71.12 | - | - | - | - | 87891-0407 | - | 04 | - | - | - | 9.80 | 4.00 | 3.31 | 5 | - | - |
| 30 | 76.20 | 73.66 | - | - | - | - | 87891-0408 | - | 04 | - | - | - | 31.00 | 25.54 | 2.97 | 5 | - | - |
| 31 | 78.74 | 76.20 | - | - | - | - | 87891-0418 | - | 04 | - | - | - | 12.14 | 6.75 | 2.90 | 5 | - | REFER 878910418-RPK (FOR 87891-0418) |
| 32 | 81.28 | 78.74 | - | - | - | - | 87891-0409 | - | 04 | - | - | - | 12.14 | 6.75 | 2.90 | 4 | - | - |
| 33 | 83.82 | 81.28 | - | - | - | - | 87891-0417 | - | 04 | - | - | 16.31 | 15.11 | 9.01 | 3.61 | 5 | A | - |
| 34 | 86.36 | 83.82 | - | - | - | - | 87891-0432 | - | 04 | - | - | - | 18.03 | 13.54 | 2.00 | 5 | - | - |
| 35 | 88.90 | 86.36 | - | - | - | - | 87891-0430 | - | 04 | - | - | - | 13.09 | 8.00 | 2.80 | 5 | A | - |
| 36 | 91.44 | 88.90 | - | - | - | - | 87891-0500 | - | 05 | - | - | - | 11.94 | 6.10 | 3.30 | 5 | - | - |
| 37 | 93.98 | 91.44 | - | - | - | - | 87891-0505 | - | 05 | - | - | - | 11.94 | 6.10 | 3.30 | 5 | - | - |
| 38 | 96.52 | 93.98 | - | - | - | - | - | - | - | - | - | - | - | - | - | - | - | - |
| 39 | 99.06 | 96.52 | - | - | - | - | - | - | - | - | - | - | - | - | - | - | - | - |
| 40 | 101.60 | 99.06 | - | - | - | - | - | - | - | - | - | - | - | - | - | - | - | - |

| | | | |
|--|---------------------------------------|---|--------------------------------|
| FUNCTIONAL SYMBOLS | | THIS DRAWING CONTAINS INFORMATION THAT IS PROPRIETARY TO MOLEX ELECTRONIC TECHNOLOGIES, LLC AND SHOULD NOT BE USED WITHOUT WRITTEN PERMISSION | |
| $\nabla_A = 0$ | mm | SCALE | NTS |
| $\nabla_F = 0$ | GENERAL TOLERANCES (UNLESS SPECIFIED) | | |
| $\nabla_P = 0$ | MM INCH | | |
| DIVISIONAL SYMBOLS | | CURRENT REV DESC: | |
| 4 PLACES | ± | ± | EC NO: 671127 |
| 3 PLACES | ± | ± | DRWN: ABABUPS 2021/07/19 |
| 2 PLACES | ± | 0.2 | CHK'D: MRAMAKRISHNA 2021/07/23 |
| 1 PLACE | ± | ± | APPR: MRAMAKRISHNA 2021/07/23 |
| 0 PLACES | ± | ± | INITIAL REVISION: |
| ANGULAR TOL ± 3.0° | | DRWN: KCHO 2004/03/24 | |
| DRAFT WHERE APPLICABLE MUST REMAIN WITHIN DIMENSIONS | | APPR: SLOW 2004/04/08 | |
| THIRD ANGLE PROJECTION | | DRAWING | |
| SERIES | | MATERIAL NUMBER | |
| CUSTOMER | | SHEET NUMBER | |
| A3-SIZE | | 87891 | |
| SEE TABLE | | GENERAL MARKET | |
| 3 OF 4 | | 3 OF 4 | |

| | | | | |
|-----------------|----|--------------|------------|----------|
| DOCUMENT STATUS | P1 | RELEASE DATE | 2021/07/23 | 06:50:15 |
|-----------------|----|--------------|------------|----------|

| F | ASSY W/CAP IN T&R | ASSY W/O CAP IN T&R | ASSY W/O CAP IN TUBE | ASSY W/CAP IN TUBE | PART NO. W/O CAP IN TRAY PACKAGING | PART NO. IN BULK PACKAGING | CKT SIZE | VOID PIN | KINK PIN | (G) | | | PLATING TYPE | CAP OPTION | REMARKS | |
|------------|-------------------|---------------------|----------------------|--------------------|------------------------------------|----------------------------|----------|----------|----------|-------|-------|------------|--------------|------------|---------|---|
| | | | | | | | | | | | OAL | MATING END | | | | |
| | | | | | | | | | | | (F) | M | | | | |
| - | - | - | - | - | 87891-0501 | - | 05 | - | - | - | 13.62 | 8.08 | 3.05 | 5 | - | - |
| - | - | - | - | - | 87891-0502 | - | 05 | 2 | - | - | 10.80 | 5.89 | 2.41 | 5 | - | - |
| - | - | - | - | - | 87891-0503 | - | 05 | 2 | - | - | 45.00 | 13.51 | 29.00 | 5 | - | - |
| - | - | - | - | - | 87891-0504 | - | 05 | 2 | - | - | 45.00 | 13.51 | 29.00 | 3 | - | - |
| - | - | - | - | - | 87891-0507 | - | 05 | 4 | - | - | 10.92 | 5.84 | 2.59 | 3 | - | - |
| - | - | - | - | - | - | 87891-0508 | 05 | 2,4 | - | - | 11.38 | 5.84 | 3.05 | 5 | - | - |
| - | - | - | - | - | 87891-0522 | - | 05 | 2&4 | - | - | 19.49 | 13.00 | 4.00 | 5 | - | - |
| - | - | - | - | - | 87891-0516 | - | 05 | - | - | - | 32.49 | 16.00 | 14.00 | 4 | - | - |
| - | - | - | - | - | 87891-0517 | - | 05 | - | - | - | 23.62 | 17.32 | 3.81 | 5 | - | - |
| - | - | - | - | - | 87891-0523 | - | 05 | - | - | - | 7.29 | 2.40 | 2.40 | 5 | - | - |
| - | 87891-0521 | - | - | - | - | - | 05 | - | - | 10.10 | 9.89 | 2.80 | 4.60 | 5 | A | - |
| - | - | - | - | - | 87891-0601 | - | 06 | - | - | - | 11.30 | 5.84 | 2.97 | 1 | - | - |
| - | - | - | - | - | 87891-0602 | - | 06 | - | - | - | 12.80 | 8.00 | 2.31 | 5 | - | - |
| - | - | - | - | - | 87891-0606 | - | 06 | - | - | - | 11.30 | 5.84 | 2.97 | 5 | - | - |
| - | - | - | - | - | 87891-0610 | - | 06 | - | - | - | 11.30 | 5.84 | 2.97 | 5 | - | - |
| - | - | - | - | - | 87891-0607 | - | 06 | - | - | - | 13.75 | 8.08 | 3.18 | 5 | - | - |
| - | - | - | - | - | 87891-0608 | - | 06 | - | - | - | 18.03 | 13.54 | 2.00 | 5 | - | - |
| - | - | - | - | - | 87891-0609 | - | 06 | - | - | - | 28.30 | 22.16 | 3.65 | 5 | - | - |
| - | - | - | - | - | 87891-0611 | - | 06 | - | - | - | 28.30 | 22.16 | 3.65 | 5 | - | - |
| 87891-0613 | - | - | - | - | - | - | 06 | - | - | 22.99 | 21.99 | 16.00 | 3.50 | 5 | A | - |
| - | - | - | - | - | 87891-0615 | - | 06 | - | - | - | 14.49 | 10.00 | 2.00 | 1 | - | - |
| - | - | - | - | - | 87891-0624 | - | 06 | - | - | - | 26.10 | 19.81 | 3.80 | 5 | - | - |
| - | - | - | - | - | 87891-0700 | - | 07 | - | - | - | 11.94 | 6.10 | 3.30 | 5 | - | - |
| - | - | - | - | - | 87891-0702 | - | 07 | - | - | - | 11.94 | 6.10 | 3.30 | 5 | - | - |
| - | - | - | - | - | 87891-0751 | - | 07 | - | - | - | 13.74 | 8.00 | 3.25 | 5 | - | - |
| 87891-0007 | - | - | - | - | - | - | 07 | - | - | - | 13.72 | 9.65 | 1.78 | 6 | - | - |
| - | - | - | - | - | 87891-0851 | - | 08 | - | - | - | 13.74 | 8.00 | 3.25 | 5 | - | - |
| 87891-0807 | - | - | - | - | - | - | 08 | - | - | 13.59 | 12.59 | 7.90 | 2.20 | 5 | A | - |
| - | - | - | - | - | 87891-0808 | - | 08 | - | - | - | 20.53 | 13.72 | 4.32 | 3 | - | - |
| - | - | - | - | - | 87891-0809 | - | 08 | - | - | - | 11.30 | 5.84 | 2.97 | 5 | - | - |
| - | - | - | - | - | - | 87891-2601 | 26 | 4,7,17 | - | - | 11.13 | 5.59 | 3.05 | 3 | - | - |
| 87891-1817 | - | - | - | - | - | - | 18 | - | - | 18.36 | 17.20 | 13.21 | 1.50 | 5 | A | - |
| 87891-1819 | - | - | - | - | - | - | 18 | - | - | 18.36 | 17.20 | 13.21 | 1.50 | 5 | A | - |
| 87891-1818 | - | - | - | - | - | - | 18 | - | - | 18.36 | 17.20 | 13.21 | 1.50 | 3 | A | - |
| - | - | - | - | - | 87891-2007 | - | 20 | - | - | - | 21.49 | 9.50 | 9.50 | 1 | - | - |
| 87891-2817 | - | - | - | - | - | - | 28 | - | - | 18.36 | 17.20 | 13.21 | 1.50 | 5 | A | - |
| 87891-2819 | - | - | - | - | - | - | 28 | - | - | 18.36 | 17.20 | 13.21 | 1.50 | 5 | A | - |
| 87891-2818 | - | - | - | - | - | - | 28 | - | - | 18.36 | 17.20 | 13.21 | 1.50 | 3 | A | - |
| - | - | - | - | - | - | 87891-3007 | 30 | - | - | - | 11.30 | 5.84 | 2.97 | 5 | - | - |
| - | - | - | - | - | - | 87891-3600 | 36 | - | - | - | 11.56 | 6.09 | 3.18 | 2 | - | - |
| - | - | - | - | - | - | 87891-4008 | 40 | - | - | - | 11.30 | 5.84 | 2.97 | 5 | - | - |
| - | - | 87891-4007 | - | - | - | - | 40 | - | - | - | 12.14 | 5.84 | 3.81 | 3 | - | - |

D17

D17

D17

D17

D17

D17

| | | | | | | | | | | | | | | | | | | | | | | | | | | | | | |
|--|--|--|--|--|---|--|--|--|--|---|--|--|--|--|---|--|--|--|--|---|--|--|--|--|---|--|--|--|--|
| FUNCTIONAL SYMBOLS | | | | | | | | | | THIS DRAWING CONTAINS INFORMATION THAT IS PROPRIETARY TO MOLEX ELECTRONIC TECHNOLOGIES, LLC AND SHOULD NOT BE USED WITHOUT WRITTEN PERMISSION | | | | | | | | | | | | | | | | | | | |
| $\nabla_A = 0$ $\nabla_F = 0$ $\nabla_P = 0$ | | | | | DIMENSION UNITS: mm SCALE: NTS | | | | | CURRENT REV DESC: | | | | |  CUSTOM HEADER 2.54MM PITCH, SINGLE ROW SINGLE WAFER, T/H HEADER | | | | | | | | | | | | | | |
| DIVISIONAL SYMBOLS | | | | | GENERAL TOLERANCES (UNLESS SPECIFIED) 4 PLACES: ± 3 PLACES: ± 2 PLACES: ± 0.2 1 PLACE: ± 0 PLACES: ± | | | | | EC NO: 671127 DRWN: ABABUPS 2021/07/19 CHK'D: MRAMAKRISHNA 2021/07/23 APPR: MRAMAKRISHNA 2021/07/23 | | | | | | | | | | | | | | | | | | | |
| DRAFT WHERE APPLICABLE MUST REMAIN WITHIN DIMENSIONS | | | | | | | | | | THIRD ANGLE PROJECTION | | | | | DRAWING: A3-SIZE SERIES: 87891 MATERIAL NUMBER: SEE TABLE CUSTOMER: GENERAL MARKET | | | | | INITIAL REVISION: DRWN: KCHO 2004/03/24 APPR: SLOW 2004/04/08 | | | | | PRODUCT CUSTOMER DRAWING DOCUMENT NUMBER: SD-87891-001 DOC TYPE: PSD DOC PART: 000 REVISION: D18 SHEET NUMBER: 4 OF 4 | | | | |
| DOCUMENT STATUS: P1 RELEASE DATE: 2021/07/23 06:50:15 | | | | | | | | | | | | | | | | | | | | | | | | | | | | | |

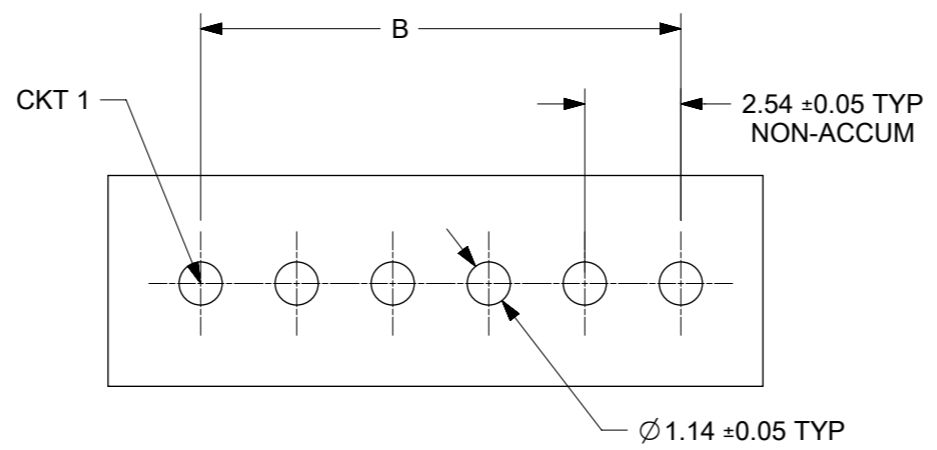
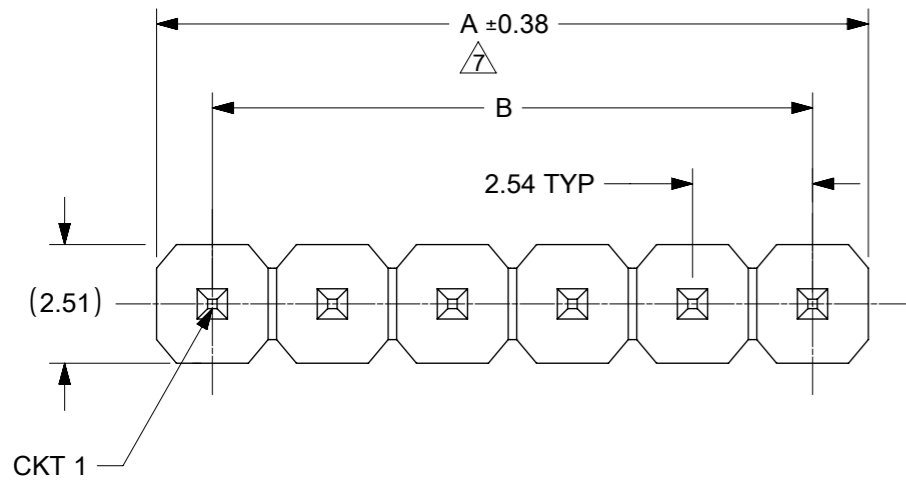

RECOMENDED P.C.B HOLE LAYOUT

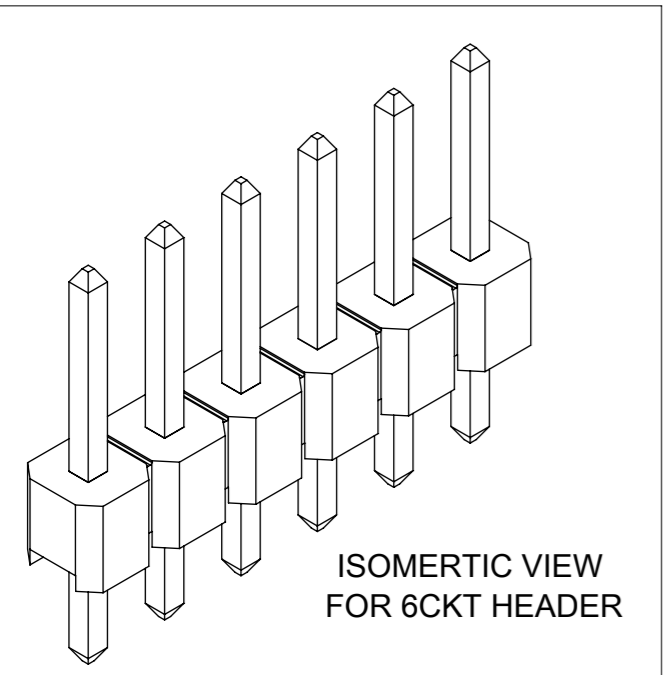
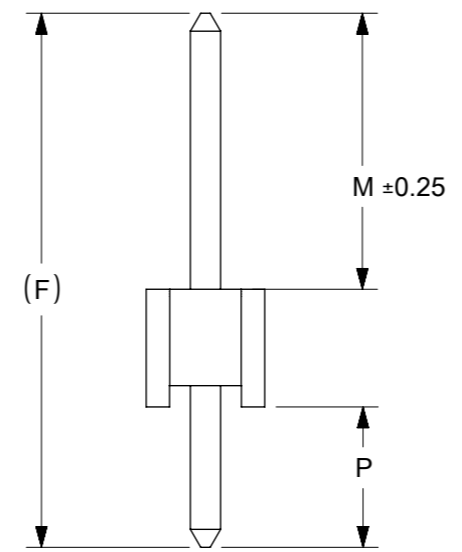
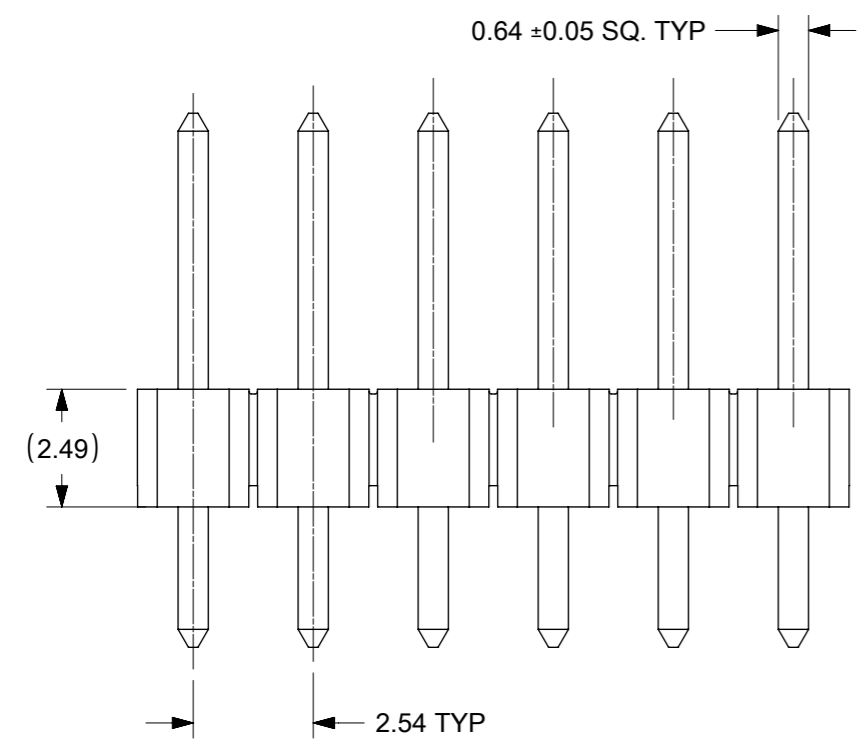

ISOMERTIC VIEW FOR 6CKT HEADER

NOTES

1. MATERIAL:
HSG: NYLON, GLASS-FILLED, UL94V-0 COLOR: BLACK
PIN: 0.64MM SQ, COPPER ALLOY
2. PLATING TYPE:
 - (1) GOLD FLASH OVER
1.270µm MIN. NICKEL OVERALL.
 - (2) GOLD FLASH ON CONTACT AND
1.905µm MIN. TIN ON SOLDER TAIL OVER
1.270µm MIN. NICKEL OVERALL.
 - (3) 0.254µm MIN. GOLD PLATE ON CONTACT AND
1.905µm MIN. TIN ON SOLDER TAIL OVER
1.270µm MIN. NICKEL OVERALL.
 - (4) 0.381µm MIN. GOLD PLATE ON CONTACT AND
1.905µm MIN. TIN ON SOLDER TAIL OVER
1.270µm MIN. NICKEL OVERALL.
 - (5) 0.762µm MIN. GOLD PLATE ON CONTACT AND
1.905µm MIN. TIN ON SOLDER TAIL OVER
1.270µm MIN. NICKEL OVERALL.
 - (6) 2.540µm/100µin MIN TIN OVERALL
1.270µm/50µin NICKEL OVERALL
3. PRODUCT SPECIFICATION: PS-87920-019
4. PACKAGING TYPE: SEE TABLE
5. WAFER TO BE FLAT WITHIN 0.003 mm/mm
6. RECOMMENDED PCB THICKNESS IS 1.60mm±0.10
- △ IRREGULAR CIRCUIT CUTOFF WITHIN BREAKAWAY SECTION IS PERMISSIBLE. CUTTING OR CHIPPING OF THE MAIN BODY IS NOT ACCEPTABLE
8. THE ABOVE CKT 6 IS FOR ILLUSTRATION PURPOSE ONLY
9. PACKAGING SPECIFICATION:
TRAY: PK-89990-489
BULK: PK-89990-491

| | | | | | | | |
|---|-------|--------------------------------|---------|----------------------------|-----------------|---|----------------|
| THIS DRAWING CONTAINS INFORMATION THAT IS PROPRIETARY TO MOLEX ELECTRONIC TECHNOLOGIES, LLC AND SHOULD NOT BE USED WITHOUT WRITTEN PERMISSION | | CURRENT REV DESC: | | molex | | | |
| DIMENSION UNITS | SCALE | | | | | CUSTOM HEADER 2.54MM PITCH, SINGLE ROW SINGLE WAFER, T/H HEADER | |
| mm | NTS | | | PRODUCT CUSTOMER DRAWING | | | |
| GENERAL TOLERANCES (UNLESS SPECIFIED) | | EC NO: 679909 | | DOCUMENT NUMBER | | | |
| ANGULAR TOL ± 3.0 ° | | DRWN: AKUMAR19 2021/10/08 | | SD-87891-013 | | | |
| 4 PLACES ± | | CHK'D: MRAMAKRISHNA 2021/10/11 | | DOC TYPE DOC PART REVISION | | | |
| 3 PLACES ± | | APPR: MRAMAKRISHNA 2021/10/11 | | PSD 001 B5 | | | |
| 2 PLACES ± 0.2 | | INITIAL REVISION: | | | | | |
| 1 PLACE ± | | DRWN: YLQIAO 2004/12/06 | | | | | |
| 0 PLACES ± | | APPR: SLOW 2004/12/07 | | | | | |
| DRAFT WHERE APPLICABLE MUST REMAIN WITHIN DIMENSIONS | | THIRD ANGLE PROJECTION | DRAWING | SERIES | MATERIAL NUMBER | CUSTOMER | SHEET NUMBER |
| | | ⊕ | — | A3-SIZE | 87891 | SEE TABLE | GENERAL MARKET |
| | | | | | | | 1 OF 8 |

| 10 | 9 | | | 8 | 7 | 6 | 5 | 4 | 3 | 2 | 1 |
|-----------------|---------------------------|------------------|----------|---------------|--------------|------|------|-------|------|------|---|
| | PACKAGING OPTION PART NO. | | | | | | | | | | |
| TRAY | BULK | TUBE WITHOUT CAP | CKT SIZE | VOID POSITION | PLATING TYPE | A | B | F | M | P | |
| 87891-0101 | --- | --- | 1 | --- | 1 | 2.54 | --- | 11.30 | 5.84 | 2.97 | |
| 87891-0102 | --- | --- | 1 | --- | 2 | 2.54 | --- | 11.30 | 5.84 | 2.97 | |
| 87891-0103 | --- | --- | 1 | --- | 3 | 2.54 | --- | 11.30 | 5.84 | 2.97 | |
| 87891-0104 | --- | --- | 1 | --- | 4 | 2.54 | --- | 11.30 | 5.84 | 2.97 | |
| 87891-0105 | --- | --- | 1 | --- | 5 | 2.54 | --- | 11.30 | 5.84 | 2.97 | |
| 87891-0106 | --- | --- | 1 | --- | 6 | 2.54 | --- | 11.30 | 5.84 | 2.97 | |
| (B4) 87891-0109 | --- | --- | 1 | --- | 6 | 2.54 | --- | 11.30 | 5.84 | 2.97 | |
| | | | | | | | | | | | |
| | | | | | | | | | | | |
| 87891-0201 | --- | --- | 2 | --- | 1 | 5.08 | 2.54 | 11.30 | 5.84 | 2.97 | |
| 87891-0202 | --- | --- | 2 | --- | 2 | 5.08 | 2.54 | 11.30 | 5.84 | 2.97 | |
| 87891-0203 | --- | --- | 2 | --- | 3 | 5.08 | 2.54 | 11.30 | 5.84 | 2.97 | |
| 87891-0204 | --- | --- | 2 | --- | 4 | 5.08 | 2.54 | 11.30 | 5.84 | 2.97 | |
| 87891-0205 | --- | --- | 2 | --- | 5 | 5.08 | 2.54 | 11.30 | 5.84 | 2.97 | |
| 87891-0206 | --- | --- | 2 | --- | 6 | 5.08 | 2.54 | 11.30 | 5.84 | 2.97 | |
| (B4) 87891-0211 | --- | --- | 2 | --- | 6 | 5.08 | 2.54 | 11.30 | 5.84 | 2.97 | |
| | | | | | | | | | | | |
| | | | | | | | | | | | |
| 87891-0301 | --- | --- | 3 | --- | 1 | 7.62 | 5.08 | 11.30 | 5.84 | 2.97 | |
| 87891-0302 | --- | --- | 3 | --- | 2 | 7.62 | 5.08 | 11.30 | 5.84 | 2.97 | |
| 87891-0303 | --- | --- | 3 | --- | 3 | 7.62 | 5.08 | 11.30 | 5.84 | 2.97 | |
| 87891-0304 | --- | --- | 3 | --- | 4 | 7.62 | 5.08 | 11.30 | 5.84 | 2.97 | |
| 87891-0305 | --- | --- | 3 | --- | 5 | 7.62 | 5.08 | 11.30 | 5.84 | 2.97 | |
| 87891-0306 | --- | --- | 3 | --- | 6 | 7.62 | 5.08 | 11.30 | 5.84 | 2.97 | |
| (B4) 87891-0308 | --- | --- | 3 | --- | 6 | 7.62 | 5.08 | 11.30 | 5.84 | 2.97 | |
| | | | | | | | | | | | |
| | | | | | | | | | | | |

| 10 | 9 | | | 8 | 7 | 6 | 5 | 4 | 3 | 2 | 1 |
|-----------------|---------------------------|------------------|----------|---------------|--------------|-------|-------|-------|------|------|---|
| | PACKAGING OPTION PART NO. | | | | | | | | | | |
| TRAY | BULK | TUBE WITHOUT CAP | CKT SIZE | VOID POSITION | PLATING TYPE | A | B | F | M | P | |
| 87891-0401 | --- | --- | 4 | --- | 1 | 10.16 | 7.62 | 11.30 | 5.84 | 2.97 | |
| 87891-0412 | --- | --- | 4 | --- | 2 | 10.16 | 7.62 | 11.30 | 5.84 | 2.97 | |
| 87891-0403 | --- | --- | 4 | --- | 3 | 10.16 | 7.62 | 11.30 | 5.84 | 2.97 | |
| 87891-0404 | --- | --- | 4 | --- | 4 | 10.16 | 7.62 | 11.30 | 5.84 | 2.97 | |
| 87891-0405 | --- | --- | 4 | --- | 5 | 10.16 | 7.62 | 11.30 | 5.84 | 2.97 | |
| 87891-0406 | --- | --- | 4 | --- | 6 | 10.16 | 7.62 | 11.30 | 5.84 | 2.97 | |
| | | | | | | | | | | | |
| | | | | | | | | | | | |
| 87891-0511 | --- | --- | 5 | --- | 1 | 12.70 | 10.16 | 11.30 | 5.84 | 2.97 | |
| 87891-0512 | --- | --- | 5 | --- | 2 | 12.70 | 10.16 | 11.30 | 5.84 | 2.97 | |
| 87891-0513 | --- | --- | 5 | --- | 3 | 12.70 | 10.16 | 11.30 | 5.84 | 2.97 | |
| 87891-0514 | --- | --- | 5 | --- | 4 | 12.70 | 10.16 | 11.30 | 5.84 | 2.97 | |
| 87891-0515 | --- | --- | 5 | --- | 5 | 12.70 | 10.16 | 11.30 | 5.84 | 2.97 | |
| 87891-0506 | --- | --- | 5 | --- | 6 | 12.70 | 10.16 | 11.30 | 5.84 | 2.97 | |
| (B4) 87891-0509 | --- | --- | 5 | --- | 6 | 12.70 | 10.16 | 11.30 | 5.84 | 2.97 | |
| | | | | | | | | | | | |
| | | | | | | | | | | | |
| 87891-0601 | --- | --- | 6 | --- | 1 | 15.24 | 12.70 | 11.30 | 5.84 | 2.97 | |
| 87891-0612 | --- | --- | 6 | --- | 2 | 15.24 | 12.70 | 11.30 | 5.84 | 2.97 | |
| 87891-0603 | --- | --- | 6 | --- | 3 | 15.24 | 12.70 | 11.30 | 5.84 | 2.97 | |
| 87891-0604 | --- | --- | 6 | --- | 4 | 15.24 | 12.70 | 11.30 | 5.84 | 2.97 | |
| 87891-0605 | --- | --- | 6 | --- | 5 | 15.24 | 12.70 | 11.30 | 5.84 | 2.97 | |
| 87891-0606 | --- | --- | 6 | --- | 6 | 15.24 | 12.70 | 11.30 | 5.84 | 2.97 | |
| (B4) 87891-0610 | --- | --- | 6 | --- | 6 | 15.24 | 12.70 | 11.30 | 5.84 | 2.97 | |
| | | | | | | | | | | | |
| | | | | | | | | | | | |

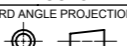
| | | | | | | | | | | | | | | | | | | | |
|---|--|-------|--|--|--|----------------|--|--------|--|---|--|---|--|----------|--|--------------|--|----------|--|
| THIS DRAWING CONTAINS INFORMATION THAT IS PROPRIETARY TO MOLEX ELECTRONIC TECHNOLOGIES, LLC AND SHOULD NOT BE USED WITHOUT WRITTEN PERMISSION | | | | | | | | | | | | | | | | | | | |
| DIMENSION UNITS | | SCALE | | CURRENT REV DESC: | | | | | |  | | | | | | | | | |
| mm | | NTS | | | | | | | | | | | | | | | | | |
| GENERAL TOLERANCES (UNLESS SPECIFIED) | | | | EC NO: 679909 DRWN: AKUMAR19 2021/10/08 CHK'D: MRAMAKRISHNA 2021/10/11 APPR: MRAMAKRISHNA 2021/10/11 INITIAL REVISION: DRWN: YLQIAO 2004/12/06 APPR: SLOW 2004/12/07 | | | | | | | | CUSTOM HEADER | | | | | | | |
| ANGULAR TOL ± 3.0 ° | | | | | | | | | | | | 2.54MM PITCH, SINGLE ROW SINGLE WAFER, T/H HEADER | | | | | | | |
| 4 PLACES ± | | 0.2 | | | | | | | | | | PRODUCT CUSTOMER DRAWING | | | | | | | |
| 3 PLACES ± | | 0.2 | | | | | | | | | | DOCUMENT NUMBER | | DOC TYPE | | DOC PART | | REVISION | |
| 2 PLACES ± | | 0.2 | | | | | | | | | | SD-87891-013 | | PSD | | 001 | | B5 | |
| 1 PLACE ± | | 0.2 | | | | | | | | | | MATERIAL NUMBER | | CUSTOMER | | SHEET NUMBER | | | |
| 0 PLACES ± | | 0.2 | | SEE TABLE | | GENERAL MARKET | | 2 OF 8 | | | | | | | | | | | |
| DRAFT WHERE APPLICABLE MUST REMAIN WITHIN DIMENSIONS | | | | THIRD ANGLE PROJECTION | | DRAWING | | SERIES | | MATERIAL NUMBER | | | | | | | | | |
| | | | |  | | A3-SIZE | | 87891 | | | | | | | | | | | |

| PACKAGING OPTION PART NO. | | | CKT SIZE | VOID POSITION | PLATING TYPE | DIMENSION | | | | |
|---------------------------|------|------------------|----------|---------------|--------------|-----------|-------|-------|------|------|
| TRAY | BULK | TUBE WITHOUT CAP | | | | A | B | F | M | P |
| 87891-0711 | --- | --- | 7 | --- | 1 | 17.78 | 15.24 | 11.30 | 5.84 | 2.97 |
| 87891-0702 | --- | --- | 7 | --- | 2 | 17.78 | 15.24 | 11.30 | 5.84 | 2.97 |
| 87891-0703 | --- | --- | 7 | --- | 3 | 17.78 | 15.24 | 11.30 | 5.84 | 2.97 |
| 87891-0704 | --- | --- | 7 | --- | 4 | 17.78 | 15.24 | 11.30 | 5.84 | 2.97 |
| 87891-0705 | --- | --- | 7 | --- | 5 | 17.78 | 15.24 | 11.30 | 5.84 | 2.97 |
| 87891-0706 | --- | --- | 7 | --- | 6 | 17.78 | 15.24 | 11.30 | 5.84 | 2.97 |
| | | | | | | | | | | |
| | | | | | | | | | | |
| 87891-0801 | --- | --- | 8 | --- | 1 | 20.32 | 17.78 | 11.30 | 5.84 | 2.97 |
| 87891-0802 | --- | --- | 8 | --- | 2 | 20.32 | 17.78 | 11.30 | 5.84 | 2.97 |
| 87891-0803 | --- | --- | 8 | --- | 3 | 20.32 | 17.78 | 11.30 | 5.84 | 2.97 |
| 87891-0804 | --- | --- | 8 | --- | 4 | 20.32 | 17.78 | 11.30 | 5.84 | 2.97 |
| 87891-0805 | --- | --- | 8 | --- | 5 | 20.32 | 17.78 | 11.30 | 5.84 | 2.97 |
| 87891-0806 | --- | --- | 8 | --- | 6 | 20.32 | 17.78 | 11.30 | 5.84 | 2.97 |
| | | | | | | | | | | |
| | | | | | | | | | | |
| 87891-0901 | --- | --- | 9 | --- | 1 | 22.86 | 20.32 | 11.30 | 5.84 | 2.97 |
| 87891-0902 | --- | --- | 9 | --- | 2 | 22.86 | 20.32 | 11.30 | 5.84 | 2.97 |
| 87891-0903 | --- | --- | 9 | --- | 3 | 22.86 | 20.32 | 11.30 | 5.84 | 2.97 |
| 87891-0904 | --- | --- | 9 | --- | 4 | 22.86 | 20.32 | 11.30 | 5.84 | 2.97 |
| 87891-0905 | --- | --- | 9 | --- | 5 | 22.86 | 20.32 | 11.30 | 5.84 | 2.97 |
| 87891-0906 | --- | --- | 9 | --- | 6 | 22.86 | 20.32 | 11.30 | 5.84 | 2.97 |
| | | | | | | | | | | |
| | | | | | | | | | | |

| PACKAGING OPTION PART NO. | | | CKT SIZE | VOID POSITION | PLATING TYPE | DIMENSION | | | | |
|---------------------------|------|------------------|----------|---------------|--------------|-----------|-------|-------|------|------|
| TRAY | BULK | TUBE WITHOUT CAP | | | | A | B | F | M | P |
| 87891-1001 | --- | --- | 10 | --- | 1 | 25.40 | 22.86 | 11.30 | 5.84 | 2.97 |
| 87891-1002 | --- | --- | 10 | --- | 2 | 25.40 | 22.86 | 11.30 | 5.84 | 2.97 |
| 87891-1003 | --- | --- | 10 | --- | 3 | 25.40 | 22.86 | 11.30 | 5.84 | 2.97 |
| 87891-1004 | --- | --- | 10 | --- | 4 | 25.40 | 22.86 | 11.30 | 5.84 | 2.97 |
| 87891-1005 | --- | --- | 10 | --- | 5 | 25.40 | 22.86 | 11.30 | 5.84 | 2.97 |
| 87891-1006 | --- | --- | 10 | --- | 6 | 25.40 | 22.86 | 11.30 | 5.84 | 2.97 |
| | | | | | | | | | | |
| | | | | | | | | | | |
| 87891-1101 | --- | --- | 11 | --- | 1 | 27.94 | 25.40 | 11.30 | 5.84 | 2.97 |
| 87891-1102 | --- | --- | 11 | --- | 2 | 27.94 | 25.40 | 11.30 | 5.84 | 2.97 |
| 87891-1103 | --- | --- | 11 | --- | 3 | 27.94 | 25.40 | 11.30 | 5.84 | 2.97 |
| 87891-1104 | --- | --- | 11 | --- | 4 | 27.94 | 25.40 | 11.30 | 5.84 | 2.97 |
| 87891-1105 | --- | --- | 11 | --- | 5 | 27.94 | 25.40 | 11.30 | 5.84 | 2.97 |
| 87891-1106 | --- | --- | 11 | --- | 6 | 27.94 | 25.40 | 11.30 | 5.84 | 2.97 |
| | | | | | | | | | | |
| | | | | | | | | | | |
| 87891-1201 | --- | --- | 12 | --- | 1 | 30.48 | 27.94 | 11.30 | 5.84 | 2.97 |
| 87891-1202 | --- | --- | 12 | --- | 2 | 30.48 | 27.94 | 11.30 | 5.84 | 2.97 |
| 87891-1203 | --- | --- | 12 | --- | 3 | 30.48 | 27.94 | 11.30 | 5.84 | 2.97 |
| 87891-1204 | --- | --- | 12 | --- | 4 | 30.48 | 27.94 | 11.30 | 5.84 | 2.97 |
| 87891-1205 | --- | --- | 12 | --- | 5 | 30.48 | 27.94 | 11.30 | 5.84 | 2.97 |
| 87891-1206 | --- | --- | 12 | --- | 6 | 30.48 | 27.94 | 11.30 | 5.84 | 2.97 |
| | | | | | | | | | | |
| | | | | | | | | | | |

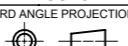
| | | | | | | | | | |
|---|--|-------|--|---|--|-----------------|--|---|--|
| THIS DRAWING CONTAINS INFORMATION THAT IS PROPRIETARY TO MOLEX ELECTRONIC TECHNOLOGIES, LLC AND SHOULD NOT BE USED WITHOUT WRITTEN PERMISSION | | | | | | | | | |
| DIMENSION UNITS | | SCALE | | CURRENT REV DESC: | | | |  | |
| mm | | NTS | | | | | | | |
| GENERAL TOLERANCES (UNLESS SPECIFIED) | | | | EC NO: 679909 | | | | CUSTOM HEADER 2.54MM PITCH, SINGLE ROW SINGLE WAFER, T/H HEADER | |
| ANGULAR TOL ± 3.0 ° | | | | DRWN: AKUMAR19 2021/10/08 | | | | | |
| 4 PLACES ± | | | | CHK'D: MRAMAKRISHNA 2021/10/11 | | | | PRODUCT CUSTOMER DRAWING | |
| 3 PLACES ± | | | | APPR: MRAMAKRISHNA 2021/10/11 | | | | | |
| 2 PLACES ± 0.2 | | | | INITIAL REVISION: | | | | DOCUMENT NUMBER | |
| 1 PLACE ± | | | | DRWN: YLQIAO 2004/12/06 | | | | SD-87891-013 | |
| 0 PLACES ± | | | | APPR: SLOW 2004/12/07 | | | | DOC TYPE DOC PART REVISION | |
| DRAFT WHERE APPLICABLE MUST REMAIN WITHIN DIMENSIONS | | | | THIRD ANGLE PROJECTION | | DRAWING | | SHEET NUMBER | |
| | | | |  | | A3-SIZE | | 3 OF 8 | |
| | | | | SERIES | | MATERIAL NUMBER | | CUSTOMER | |
| | | | | 87891 | | SEE TABLE | | GENERAL MARKET | |

| | | | | |
|-----------------|----|--------------|------------|----------|
| DOCUMENT STATUS | P1 | RELEASE DATE | 2021/10/11 | 11:53:25 |
|-----------------|----|--------------|------------|----------|

| | PACKAGING OPTION PART NO. | | | CKT SIZE | VOID POSITION | PLATING TYPE | DIMENSION | | | | |
|---|---------------------------|------|------------------|----------|---------------|--------------|-----------|-------|-------|------|------|
| | TRAY | BULK | TUBE WITHOUT CAP | | | | A | B | F | M | P |
| F | 87891-1301 | --- | --- | 13 | --- | 1 | 33.02 | 30.48 | 11.30 | 5.84 | 2.97 |
| | 87891-1302 | --- | --- | 13 | --- | 2 | 33.02 | 30.48 | 11.30 | 5.84 | 2.97 |
| | 87891-1303 | --- | --- | 13 | --- | 3 | 33.02 | 30.48 | 11.30 | 5.84 | 2.97 |
| | 87891-1304 | --- | --- | 13 | --- | 4 | 33.02 | 30.48 | 11.30 | 5.84 | 2.97 |
| | 87891-1305 | --- | --- | 13 | --- | 5 | 33.02 | 30.48 | 11.30 | 5.84 | 2.97 |
| | 87891-1306 | --- | --- | 13 | --- | 6 | 33.02 | 30.48 | 11.30 | 5.84 | 2.97 |
| | | | | | | | | | | | |
| | | | | | | | | | | | |
| E | 87891-1401 | --- | --- | 14 | --- | 1 | 35.56 | 33.02 | 11.30 | 5.84 | 2.97 |
| | 87891-1402 | --- | --- | 14 | --- | 2 | 35.56 | 33.02 | 11.30 | 5.84 | 2.97 |
| | 87891-1403 | --- | --- | 14 | --- | 3 | 35.56 | 33.02 | 11.30 | 5.84 | 2.97 |
| | 87891-1404 | --- | --- | 14 | --- | 4 | 35.56 | 33.02 | 11.30 | 5.84 | 2.97 |
| | 87891-1405 | --- | --- | 14 | --- | 5 | 35.56 | 33.02 | 11.30 | 5.84 | 2.97 |
| | 87891-1406 | --- | --- | 14 | --- | 6 | 35.56 | 33.02 | 11.30 | 5.84 | 2.97 |
| | | | | | | | | | | | |
| | | | | | | | | | | | |
| D | 87891-1501 | --- | --- | 15 | --- | 1 | 38.10 | 35.56 | 11.30 | 5.84 | 2.97 |
| | 87891-1502 | --- | --- | 15 | --- | 2 | 38.10 | 35.56 | 11.30 | 5.84 | 2.97 |
| | 87891-1503 | --- | --- | 15 | --- | 3 | 38.10 | 35.56 | 11.30 | 5.84 | 2.97 |
| | 87891-1504 | --- | --- | 15 | --- | 4 | 38.10 | 35.56 | 11.30 | 5.84 | 2.97 |
| | 87891-1505 | --- | --- | 15 | --- | 5 | 38.10 | 35.56 | 11.30 | 5.84 | 2.97 |
| | 87891-1506 | --- | --- | 15 | --- | 6 | 38.10 | 35.56 | 11.30 | 5.84 | 2.97 |
| | | | | | | | | | | | |
| | | | | | | | | | | | |

| | PACKAGING OPTION PART NO. | | | CKT SIZE | VOID POSITION | PLATING TYPE | DIMENSION | | | | |
|---|---------------------------|------|------------------|----------|---------------|--------------|-----------|-------|-------|------|------|
| | TRAY | BULK | TUBE WITHOUT CAP | | | | A | B | F | M | P |
| F | 87891-1601 | --- | --- | 16 | --- | 1 | 40.64 | 38.10 | 11.30 | 5.84 | 2.97 |
| | 87891-1602 | --- | --- | 16 | --- | 2 | 40.64 | 38.10 | 11.30 | 5.84 | 2.97 |
| | 87891-1603 | --- | --- | 16 | --- | 3 | 40.64 | 38.10 | 11.30 | 5.84 | 2.97 |
| | 87891-1604 | --- | --- | 16 | --- | 4 | 40.64 | 38.10 | 11.30 | 5.84 | 2.97 |
| | 87891-1605 | --- | --- | 16 | --- | 5 | 40.64 | 38.10 | 11.30 | 5.84 | 2.97 |
| | 87891-1606 | --- | --- | 16 | --- | 6 | 40.64 | 38.10 | 11.30 | 5.84 | 2.97 |
| | | | | | | | | | | | |
| | | | | | | | | | | | |
| E | 87891-1701 | --- | --- | 17 | --- | 1 | 43.18 | 40.64 | 11.30 | 5.84 | 2.97 |
| | 87891-1702 | --- | --- | 17 | --- | 2 | 43.18 | 40.64 | 11.30 | 5.84 | 2.97 |
| | 87891-1703 | --- | --- | 17 | --- | 3 | 43.18 | 40.64 | 11.30 | 5.84 | 2.97 |
| | 87891-1704 | --- | --- | 17 | --- | 4 | 43.18 | 40.64 | 11.30 | 5.84 | 2.97 |
| | 87891-1705 | --- | --- | 17 | --- | 5 | 43.18 | 40.64 | 11.30 | 5.84 | 2.97 |
| | 87891-1706 | --- | --- | 17 | --- | 6 | 43.18 | 40.64 | 11.30 | 5.84 | 2.97 |
| | | | | | | | | | | | |
| | | | | | | | | | | | |
| D | 87891-1801 | --- | --- | 18 | --- | 1 | 45.72 | 43.18 | 11.30 | 5.84 | 2.97 |
| | 87891-1802 | --- | --- | 18 | --- | 2 | 45.72 | 43.18 | 11.30 | 5.84 | 2.97 |
| | 87891-1803 | --- | --- | 18 | --- | 3 | 45.72 | 43.18 | 11.30 | 5.84 | 2.97 |
| | 87891-1804 | --- | --- | 18 | --- | 4 | 45.72 | 43.18 | 11.30 | 5.84 | 2.97 |
| | 87891-1805 | --- | --- | 18 | --- | 5 | 45.72 | 43.18 | 11.30 | 5.84 | 2.97 |
| | 87891-1806 | --- | --- | 18 | --- | 6 | 45.72 | 43.18 | 11.30 | 5.84 | 2.97 |
| | | | | | | | | | | | |
| | | | | | | | | | | | |

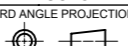
| | | | | | | | | | | | | | | | | | |
|---|--|---------|--|--|--|---------|--|--------|--|---|--|----------------|--|--------------|--|----------|--|
| THIS DRAWING CONTAINS INFORMATION THAT IS PROPRIETARY TO MOLEX ELECTRONIC TECHNOLOGIES, LLC AND SHOULD NOT BE USED WITHOUT WRITTEN PERMISSION | | | | | | | | | | | | | | | | | |
| DIMENSION UNITS | | SCALE | | CURRENT REV DESC: | | | | | |  | | | | | | | |
| mm | | NTS | | | | | | | | | | | | | | | |
| GENERAL TOLERANCES (UNLESS SPECIFIED) | | | | EC NO: 679909 DRWN: AKUMAR19 2021/10/08 CHK'D: MRAMAKRISHNA 2021/10/11 APPR: MRAMAKRISHNA 2021/10/11 INITIAL REVISION: DRWN: YLQIAO 2004/12/06 APPR: SLOW 2004/12/07 | | | | | | CUSTOMER DRAWING | | | | | | | |
| ANGULAR TOL | | ± 3.0 ° | | | | | | | | DOCUMENT NUMBER | | DOC TYPE | | DOC PART | | REVISION | |
| 4 PLACES | | ± | | | | | | | | SD-87891-013 | | PSD | | 001 | | B5 | |
| 3 PLACES | | ± | | | | | | | | MATERIAL NUMBER | | CUSTOMER | | SHEET NUMBER | | | |
| 2 PLACES | | ± 0.2 | | | | | | | | SEE TABLE | | GENERAL MARKET | | 4 OF 8 | | | |
| 1 PLACE | | ± | | | | | | | | | | | | | | | |
| 0 PLACES | | ± | | | | | | | | | | | | | | | |
| DRAFT WHERE APPLICABLE MUST REMAIN WITHIN DIMENSIONS | | | | THIRD ANGLE PROJECTION | | DRAWING | | SERIES | | | | | | | | | |
| | | | |  | | A3-SIZE | | 87891 | | | | | | | | | |

| | | | | |
|-----------------|----|--------------|------------|----------|
| DOCUMENT STATUS | P1 | RELEASE DATE | 2021/10/11 | 11:53:25 |
|-----------------|----|--------------|------------|----------|

| | PACKAGING OPTION PART NO. | | | CKT SIZE | VOID POSITION | PLATING TYPE | DIMENSION | | | | |
|---|---------------------------|------|------------------|----------|---------------|--------------|-----------|-------|-------|------|------|
| | TRAY | BULK | TUBE WITHOUT CAP | | | | A | B | F | M | P |
| F | 87891-1901 | --- | --- | 19 | --- | 1 | 48.26 | 45.72 | 11.30 | 5.84 | 2.97 |
| | 87891-1902 | --- | --- | 19 | --- | 2 | 48.26 | 45.72 | 11.30 | 5.84 | 2.97 |
| | 87891-1903 | --- | --- | 19 | --- | 3 | 48.26 | 45.72 | 11.30 | 5.84 | 2.97 |
| | 87891-1904 | --- | --- | 19 | --- | 4 | 48.26 | 45.72 | 11.30 | 5.84 | 2.97 |
| | 87891-1905 | --- | --- | 19 | --- | 5 | 48.26 | 45.72 | 11.30 | 5.84 | 2.97 |
| | 87891-1906 | --- | --- | 19 | --- | 6 | 48.26 | 45.72 | 11.30 | 5.84 | 2.97 |
| | | | | | | | | | | | |
| | | | | | | | | | | | |
| E | 87891-2001 | --- | --- | 20 | --- | 1 | 50.80 | 48.26 | 11.30 | 5.84 | 2.97 |
| | 87891-2002 | --- | --- | 20 | --- | 2 | 50.80 | 48.26 | 11.30 | 5.84 | 2.97 |
| | 87891-2003 | --- | --- | 20 | --- | 3 | 50.80 | 48.26 | 11.30 | 5.84 | 2.97 |
| | 87891-2004 | --- | --- | 20 | --- | 4 | 50.80 | 48.26 | 11.30 | 5.84 | 2.97 |
| | 87891-2005 | --- | --- | 20 | --- | 5 | 50.80 | 48.26 | 11.30 | 5.84 | 2.97 |
| | 87891-2006 | --- | --- | 20 | --- | 6 | 50.80 | 48.26 | 11.30 | 5.84 | 2.97 |
| | | | | | | | | | | | |
| | | | | | | | | | | | |
| D | 87891-2101 | --- | --- | 21 | --- | 1 | 53.34 | 50.80 | 11.30 | 5.84 | 2.97 |
| | 87891-2102 | --- | --- | 21 | --- | 2 | 53.34 | 50.80 | 11.30 | 5.84 | 2.97 |
| | 87891-2103 | --- | --- | 21 | --- | 3 | 53.34 | 50.80 | 11.30 | 5.84 | 2.97 |
| | 87891-2104 | --- | --- | 21 | --- | 4 | 53.34 | 50.80 | 11.30 | 5.84 | 2.97 |
| | 87891-2105 | --- | --- | 21 | --- | 5 | 53.34 | 50.80 | 11.30 | 5.84 | 2.97 |
| | 87891-2106 | --- | --- | 21 | --- | 6 | 53.34 | 50.80 | 11.30 | 5.84 | 2.97 |
| | | | | | | | | | | | |
| | | | | | | | | | | | |

| | PACKAGING OPTION PART NO. | | | CKT SIZE | VOID POSITION | PLATING TYPE | DIMENSION | | | | |
|---|---------------------------|------|------------------|----------|---------------|--------------|-----------|-------|-------|------|------|
| | TRAY | BULK | TUBE WITHOUT CAP | | | | A | B | F | M | P |
| F | 87891-2201 | --- | --- | 22 | --- | 1 | 55.88 | 53.34 | 11.30 | 5.84 | 2.97 |
| | 87891-2202 | --- | --- | 22 | --- | 2 | 55.88 | 53.34 | 11.30 | 5.84 | 2.97 |
| | 87891-2203 | --- | --- | 22 | --- | 3 | 55.88 | 53.34 | 11.30 | 5.84 | 2.97 |
| | 87891-2204 | --- | --- | 22 | --- | 4 | 55.88 | 53.34 | 11.30 | 5.84 | 2.97 |
| | 87891-2205 | --- | --- | 22 | --- | 5 | 55.88 | 53.34 | 11.30 | 5.84 | 2.97 |
| | 87891-2206 | --- | --- | 22 | --- | 6 | 55.88 | 53.34 | 11.30 | 5.84 | 2.97 |
| | | | | | | | | | | | |
| | | | | | | | | | | | |
| E | 87891-2301 | --- | --- | 23 | --- | 1 | 58.42 | 55.88 | 11.30 | 5.84 | 2.97 |
| | 87891-2302 | --- | --- | 23 | --- | 2 | 58.42 | 55.88 | 11.30 | 5.84 | 2.97 |
| | 87891-2303 | --- | --- | 23 | --- | 3 | 58.42 | 55.88 | 11.30 | 5.84 | 2.97 |
| | 87891-2304 | --- | --- | 23 | --- | 4 | 58.42 | 55.88 | 11.30 | 5.84 | 2.97 |
| | 87891-2305 | --- | --- | 23 | --- | 5 | 58.42 | 55.88 | 11.30 | 5.84 | 2.97 |
| | 87891-2306 | --- | --- | 23 | --- | 6 | 58.42 | 55.88 | 11.30 | 5.84 | 2.97 |
| | | | | | | | | | | | |
| | | | | | | | | | | | |
| D | 87891-2401 | --- | --- | 24 | --- | 1 | 60.96 | 58.42 | 11.30 | 5.84 | 2.97 |
| | 87891-2402 | --- | --- | 24 | --- | 2 | 60.96 | 58.42 | 11.30 | 5.84 | 2.97 |
| | 87891-2403 | --- | --- | 24 | --- | 3 | 60.96 | 58.42 | 11.30 | 5.84 | 2.97 |
| | 87891-2404 | --- | --- | 24 | --- | 4 | 60.96 | 58.42 | 11.30 | 5.84 | 2.97 |
| | 87891-2405 | --- | --- | 24 | --- | 5 | 60.96 | 58.42 | 11.30 | 5.84 | 2.97 |
| | 87891-2406 | --- | --- | 24 | --- | 6 | 60.96 | 58.42 | 11.30 | 5.84 | 2.97 |
| | | | | | | | | | | | |
| | | | | | | | | | | | |

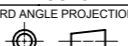
| | | | | | | | | | | | | | | | | | |
|---|--|-------|--|--|--|----------------|--|--------|--|---|--|----------|--|--------------|--|----------|--|
| THIS DRAWING CONTAINS INFORMATION THAT IS PROPRIETARY TO MOLEX ELECTRONIC TECHNOLOGIES, LLC AND SHOULD NOT BE USED WITHOUT WRITTEN PERMISSION | | | | | | | | | | | | | | | | | |
| DIMENSION UNITS | | SCALE | | CURRENT REV DESC: | | | | | |  | | | | | | | |
| mm | | NTS | | | | | | | | | | | | | | | |
| GENERAL TOLERANCES (UNLESS SPECIFIED) | | | | EC NO: 679909 DRWN: AKUMAR19 2021/10/08 CHK'D: MRAMAKRISHNA 2021/10/11 APPR: MRAMAKRISHNA 2021/10/11 INITIAL REVISION: DRWN: YLQIAO 2004/12/06 APPR: SLOW 2004/12/07 | | | | | | CUSTOM HEADER | | | | | | | |
| ANGULAR TOL ± 3.0 ° | | | | | | | | | | 2.54MM PITCH, SINGLE ROW SINGLE WAFER, T/H HEADER | | | | | | | |
| 4 PLACES ± | | | | | | | | | | PRODUCT CUSTOMER DRAWING | | | | | | | |
| 3 PLACES ± | | | | | | | | | | DOCUMENT NUMBER | | DOC TYPE | | DOC PART | | REVISION | |
| 2 PLACES ± 0.2 | | | | | | | | | | SD-87891-013 | | PSD | | 001 | | B5 | |
| 1 PLACE ± | | | | | | | | | | MATERIAL NUMBER | | CUSTOMER | | SHEET NUMBER | | | |
| 0 PLACES ± | | | | SEE TABLE | | GENERAL MARKET | | 5 OF 8 | | | | | | | | | |
| DRAFT WHERE APPLICABLE MUST REMAIN WITHIN DIMENSIONS | | | | THIRD ANGLE PROJECTION | | DRAWING | | SERIES | | | | | | | | | |
| | | | |  | | A3-SIZE | | 87891 | | | | | | | | | |

| | | | | |
|-----------------|----|--------------|------------|----------|
| DOCUMENT STATUS | P1 | RELEASE DATE | 2021/10/11 | 11:53:25 |
|-----------------|----|--------------|------------|----------|

| 10 | 9 | | | 8 | 7 | 6 | DIMENSION | | | | | | | |
|------------|---------------------------|------|------------------|-----|---|-------|-----------|---------------|--------------|------|---|---|---|---|
| | PACKAGING OPTION PART NO. | | | | | | CKT SIZE | VOID POSITION | PLATING TYPE | A | B | F | M | P |
| | TRAY | BULK | TUBE WITHOUT CAP | | | | | | | | | | | |
| 87891-2501 | --- | --- | 25 | --- | 1 | 63.50 | 60.96 | 11.30 | 5.84 | 2.97 | | | | |
| 87891-2502 | --- | --- | 25 | --- | 2 | 63.50 | 60.96 | 11.30 | 5.84 | 2.97 | | | | |
| 87891-2503 | --- | --- | 25 | --- | 3 | 63.50 | 60.96 | 11.30 | 5.84 | 2.97 | | | | |
| 87891-2504 | --- | --- | 25 | --- | 4 | 63.50 | 60.96 | 11.30 | 5.84 | 2.97 | | | | |
| 87891-2505 | --- | --- | 25 | --- | 5 | 63.50 | 60.96 | 11.30 | 5.84 | 2.97 | | | | |
| 87891-2506 | --- | --- | 25 | --- | 6 | 63.50 | 60.96 | 11.30 | 5.84 | 2.97 | | | | |
| --- | 87891-2611 | --- | 26 | --- | 1 | 66.04 | 63.50 | 11.30 | 5.84 | 2.97 | | | | |
| --- | 87891-2602 | --- | 26 | --- | 2 | 66.04 | 63.50 | 11.30 | 5.84 | 2.97 | | | | |
| --- | 87891-2603 | --- | 26 | --- | 3 | 66.04 | 63.50 | 11.30 | 5.84 | 2.97 | | | | |
| --- | 87891-2604 | --- | 26 | --- | 4 | 66.04 | 63.50 | 11.30 | 5.84 | 2.97 | | | | |
| --- | 87891-2605 | --- | 26 | --- | 5 | 66.04 | 63.50 | 11.30 | 5.84 | 2.97 | | | | |
| --- | 87891-2606 | --- | 26 | --- | 6 | 66.04 | 63.50 | 11.30 | 5.84 | 2.97 | | | | |
| --- | 87891-2701 | --- | 27 | --- | 1 | 68.58 | 66.04 | 11.30 | 5.84 | 2.97 | | | | |
| --- | 87891-2702 | --- | 27 | --- | 2 | 68.58 | 66.04 | 11.30 | 5.84 | 2.97 | | | | |
| --- | 87891-2703 | --- | 27 | --- | 3 | 68.58 | 66.04 | 11.30 | 5.84 | 2.97 | | | | |
| --- | 87891-2704 | --- | 27 | --- | 4 | 68.58 | 66.04 | 11.30 | 5.84 | 2.97 | | | | |
| --- | 87891-2705 | --- | 27 | --- | 5 | 68.58 | 66.04 | 11.30 | 5.84 | 2.97 | | | | |
| --- | 87891-2706 | --- | 27 | --- | 6 | 68.58 | 66.04 | 11.30 | 5.84 | 2.97 | | | | |

| 5 | 4 | | | 3 | 2 | 1 | DIMENSION | | | | | | | |
|-----|---------------------------|------|------------------|-----|---|-------|-----------|---------------|--------------|------|---|---|---|---|
| | PACKAGING OPTION PART NO. | | | | | | CKT SIZE | VOID POSITION | PLATING TYPE | A | B | F | M | P |
| | TRAY | BULK | TUBE WITHOUT CAP | | | | | | | | | | | |
| --- | 87891-2801 | --- | 28 | --- | 1 | 71.12 | 68.58 | 11.30 | 5.84 | 2.97 | | | | |
| --- | 87891-2802 | --- | 28 | --- | 2 | 71.12 | 68.58 | 11.30 | 5.84 | 2.97 | | | | |
| --- | 87891-2803 | --- | 28 | --- | 3 | 71.12 | 68.58 | 11.30 | 5.84 | 2.97 | | | | |
| --- | 87891-2804 | --- | 28 | --- | 4 | 71.12 | 68.58 | 11.30 | 5.84 | 2.97 | | | | |
| --- | 87891-2805 | --- | 28 | --- | 5 | 71.12 | 68.58 | 11.30 | 5.84 | 2.97 | | | | |
| --- | 87891-2806 | --- | 28 | --- | 6 | 71.12 | 68.58 | 11.30 | 5.84 | 2.97 | | | | |
| --- | 87891-2901 | --- | 29 | --- | 1 | 73.66 | 71.12 | 11.30 | 5.84 | 2.97 | | | | |
| --- | 87891-2902 | --- | 29 | --- | 2 | 73.66 | 71.12 | 11.30 | 5.84 | 2.97 | | | | |
| --- | 87891-2903 | --- | 29 | --- | 3 | 73.66 | 71.12 | 11.30 | 5.84 | 2.97 | | | | |
| --- | 87891-2904 | --- | 29 | --- | 4 | 73.66 | 71.12 | 11.30 | 5.84 | 2.97 | | | | |
| --- | 87891-2905 | --- | 29 | --- | 5 | 73.66 | 71.12 | 11.30 | 5.84 | 2.97 | | | | |
| --- | 87891-2906 | --- | 29 | --- | 6 | 73.66 | 71.12 | 11.30 | 5.84 | 2.97 | | | | |
| --- | 87891-3001 | --- | 30 | --- | 1 | 76.20 | 73.66 | 11.30 | 5.84 | 2.97 | | | | |
| --- | 87891-3002 | --- | 30 | --- | 2 | 76.20 | 73.66 | 11.30 | 5.84 | 2.97 | | | | |
| --- | 87891-3003 | --- | 30 | --- | 3 | 76.20 | 73.66 | 11.30 | 5.84 | 2.97 | | | | |
| --- | 87891-3004 | --- | 30 | --- | 4 | 76.20 | 73.66 | 11.30 | 5.84 | 2.97 | | | | |
| --- | 87891-3005 | --- | 30 | --- | 5 | 76.20 | 73.66 | 11.30 | 5.84 | 2.97 | | | | |
| --- | 87891-3006 | --- | 30 | --- | 6 | 76.20 | 73.66 | 11.30 | 5.84 | 2.97 | | | | |

| | | | | |
|-----------------|----|--------------|------------|----------|
| DOCUMENT STATUS | P1 | RELEASE DATE | 2021/10/11 | 11:53:25 |
|-----------------|----|--------------|------------|----------|

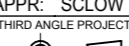
| | | | | | | | | | |
|---|--------------------------------|---------------------------|--|--|---|--|--|--|--|
| THIS DRAWING CONTAINS INFORMATION THAT IS PROPRIETARY TO MOLEX ELECTRONIC TECHNOLOGIES, LLC AND SHOULD NOT BE USED WITHOUT WRITTEN PERMISSION | | | | | | | | | |
| DIMENSION UNITS | SCALE | CURRENT REV DESC: | | |  CUSTOMER HEADER 2.54MM PITCH, SINGLE ROW SINGLE WAFER, T/H HEADER | | | | |
| mm | NTS | | | | | | | | |
| GENERAL TOLERANCES (UNLESS SPECIFIED) | | EC NO: 679909 | | | PRODUCT CUSTOMER DRAWING DOCUMENT NUMBER: SD-87891-013 DOC TYPE: PSD DOC PART: 001 REVISION: B5 | | | | |
| ANGULAR TOL ± 3.0 ° | | DRWN: AKUMAR19 2021/10/08 | | | | | | | |
| 4 PLACES ± | CHK'D: MRAMAKRISHNA 2021/10/11 | | | MATERIAL NUMBER: SEE TABLE CUSTOMER: GENERAL MARKET SHEET NUMBER: 6 OF 8 | | | | | |
| 3 PLACES ± | APPR: MRAMAKRISHNA 2021/10/11 | | | | | | | | |
| 2 PLACES ± 0.2 | INITIAL REVISION: | | | THIRD ANGLE PROJECTION:  DRAWING: A3-SIZE SERIES: 87891 | | | | | |
| 1 PLACE ± | DRWN: YLQIAO 2004/12/06 | | | | | | | | |
| 0 PLACES ± | APPR: SLOW 2004/12/07 | | | | | | | | |
| DRAFT WHERE APPLICABLE MUST REMAIN WITHIN DIMENSIONS | | | | | | | | | |

| | PACKAGING OPTION PART NO. | | | CKT SIZE | VOID POSITION | PLATING TYPE | DIMENSION | | | | |
|---|---------------------------|------------|------------------|----------|---------------|--------------|-----------|-------|-------|------|------|
| | TRAY | BULK | TUBE WITHOUT CAP | | | | A | B | F | M | P |
| F | --- | 87891-3101 | --- | 31 | --- | 1 | 78.74 | 76.20 | 11.30 | 5.84 | 2.97 |
| | --- | 87891-3102 | --- | 31 | --- | 2 | 78.74 | 76.20 | 11.30 | 5.84 | 2.97 |
| | --- | 87891-3103 | --- | 31 | --- | 3 | 78.74 | 76.20 | 11.30 | 5.84 | 2.97 |
| | --- | 87891-3104 | --- | 31 | --- | 4 | 78.74 | 76.20 | 11.30 | 5.84 | 2.97 |
| | --- | 87891-3105 | --- | 31 | --- | 5 | 78.74 | 76.20 | 11.30 | 5.84 | 2.97 |
| | --- | 87891-3106 | --- | 31 | --- | 6 | 78.74 | 76.20 | 11.30 | 5.84 | 2.97 |
| | | | | | | | | | | | |
| | | | | | | | | | | | |
| E | --- | 87891-3201 | --- | 32 | --- | 1 | 81.28 | 78.74 | 11.30 | 5.84 | 2.97 |
| | --- | 87891-3202 | --- | 32 | --- | 2 | 81.28 | 78.74 | 11.30 | 5.84 | 2.97 |
| | --- | 87891-3203 | --- | 32 | --- | 3 | 81.28 | 78.74 | 11.30 | 5.84 | 2.97 |
| | --- | 87891-3204 | --- | 32 | --- | 4 | 81.28 | 78.74 | 11.30 | 5.84 | 2.97 |
| | --- | 87891-3205 | --- | 32 | --- | 5 | 81.28 | 78.74 | 11.30 | 5.84 | 2.97 |
| | --- | 87891-3206 | --- | 32 | --- | 6 | 81.28 | 78.74 | 11.30 | 5.84 | 2.97 |
| | | | | | | | | | | | |
| | | | | | | | | | | | |
| D | --- | 87891-3301 | --- | 33 | --- | 1 | 83.82 | 81.28 | 11.30 | 5.84 | 2.97 |
| | --- | 87891-3302 | --- | 33 | --- | 2 | 83.82 | 81.28 | 11.30 | 5.84 | 2.97 |
| | --- | 87891-3303 | --- | 33 | --- | 3 | 83.82 | 81.28 | 11.30 | 5.84 | 2.97 |
| | --- | 87891-3304 | --- | 33 | --- | 4 | 83.82 | 81.28 | 11.30 | 5.84 | 2.97 |
| | --- | 87891-3305 | --- | 33 | --- | 5 | 83.82 | 81.28 | 11.30 | 5.84 | 2.97 |
| | --- | 87891-3306 | --- | 33 | --- | 6 | 83.82 | 81.28 | 11.30 | 5.84 | 2.97 |
| | | | | | | | | | | | |
| | | | | | | | | | | | |

| | PACKAGING OPTION PART NO. | | | CKT SIZE | VOID POSITION | PLATING TYPE | DIMENSION | | | | |
|---|---------------------------|------------|------------------|----------|---------------|--------------|-----------|-------|-------|------|------|
| | TRAY | BULK | TUBE WITHOUT CAP | | | | A | B | F | M | P |
| F | --- | 87891-3401 | --- | 34 | --- | 1 | 86.36 | 83.82 | 11.30 | 5.84 | 2.97 |
| | --- | 87891-3402 | --- | 34 | --- | 2 | 86.36 | 83.82 | 11.30 | 5.84 | 2.97 |
| | --- | 87891-3403 | --- | 34 | --- | 3 | 86.36 | 83.82 | 11.30 | 5.84 | 2.97 |
| | --- | 87891-3404 | --- | 34 | --- | 4 | 86.36 | 83.82 | 11.30 | 5.84 | 2.97 |
| | --- | 87891-3405 | --- | 34 | --- | 5 | 86.36 | 83.82 | 11.30 | 5.84 | 2.97 |
| | --- | 87891-3406 | --- | 34 | --- | 6 | 86.36 | 83.82 | 11.30 | 5.84 | 2.97 |
| | | | | | | | | | | | |
| | | | | | | | | | | | |
| E | --- | 87891-3501 | --- | 35 | --- | 1 | 88.90 | 86.36 | 11.30 | 5.84 | 2.97 |
| | --- | 87891-3502 | --- | 35 | --- | 2 | 88.90 | 86.36 | 11.30 | 5.84 | 2.97 |
| | --- | 87891-3503 | --- | 35 | --- | 3 | 88.90 | 86.36 | 11.30 | 5.84 | 2.97 |
| | --- | 87891-3504 | --- | 35 | --- | 4 | 88.90 | 86.36 | 11.30 | 5.84 | 2.97 |
| | --- | 87891-3505 | --- | 35 | --- | 5 | 88.90 | 86.36 | 11.30 | 5.84 | 2.97 |
| | --- | 87891-3506 | --- | 35 | --- | 6 | 88.90 | 86.36 | 11.30 | 5.84 | 2.97 |
| | | | | | | | | | | | |
| | | | | | | | | | | | |
| D | --- | 87891-3611 | --- | 36 | --- | 1 | 91.44 | 88.90 | 11.30 | 5.84 | 2.97 |
| | --- | 87891-3602 | --- | 36 | --- | 2 | 91.44 | 88.90 | 11.30 | 5.84 | 2.97 |
| | --- | 87891-3603 | --- | 36 | --- | 3 | 91.44 | 88.90 | 11.30 | 5.84 | 2.97 |
| | --- | 87891-3604 | --- | 36 | --- | 4 | 91.44 | 88.90 | 11.30 | 5.84 | 2.97 |
| | --- | 87891-3605 | --- | 36 | --- | 5 | 91.44 | 88.90 | 11.30 | 5.84 | 2.97 |
| | --- | 87891-3606 | --- | 36 | --- | 6 | 91.44 | 88.90 | 11.30 | 5.84 | 2.97 |
| | | | | | | | | | | | |
| | | | | | | | | | | | |

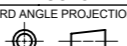
| | | | | | | | | | | | | | |
|---|--|-------|--|---|--|---------|--|---|--|----------------|--|--------------|--|
| THIS DRAWING CONTAINS INFORMATION THAT IS PROPRIETARY TO MOLEX ELECTRONIC TECHNOLOGIES, LLC AND SHOULD NOT BE USED WITHOUT WRITTEN PERMISSION | | | | | | | | | | | | | |
| DIMENSION UNITS | | SCALE | | CURRENT REV DESC: | | | |  | | | | | |
| mm | | NTS | | | | | | | | | | | |
| GENERAL TOLERANCES (UNLESS SPECIFIED) | | | | EC NO: 679909 DRWN: AKUMAR19 2021/10/08 CHK'D: MRAMAKRISHNA 2021/10/11 APPR: MRAMAKRISHNA 2021/10/11 | | | | CUSTOM HEADER 2.54MM PITCH, SINGLE ROW SINGLE WAFER, T/H HEADER | | | | | |
| ANGULAR TOL ± 3.0 ° | | | | | | | | | | | | | |
| 4 PLACES ± | | | | | | | | PRODUCT CUSTOMER DRAWING | | | | | |
| 3 PLACES ± | | | | | | | | | | | | | |
| 2 PLACES ± 0.2 | | | | | | | | | | | | | |
| 1 PLACE ± | | | | DOCUMENT NUMBER SD-87891-013 | | | | DOC TYPE | | DOC PART | | REVISION | |
| 0 PLACES ± | | | | | | | | PSD | | 001 | | B5 | |
| INITIAL REVISION: | | | | DRWN: YLQIAO 2004/12/06 APPR: SLOW 2004/12/07 | | | | MATERIAL NUMBER | | CUSTOMER | | SHEET NUMBER | |
| DRAFT WHERE APPLICABLE MUST REMAIN WITHIN DIMENSIONS | | | | THIRD ANGLE PROJECTION | | DRAWING | | SERIES | | GENERAL MARKET | | 7 OF 8 | |
| | | | |  | | A3-SIZE | | 87891 | | | | | |

