

**PLEASE CHECK WWW.MOLEX.COM FOR LATEST PART INFORMATION**

**Part Number:** [0011402274](#)  
**Status:** **Active**  
**Overview:** [Application Tooling](#)  
**Description:** Terminator Die

**Documents:**

[RoHS Certificate of Compliance \(PDF\)](#)

**General**

Product Family	Application Tooling
Series	<a href="#">207122</a>
Function	Crimp
Geographic Area	Global
Level of Automation	Semi-Automatic
More Detailed Tech Information	<a href="mailto:applicationtooling@molex.com">applicationtooling@molex.com</a>
Overview	<a href="#">Application Tooling</a>
Product Name	N/A
Taxonomy	Applicators and Crimp Modules
Tool Type	Terminator Die
UPC	800753746466
Warranty Disclaimer	CAUTION: Molex tooling crimp specifications are valid only when used with Molex terminals and tooling manufactured by Molex and sold by Molex or authorized distributors ("Molex Tooling"). When using tooling other than Molex Tooling with Molex specific connector systems listed in our ATS documents, the Molex tooling qualification does not apply and the responsibility for full qualification of the connector system is that of the customer. Molex accepts no liability for connector performance or tooling support where tooling other than Molex Tooling is used or where Molex Tooling is modified.

**Material Info**

Engineering Number T63309A

**Reference - Drawing Numbers**

Application Tooling Documents  
T63309A-001, TM-638000029-001,  
TM-638000029CN-001, TM-638000029DE-001,  
TM-638000029FR-001, TM-638000029IT-001,  
TM-638000029JP-001, TM-638000029KR-001,  
TM-638000029MY-001, TM-638000029PL-001,  
TM-638000029RU-001, TM-638000029SK-001,  
TM-638000029SP-001, TM-638000029TH-001,  
TM-638000029TW-001, TM-638000029VN-001,  
TM-638500090-001, TM-638500090SP-001

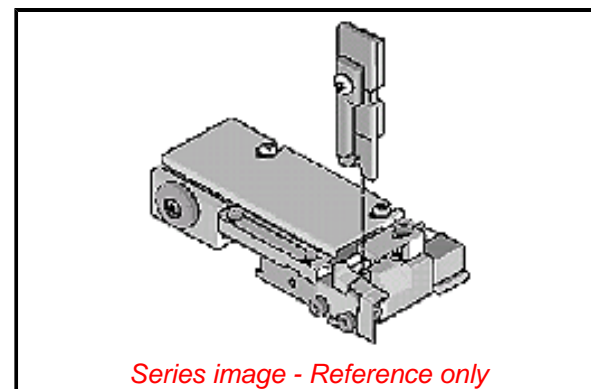

**EU ELV**

**Not Reviewed**

**EU RoHS**

**Not Reviewed**

**REACH SVHC**

Not Reviewed

**Halogen-Free**

**Status**

**Not Reviewed**

For more information, please visit [Contact US](#)

China ROHS

Not Reviewed

ELV

Not Reviewed

RoHS Phthalates

Not Reviewed

**Search Parts in this Series**

[207122 Series](#)

**Use With**

Molex TM-42 Press [690025001](#) and Base Unit [11193001](#) for the 3BF Press