

DO NOT SCALE FROM THIS PRINT

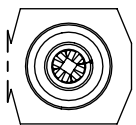

DETAIL 'A'  
SCALE 6 : 1  
(SEE TABLE 1 & NOTE 7)

SX-1XX-XX-XX-X-X

**BODY SPECIFICATION**  
 SS: SINGLE (USE SSB-XX, SEE FIG 1)  
 (NOT AVAILABLE FOR LEAD STYLES -10,  
 -11, -12, -19, -30, -31, -32, & -39)  
 (SEE NOTE 5)  
 SL: SINGLE SLIM (USE SSL-XX, SEE FIG 5)  
 (ONLY AVAILABLE FOR LEAD STYLES -10,  
 -11, -12, -19, -30, -31, -32, & -39)

**OPTION**  
 -N: NON-FLUSH  
 (SEE NOTE 6)  
 (NOT AVAILABLE ON LEAD STYLES  
 -5A, -7, -21A, -21B, -21C, -23, -28, & -29)

**OPTION**  
 -L: LOCKING LEAD  
 (ONLY AVAILABLE WITH LEAD STYLES -2 & -22)  
 (ONLY AVAILABLE WITH -T PLATING)

**LEAD STYLE**  
 (SEE SOCKET SPECIFICATION, TABLES 1 & 2)

**PLATING SPECIFICATION**  
 -G: 30µ" GOLD ON CONTACT,  
 10µ" GOLD ON SHELL  
 (-5 & -5A LEAD STYLES NOT AVAILABLE,  
 -28 AND -7 AVAILABLE TO EXISTING CUSTOMERS ONLY)  
 -T: 30µ" GOLD ON CONTACT,  
 MATTE TIN ON SHELL  
 (-3 & -7 LEAD STYLES NOT AVAILABLE,  
 -28 AVAILABLE TO EXISTING CUSTOMERS ONLY)  
 -TT: MATTE TIN ON CONTACT, MATTE TIN ON SHELL  
 (NOT AVAILABLE ON LEAD STYLES -3, -5, -5A, -7 & -21A THRU -39)  
 -S: 10µ" SELECTIVE GOLD ON CONTACT,  
 MATTE TIN ON SHELL  
 (ONLY AVAILABLE ON LEAD STYLES -2 & -22)  
 (FOR LOCKING LEAD OPTION, USE SC-1L1-GT)  
 (NOT AVAILABLE ON SL)

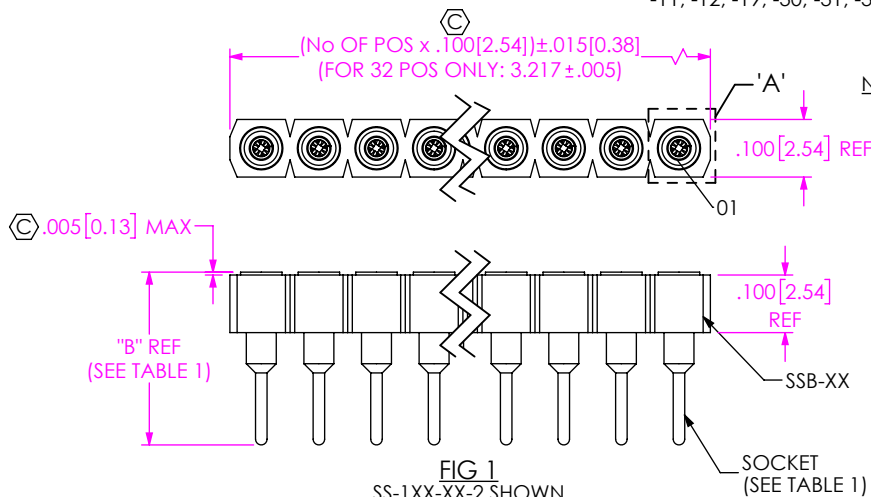

No OF POSITIONS  
 -01 THRU -32  
 (PER ROW)

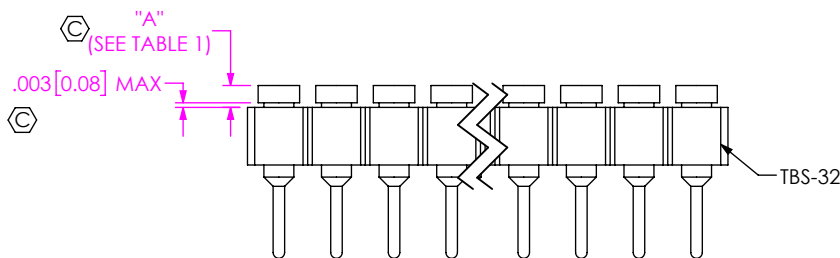

FIG 2  
 SS-1XX-XX-2-N SHOWN  
 (SEE NOTE 6)  
 (SAME AS FIG 1, DIFFERENT AS SHOWN)

LEAD STYLE	SOCKET	"A" (-N OPTION ONLY)		"B" (PIN LENGTH)	No OF FINGER CLIPS (SEE NOTE 7)
		MIN	MAX		
-1A	SC-1W1-XX-2	N/A	.038 [0.97]	.553 [14.05]	4
-1B	SC-1W1-XX-1	N/A	.038 [0.97]	.703 [17.86]	4
-1C	SC-1W1-XX-3	N/A	.038 [0.97]	.453 [11.51]	4
-2	SC-1P1-XX	.025 [0.64]	.038 [0.97]	.300 [7.62]	4
-3	SC-1S1-XX	N/A	.038 [0.97]	.203 [5.16]	4
*-5	SC-2P1-XX	N/A	.038 [0.97]	.703 [17.86]	4
*-5A	SC-2P1-XX	N/A	N/A	.703 [17.86]	4
*-7	SC-1P3-XX	N/A	N/A	.600 [15.24]	4
*-13	SC-2P7-XX	N/A	.039 [0.99]	.310 [7.87]	4
-18	SC-6P1-XX	.025 [0.64]	.038 [0.97]	.353 [8.97]	4
-21A	EZ-1W1-XX-2	N/A	N/A	.553 [14.05]	6
-21B	EZ-1W1-XX-1	N/A	N/A	.703 [17.86]	6
-21C	EZ-1W1-XX-3	N/A	N/A	.453 [11.51]	6
-22	EZ-1P1-XX	.025 [0.64]	.038 [0.97]	.300 [7.62]	6
-28	EZ-2P3-XX	N/A	N/A	.542 [13.77]	6
-29	EZ-2P2-XX	N/A	N/A	.703 [17.86]	6
-38	EZ-6P1-XX	.025 [0.64]	.038 [0.97]	.353 [8.97]	6

\* AVAILABLE TO EXISTING CUSTOMERS ONLY.

NOTES:

- ⊕ REPRESENTS A CRITICAL DIMENSION.
- MAXIMUM CUT FLASH: .005[0.13] IN ALL AREAS EXCEPT BAR BREAK OFF AREA; .012[0.31] IN BAR BREAK OFF AREA
- MINIMUM PUSHOUT FORCE: 2 LBS.
- MAXIMUM ALLOWABLE BOW: SS: 2-10 POS: .004[0.10], 11-32 POS: .005[0.13] IN/IN; SL: 2-10 POS: .006[0.15], 11-19 POS: .015[0.38] IN/IN, 20-32 POS: .025[0.64] IN/IN.
- FOR SS-STYLE -13, USE SSB-32-B.
- FOR ALL -SS WITH -N OPTION, AND FOR -5 LEAD STYLE, USE TBS-32 AND INSERT PIN ON THE COUNTERBORED SIDE.
- OPERATOR MUST VERIFY CORRECT PIN BY CHECKING THE NUMBER OF CLIPS.
- POSITIONS 1 - 4 AND ANY BODY/LEAD STYLES NOT LISTED IN THE TUBE TABLE TO BE PACKAGED IN BULK.

UNLESS OTHERWISE SPECIFIED, DIMENSIONS ARE IN INCHES. TOLERANCES ARE:  
 DECIMALS ANGLES  
 .XX: ±.01 [0.3] 2°  
 .XXX: ±.005 [0.13]  
 .XXXX: ±.0020 [0.051]

**PROPRIETARY NOTE**  
 THIS DOCUMENT CONTAINS CONFIDENTIAL AND PROPRIETARY INFORMATION AND ALL DESIGN, MANUFACTURING, REPRODUCTION, USE, PATENT RIGHTS AND SALES RIGHTS ARE EXPRESSLY RESERVED BY SAMTEC, INC. THIS DOCUMENT SHALL NOT BE DISCLOSED, IN WHOLE OR PART, TO ANY UNAUTHORIZED PERSON OR ENTITY NOR REPRODUCED, TRANSFERRED OR INCORPORATED IN ANY OTHER PROJECT IN ANY MANNER WITHOUT THE EXPRESS WRITTEN CONSENT OF SAMTEC, INC.



520 PARK EAST BLVD, NEW ALBANY, IN 47150  
 PHONE: 812-944-6733 FAX: 812-948-5047  
 e-Mail info@SAMTEC.com code 55322

**MATERIAL:** DO NOT SCALE DRAWING SHEET SCALE: 3:1  
 INSULATOR: SS PBT, COLOR: BLACK  
 SL: LCP, COLOR: BLACK  
 SOCKET: BeCu/BRASS  
 BRASS  
 F:\DWG\MISC\MKTG\SX-1XX-XX-XX-X-X-MKT.SLDDRW

**DESCRIPTION:** SOCKET STRIP ASSEMBLY  
**DWG. NO.** SX-1XX-XX-XX-X-X  
**BY:** J. BROWNING 08/06/2015 **SHEET 1 OF 2**

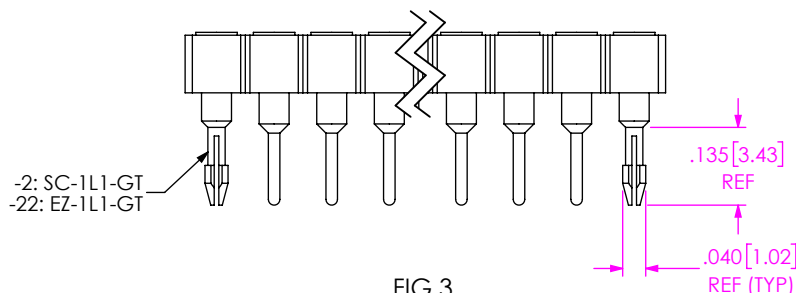

**FIG 3**  
SS-1XX-XX-22-L SHOWN  
(ONLY AVAILABLE IN LEAD STYLES -2 & -22)  
(SAME AS FIG 1, DIFFERENT AS SHOWN)

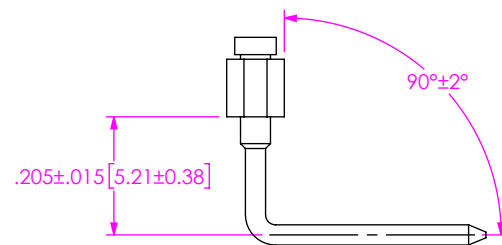

**FIG 4**  
SS-1XX-XX-5 SHOWN  
(SAME AS FIG 2, DIFFERENT AS SHOWN)

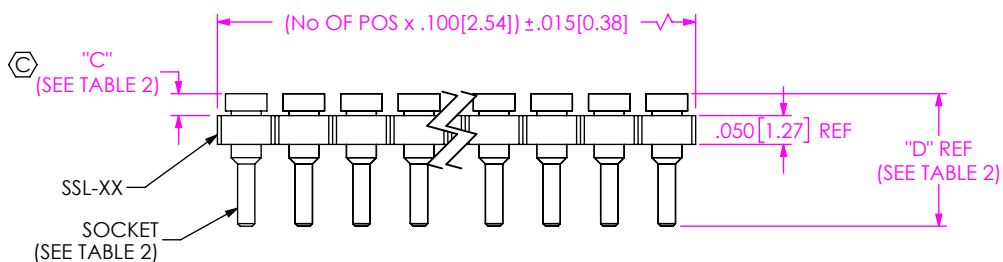

**FIG 5**  
SL-1XX-XX-10 SHOWN  
(SAME AS FIG 1, EXCEPT AS SHOWN)

**TABLE 2 - SL LEAD STYLES**

LEAD STYLE	SOCKET	"C"		"D" (PIN LENGTH)	No OF FINGER CLIPS (SEE NOTE 7)
		MIN	MAX		
-10	SC-3P1-XX	.025 [0.64]	.038 [0.97]	.230 [5.84]	4
-11	SC-4P1-XX	.015 [0.38]	.028 [0.71]	.240 [6.10]	4
-12	SC-5P1-XX	.015 [0.38]	.028 [0.71]	.190 [4.83]	4
-19	SC-8P1-XX	.005 [0.13]	.016 [0.41]	.165 [4.19]	4
-30	EZ-3P1-XX	.025 [0.64]	.038 [0.97]	.230 [5.84]	6
-31	EZ-4P1-XX	.015 [0.38]	.028 [0.71]	.240 [6.10]	6
-32	EZ-5P1-XX	.015 [0.38]	.028 [0.71]	.190 [4.83]	6
-39	EZ-8P1-XX	.005 [0.13]	.016 [0.41]	.165 [4.19]	6

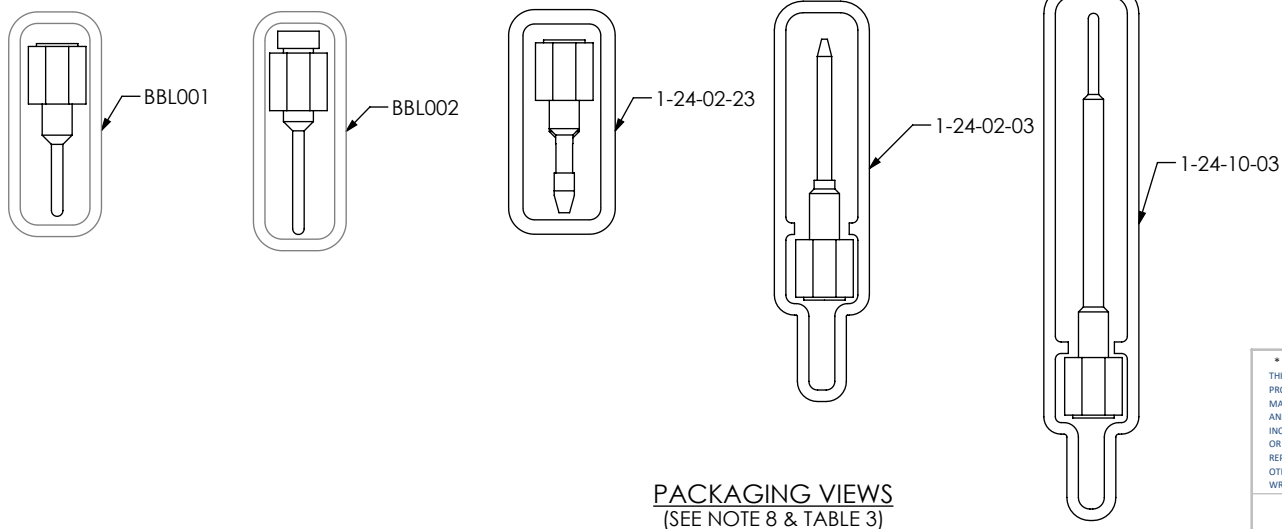

**PACKAGING VIEWS**  
(SEE NOTE 8 & TABLE 3)

**TABLE 3 - PACKAGING TUBES**

BODY STYLE	LEAD STYLE	TUBE	PLUG
-SS	-2, -3, -13, -22, -23	PT-BBL001	TP-12
	-18, -38	PT-BBL002	TP-12
	-2-L, -22-L	PT-1-24-02-23	TP-12
	-1C, -21C	PT-1-24-02-03	TP-24
	-29	PT-1-24-10-03	TP-03

**PROPRIETARY NOTE**  
THIS DOCUMENT CONTAINS CONFIDENTIAL AND PROPRIETARY INFORMATION AND ALL DESIGN, MANUFACTURING, REPRODUCTION, USE, PATENT RIGHTS AND SALES RIGHTS ARE EXPRESSLY RESERVED BY SAMTEC, INC. THIS DOCUMENT SHALL NOT BE DISCLOSED, IN WHOLE OR PART, TO ANY UNAUTHORIZED PERSON OR ENTITY NOR REPRODUCED, TRANSFERRED OR INCORPORATED IN ANY OTHER PROJECT IN ANY MANNER WITHOUT THE EXPRESS WRITTEN CONSENT OF SAMTEC, INC.



520 PARK EAST BLVD, NEW ALBANY, IN 47150  
PHONE: 812-944-6733 FAX: 812-948-5047  
e-Mail: info@SAMTEC.com code 55322

DO NOT SCALE DRAWING

SHEET SCALE: 3:1

DESCRIPTION: SOCKET STRIP ASSEMBLY

DWG. NO. **SX-1XX-XX-XX-X-X**

BY: J. BROWNING 08/06/2015 SHEET 2 OF 2