

ARM<sup>®</sup> Cortex<sup>®</sup>-M  
32-bit Microcontroller

NuMicro<sup>®</sup> Family  
NuTiny-SDK-NUC029SDE  
User Manual

*The information described in this document is the exclusive intellectual property of Nuvoton Technology Corporation and shall not be reproduced without permission from Nuvoton.*

*Nuvoton is providing this document only for reference purposes of NuMicro<sup>®</sup> microcontroller based system design. Nuvoton assumes no responsibility for errors or omissions.*

*All data and specifications are subject to change without notice.*

For additional information or questions, please contact: Nuvoton Technology Corporation.

[www.nuvoton.com](http://www.nuvoton.com)

**Table of Contents**

1 OVERVIEW ..... 4

2 NUTINY-SDK-NUC029SDE INTRODUCTION ..... 5

    2.1 NuTiny-SDK-NUC029SDE Jumper Description ..... 6

        2.1.1 Power Setting ..... 6

        2.1.2 Debug Connector ..... 6

        2.1.3 USB Connector ..... 6

        2.1.4 Extended Connector ..... 6

        2.1.5 Reset Button ..... 6

        2.1.6 Power Connector ..... 6

        2.1.7 VCOM Enable ..... 6

    2.2 Pin Assignment for Extended Connector ..... 8

    2.3 NuTiny-SDK-NUC029SDE PCB Placement ..... 11

3 How to Start NuTiny-SDK-NUC029SDE on the Keil mdk ENVIRONMENT ..... 12

    3.1 Downloading and Installing Keil MDK Software ..... 12

    3.2 Downloading and Installing Nuvoton Nu-Link Driver ..... 12

    3.3 Hardware Setup ..... 12

    3.4 Example Program ..... 12

4 How to Start NuTiny-SDK-NUC029SDE on the IAR Embedded Workbench ..... 14

    4.1 Downloading and Installing IAR Embedded Workbench Software ..... 14

    4.2 Downloading and Installing Nuvoton Nu-Link Driver ..... 14

    4.3 Hardware Setup ..... 14

    4.4 Example Program ..... 14

5 Starting to Use Nu-Link-Me 3.0 VCOM Function ..... 16

    5.1 Downloading and Installing VCOM Driver ..... 16

    5.2 VCOM Mode Setting on NuTiny-SDK-NUC029SDE ..... 18

    5.3 Development Tool Setup ..... 18

        5.3.1 Check the Using UART on the Keil  $\mu$ Vision<sup>®</sup> IDE ..... 18

        5.3.2 Check the Target Device and Debug Setting ..... 19

        5.3.3 Build and Download Code to NuTiny-SDK-NUC029SDE ..... 21

        5.3.4 Open the Serial Port Terminal ..... 21

        5.3.5 Reset Chip ..... 22

6 NuTiny-SDK-NUC029SDE Schematics ..... 23

    6.1 Nu-Link-Me V3.0 Schematic ..... 23

6.2 GPIO for 64 pin Schematic .....24

6.3 SDK Circuit Schematic.....25

6.4 Target Chip .....26

7 REVISION HISTORY ..... 27

## 1 OVERVIEW

NuTiny-SDK-NUC029SDE is a specific development tool for NuMicro<sup>®</sup> NUC029SDE. With the NuTiny-SDK-NUC029SDE, user can develop and verify the application program easily.

The NuTiny-SDK-NUC029SDE includes two portions. One is NuTiny-EVB-NUC029SDE and the other is Nu-Link-Me. NuTiny-EVB-NUC029SDE is the evaluation board and Nu-Link-Me is its Debug Adaptor. Thus, user does not need other additional ICE or debug equipment.

The NUC029SDE can bridge the gap and replace the cost equivalent to traditional 8- and 16-bit microcontroller by 32-bit performance and rich functions. The NUC029SDE supports a wide range of applications from low-end, price sensitive designs to computing-intensive ones and provides advanced high-end features in economical products.

The NUC029SDE of NUC029 series is embedded with the Cortex<sup>®</sup>-M0 core and offers 68 Kbytes Flash, 4 Kbytes Flash for the ISP, and 8 Kbytes SRAM for industrial control and applications which need rich communication interfaces or require high performance, high integration.

The NUC029SDE can run up to 50MHz and operate at standard industrial voltage 2.5V ~ 5.5V with -40°C ~ 105°C. It is also equipped with plenty of peripheral devices, such as Timers, Watchdog Timer (WDT), Window Watchdog Timer (WWDT), UART, SPI, I<sup>2</sup>C, PWM, GPIO, LIN, 1000 kSPS high speed 12-bit ADC, Low Voltage Reset Controller and Brown-out Detector.

Additionally, the NUC029SDE is equipped with ISP (In-System Programming) and ICP (In-Circuit Programming) functions, which allow the user to update the program memory without removing the chip from the actual end product. The NUC029SDE also supports In-Application-Programming (IAP) function, user switches the code executing without the chip reset after the embedded flash updated.

## 2 NUTINY-SDK-NUC029SDE INTRODUCTION

The NuTiny-SDK-NUC029SDE uses the NUC029SDE as the target microcontroller. Figure 2-1 is NuTiny-SDK-NUC029SDE for the NUC029SDE, the left portion is called NuTiny-EVB-NUC029SDE and the right portion is Debug Adaptor called Nu-Link-Me.

The NuTiny-EVB-NUC029SDE is similar to other development boards. Users can use it to develop and verify applications to emulate the real behavior. The on board chip covers NUC029SDE features. The NuTiny-EVB-NUC029SDE can be a real system controller to design user's target systems.

Nu-Link-Me is a Debug Adaptor. The Nu-Link-Me Debug Adaptor connects your PC's USB port to your target system (via Serial Wired Debug Port) and allows you to program and debug embedded programs on the target hardware. The Nu-Link-Me V3.0 also supports VCOM function, which gives users more flexibility when debugging. To use the Nu-Link-Me Debug adaptor with IAR or Keil, please refer to "Nuvoton NuMicro® IAR ICE driver user manual" or Nuvoton NuMicro® Keil ICE driver user manual" in detail. These two documents will be stored in the local hard disk when the user installs each driver. To use Nu-Link-Me 3.0 VCOM function, please refer to Chapter 5.

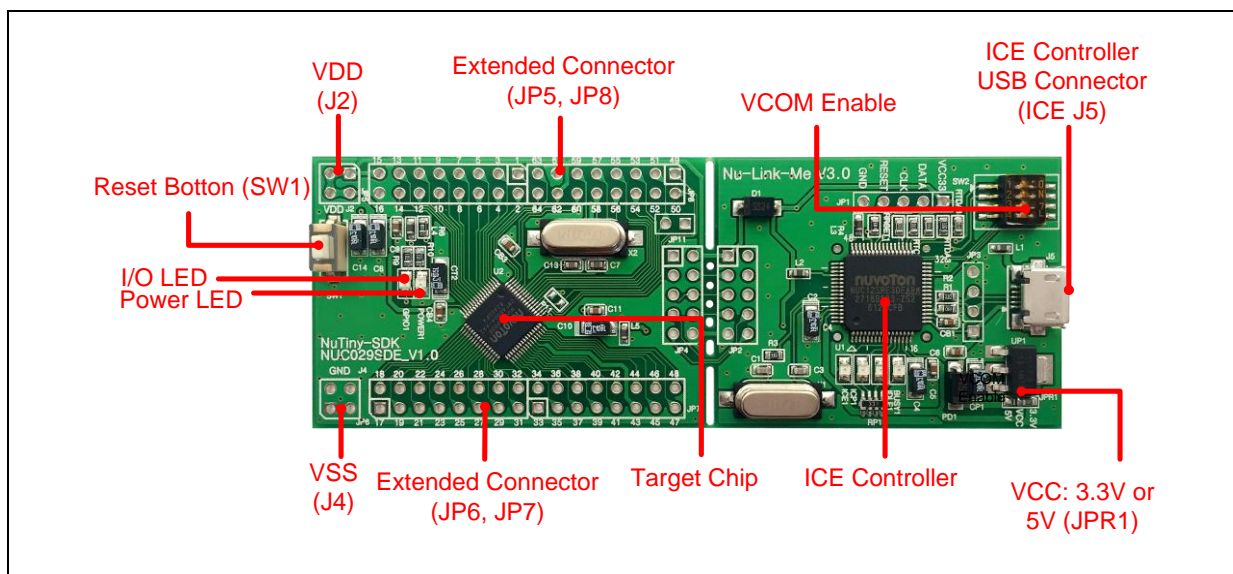

Figure 2-1 NuTiny-SDK-NUC029SDE (PCB Board)

## 2.1 NuTiny-SDK-NUC029SDE Jumper Description

### 2.1.1 Power Setting

- J5: USB port in Nu-Link-Me
- J2:  $V_{DD}$  Voltage connector in NuTiny-EVB-NUC029SDE

Model	JPR1	J5 USB port	J2 $V_{DD}$	MCU Voltage
Model 1	Select VCC33 (default)	Connect to PC	DC 3.3V output	DC 3.3V
Model 2	X	X	DC 2.5 V ~ 5.5 V Input	Voltage by J2 input

X: Unused.

### 2.1.2 Debug Connector

- **JP4:** Connector in target board (NuTiny-EVB-NUC029SDE) for connecting with Nuvoton ICE adaptor (Nu-Link-Me V3.0)
- **JP2:** Connector in ICE adaptor (Nu-Link-Me V3.0) for connecting with a target board (for example NuTiny-EVB-NUC029SDE)

### 2.1.3 USB Connector

- **J5:** Micro USB Connector in Nu-Link-Me V3.0 connected to a PC USB port

### 2.1.4 Extended Connector

- **JP5, JP6, JP7, JP8:** Show all chip pins in NuTiny-EVB-NUC029SDE

### 2.1.5 Reset Button

- **SW1:** Reset button in NuTiny-EVB-NUC029SDE

### 2.1.6 Power Connector

- **J2:**  $V_{DD}$  connector in NuTiny-EVB-NUC029SDE
- **J4:**  $V_{SS}$  connector in NuTiny-EVB-NUC029SDE

### 2.1.7 VCOM Enable

- **SW2:** VCOM function enable for the NuTiny-SDK-NUC029SDE. Switch SW2 on before power on to enable VCOM function. SW2 connects pin 17(PB.0/RXD) and pin 18(PB.1/TXD) in NuTiny-EVB-NUC029SDE with pin 22(PB.1/TXD) and pin 21(PB.0/RXD) in Nuvoton ICE adaptor (Nu-Link-Me V3.0). SW2 connects pin 29(VCOM) in Nuvoton ICE adaptor (Nu-Link-Me V3.0) to GND to enable VCOM function.

Switch Pin Number	Function Name	UART0 Mode	VCOM Mode
1	ICE_TX	Off	On
2	ICE_RX	Off	On
3	VCOM_EN	Off	On
4	X	X	X

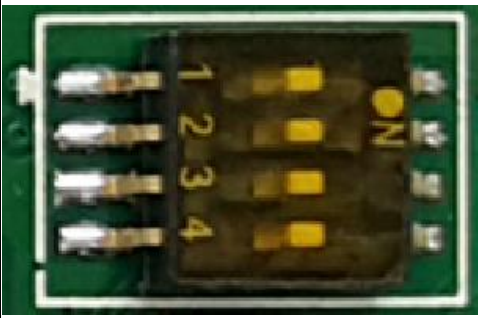

X: Unused.

## 2.2 Pin Assignment for Extended Connector

The NuTiny-EVB-NUC029SDE provides NUC029SDE on board and the extended connector (JP5, JP6, JP7 and JP8) for LQFP-64 pin. Table 2-1 is the pin assignment for NUC029SDE.

Pin No	Pin Function
1	INT0/PB.14
2	PB.13
3	CLKO/PB.12
4	PWM1_CH5/I2C0_SCL/PF.5
5	PWM1_CH4/I2C0_SDA/PF.4
6	PWM1_CH3/I2C1_SCL/PA.11
7	PWM1_CH2/I2C1_SDA/PA.10
8	UART1_nCTS/I2C0_SCL/PA.9
9	UART1_nRTS/I2C0_SDA/PA.8
10	UART1_RXD/PB.4
11	UART1_TXD/PB.5
12	UART1_nRTS/PB.6
13	UART1_nCTS/PB.7
14	LDO_CAP
15	V <sub>DD</sub>
16	V <sub>SS</sub>
17	PB.0/UART0_RXD
18	PB.1/UART0_TXD
19	PB.2/UART0_nRTS/TM2_EXT/TM2/PWM1_BRAKE1
20	PB.3/UART0_nCTS/TM3_EXT/TM3/PWM1_BRAKE0
21	PD.6
22	PD.7
23	PD.14/UART2_RXD
24	PD.15/UART2_TXD
25	PC.3/SPI0_MOSI0
26	PC.2/SPI0_MISO0
27	PC.1/SPI0_CLK
28	V <sub>SS</sub>
29	PE.5/TM1_EXT/TM1/PWM0_CH5



30	PB.11/TM3/PWM0_CH4
31	PB.10/TM2
32	PB.9/TM1
33	PC.11/PWM1_BRAKE1
34	PC.10/PWM1_BRAKE0
35	PC.9/PWM0_BRAKE1
36	PC.8/PWM0_BRAKE0
37	PA.15/PWM0_CH3
38	PA.14/PWM0_CH2
39	PA.13/PWM0_CH1
40	PA.12/PWM0_CH0
41	PF.7/ICE_DAT
42	PF.6/ICE_CLK
43	AV <sub>SS</sub>
44	PA.0/ADC_CH0/PWM0_CH4/I2C1_SCL
45	PA.1/ADC_CH1/PWM0_CH5/I2C1_SDA
46	PA.2/ADC_CH2/PWM1_CH0/UART3_TXD
47	PA.3/ADC_CH3/PWM1_CH1/UART3_RXD
48	PA.4/ADC_CH4
49	UART3_RXD/ADC_CH5/PA.5
50	UART3_TXD/ADC_CH6/PA.6
51	V <sub>REF</sub> /ADC_CH7/PA.7
52	AV <sub>DD</sub>
53	PWM0_BRAKE1/I2C0_SCL/PC.7
54	PWM0_BRAKE0/I2C0_SDA/PC.6
55	PC.15
56	PC.14
57	TM0/TM0_EXT/INT1/PB.15
58	XT1_OUT/PF.0
59	XT1_IN/PF.1
60	nRESET
61	V <sub>SS</sub>

62	V <sub>DD</sub>
63	CLKO/PF.8
64	CLKO/TM0/STADC/PB.8

Table 2-1 Pin Assignment for NUC029SDE

### 2.3 NuTiny-SDK-NUC029SDE PCB Placement

Figure 2-2 shows the NuTiny-SDK-NUC029SDE PCB placement.

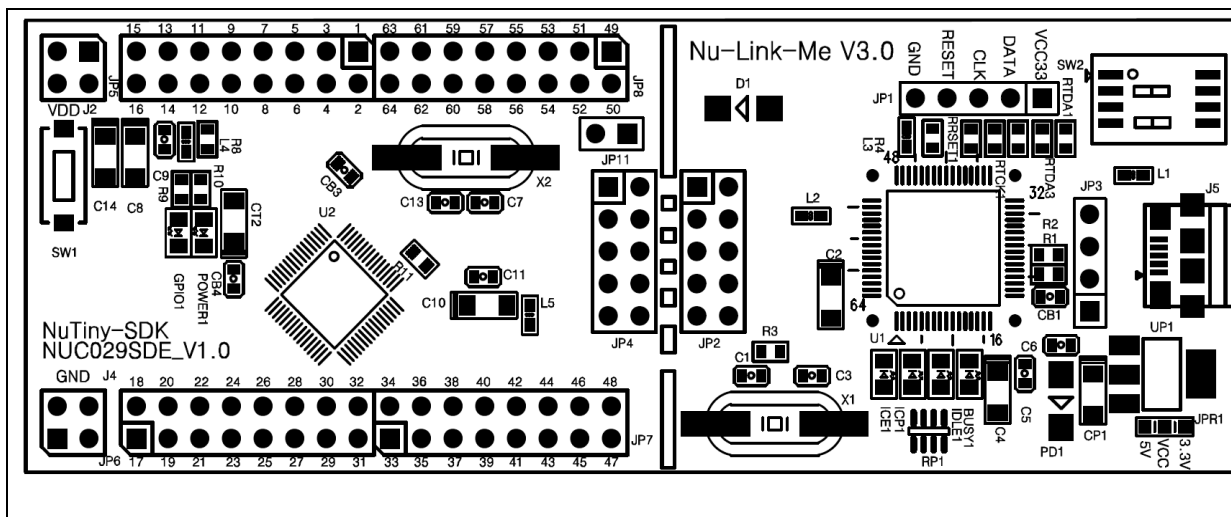

Figure 2-2 NuTiny-SDK-NUC029SDE PCB Placement

### 3 HOW TO START NUTINY-SDK-NUC029SDE ON THE KEIL MDK ENVIRONMENT

#### 3.1 Downloading and Installing Keil MDK Software

Please visit the Keil company website (<http://www.keil.com>) to download and install the Keil MDK.

#### 3.2 Downloading and Installing Nuvoton Nu-Link Driver

Please visit the official Nuvoton NuMicro® website (<http://www.nuvoton.com/NuMicro>) to download “NuMicro® Keil μVision® IDE driver” file. When the Nu-Link driver has been well downloaded, please unzip the file and execute the “Nu-Link\_Keil\_Driver.exe” to install the driver.

#### 3.3 Hardware Setup

The hardware setup is shown as Figure 3-1.











Figure 3-1 NuTiny-SDK-NUC029SDE Hardware Setup

#### 3.4 Example Program

This example demonstrates downloading and debugging an application on a NuTiny-SDK-NUC029SDE board. It can be found on the list directory and downloaded from Nuvoton NuMicro® website.

<b>Directory</b>	..\NUC029xDEBSPv3.00.001\SampleCode\Template\Keil
------------------	---

This sample code will show some functions about system manager controller and clock controller.

-  Start uVision®
- Project – Open  
Open the SYS.uvproj project file
-  Project – Build  
Compile and link the SYS application
-  Flash – Download  
Program the application code into on-chip Flash ROM
-  Start debug mode  
When using the debugger commands, you may:
  - ◆  Review variables in the watch window
  - ◆  Single step through code
  - ◆  Reset the device
  - ◆  Run the application

## 4 HOW TO START NUTINY-SDK-NUC029SDE ON THE IAR EMBEDDED WORKBENCH

### 4.1 Downloading and Installing IAR Embedded Workbench Software

Please connect to IAR company website (<http://www.iar.com>) to download the IAR Embedded Workbench and install the EWARM.

### 4.2 Downloading and Installing Nuvoton Nu-Link Driver

Please visit the official Nuvoton NuMicro® website (<http://www.nuvoton.com/NuMicro> ) to download the “NuMicro® IAR EWARM Driver” file. When the Nu-Link driver has been well downloaded, please unzip the file and execute the “Nu-Link\_Keil\_Driver.exe” to install the driver.

### 4.3 Hardware Setup

The hardware setup is shown as Figure 4-1.

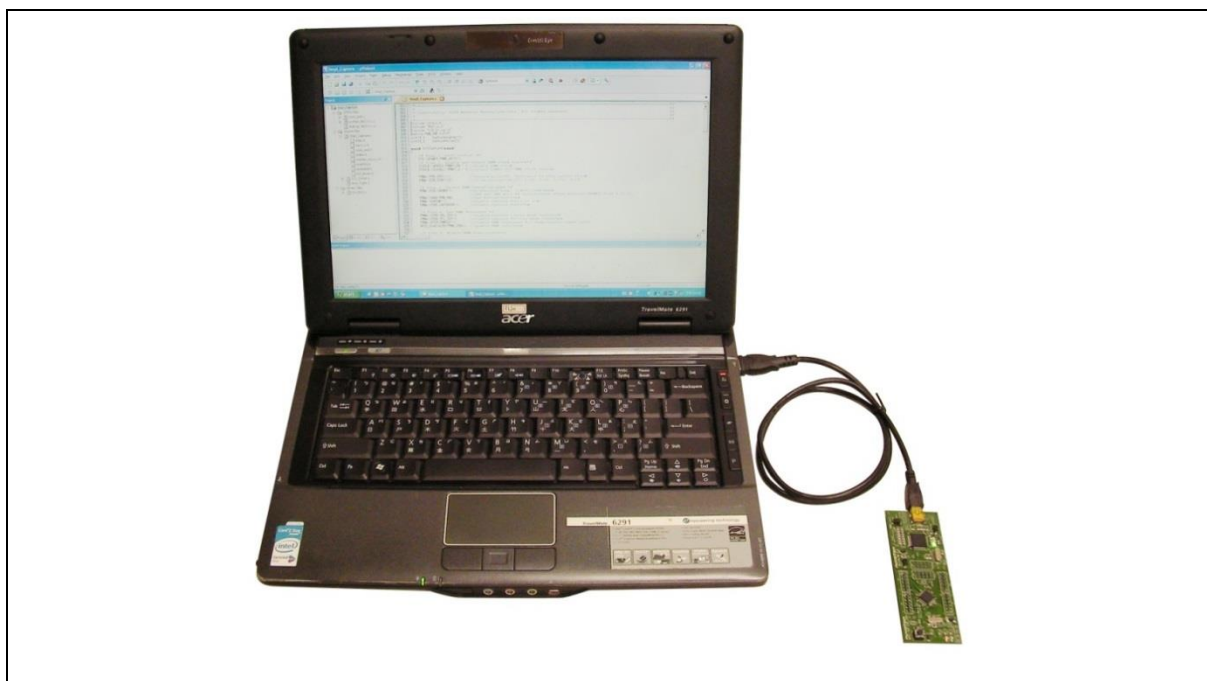







Figure 4-1 NuTiny-SDK-NUC029SDE Hardware Setup

### 4.4 Example Program

This example demonstrates downloading and debugging an application on a NuTiny-SDK-NUC029SDE board. It can be found on the list directory and downloaded from Nuvoton NuMicro® website.

<b>Directory</b>	..\NUC029xDEBSPv3.00.001\SampleCode\Template\IAR
------------------	--

This sample code will show some functions about system manager controller and clock controller.

-  Start IAR Embedded Workbench
-  Project – Download and Debug  
Program the application code into on-chip Flash ROM
- File-Open-Workspace  
Open the SYS.eww workspace file
-  Single step through code
-  Reset the device
-  Project - Make  
Compile and link the SYS application
-  Run the application

## 5 STARTING TO USE NU-LINK-ME 3.0 VCOM FUNCTION

### 5.1 Downloading and Installing VCOM Driver

Please connect to Nuvoton NuMicro® website (<http://www.nuvoton.com/NuMicro>) to download the “NuMicro® ICP Programming Tool” file. After the ICP Programming Tool driver is downloaded, please unzip the file and execute the “ICP Programming Tool.exe”. Simply follow the installation and optional steps to install ICP Programming Tool and Nu-Link USB Driver, which included VCOM driver.

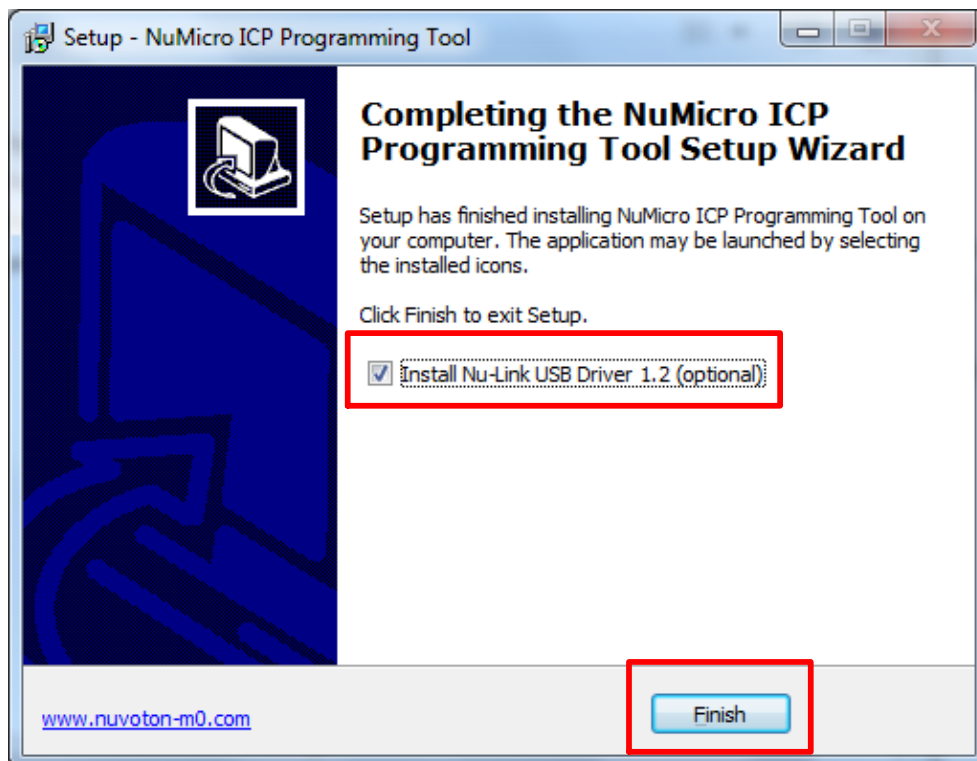

Figure 5-1 Optional Step after ICP Programming Tool Installation

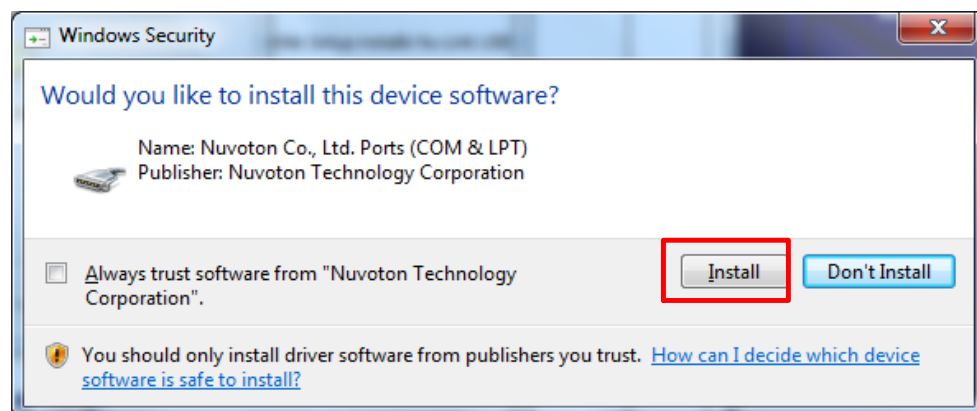

Figure 5-2 Install Nuvoton COM&LPT Driver



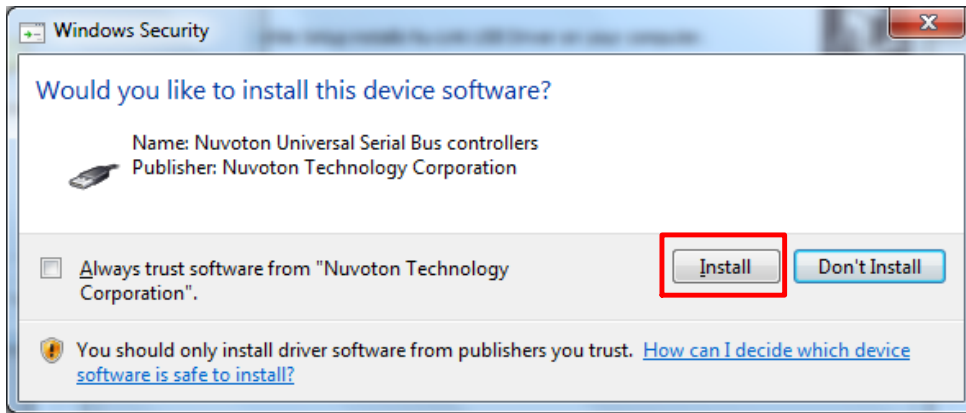

Figure 5-3 Install Nuvoton Universal Serial Bus Controllers

## 5.2 VCOM Mode Setting on NuTiny-SDK-NUC029SDE

Before the NuTiny-SDK-NUC029SDE is connected to the PC, please enable VCOM function by switching on SW2. The NuTiny-EVB-NUC029SDE transmits through UART0 to VCOM to send out data. Switch SW2 off when using UART0 function without VCOM function.

## 5.3 Development Tool Setup

The example is demonstrated on the Keil  $\mu$ Vision<sup>®</sup> IDE.

### 5.3.1 Check the Using UART on the Keil $\mu$ Vision<sup>®</sup> IDE

Please open the project and find system\_NUC029xDE.h to check the using UART in DEBUG\_PORT, which has to be the same as the using UART in the NuTiny-EVB-NUC029SDE.

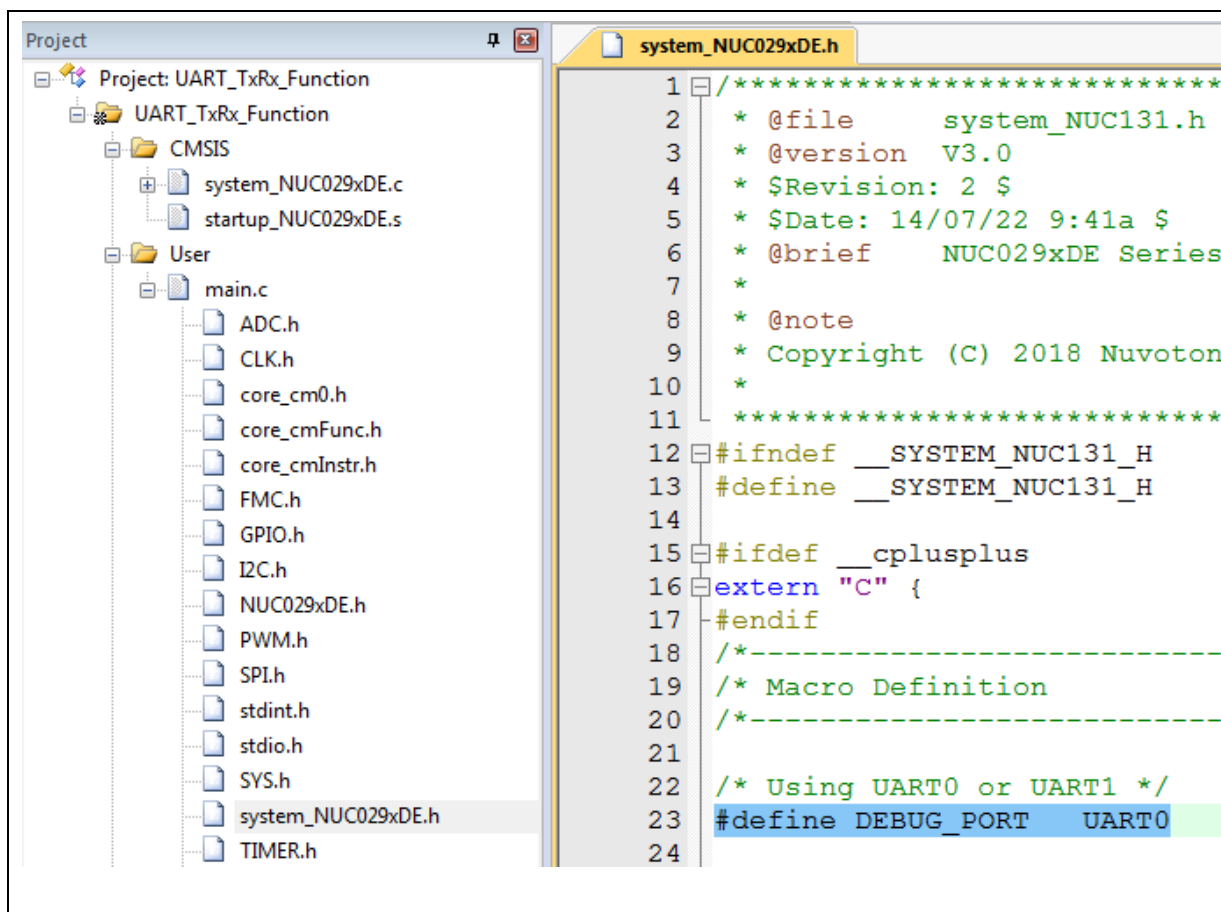
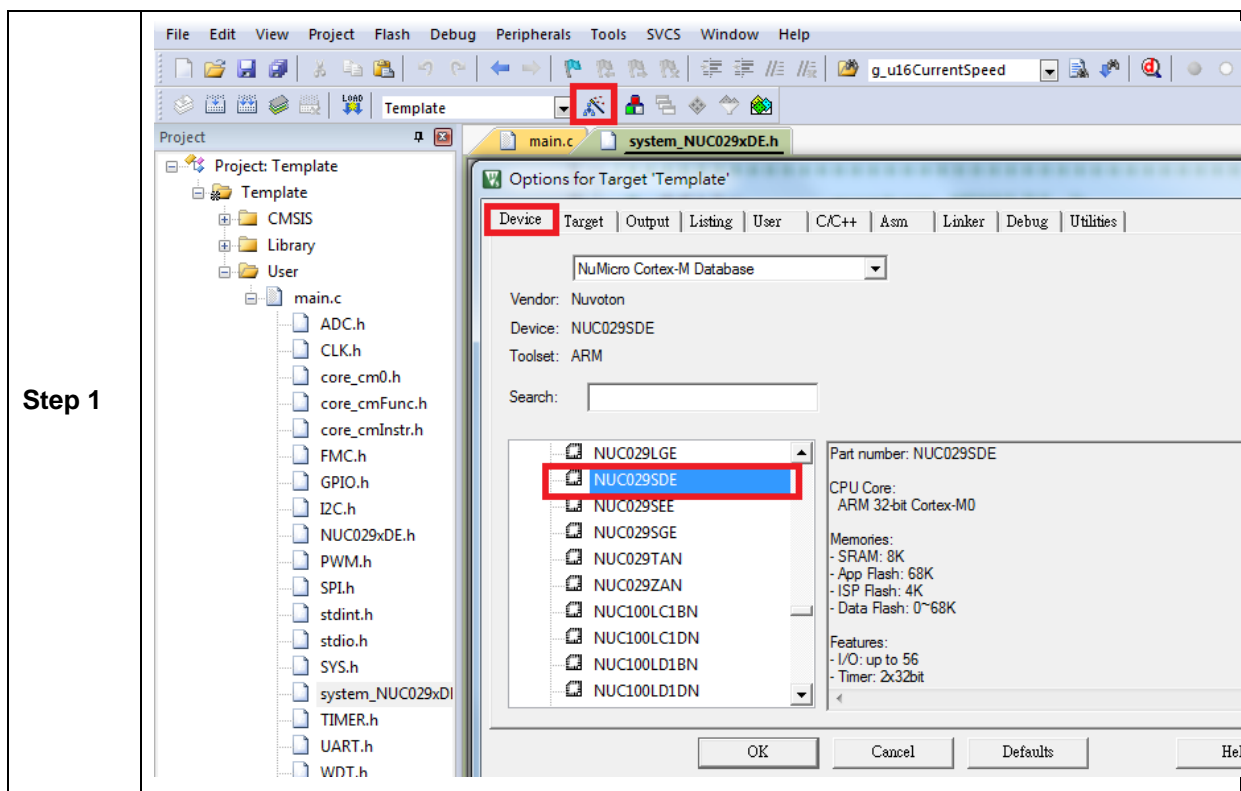

Figure 5-4 Using UART on Keil  $\mu$ Vision<sup>®</sup> IDE

### 5.3.2 Check the Target Device and Debug Setting

The target device has to be the same as the setting in Debug. Please click “Target Option” to open the Option windows, and find the setting in “Device”, “Debug”, and “Utilities” page. Please follow the steps below to check the setting.



Step 2

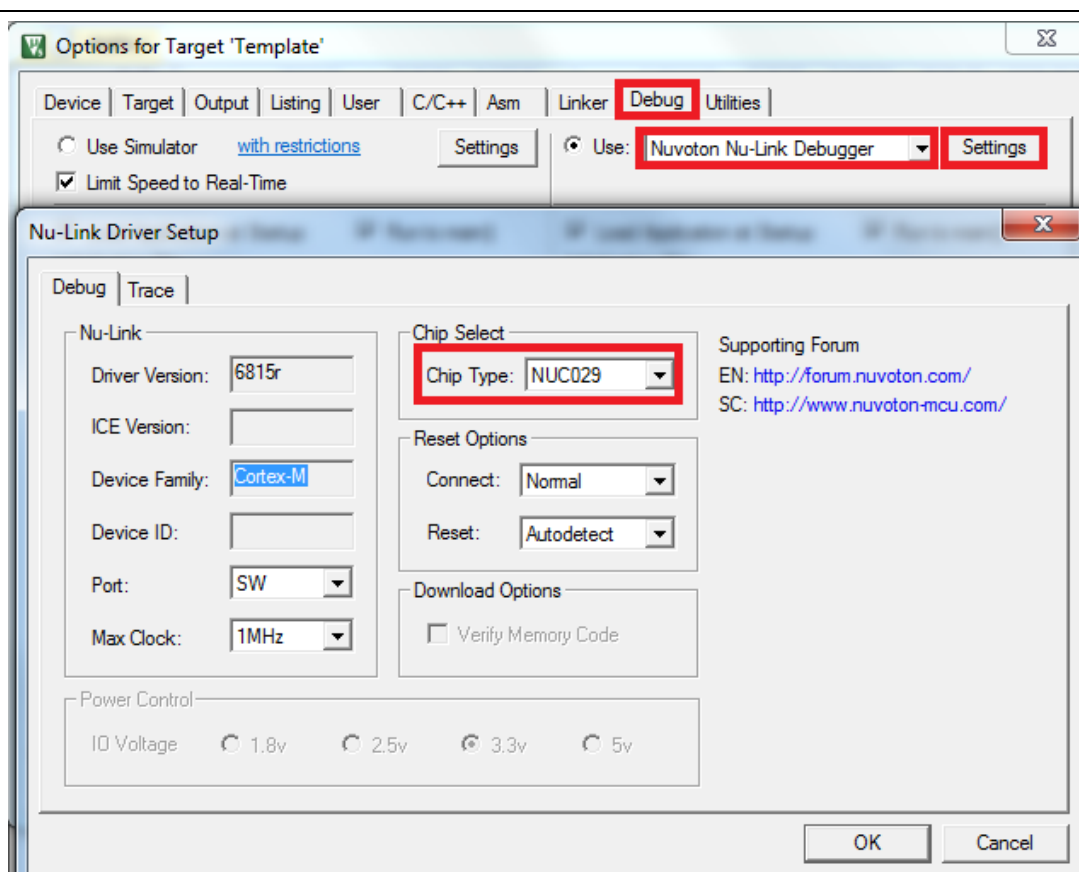

Step 3

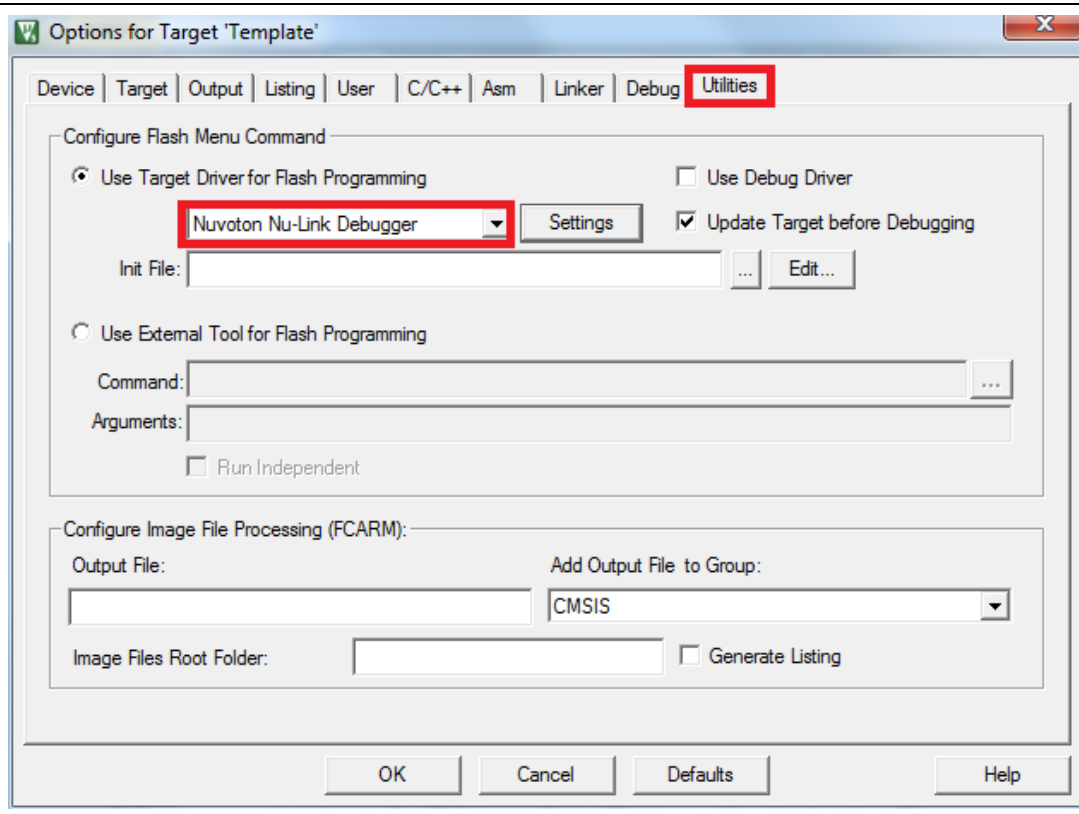

NUC029SDE USER MANUAL

### 5.3.3 Build and Download Code to NuTiny-SDK-NUC029SDE

Please build the project and download code to the NuTiny-SDK-NUC029SDE.

### 5.3.4 Open the Serial Port Terminal

User can use serial port terminal, PuTTY for example, to print out debug message.

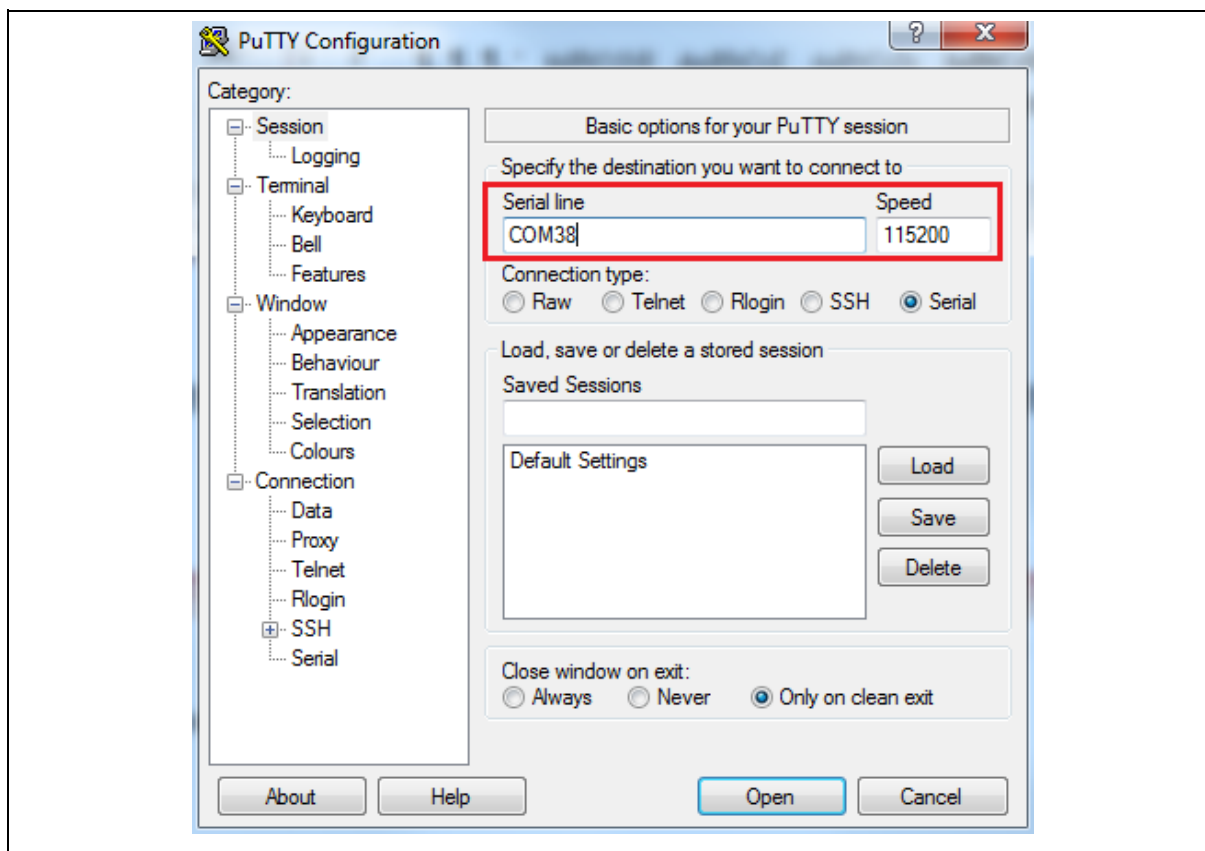

Figure 5-5 Set Baud Rate

### 5.3.5 Reset Chip

After pushing the reset button, the chip will reprogram application and print out debug message.

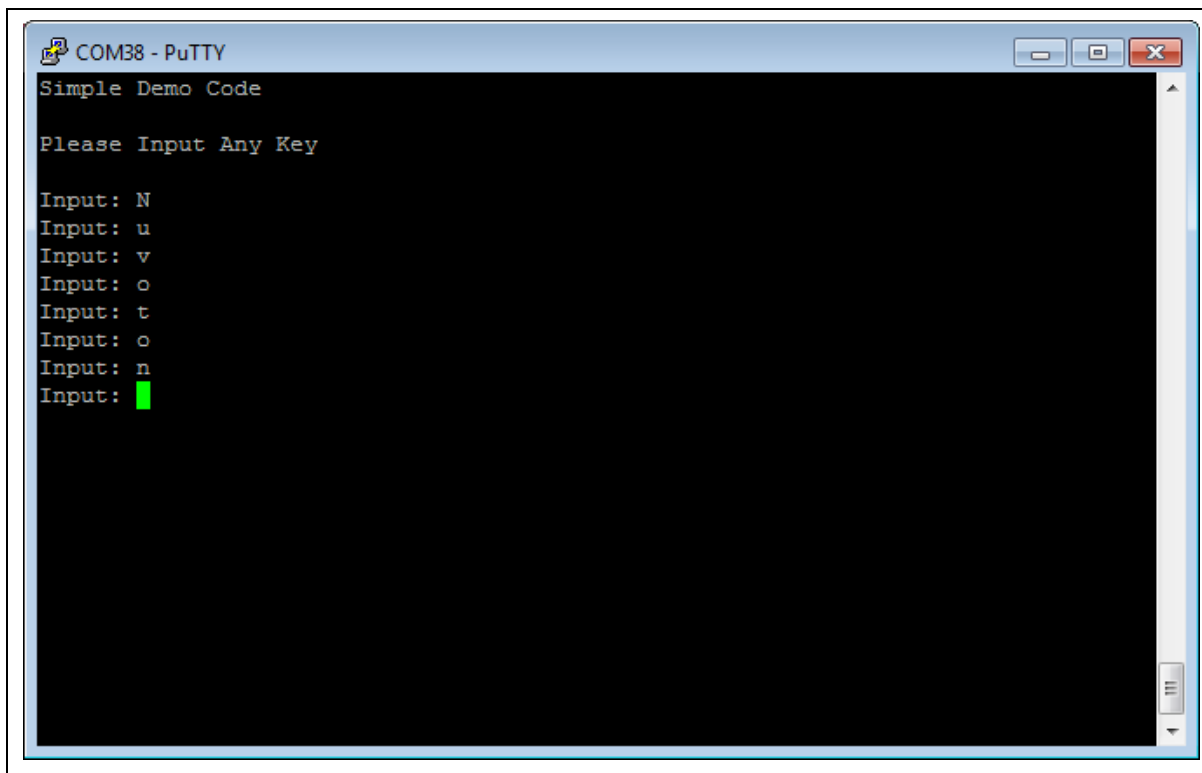
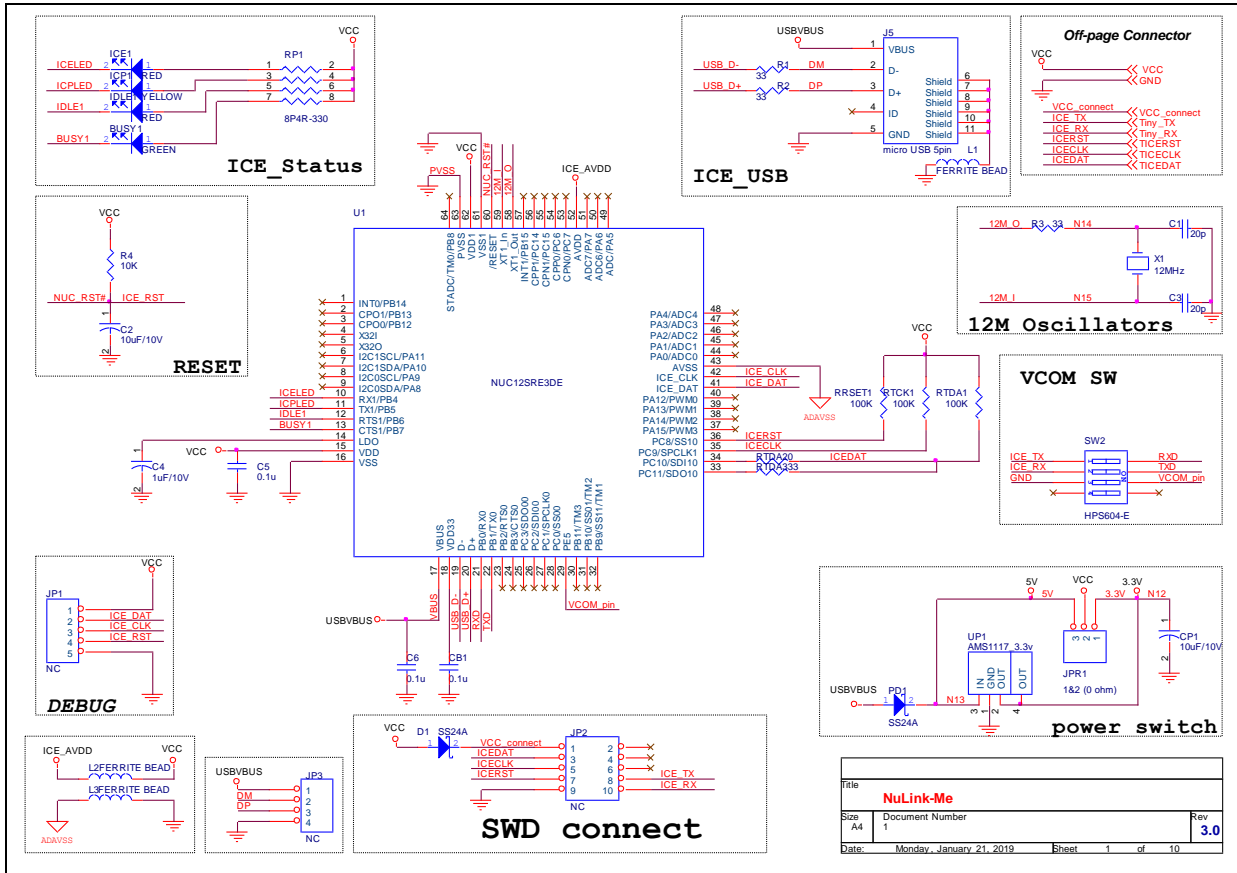

Figure 5-6 Serial Port Terminal Windows

**Note:** Please switch SW2 on before the NuTiny-SDK-NUC029SDE is connected to the PC. When the NuTiny-SDK-NUC029SDE is connected to the PC with SW2 switch on, PC will detect VCOM as a USB device and the detection will only be processed once. VCOM will not function if SW2 switched on after the connection.

## 6 NUTINY-SDK-NUC029SDE SCHEMATICS

### 6.1 Nu-Link-Me V3.0 Schematic



NUTINY-SDK-NUC029SDE USER MANUAL

### 6.2 GPIO for 64 pin Schematic

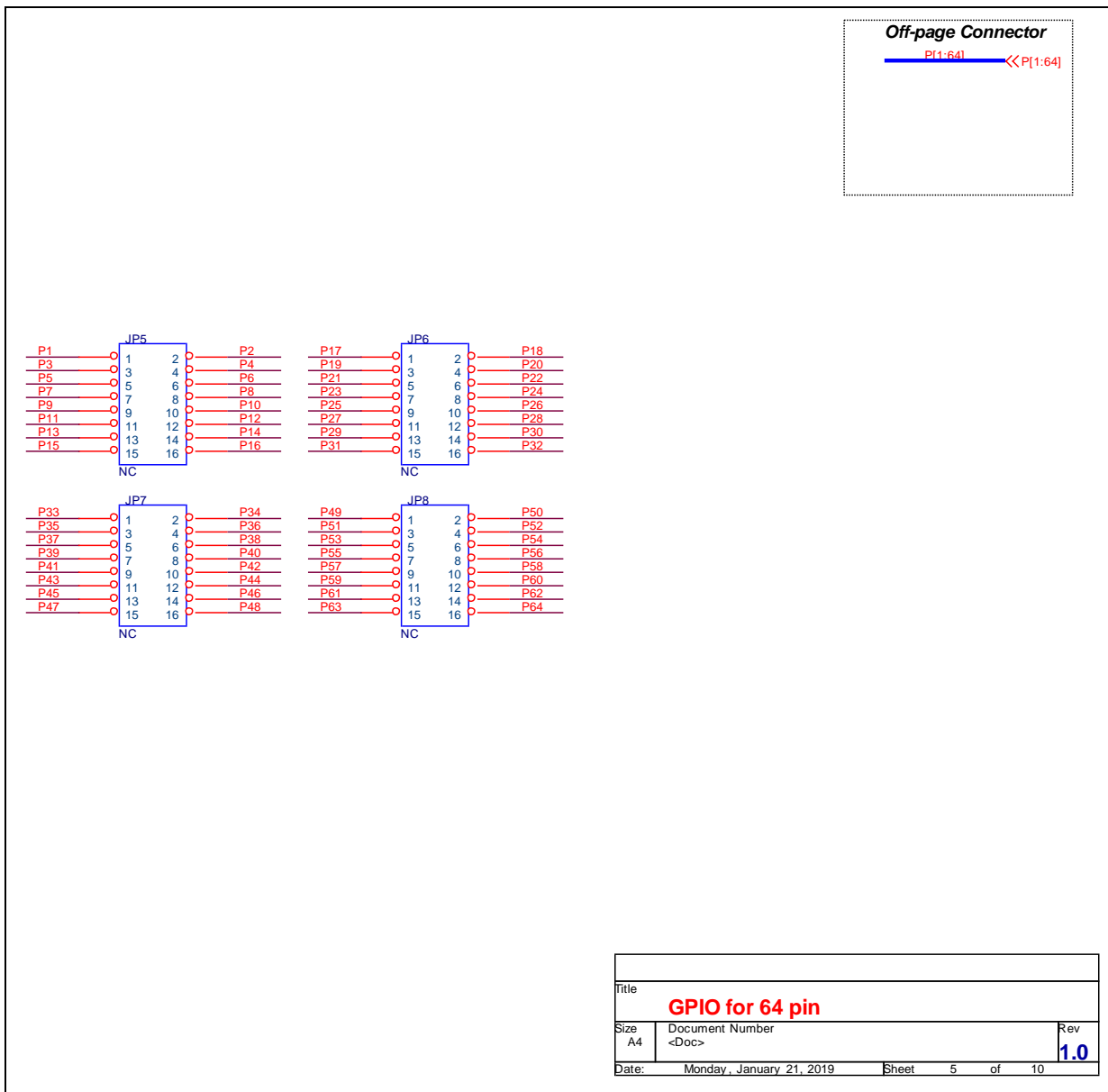



### 6.3 SDK Circuit Schematic

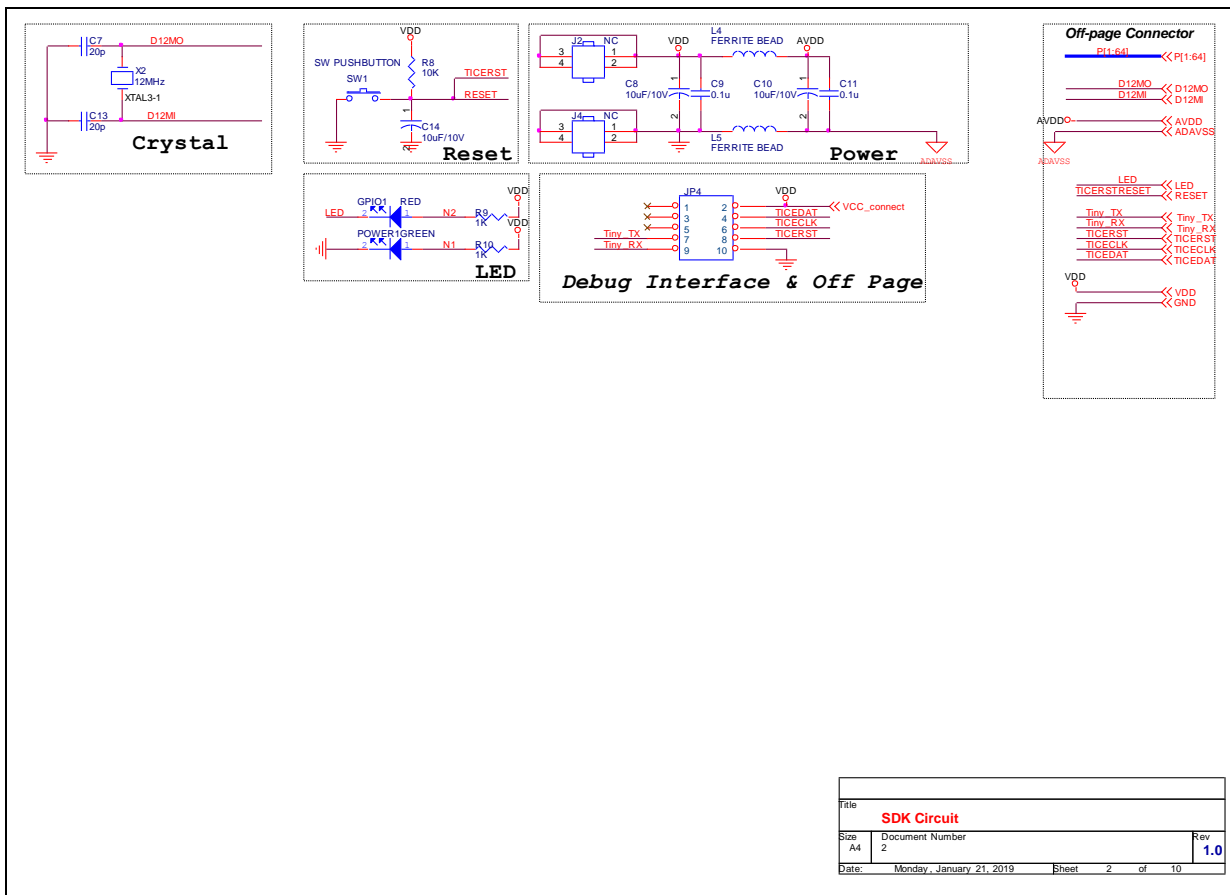

File		
SDK Circuit		
Size	Document Number	Rev
A4	2	1.0
Date:	Monday, January 21, 2019	Sheet 2 of 10

6.4 Target Chip

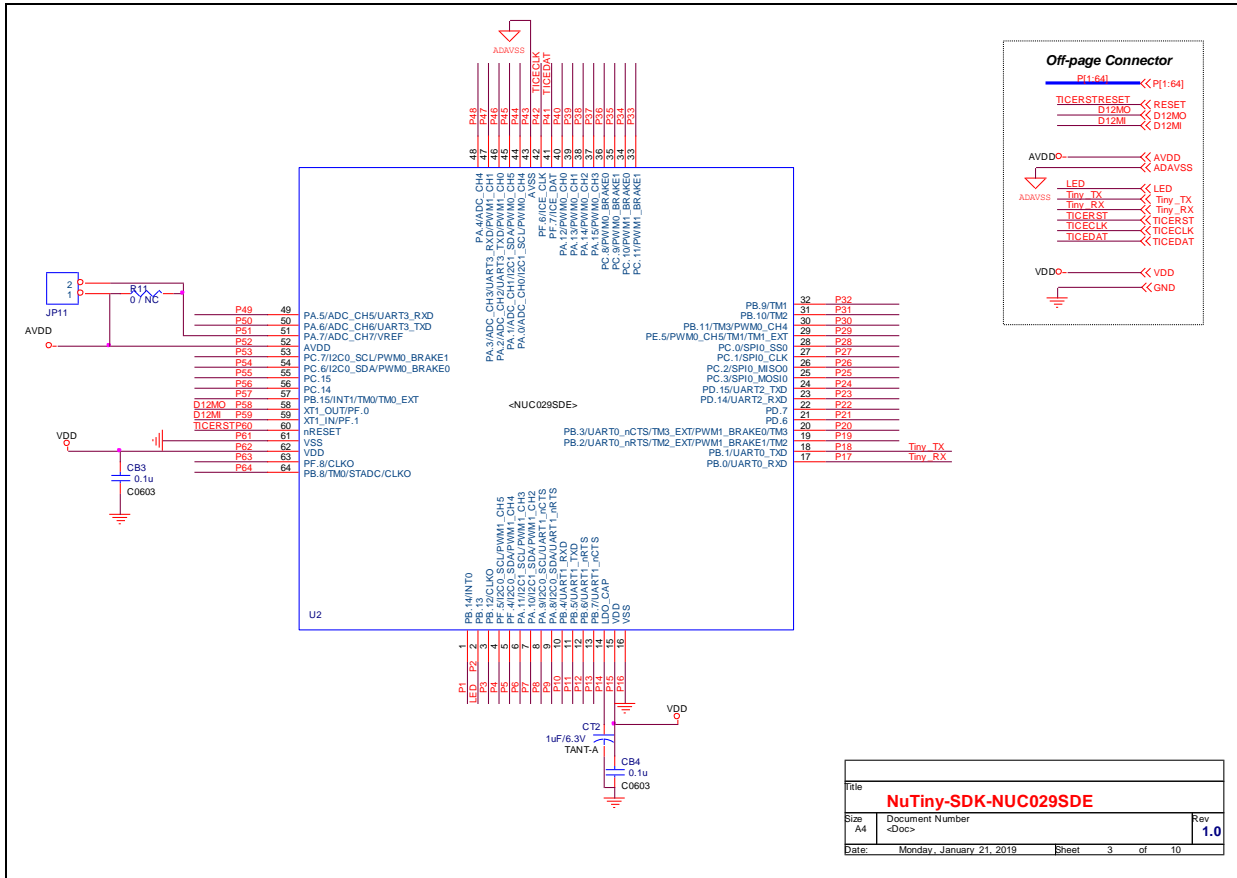

**7 REVISION HISTORY**

Date	Revision	Description
2019.01.21	1.00	1. Initially issued.

### Important Notice

Nuvoton Products are neither intended nor warranted for usage in systems or equipment, any malfunction or failure of which may cause loss of human life, bodily injury or severe property damage. Such applications are deemed, "Insecure Usage".

Insecure usage includes, but is not limited to: equipment for surgical implementation, atomic energy control instruments, airplane or spaceship instruments, the control or operation of dynamic, brake or safety systems designed for vehicular use, traffic signal instruments, all types of safety devices, and other applications intended to support or sustain life.

All Insecure Usage shall be made at customer's risk, and in the event that third parties lay claims to Nuvoton as a result of customer's Insecure Usage, customer shall indemnify the damages and liabilities thus incurred by Nuvoton.

---

*Please note that all data and specifications are subject to change without notice.  
All the trademarks of products and companies mentioned in this datasheet belong to their respective owners.*