

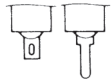





EIGHT SWITCH SERIES

8 Switch Series Selection Table

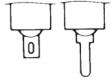
Part No.	Name	Actuator shape	Number of poles	Switching function	Terminal style	Page
8H	Lever · Rocker		1 · 2	ON — ON ON — OFF — ON (ON) — OFF — (ON) ON — (ON)	 S/D P/C	338
8HD	Lever · Rocker (Dust Proof)		1 · 2		 S/D P/C	340
8M	Small Lever Rocker		1 · 2 · 3 · 4		 S/D	342
8V—M	Small Lever · Rocker PC		1 · 2		 P/C	344

●S/D : Show Solder terminal.
 ●P/C : Show PC terminal.

Note: For overseas standards, see page 575.

8 Switch Series Common Specifications

Contact specs.		Silver	Gold plated
Rating	Max.	125VAC 6A 250VAC 3A 30VAC 4A	20VDC 25mA
Initial contact resistance		10mΩ Max. (2~4VDC 1A)	20mΩ Max. (200 μVAC 1.5mA)
Initial dielectric strength		AC1500V 1 Minute	
Initial insulation resistance		1000MΩ Min.	(500VDC)
Electrical life	Alternate type	50,000 cycles	
	Momentary type	25,000 cycles	
Operating temperature range		-30~+85°C	
Storage temperature range		-40~+85°C	

Part Numbering

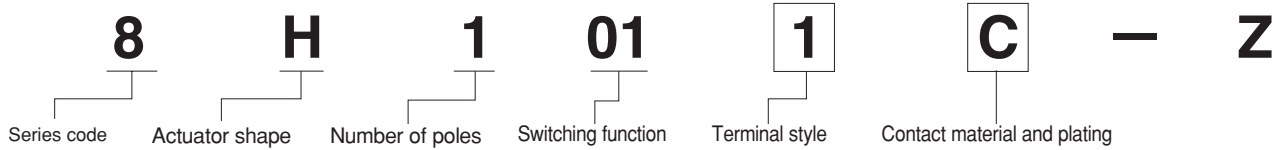

Code	Type
H	Lever•Rocker
HD	Lever•Rocker
M	Small Lever•Rocker
V-M	Small Lever•Rocker

Fig.	Number of poles
1	1 pole
2	2 poles
3	3 poles
4	4 poles

Fig.	Switching function
01	ON - ON
02	ON - OFF - ON
04	(ON)-OFF-(ON)
06	ON - (ON)

Fig.	Terminal style
1	Solder Terminal
2	PC Straight

Code	Contact material	Plating
None	Bs+Ag or Cu+Ag	Ag
C	Bs+Ag or Cu+Ag	Ni+Au

Bs=Brass.
 Cu=Copper.
 Ag=Silver.
 Ni=Nickel.
 Au=Gold

Note : For some products, the part numbers according to the above-stated combinations are not registered yet. Check the Table of Part Numbers for availability.

Terminal Styles

Terminal style	Solder Terminal (Style : 1)	PC Straight (Style : 2)
Dimensions		

PC Hole Layouts

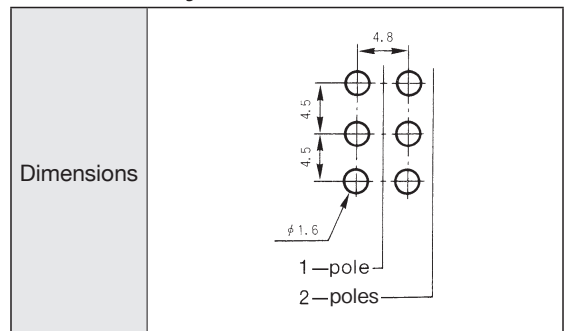

8V-M/PC Hole Layouts

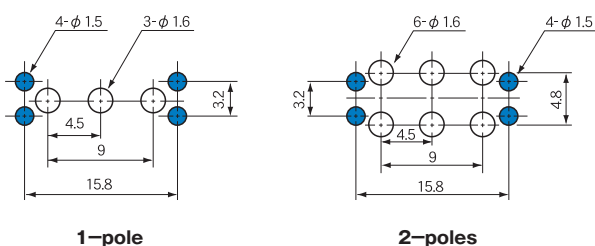

(ON) : Momentary.

8M

Small Lever & Rocker Switches

UL CSA

RoHS Compliant

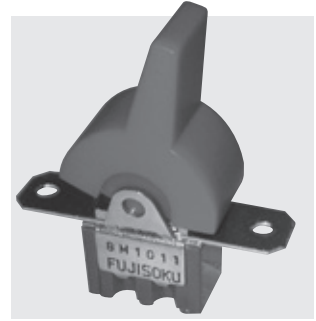

■ Features

The 8M Small Lever & Rocker Switch is similar to the 8A type except that 8M type has a mounting plate. Levers and rockers are available in four matted colors that give a sober atmosphere. Choose the suitable one for the panel design. For the mounting method, see the following figure.

■ Mounting Method

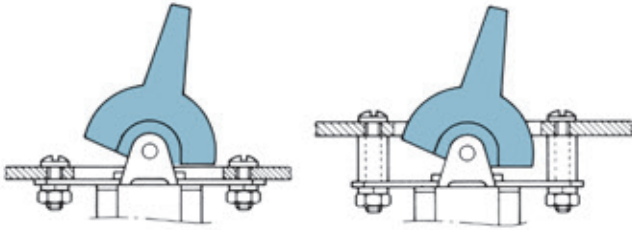

■ Standard Accessories

《Supplied separately》

Part name	Lever	Rocker
Dimensions	<p>polycarbonate resin</p> <p>Matte finish</p>	<p>polycarbonate resin</p> <p>Matte finish</p>
White	140000050427	140000480509
Red	140000050428	140000480510
Black	140000050429	140000480511
Gray	140000050450	140000480522
Panel Cut-Out Dimensions		

● Specify either one of Lever or Rocker in part number when placing an order.

■ Mounting the Lever & Rocker

Press the selvage part of the lever/rocker with a screwdriver to fix it.

Some products in the Table of UL and CSA-Approved Products are not registered yet. Before placing the order, check with our Sales Department.

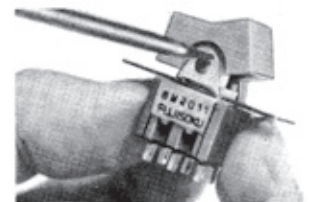

SPDT

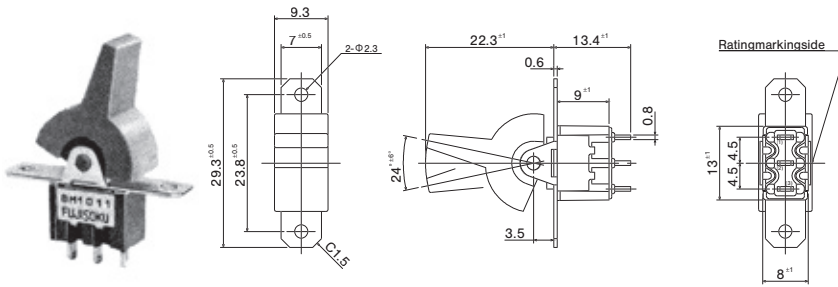

Switching function	Viewed from rating marking side		
Part No.	8M1011-Z	ON	ON
Connecting terminals	2-3	-	2-1

(Mount with Lever)

Terminal numbers are not shown on the bottom of the switch.

DPDT

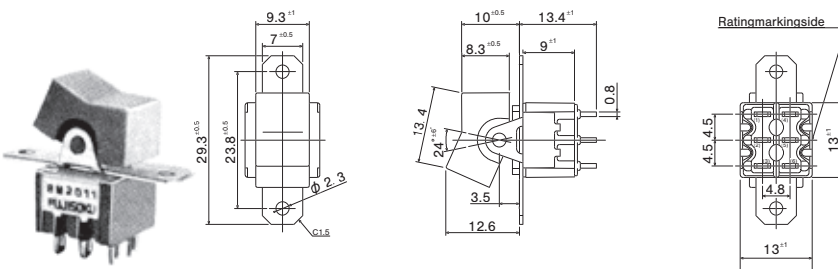

Switching function	Viewed from rating marking side		
Part No.	8M2011-Z	ON	ON
Connecting terminals	2-3 5-6	-	2-1 5-4

(Mount with Rocker)

Terminal numbers are not shown on the bottom of the switch.

3PDT

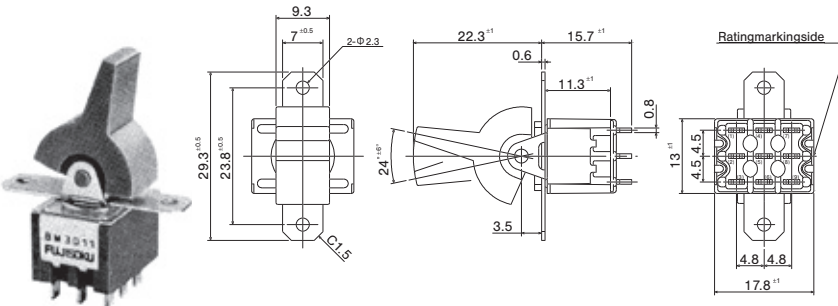

Switching function	Viewed from rating marking side		
Part No.	☆ 8M3011-Z	ON	ON
Connecting terminals	2-3 5-6 8-9	-	2-12 5-4 8-7

(Mount with Lever)

Terminal numbers are not shown on the bottom of the switch.

4PDT

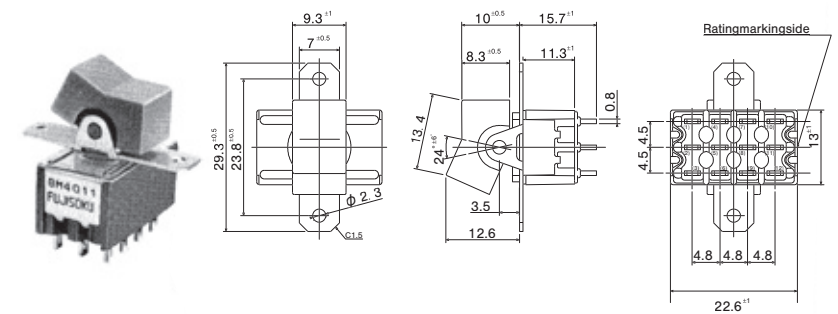

Switching function	Viewed from rating marking side		
Part No.	☆ 8M4011-Z	ON	ON
Connecting terminals	2-3 5-6 8-9 11-12	-	2-1 5-4 8-7 11-10

(Mount with Rocker)

Terminal numbers are not shown on the bottom of the switch.

UL、CSA認定品一覧表 (Lever・Rocker Type Only)

UL and CSA listed

■エイトスイッチシリーズ/8Switch Series

Poles	Switching function			UL (File No.E43275)				CSA (File No.LR38341)				
				8H	8HD	8M	8V-M	8H	8HD	8M	8V-M	
1-pole	101□	ON	—	ON	○	○	○	○	○	○	○	○
	102□	ON	—	OFF —	ON	○				○		
	104□	(ON)	—	OFF —	(ON)	○	○			○	○	
	106□	ON	—	(ON)		○			○	○		○
2-poles	201□	ON	—	ON	○	○	○	○	○	○	○	○
	202□	ON	—	OFF —	ON	○	○			○	○	
	204□	(ON)	—	OFF —	(ON)	○				○		
	206□	ON	—	(ON)		○			○	○		○
3-poles	301□	ON	—	ON			○				○	
4-poles	401□	ON	—	ON			○				○	

- (1) □ shows the terminal type of ① : Solder terminal; ② : PC terminal.
- (2) Some products in the Table of UL and CSA Listed are not registered yet. Before placing the order, check with our Sales Department.
- (3) For the registered products, refer to Table of Part Numbers of respective Series products.
- (4) When the UL and CSA approved products are required, specify "UL /CSA approved Product" when placing the order. The products will be delivered with the UL or CSA marking.

■Handling Precautions(EIGHT switch series)

1. Soldering Specifications

- (1) Soldering Specifications
Device : Soldering iron
① 420°C, Max.; 3 sec., Max.
- (2) Auto Soldering
② 275°C ± 10°C, Max.; 5 seconds, Max.
Note that the above-stated soldering conditions should be applied to the PC terminal type only.

3. Mounting

- Do not bend the terminals before mounting the switch on the PC board.
- After mounting the switch, do not place the device in such a way that the device weight will be applied on the knob of the switch.
- To fix the PC terminal type, solder it on the PC board after fixing the switch body on the panel with the screw.

2. Flux Cleaning

- (1) For the solvent, use the fluorine- or alcohol-based solvent.
Solvent: Fluorine or Alcohol type
- (2) Since the 8 Switch Series switches are not waterproof-structured, if the PC board is to be cleaned, clean the soldering surface of substrate with a brush so that the switch is not exposed to the cleaning solution.