

CGHV35060MP

60 W, 2700-3800 MHz, 50 V GaN HEMT for S Band Radar and LTE Base Stations

Description

CGHV35060MP is a 60 W input matched, gallium nitride (GaN) high electron mobility transistor (HEMT) optimized for S Band performance. The CGHV35060MP is suitable for typical bands of 2.7-3.1 GHz and 3.1-3.5 GHz while the input matched transistor provides optimal gain, power and efficiency in a small 6.5 mm x 4.4 mm plastic surface mount (SMT) package. The typical performance plots in the datasheet are derived with CGHV35060MP matched into a 3.1-3.5 GHz high power amplifier.

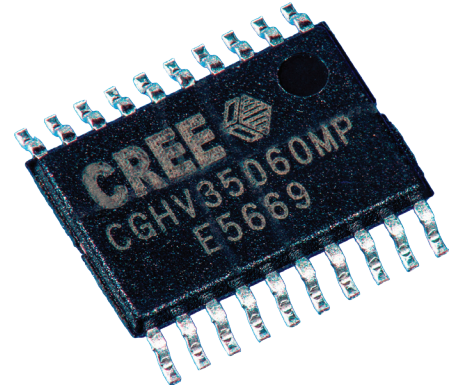

PN: CGHV35060MP

Typical Performance Over 3.1 - 3.5 GHz ($T_c = 25^\circ\text{C}$) of Demonstration Amplifier

Parameter	3.1 GHz	3.3 GHz	3.5 GHz	Units
Gain	14.5	14.3	13.8	dB
Output Power	88	88	75	W
Drain Efficiency	61	67	64	%

Note: Measured in the CGHV35060MP-AMP1 amplifier circuit, under 100 μs pulse width, 10% duty cycle, $P_{in} = 35\text{ dBm}$

Features

- Reference design amplifier 3.1 - 3.5 GHz
- 75W Typical output power
- 14.5 dB power gain
- 67% Drain efficiency
- Internally pre-matched on input, unmatched output

 Large Signal Models Available for ADS and MWO

RoHS
COMPLIANT



Absolute Maximum Ratings (not simultaneous) at 25 °C Case Temperature

Parameter	Symbol	Rating	Units	Conditions
Drain-Source Voltage	V_{DS}	150	Volts	25 °C
Gate-to-Source Voltage	V_{GS}	-10, +2	Volts	25 °C
Storage Temperature	T_{STG}	-65, +150	°C	
Operating Junction Temperature	T_J	225	°C	
Maximum Forward Gate Current	I_{GMAX}	10.4	mA	25 °C
Maximum Drain Current ¹	I_{DMAX}	6.3	A	25 °C
Soldering Temperature ²	T_S	245	°C	
CW Thermal Resistance, Junction to Case ³	$R_{\theta JC}$	2.6	°C/W	85 °C, $P_{DISS} = 52$ W
Pulsed Thermal Resistance, Junction to Case	$R_{\theta JC}$	1.95	°C/W	85 °C, $P_{DISS} = 62$ W, 100 μ sec 10%
Case Operating Temperature ⁴	T_C	-40, +107	°C	CW

Notes:

¹ Current limit for long term, reliable operation

² Refer to the Application Note on soldering at wolfspeed.com/rf/document-library

³ Measured for the CGHV35060MP

⁴ See also, the Power Dissipation De-rating Curve on Page 4

Electrical Characteristics ($T_C = 25^\circ\text{C}$)

Characteristics	Symbol	Min.	Typ.	Max.	Units	Conditions
DC Characteristics¹						
Gate Threshold Voltage	$V_{GS(th)}$	-3.8	-3.0	-2.3	V_{DC}	$V_{DS} = 10$ V, $I_D = 10.4$ mA
Gate Quiescent Voltage	$V_{GS(Q)}$	-	-2.7	-	V_{DC}	$V_{DS} = 50$ V, $I_D = 125$ mA
Saturated Drain Current ²	I_{DS}	8.4	10.4	-	A	$V_{DS} = 6.0$ V, $V_{GS} = 2.0$ V
Drain-Source Breakdown Voltage	V_{BR}	125	-	-	V_{DC}	$V_{GS} = -8$ V, $I_D = 10.4$ mA
RF Characteristics⁴ ($T_C = 25^\circ\text{C}$, $F_0 = 3.225$ GHz unless otherwise noted)						
Saturated Output Power ^{3,6}	P_{SAT}	55	75	-	W	$V_{DD} = 50$ V, $I_{DQ} = 125$ mA, $P_{IN} = 34.5$ dBm
Pulsed Drain Efficiency ^{3,6}	η	46	59.1	-	%	$V_{DD} = 50$ V, $I_{DQ} = 125$ mA, $P_{IN} = 34.5$ dBm
Gain ^{3,6}	G	14.35	16.3	-	dB	$V_{DD} = 50$ V, $I_{DQ} = 125$ mA, $P_{IN} = 10$ dBm
Output Mismatch Stress ³	VSWR	-	-	10:1	Ψ	No damage at all phase angles, $V_{DD} = 50$ V, $I_{DQ} = 125$ mA, $P_{OUT} = 60$ W Pulsed
Dynamic Characteristics						
Input Capacitance ⁵	C_{GS}	-	32.16	-	pF	$V_{DS} = 50$ V, $V_{GS} = -8$ V, $f = 1$ MHz
Output Capacitance ⁵	C_{DS}	-	4.4	-	pF	$V_{DS} = 50$ V, $V_{GS} = -8$ V, $f = 1$ MHz
Feedback Capacitance	C_{GD}	-	0.5	-	pF	$V_{DS} = 50$ V, $V_{GS} = -8$ V, $f = 1$ MHz

Notes:

¹ Measured on wafer prior to packaging

² Scaled from PCM data

³ Pulse Width = 100 μ s, Duty Cycle = 10%

⁴ Measured in CGHV35060MP high volume test fixture

⁵ Includes package

⁶ Includes offsets correlating data taken in high volume test fixture to data taken in application circuit with device soldered down



Typical Performance

Figure 1. Small Signal Gain and Return Losses vs Frequency
 Measured in Demonstration Amplifier Circuit CGHV35060MP-AMP1

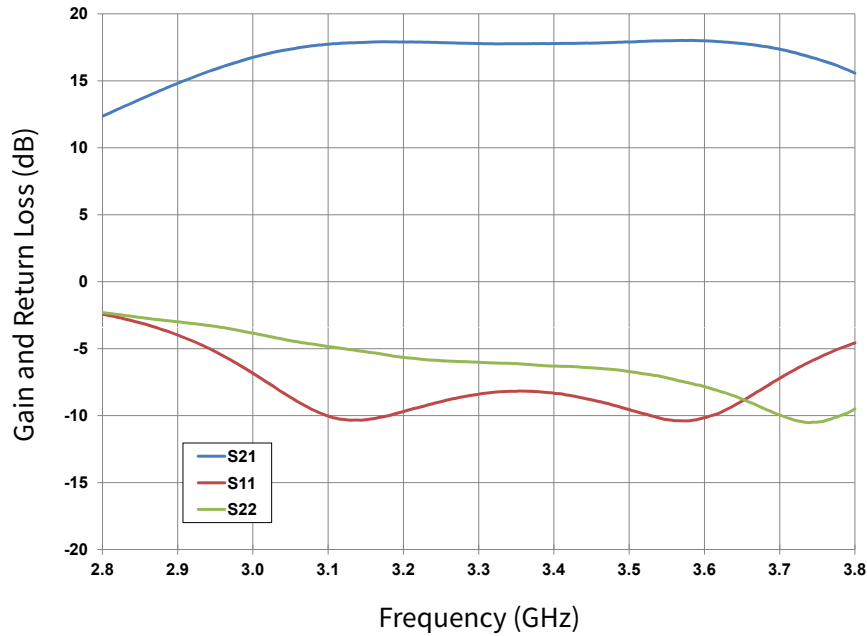
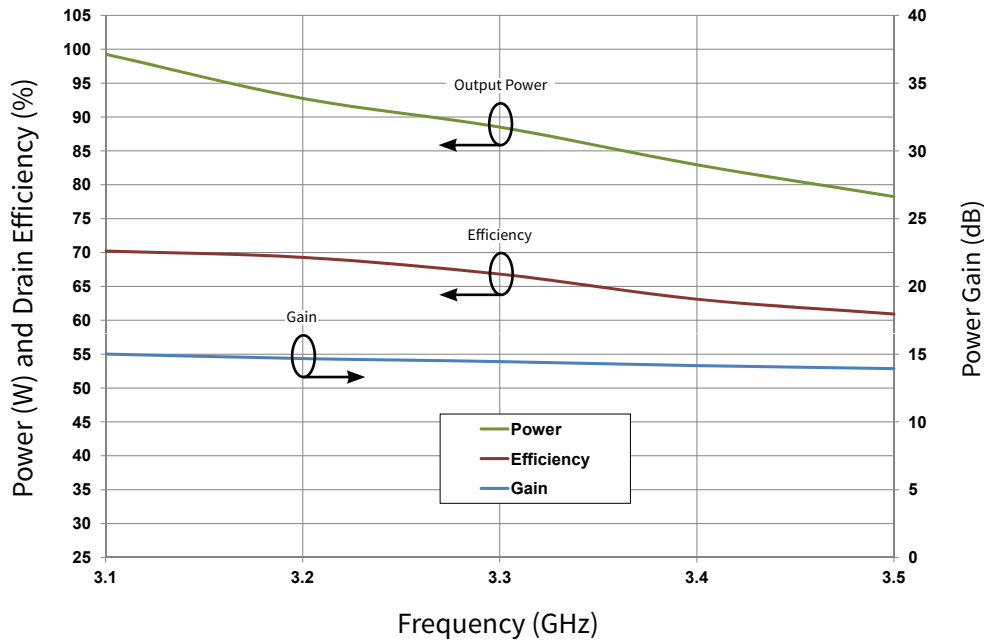

Figure 2. Gain, Efficiency & Output Power vs Frequency
 $V_{DD} = 50\text{ V}$, $I_{DQ} = 125\text{ mA}$, Pulse Width = 100 us, Duty Cycle = 10%, $T_{case} = 25^\circ\text{C}$





Typical Performance

Figure 3. CGHV35060MP-AMP1 Output Power vs. Input Power
 $V_{DD} = 50\text{ V}$ $I_{DQ} = 125\text{ mA}$, Pulse Width = 100 us, Duty Cycle = 10%, Tcase = 25°C

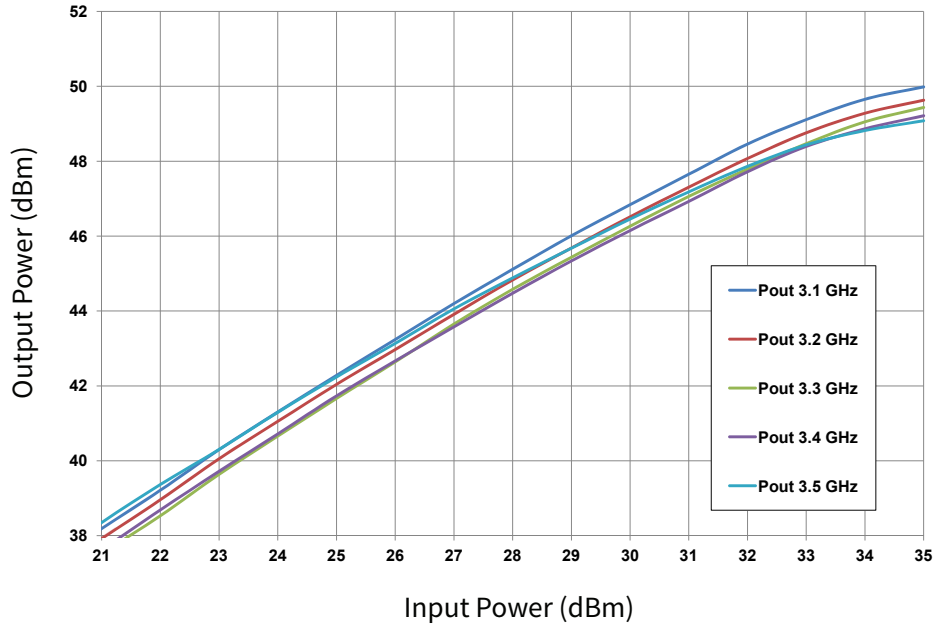
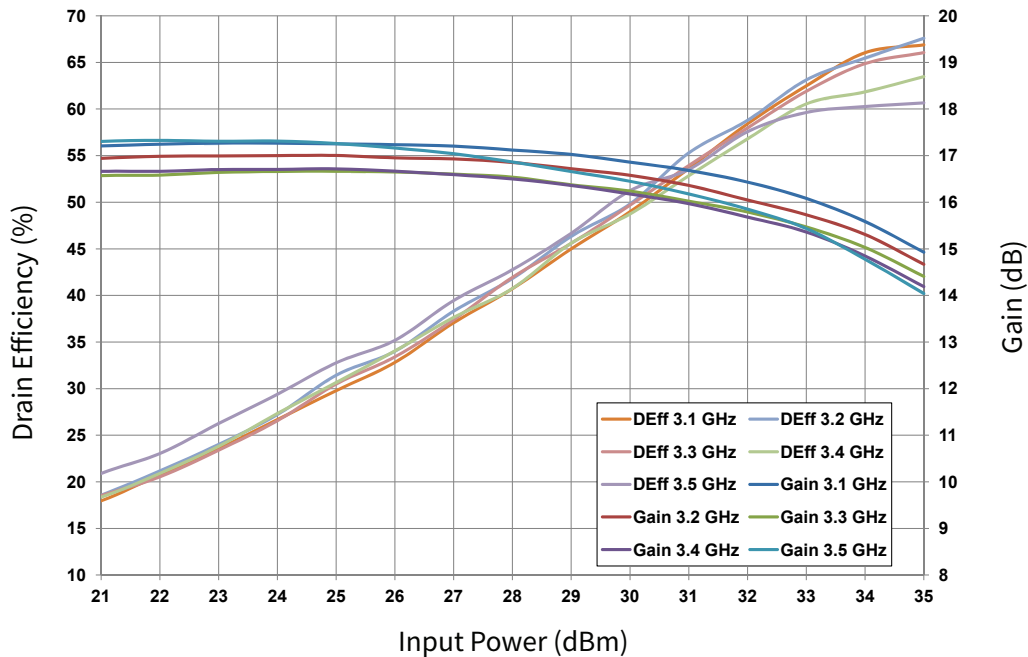

Figure 4. CGHV35060MP-AMP1 Gain & Efficiency vs Input Power
 $V_{DD} = 50\text{ V}$ $I_{DQ} = 125\text{ mA}$, Pulse Width = 100 us, Duty Cycle = 10%, Tcase = 25°C





Typical Performance

Figure 5. CGHV35060MP-AMP1 T_{j_rise} vs. Input Power
 $V_{DD} = 50\text{ V}$, $I_{DQ} = 125\text{ mA}$, Pulse Width = 100 us, Duty Cycle = 10%, T_{case} = 25°C

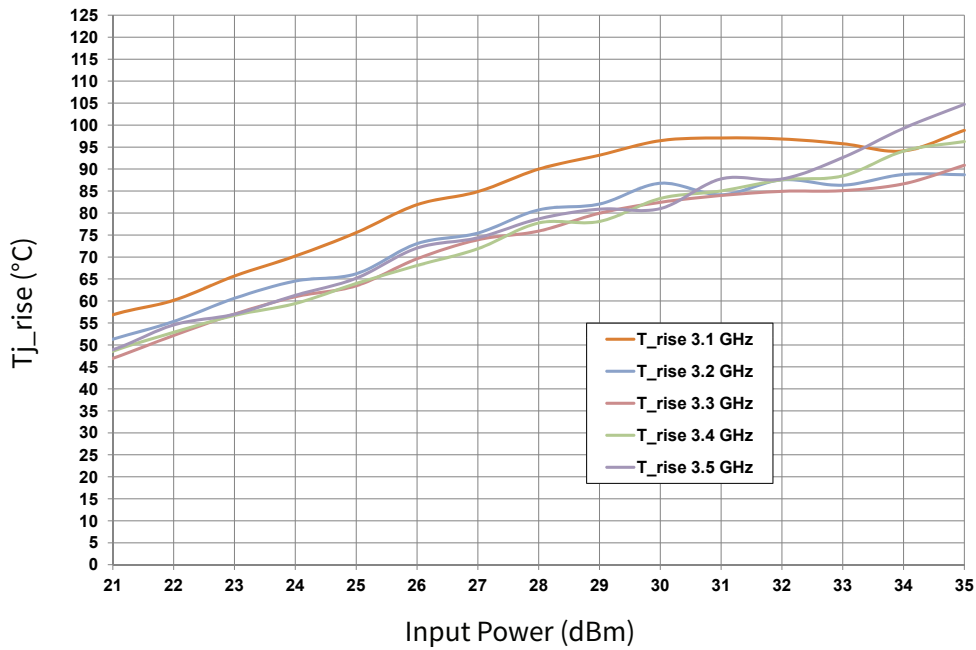
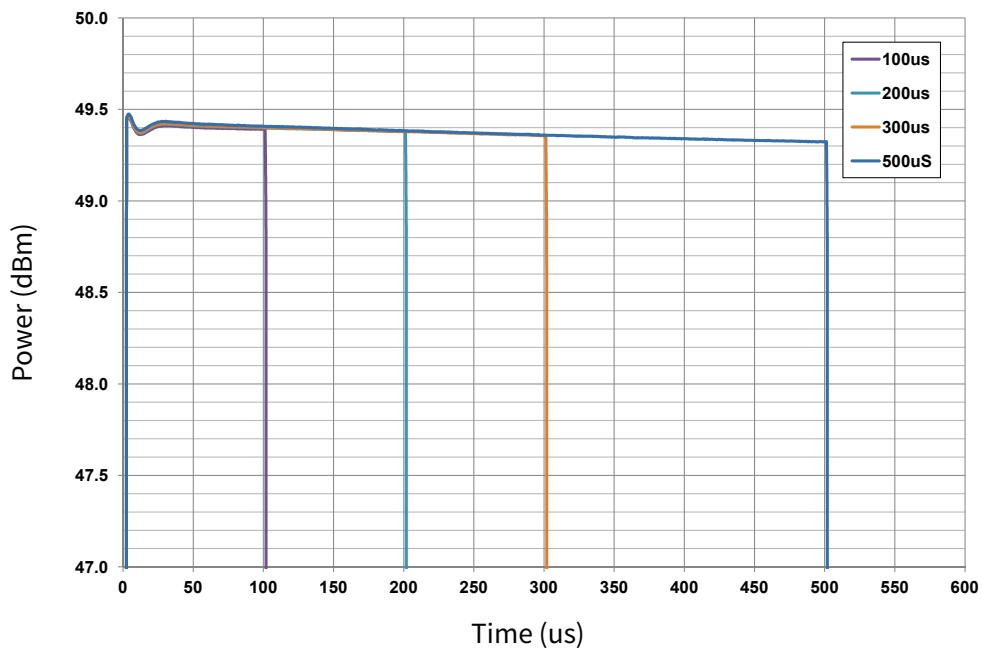
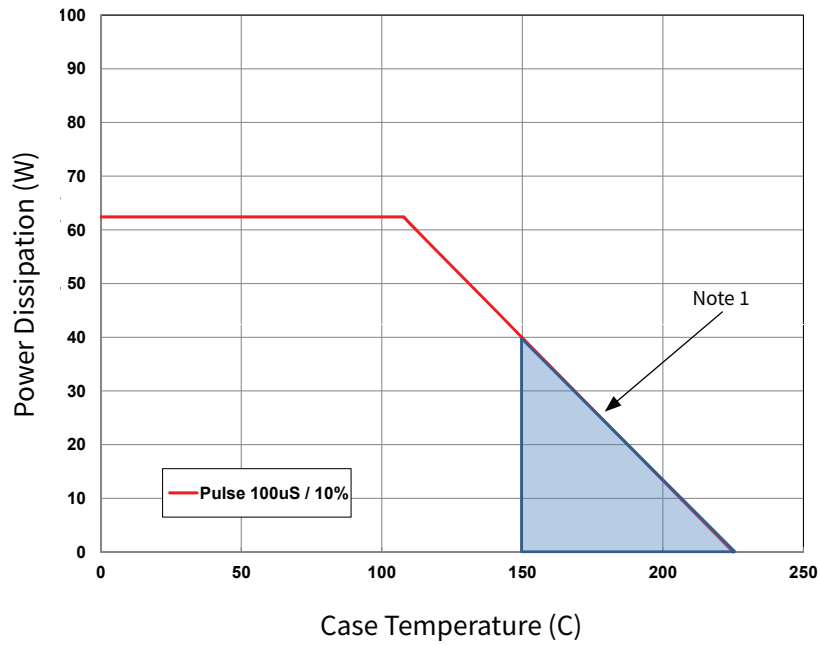

Figure 6. CGHV35060MP-AMP1 Output Power vs. Time, Varying Pulse Lengths
 $V_{DD} = 50\text{ V}$, $P_{IN} = 35\text{ dBm}$, Duty Cycle = 10%





CGHV35060MP Power Dissipation De-rating Curve



Note 1. Area exceeds Maximum Case Temperature (See Page 2)

CGHV35060MP-AMP1 Application Circuit Bill of Materials

Designator	Description	Qty
R1	RES,1/16W,0603,1%,150 OHMS	1
R20,R21	RES,1/16W,0603,1%,10.0 OHMS	2
C1	CAP, 2.2pF, +/-0.1pF, 0603, ATC	1
C2,C20-C30	CAP, 10.0pF, +/-5%, 0603, ATC	12
C3,C4	CAP, 1.3pF, +/-0.1pF, 0603, ATC	2
C11,C14	CAP, 0.7pF, +/-0.05pF, 0603, ATC	2
C13,C12	CAP, 0.9pF, +/-0.05 pF, 0603, ATC	2
C15,C16	CAP, 1.0pF, +/-0.05pF, 0603, ATC	2
C17	CAP, 0.1pF, +/-0.05pF, 0603, ATC	1
C41,C42,C43	CAP CER 2.2UF 100V 10% X7R 1210	3
C51,C53	CAP CER 10UF 100V 20% X7S 2220	2
C61	CAP, 33 UF, 20%, G CASE, 100V	1
J1,J2	SMA PANEL RECEPTACLE JACK	2
J3	HEADER RT>PLZ .1CEN LK 5POS	1
	Cu BASEPLATE 2.6 x 1.7 x 0.25" WITH PEDESTAL FOR GULLWING eTSSOP	1
	PCB, TEST FIXTURE, RO4350, .020 THK, CGHV35060MP	1
	2-56 SOC HD SCREW 1/4 SS	4
	#2 SPLIT LOCKWASHER SS	4
	PREFORM, eTSSOP, 0.174 x 0.130 x 0.005	1
Q1	60W, GaN HEMT TSSOP 20L, 2.7 -3.5GHz, 50V PLASTIC, "CGHV35060MP"	1



CGHV35060MP-AMP1 Application Circuit Outline

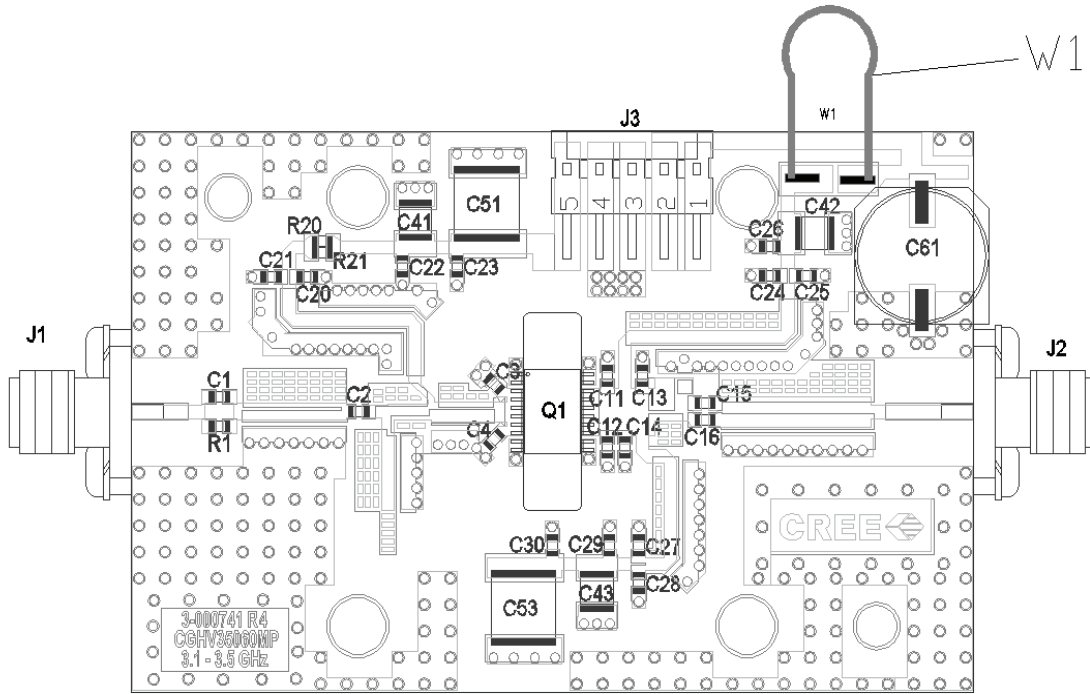

CGHV35060MP-AMP1 Application Circuit Schematic

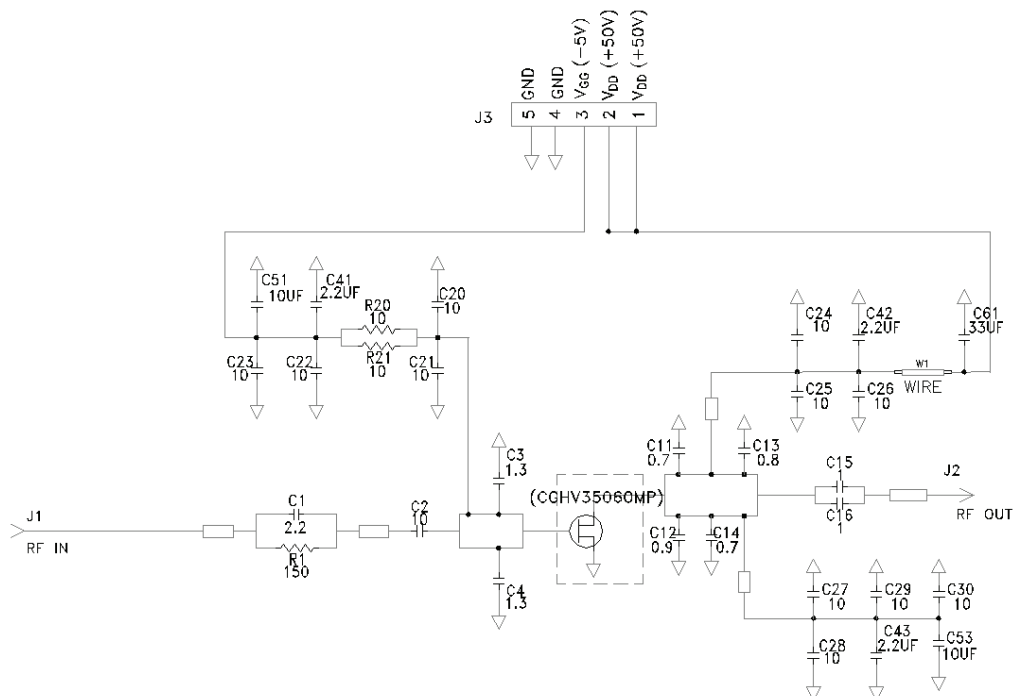



Product Dimensions CGHV35060MP (4.4 mm TSSOP 20-Lead Package)

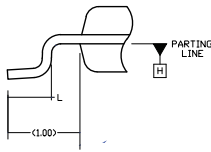
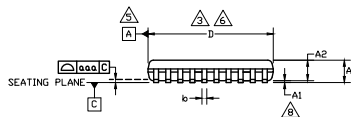
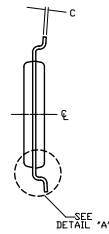
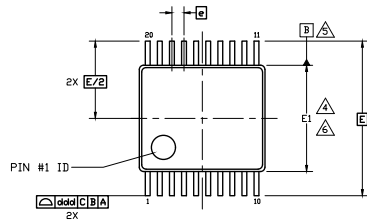

DETAIL 'A'
(VIEW ROTATED 90° C.W.)

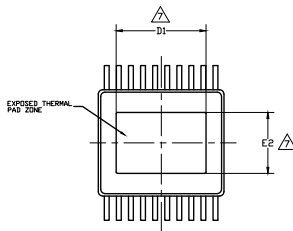

NOTES:

1. ALL DIMENSIONS ARE IN MILLIMETERS (ANGLES IN DEGREES).
2. DIMENSIONING & TOLERANCES PER ASME, Y14.5M-1994.
- △ DIMENSION 'D' DOES NOT INCLUDE MOLD FLASH, PROTRUSIONS OR GATE BURRS. MOLD FLASH, PROTRUSIONS OR GATE BURRS SHALL NOT EXCEED 0.15 PER SIDE.
- △ DIMENSION 'E1' DOES NOT INCLUDE INTERLEAD FLASH OR PROTRUSION. INTERLEAD FLASH OR PROTRUSION SHALL NOT EXCEED 0.25 PER SIDE.
- △ DATUMS A AND B TO BE DETERMINED AT DATUM PLANE H.
- △ DIMENSIONS 'D' AND 'E1' TO BE DETERMINED AT DATUM PLANE H.
- △ 'D1' AND 'E2' DIMENSIONS DO NOT INCLUDE MOLD FLASH.
- △ A1 IS DEFINED AS THE VERTICAL CLEARANCE FROM THE SEATING PLANE TO THE LOWEST POINT ON THE PACKAGE BODY.
9. ALL PLATED SURFACES ARE 100% TIN MATTE FINISH. 0.010 mm +/- 0.005 mm.

PINOUT TABLE

S _v N _a L	COMMON DIMENSIONS			N _d E
	MIN.	NDM.	MAX.	
A			1.15	8
A ₁	0.05		0.15	
A ₂	0.80	0.91	1.02	
aaa	0.076			
b	0.20	-	0.33	
c	0.10	-	0.23	
D	6.40	6.50	6.60	3.6
E1	4.30	4.40	4.50	4.6
e	0.65 BSC			
E	6.40 BSC			
L	0.45	0.60	0.75	
D1	3.61	3.72	3.83	7
E2	2.41	2.52	2.63	7
ddd	0.20			

PIN	FUNCTION
1	GND
2	GND
3	RF INPUT
4	RF INPUT
5	RF INPUT
6	RF INPUT
7	RF INPUT
8	RF INPUT
9	GND
10	GND
11	GND
12	GND
13	RF OUTPUT
14	RF OUTPUT
15	RF OUTPUT
16	RF OUTPUT
17	RF OUTPUT
18	RF OUTPUT
19	GND
20	GND



Part Number System

CGHV35060MP



Table 1.

Parameter	Value	Units
Upper Frequency ¹	3.5	GHz
Power Output	60	W
Package	MP	-

Note¹: Alpha characters used in frequency code indicate a value greater than 9.9 GHz. See Table 2 for value.

Table 2.

Character Code	Code Value
A	0
B	1
C	2
D	3
E	4
F	5
G	6
H	7
J	8
K	9
Examples:	1A = 10.0 GHz 2H = 27.0 GHz

Product Ordering Information

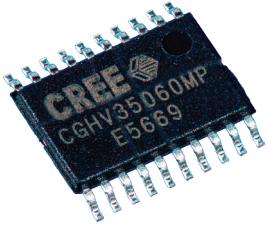
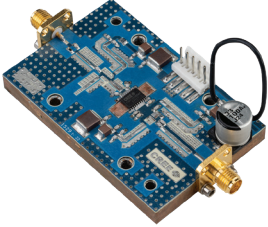
Order Number	Description	Unit of Measure	Image
CGHV35060MP	GaN HEMT	Each	
CGHV35060MP-AMP1	Test board with GaN HEMT installed	Each	



For more information, please contact:

4600 Silicon Drive
Durham, North Carolina, USA 27703
www.wolfspeed.com/rf

Sales Contact
rfsales@cree.com

Notes & Disclaimer

Specifications are subject to change without notice. “Typical” parameters are the average values expected by Cree in large quantities and are provided for information purposes only. Cree products are not warranted or authorized for use as critical components in medical, life-saving, or life-sustaining applications, or other applications where a failure would reasonably be expected to cause severe personal injury or death. No responsibility is assumed by Cree for any infringement of patents or other rights of third parties which may result from use of the information contained herein. No license is granted by implication or otherwise under any patent or patent rights of Cree.

© 2014 – 2021 Cree, Inc. All rights reserved. Wolfspeed® and the Wolfspeed logo are registered trademarks of Cree, Inc.