

FEATURES



Q36SR12020

Quarter Brick DC/DC Power Module

18~75V in, 12V/20A out, 240W

Q36SR12020, Quarter Brick, 18V~75Vin input, single output, isolated DC/DC converters, are the latest offering from a world leader in power systems technology and manufacturing — Delta Electronics, Inc. With creative design technology and optimization of component placement, these converters possess outstanding electrical and thermal performance, as well as extremely high reliability under highly stressful operating conditions. Typical efficiency of the 12V/20A module is greater than 93%.

Electrical

- ♦ High efficiency: 93% @ 12V/20A
- ♦ Industry standard footprint and pin-out
- ♦ Fixed frequency operation
- ♦ OTP, Input UVLO, Output OVP
- ♦ Output OCP Hiccup mode
- ♦ Output voltage trim range: -10%~+10%
- ♦ Monotonic startup into normal and pre-biased loads
- ♦ 2250V isolation and basic insulation
- ♦ No minimum load required
- ♦ No negative current during power or enable on/off

Mechanical

Size:

- ♦ w/o heat-spreader
58.4x36.8x11.7mm (2.30"x1.45"x0.46")
- ♦ with heat-spreader
58.4x36.8x12.7mm (2.30"x1.45"x0.50")

Soldering Methods

- ♦ Wave soldering
- ♦ Hand soldering

Safety & Reliability

- ♦ ISO 9001, TL 9000, ISO 14001, QS 9000, OHSAS18001 certified manufacturing facility
- ♦ UL/cUL 60950-1 (US & Canada)

OPTIONS

- ♦ Negative or positive logic remote On/Off
- ♦ Through hole with heat-spreader

APPLICATIONS

- ♦ Optical Transport
- ♦ Data Networking
- ♦ Communications
- ♦ Servers

(TA=25°C, airflow rate=300 LFM, Vin=48Vdc, nominal Vout unless otherwise noted.)

PARAMETER	NOTES and CONDITIONS	Q36SR12020			Units
		Min.	Typ.	Max.	
ABSOLUTE MAXIMUM RATINGS					
Input Voltage					Vdc
Continuous		0		80	Vdc
Transient (100ms)	100ms			100	Vdc
Operating Ambient Temperature		-40		85	°C
Storage Temperature		-55		125	°C
Input/Output Isolation Voltage				2250	Vdc
INPUT CHARACTERISTICS					
Operating Input Voltage		18	48	75	Vdc
Input Under-Voltage Lockout					
Turn-On Voltage Threshold		16	17	18	Vdc
Turn-Off Voltage Threshold		15	16	17	Vdc
Lockout Hysteresis Voltage		0.3	1	1.8	Vdc
Maximum Input Current	100% Load, 18Vin			17.2	A
No-Load Input Current	Vin=48V, Io=0A		100		mA
Off Converter Input Current	Vin=48V		10		mA
Inrush Current (I2t)				1	A2s
Input Reflected-Ripple Current	P-P thru 12µH inductor, 5Hz to 20MHz		20		mA
Input Voltage Ripple Rejection	120 Hz		50		dB
OUTPUT CHARACTERISTICS					
Output Voltage Set Point	Vin=48V, Io=Io,max, Tc=25°C	11.82	12.00	12.18	Vdc
Output Voltage Regulation					
Load Regulation	Io=Io, min to Io, max		±3	±15	mV
Line Regulation	Vin=18V to 75V		±3	±15	mV
Temperature Regulation	Tc=-40°C to 110°C		±120		mV
Total Output Voltage Range	Over sample load, line and temperature	11.64	12.00	12.36	V
Output Voltage Ripple and Noise	5Hz to 20MHz bandwidth				
Peak-to-Peak	Full Load, 1µF ceramic, 10µF tantalum		100		mV
RMS	Full Load, 1µF ceramic, 10µF tantalum		25		mV
Operating Output Current Range	Vin=18V to 75V	0		20	A
Operating Output Current Range					
DYNAMIC CHARACTERISTICS					
Output Voltage Current Transient	Vin=48V, 10µF Tan & 1µF Ceramic load cap, 0.1A/µs				
Positive Step Change in Output Current	75% Io,max to 50% Io,max		550		mV
Negative Step Change in Output Current	50% Io,max to 75% Io,max		550		mV
Settling Time (within 1% Vout nominal)			200		µs
Turn-On Transient					
Start-Up Time, From On/Off Control			35		mS
Start-Up Time, From Input			35		mS
Output Capacitance (note1)	Full load; 5% overshoot of Vout at startup	0		5000	µF
EFFICIENCY					
100% Load	Vin=24V		93.5		%
100% Load	Vin=48V		93.0		%
60% Load	Vin=48V		92.0		%
ISOLATION CHARACTERISTICS					
Input to Output				2250	Vdc
Isolation Resistance		10			MΩ
Isolation Capacitance			1000		pF
FEATURE CHARACTERISTICS					
Switching Frequency			260		KHz
ON/OFF Control, Negative Remote On/Off logic					
Logic Low (Module On)	Von/off			0.8	V
Logic High (Module Off)	Von/off	2.4		5	V
ON/OFF Control, Positive Remote On/Off logic					
Logic Low (Module Off)	Von/off			0.8	V
Logic High (Module On)	Von/off	2.4		5	V
ON/OFF Current (for both remote on/off logic)	Ion/off at Von/off=0.0V			1	mA
Leakage Current (for both remote on/off logic)	Logic High, Von/off=5V				
Output Voltage Trim Range(note 2)	Pout ≤ max rated power, Io ≤ Io,max	-10		10	%
Output Voltage Remote Sense Range	Pout ≤ max rated power, Io ≤ Io,max			10	%
Output Over-Voltage Protection	Over full temp range; % of nominal Vout	115		140	%
GENERAL SPECIFICATIONS					
MTBF	Io=80% of Io, max; Ta=25°C, normal input, 600FLM		3.0		M hours
Weight	Without heat spreader		45.5		grams
Weight	With heat spreader		61.1		grams
Over-Temperature Shutdown (Without heat spreader)	Refer to Figure 19 for Hot spot 1 location (48Vin, 80% Io, 200LFM, Airflow from Vin+ to Vin-)		135		°C
Over-Temperature Shutdown (With heat spreader)	Refer to Figure 22 for Hot spot 2 location (48Vin, 80% Io, 200LFM, Airflow from Vin+ to Vin-)		120		°C
Over-Temperature Shutdown (NTC resistor)	Refer to Figure 19 for NTC resistor location		130		°C
Note: Please attach thermocouple on NTC resistor to test OTP function, the hot spots' temperature is just for reference.					

Note1: For applications with higher output capacitive load, please contact Delta.

Note2: Trim down range -10% for 18Vin ~75Vin, Trim up range +10% for 20Vin ~ 75Vin.

$T_A=25^{\circ}\text{C}$

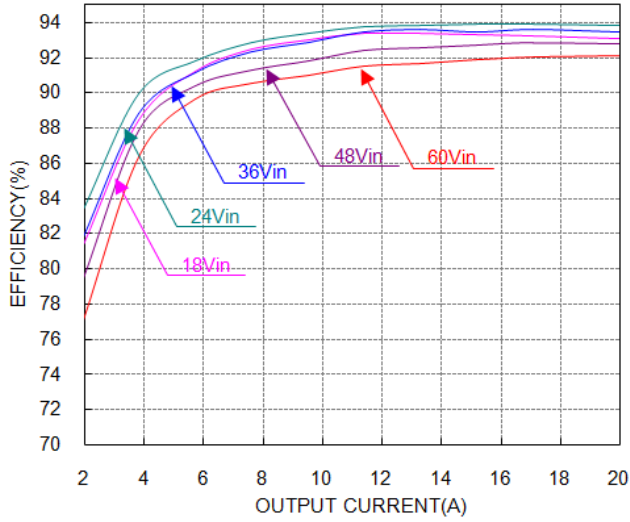

Figure 1: Efficiency vs. load current for minimum, nominal, and maximum input voltage at 25°C

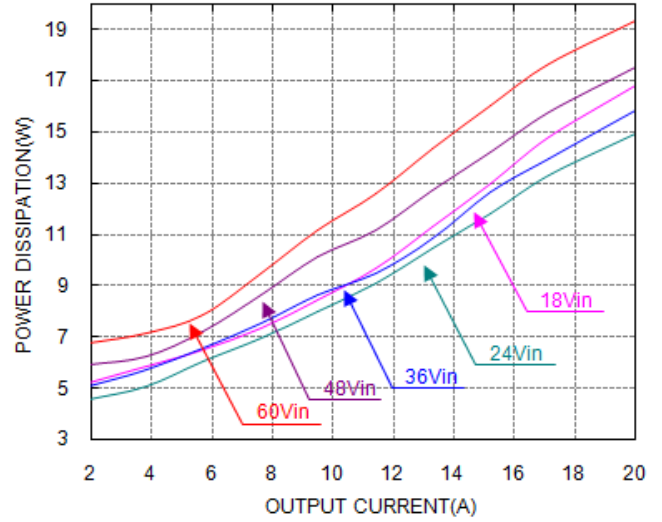

Figure 2: Power dissipation vs. load current for minimum, nominal, and maximum input voltage at 25°C

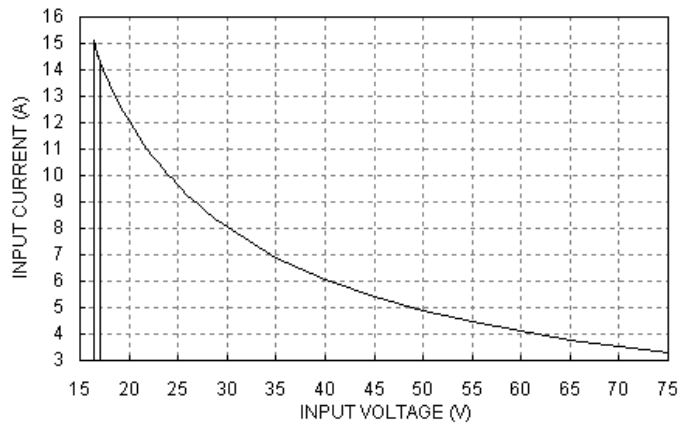

Figure 3: Typical full load input characteristics at room temperature

For Negative Remote On/Off Logic

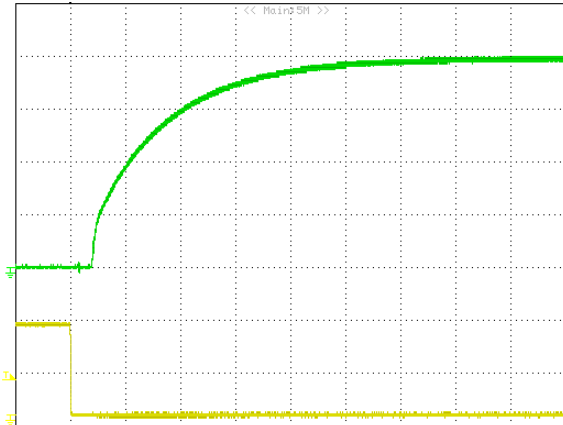

Figure 4: Turn-on transient at full rated load current (resistive load) (10 ms/div). Vin=48V. Top Trace: Vout, 3.0V/div; Bottom Trace: ON/OFF input, 3V/div



Figure 5: Turn-on transient at zero load current (10 ms/div). Vin=48V. Top Trace: Vout: 3.0V/div, Bottom Trace: ON/OFF input, 3V/div

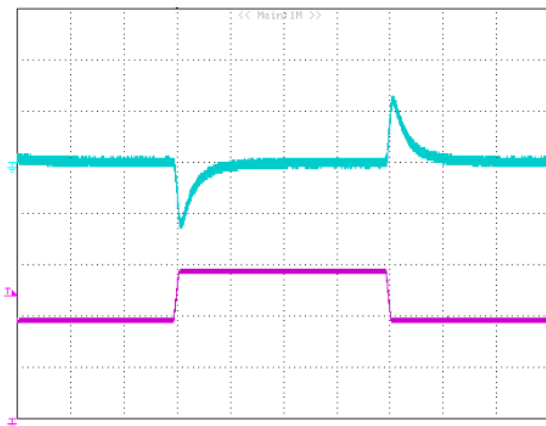

Figure 6: Output voltage response to step-change in load current (50%-75%-50% of Io, max; di/dt = 0.1A/μs; Vin is 24v). Load cap: 10μF tantalum capacitor and 1μF ceramic capacitor. Top Trace: Vout (0.5V/div, 500us/div), Bottom Trace: Iout (5A/div). Scope measurement should be made using a BNC cable (length shorter than 20 inches). Position the load between 51 mm to 76 mm (2 inches to 3 inches) from the module

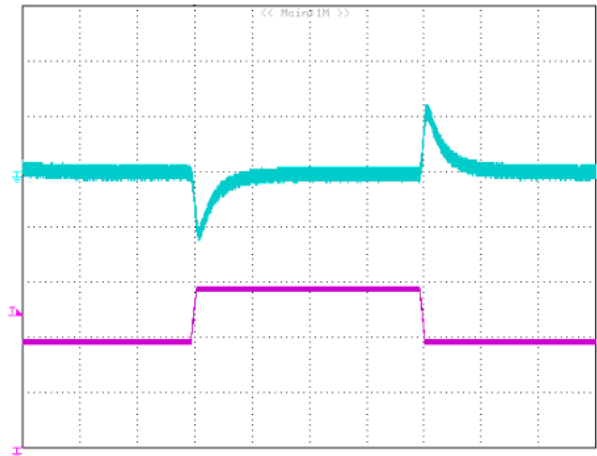

Figure 7: Output voltage response to step-change in load current (50%-75%-50% of Io, max; di/dt = 0.1A/μs; Vin is 48v). Load cap: 10μF tantalum capacitor and 1μF ceramic capacitor. Top Trace: Vout (0.5V/div, 500us/div), Bottom Trace: Iout (5A/div). Scope measurement should be made using a BNC cable (length shorter than 20 inches). Position the load between 51 mm to 76 mm (2 inches to 3 inches) from the module

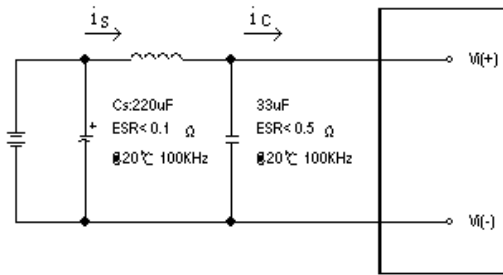

Figure 8: Test set-up diagram showing measurement points for Input Terminal Ripple Current and Input Reflected Ripple Current.

Note: Measured input reflected-ripple current with a simulated source Inductance (LTEST) of 12 µH. Capacitor Cs offset possible battery impedance. Measure current as shown above

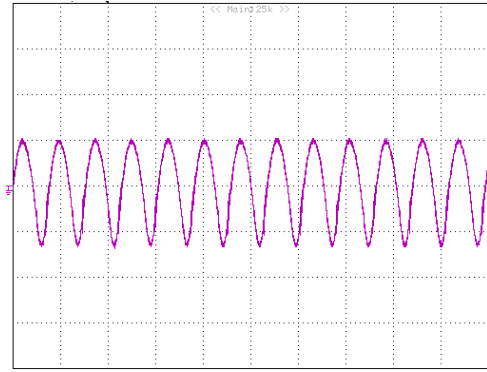

Figure 9: Input Terminal Ripple Current, i_C , at full rated output current and nominal input voltage ($V_{in}=48V$) with 12µH source impedance and 33µF electrolytic capacitor (1A/div, 5µs/div)

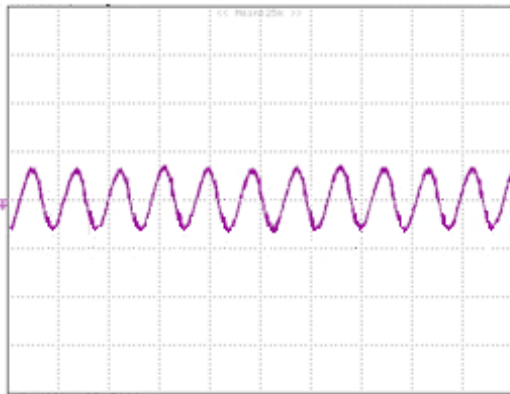

Figure 10: Input reflected ripple current, i_S , through a 12µH source inductor at nominal input voltage ($V_{in}=48V$) and rated load current (20 mA/div, 5µs/div)

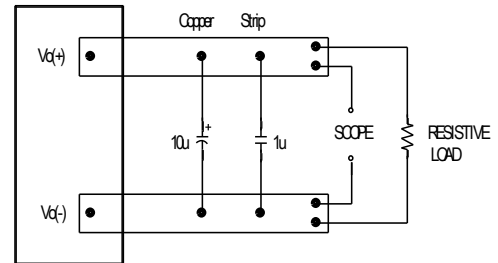

Figure 11: Output voltage noise and ripple measurement test setup

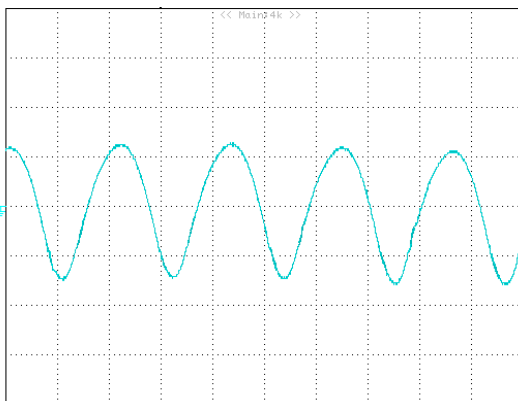

Figure 12: Output voltage ripple at nominal input voltage ($V_{in}=48V$) and rated load current (50 mV/div, 2µs/div). Load capacitance: 1µF ceramic capacitor and 10µF tantalum capacitor. Bandwidth: 20 MHz. Scope measurements should be made using a BNC cable (length shorter than 20 inches). Position the load between 51 mm to 76 mm (2 inches to 3 inches) from the module

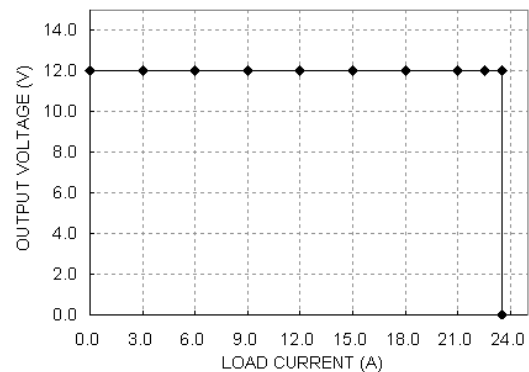

Figure 13: Output Voltage Ripple and Noise at nominal input voltage and max load current (20 mV/div, 2µs/div) Load cap: 1µF ceramic capacitor and 10µF tantalum capacitor. Bandwidth: 20MHz.

Input Source Impedance

The impedance of the input source connecting to the DC/DC power modules will interact with the modules and affect the stability. A low ac-impedance input source is recommended. If the source inductance is more than a few μH , we advise adding a 100 μF electrolytic capacitor (ESR < 0.7 Ω at 100 kHz) mounted close to the input of the module to improve the stability.

Layout and EMC Considerations

Delta's DC/DC power modules are designed to operate in a wide variety of systems and applications. For design assistance with EMC compliance and related PWB layout issues, please contact Delta's technical support team. An external input filter module is available for easier EMC compliance design. Below is the reference design for an input filter tested with Q36SR12020 to meet class A in CISPR 22.

Schematic

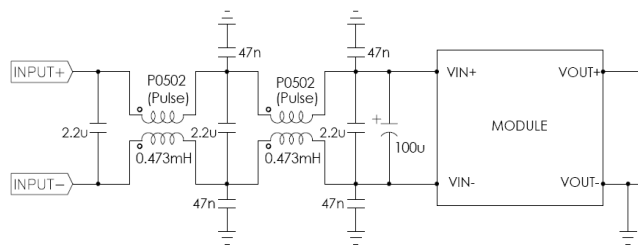

Figure 14-1: Recommended Input Filter

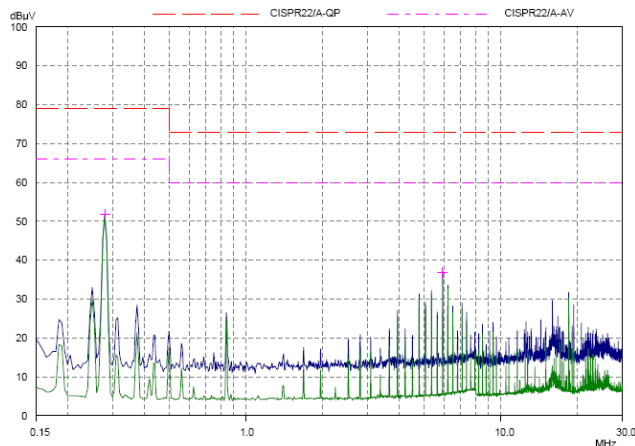

Figure 14-2: Test Result of EMC

25C, 48Vin, full load, Green line is quasi peak mode and blue line is average mode.

Safety Considerations

The power module must be installed in compliance with the spacing and separation requirements of the end-user's safety agency standard, i.e., UL60950-1(2nd Edition), CAN/CSA C22.2 NO. 60950-1-07(2nd Edition) and IEC 60950-1: 2005 (2nd Edition), if the system in which the power module is to be used must meet safety agency requirements.

DESIGN CONSIDERATIONS

Basic insulation based on 75 Vdc input is provided between the input and output of the module for the purpose of applying insulation requirements when the input to this DC-to-DC converter is identified as TNV-2 or SELV. An additional evaluation is needed if the source is other than TNV-2 or SELV.

When the input source is SELV circuit, the power module meets SELV (safety extra-low voltage) requirements. If the input source is a hazardous voltage which is greater than 60 Vdc and less than or equal to 75 Vdc, for the module's output to meet SELV requirements, all of the following must be met:

- The input source must be insulated from the ac mains by reinforced or double insulation.
- The input terminals of the module are not operator accessible.
- A SELV reliability test is conducted on the system where the module is used, in combination with the module, to ensure that under a single fault, hazardous voltage does not appear at the module's output.

When installed into a Class II equipment (without grounding), spacing consideration should be given to the end-use installation, as the spacing between the module and mounting surface have not been evaluated.

The power module has extra-low voltage (ELV) outputs when all inputs are ELV.

This power module is not internally fused. To achieve optimum safety and system protection, an input line fuse is highly recommended. The safety agencies require a Fast-acting fuse with 50A maximum rating to be installed in the ungrounded lead. A lower rated fuse can be used based on the maximum inrush transient energy and maximum input current.

Soldering and Cleaning Considerations

Post solder cleaning is usually the final board assembly process before the board or system undergoes electrical testing. Inadequate cleaning and/or drying may lower the reliability of a power module and severely affect the finished circuit board assembly test. Adequate cleaning and/or drying is especially important for un-encapsulated and/or open frame type power modules. For assistance on appropriate soldering and cleaning procedures, please contact Delta's technical support team.

Over-Current Protection

The modules include an internal output over-current protection circuit, which will endure current limiting for an unlimited duration during output overload. If the output current exceeds the OCP set point, the modules will automatically shut down, and enter hiccup mode.

For hiccup mode, the module will try to restart after shutdown. If the over current condition still exists, the module will shut down again. This restart trial will continue until the over-current condition is corrected.

Over-Voltage Protection

The modules include an internal output over-voltage protection circuit, which monitors the voltage on the output terminals. If this voltage exceeds the over-voltage set point, the module will shut down, and enter in hiccup.

For hiccup mode, the module will try to restart after shutdown. If the over voltage condition still exists, the module will shut down again. This restart trial will continue until the over-voltage condition is corrected.

Over-Temperature Protection

The over-temperature protection consists of circuitry that provides protection from thermal damage. If the temperature exceeds the over-temperature threshold the module will shut down, and enter in hiccup.

For hiccup mode, the module will try to restart after shutdown. This restart trial will continue until the over-temperature condition is corrected.

Remote On/Off

The remote on/off feature on the module can be either negative or positive logic. Negative logic turns the module on during a logic low and off during a logic high. Positive logic turns the modules on during a logic high and off during a logic low.

Remote on/off can be controlled by an external switch between the on/off terminal and the Vi(-) terminal. The switch can be an open collector or open drain.

For negative logic if the remote on/off feature is not used, please short the on/off pin to Vi(-). For positive logic if the remote on/off feature is not used, please leave the on/off pin floating.

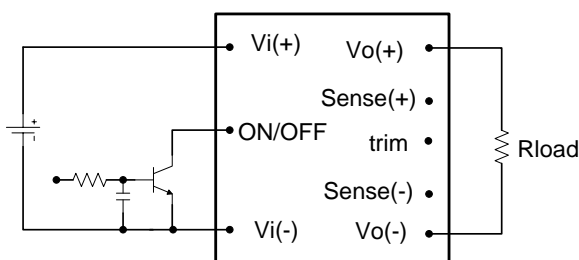

Figure 15: Remote on/off implementation

Remote Sense

Remote sense compensates for voltage drops on the output by sensing the actual output voltage at the point of load. The voltage between the remote sense pins and the output terminals must not exceed the output voltage sense range given here:

$$[Vo(+) - Vo(-)] - [SENSE(+) - SENSE(-)] \leq 10\% \times V_{out}$$

This limit includes any increase in voltage due to remote sense compensation and output voltage set point adjustment (trim).

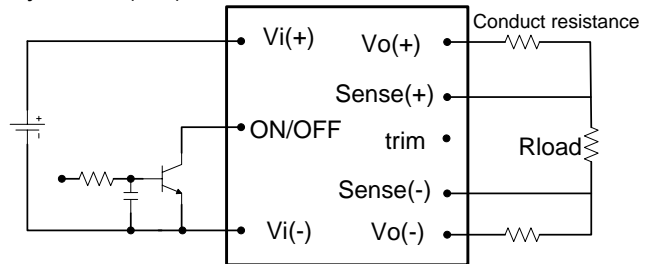

Figure 16: Effective circuit configuration for remote sense operation

If the remote sense feature is not used to regulate the output at the point of load, please connect SENSE(+) to Vo(+) and SENSE(-) to Vo(-) at the module.

The output voltage can be increased by both the remote sense and the trim; however, the maximum increase is the larger of either the remote sense or the trim, not the sum of both.

When using remote sense and trim, the output voltage of the module is usually increased, which increases the power output of the module with the same output current.

Care should be taken to ensure that the maximum output power does not exceed the maximum rated power.

Output Voltage Adjustment (TRIM)

To increase or decrease the output voltage set point, connect an external resistor between the TRIM pin and the SENSE(+) or SENSE(-). The TRIM pin should be left open if this feature is not used.

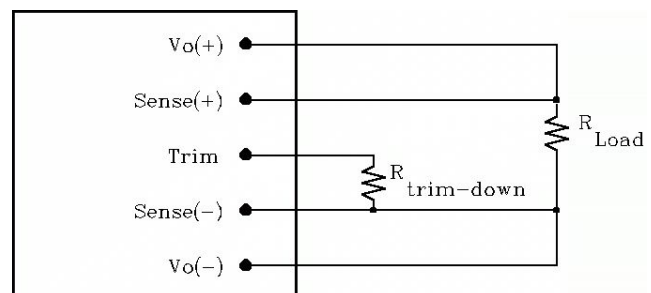

Figure 17: Circuit configuration for trim-down (decrease output voltage)

If the external resistor is connected between the TRIM and SENSE (-) pins, the output voltage set point decreases. The external resistor value required to obtain a percentage of output voltage change $\Delta\%$ is defined as:

$$R_{trim-down} = \left[\frac{511}{\Delta} - 10.2 \right] (K\Omega)$$

Ex. When Trim-down -10% ($12V \times 0.9 = 10.8V$)

$$R_{trim-down} = \left[\frac{511}{10} - 10.2 \right] (K\Omega) = 40.9(K\Omega)$$

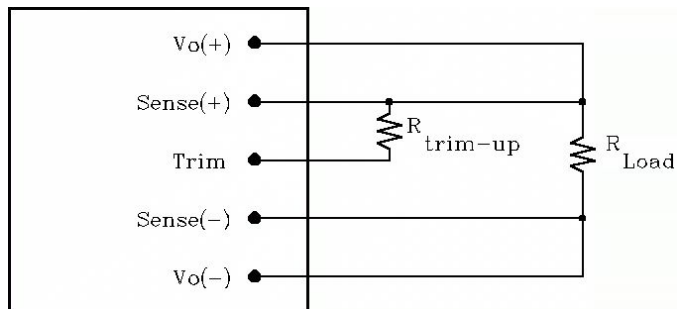

Figure 18: Circuit configuration for trim-up (increase output voltage)

If the external resistor is connected between the TRIM and SENSE (+) the output voltage set point increases. The external resistor value required to obtain a percentage output voltage change $\Delta\%$ is defined as:

$$R_{trim-up} = \frac{5.11 V_o (100 + \Delta)}{1.225 \Delta} - \frac{511}{\Delta} - 10.2 (K\Omega)$$

Ex. When Trim-up +10% ($12V \times 1.1 = 13.2V$)

$$R_{trim-up} = \frac{5.11 \times 12 \times (100 + 10)}{1.225 \times 10} - \frac{511}{10} - 10.2 = 489.3(K\Omega)$$

The output voltage can be increased by both the remote sense and the trim, however the maximum increase is the larger of either the remote sense or the trim, not the sum of both.

When using remote sense and trim, the output voltage of the module is usually increased, which increases the power output of the module with the same output current.

Care should be taken to ensure that the maximum output power of the module remains at or below the maximum rated power.

Thermal management is an important part of the system design. To ensure proper, reliable operation, sufficient cooling of the power module is needed over the entire temperature range of the module. Convection cooling is usually the dominant mode of heat transfer.

Hence, the choice of equipment to characterize the thermal performance of the power module is a wind tunnel.

Thermal Testing Setup

Delta's DC/DC power modules are characterized in heated vertical wind tunnels that simulate the thermal environments encountered in most electronics equipment. This type of equipment commonly uses vertically mounted circuit cards in cabinet racks in which the power modules are mounted.

The following figure shows the wind tunnel characterization setup. The power module is mounted on a 185mmX185mm, 105µm (3Oz), 6 layers' test PWB and is vertically positioned within the wind tunnel. The space between the neighboring PWB and the top of the power module is constantly kept at 6.35mm (0.25").

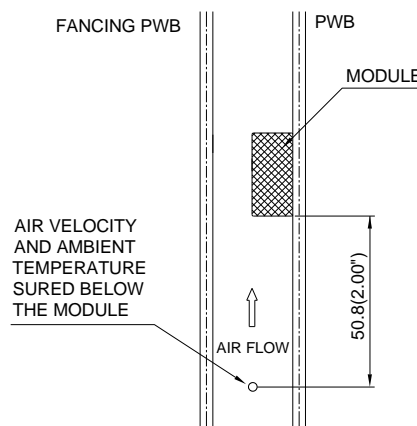

Note: Wind Tunnel Test Setup Figure Dimensions are in millimeters and (Inches)

Figure 19: Wind Tunnel Test Setup

Thermal Derating

Heat can be removed by increasing airflow over the module. To enhance system reliability, the power module should always be operated below the maximum operating temperature. If the temperature exceeds the maximum module temperature, reliability of the unit may be affected.

Thermal Curves (without heat-spreader)

Thermal Curves (without heat-spreader)

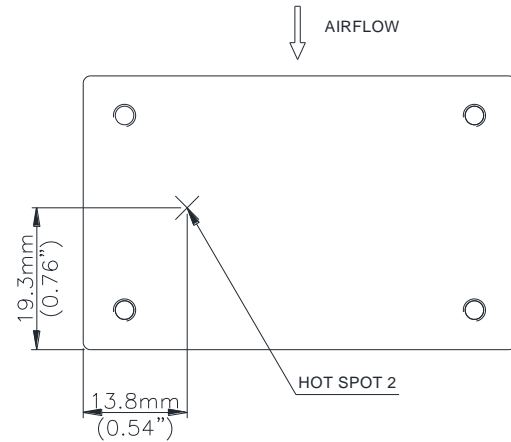
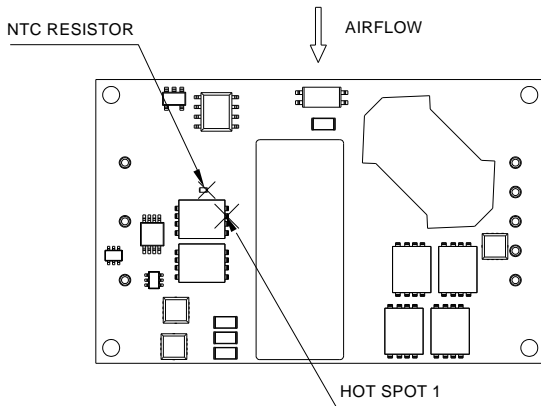

Figure 20: Hot spot1 & NTC resistor temperature measurement locations. The allowed maximum hot spot1 temperature is defined at 120 °C

Figure 23: Hot spot2 temperature measurement location. The allowed maximum hot spot2 temperature is defined at 100 °C

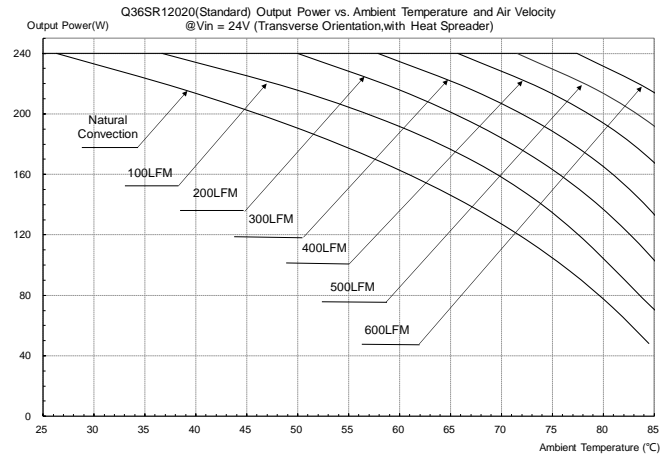
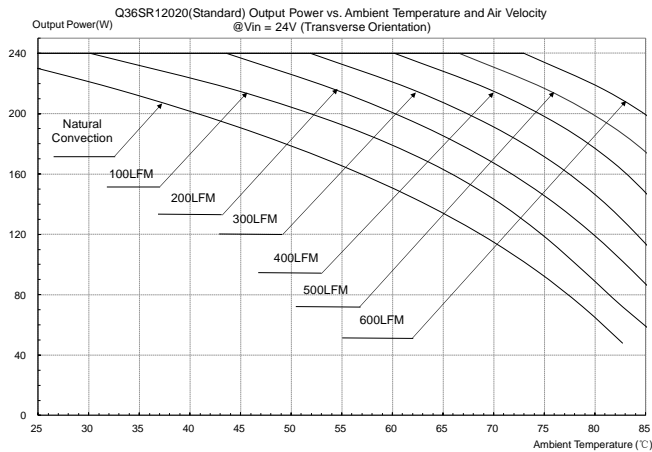

Figure 21: Output current vs. ambient temperature and air velocity @Vin=24V (Transverse Orientation, Airflow direction from Vin+ to Vin-, without heat spreader)

Figure 24: Output current vs. ambient temperature and air velocity @Vin=24V (Transverse Orientation, Airflow direction from Vin+ to Vin-, with heat spreader)

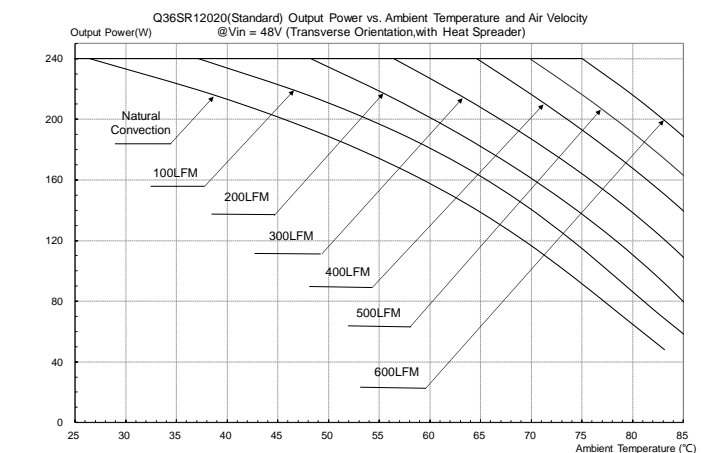
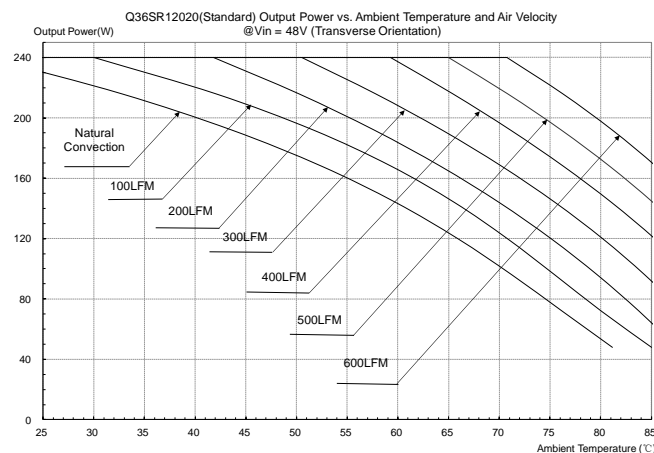
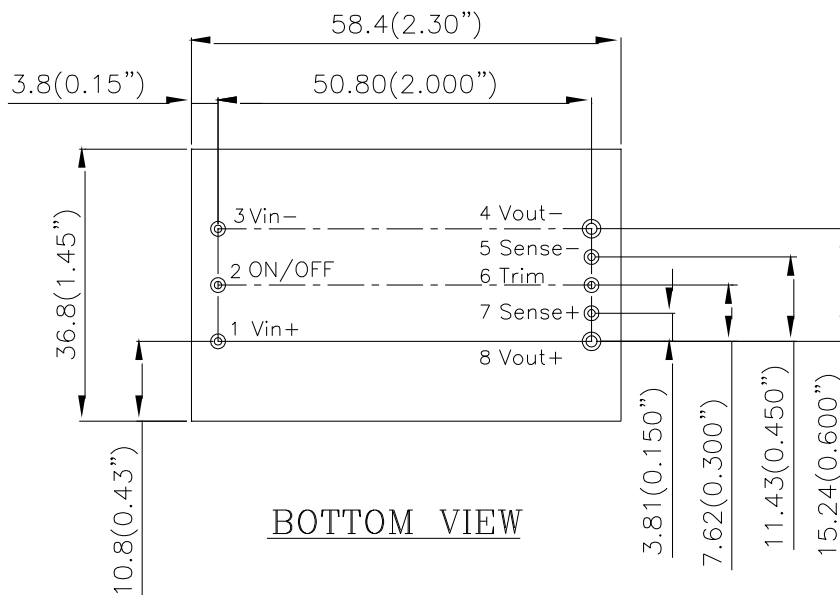
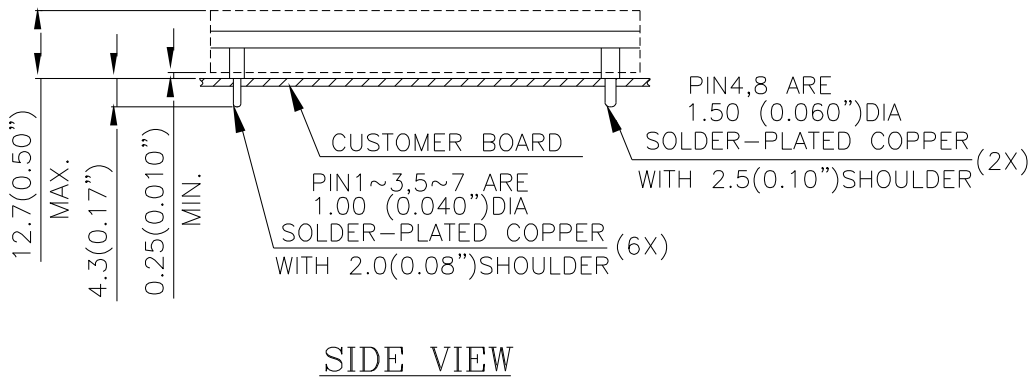
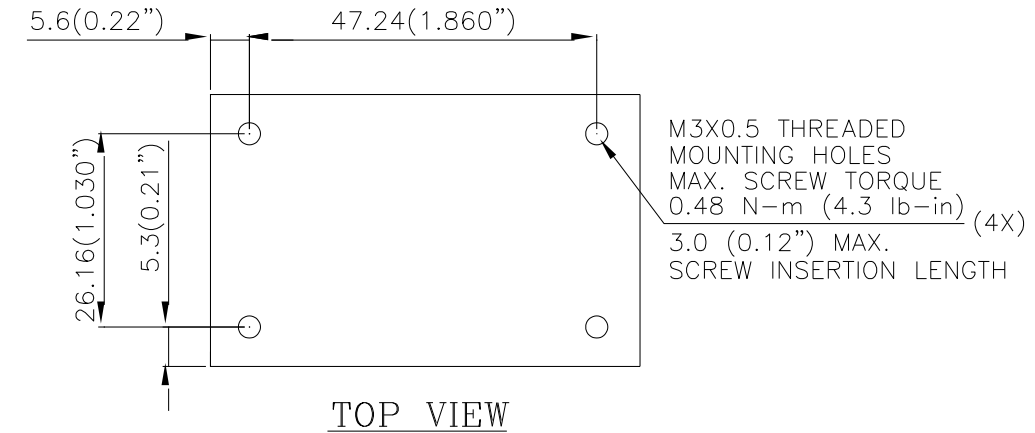

Figure 22: Output current vs. ambient temperature and air velocity @Vin=48V (Transverse Orientation, Airflow direction from Vin+ to Vin-, without heat spreader)

Figure 25: Output current vs. ambient temperature and air velocity @Vin=48V (Transverse Orientation, Airflow direction from Vin+ to Vin-, with heat spreader)

Mechanical Drawing (with heat-spreader)

For modules with through-hole pins and the optional heat-spreader, they are intended for wave soldering assembly onto system boards; please do not subject such modules through reflow temperature profile.

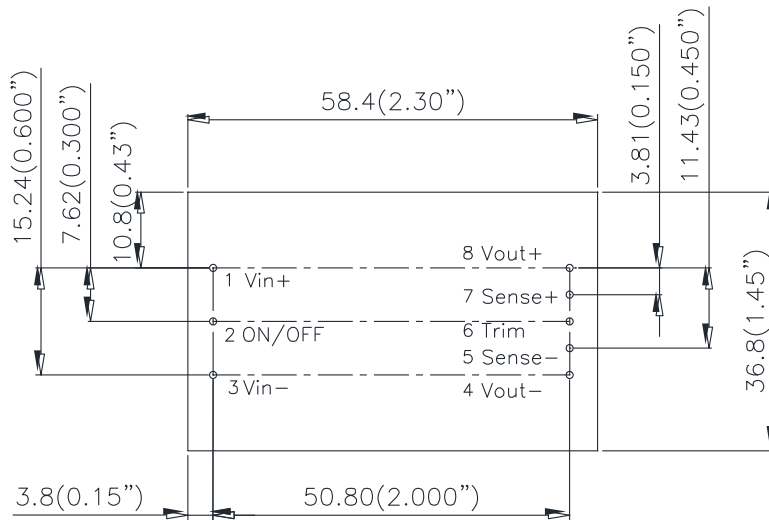
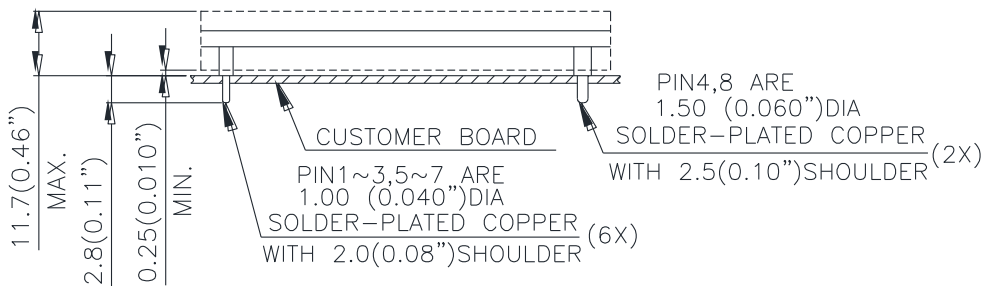

NOTES:
DIMENSIONS ARE IN MILLIMETERS AND (INCHES)
TOLERANCES: X.Xmm±0.5mm(X.XX in.±0.02 in.)
X.XXmm±0.25mm(X.XXX in.±0.010 in.)

Mechanical Drawing (without heat-spreader)

TOP VIEW

SIDE VIEW

NOTES:
 DIMENSIONS ARE IN MILLIMETERS AND (INCHES)
 TOLERANCES: X.Xmm±0.5mm(X.XX in.±0.02 in.)
 X.XXmm±0.25mm(X.XXX in.±0.010 in.)

Pin No.	Name	Function
1	+Vin	Positive input voltage
2	ON/OFF	Remote ON/OFF
3	-Vin	Negative input voltage
4	-Vout	Negative output voltage
5	-Sense	Negative remote sense
6	Trim	Output voltage trim
7	+Sense	Positive remote sense
8	+Vout	Positive output voltage

Pin Specification:

Pins 1-3,5-7 1.00mm (0.040") diameter
 Pins 4 & 8 1.50mm (0.060") diameter
 Note: All pins are copper alloy with matte tin(Pb free) plated over Ni under-plating.

Recommended Pad Layout (Through-hole Module)

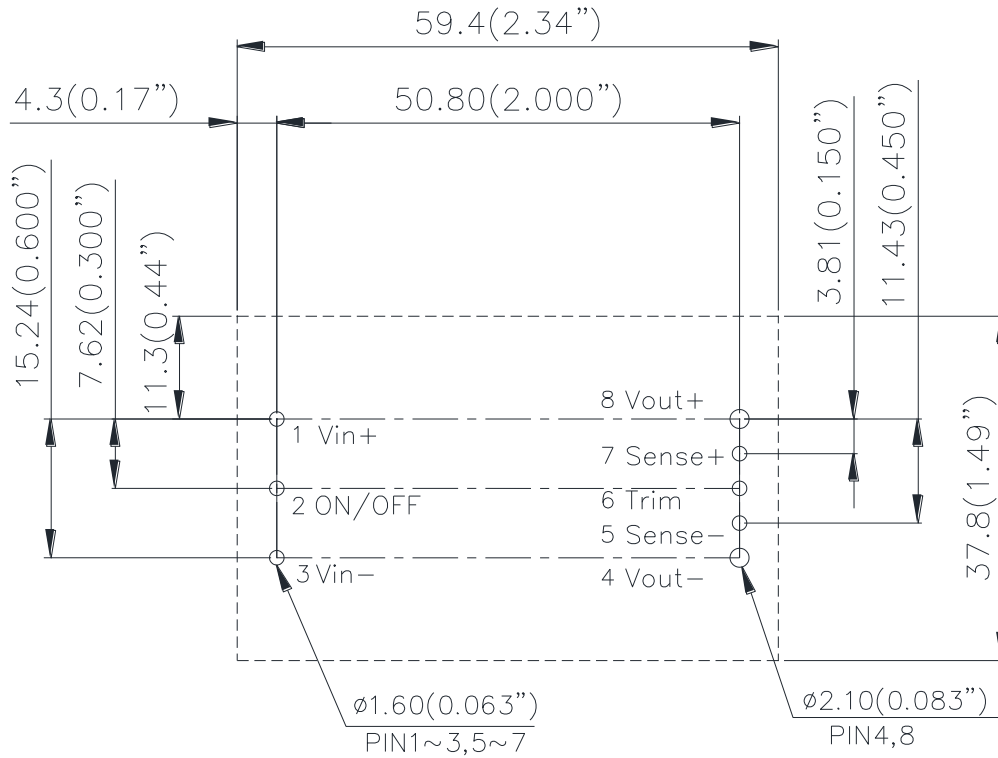

RECOMMENDED P.W.B. PAD LAYOUT

NOTES:
 DIMENSIONS ARE IN MILLIMETERS AND (INCHES)
 TOLERANCES: X.Xmm±0.5mm(X.XX in.±0.02 in.)
 X.XXmm±0.25mm(X.XXX in.±0.010 in.)

Soldering method

Generally, as the most common mass soldering method for the solder attachment, wave soldering is used for through-hole power modules and reflow soldering is used for surface-mount ones. Delta recommended soldering methods and process parameters are provided in this document for solder attachment of power modules onto system board. SAC305 is the suggested lead-free solder alloy for all soldering methods.

Reflow soldering is not a suggested method for through-hole power modules due to many process and reliability concerns. If you have this kind of application requirement, please contact Delta sales or FAE for further confirmation.

Wave Soldering (Lead-free)

Delta's power modules are designed to be compatible with single-wave or dual wave soldering. The suggested soldering process must keep the power module's internal temperature below the critical temperature of 217°C continuously. The recommended wave-soldering profile is shown in following figure.

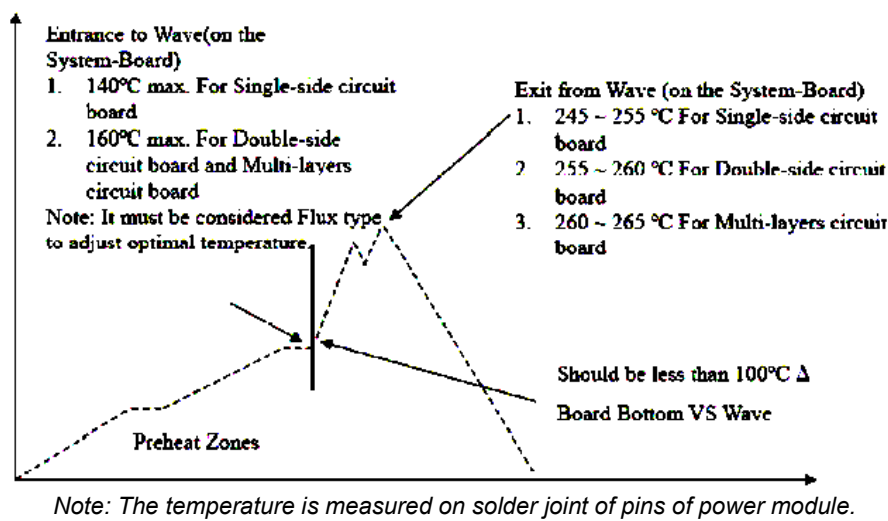

Recommended Temperature Profile for Lead-free Wave Soldering

The typical recommended (for double-side circuit board) preheat temperature is 115+/-10°C on the top side (component side) of the circuit board. The circuit-board bottom-side preheat temperature is typically recommended to be greater than 135°C and preferably within 100 °C of the solder-wave temperature. A maximum recommended preheat up rate is 3°C /s. A maximum recommended solder pot temperature is 255+/-5°C with solder-wave dwell time of 3~6 seconds. The cooling down rate is typically recommended to be 6°C/s maximum.

Hand Soldering (Lead Free)

Hand soldering is the least preferred method because the amount of solder applied, the time the soldering iron is held on the joint, the temperature of the iron, and the temperature of the solder joint are variable. The recommended hand soldering guideline is listed in Table below. The suggested soldering process must keep the power module's internal temperature below the critical temperature of 217°C continuously.

Table Hand-Soldering Guideline

Parameter	Single-side Circuit Board	Double-side Circuit Board	Multi-layers Circuit Board
Soldering Iron Wattage	90	90	90
Tip Temperature	385+/-10°C	420+/-10°C	420+/-10°C
Soldering Time	2 ~ 6 seconds	4 ~ 10 seconds	4 ~ 10 seconds



PART NUMBERING SYSTEM

Q	36	S	R	120	20	N	R	F	A
Form Factor	Input Voltage	Number Of Outputs	Product Series	Output Voltage	Output Current	ON/OFF Logic	Pin Length	RoHS	Option Code
Q - 1/4 Brick	36 - 18V~75V	S - Single	R - Regular	120 - 12V	20- 20A	N - Negative P- Positive	R - 0.170" N - 0.146"	Space - RoHS 5/6 F - RoHS 6/6 (Lead Free)	A – Standard Functions H-with heat spreader

MODEL LIST

Model Name	Input		Output		Eff. @ 100% Load
Q36SR12020NRFA	18V~75V	17.2A	12V	20A	93.0% @ 48Vin
Q36SR12020NRFH	18V~75V	17.2A	12V	20A	93.0% @ 48Vin

Default remote On/Off logic is negative and pin length is 0.170".

For different remote On/Off logic and pin length, please refer to part numbering system above or contact your local sales office.

For modules with through-hole pins and the optional heat-spreader, they are intended for wave soldering assembly onto system boards; please do not subject such modules through reflow temperature profile.

CONTACT US:

Website: www.deltaww.com/dcdc

Email: dcdc@deltaww.com

USA:

Telephone:
East Coast: 978-656-3993
West Coast: 510-668-5100
Fax: (978) 656 3964

Europe:

Telephone: +31-20-655-0967
Fax: +31-20-655-0999

Asia & the rest of world:

Telephone: +886 3 4526107
Ext. 6220~6226
Fax: +886 3 4513485

WARRANTY

Delta offers a two (2) year limited warranty. Complete warranty information is listed on our web site or is available upon request from Delta.

Information furnished by Delta is believed to be accurate and reliable. However, no responsibility is assumed by Delta for its use, nor for any infringements of patents or other rights of third parties, which may result from its use. No license is granted by implication or otherwise under any patent or patent rights of Delta. Delta reserves the right to revise these specifications