

Safety Standard Recognized, C700, Encapsulated, KJN Type, X1 440/760 VAC/Y1 250/400/500 VAC (Industrial Grade)

Overview

KEMET's C700, encapsulated radial leaded ceramic disc capacitors are specifically designed for interference-suppression AC line filtering applications. Having internationally recognized safety certifications, these capacitors are well-suited for applications that require keeping potentially disruptive or damaging line transients and EMI out of susceptible equipment. They are also an ideal solution when needing to suppress line disturbances at the source.

Safety Certified Capacitors are classified as either X and/or Y capacitors. Class X capacitors are primarily used in line-to-line (across-the-line) applications. In this application, there is no danger of electric shock to humans should the

capacitor fail, but could result in a risk of fire. The class Y capacitor is primarily used in line-to-ground (line by-pass) applications. In this application, failure of the capacitor could lead to danger of electric shock.

With a working voltage of 440/760 VAC in line-to-line (Class X) and 250/400/500 VAC in line-to-ground (Class Y) applications, these safety capacitors meet the impulse test criteria outlined in IEC Standard 60384. Meeting subclass X1 and Y1 requirements, these devices are certified to withstand impulses up to 4 KV (X1) and 8 KV (Y1) respectively. These encapsulated devices also meet the flame test requirements outlined in UL Standard 94 V-0.

Benefits

- Safety standard recognized (IEC 60384-14)
- Reliable operation up to 125°C
- Class X1 440/760 VAC/ Y1 250/400/500 VAC
- 10mm and 12.5 mm lead spacing
- Lead(Pb)-free and RoHS Compliant
- Halogen-free
- Capacitance offerings ranging from 8 pF – 4.7 nF
- Available capacitance tolerances of $\pm 5\%$, $\pm 10\%$, and $\pm 20\%$
- High-reliability
- Preformed (crimped) or straight lead configurations
- Non-polar device, minimizing installation concerns
- 100% pure matte tin-plated lead finish, allowing for excellent solderability
- Encapsulation meets flammability standard UL 94 V-0



Applications

Typical applications include:

- Line-to-line (Class X) filtering
- Line-to-ground (Class Y) filtering
- Antenna coupling
- Primary and secondary coupling (switching power supplies)
- Line disturbances suppression (motors and motor controls, relays, switching power supplies and invertors)

Built Into Tomorrow

Ordering Information

C7	7	1	U	472	M	S	W	D	A	A	7301
Ceramic Series	Body Diameter	Lead Spacing ^{1,2}	Spec.	Capacitance Code (pF)	Capacitance Tolerance	Rated Voltage	Dielectric/Temp. Char.	Design	Lead Configuration ²	Failure Rate	Packaging (C-Spec)
C7 = Ceramic 700	2 = 9.0 mm 3 = 10.0 mm 4 = 11.0 mm 5 = 12.0 mm 6 = 13.0 mm 7 = 14.0 mm 8 = 15.0 mm	1 = 10.0 mm 2 = 12.5 mm	U = Safety	Two significant digits and Number of zeroes	J = ±5% K = ±10% M = ±20%	S = X1 440 VAC/ Y1 400 VAC T = X1 440 VAC/ Y1 250 VAC W = X1 760 VAC/ Y1 500 VAC	S = SL Y = Y5P W = Y5U V = Y5V	D = Disc	A = Straight B = Vertical Kink C = Outside Kink D = Inside Kink	A = N/A	See "Packaging C-Spec Ordering Options Table" below

¹ Capacitor body diameter will limit available lead spacing and packaging options. See "Dimensions" and "Product Ordering Codes and Ratings" sections of this document to determine availability.

² Bulk packaging lead length availability is dependent upon "Lead Configuration" and "Lead Spacing." See "Dimensions" section of this document to verify availability of a specific lead length option. For nonstandard lead length inquiries, please contact KEMET.

Packaging C-Spec Ordering Options Table

Packaging Type	Lead Length (mm) ^{2,3}	Packaging Ordering Code (C-Spec)
Reel	See Note 2	7301
Ammo Pack		7317
Bulk Bag	3.5 ±1.0	WL35
	5.0 ±1.0	WL50
	25.0 mm Minimum	WL25

¹ For nonstandard lead length inquiries, please contact KEMET.

² Lead length for ammo and reel pack packaging is defined by the H and H0 dimensions in Table 3.

Lead Configurations

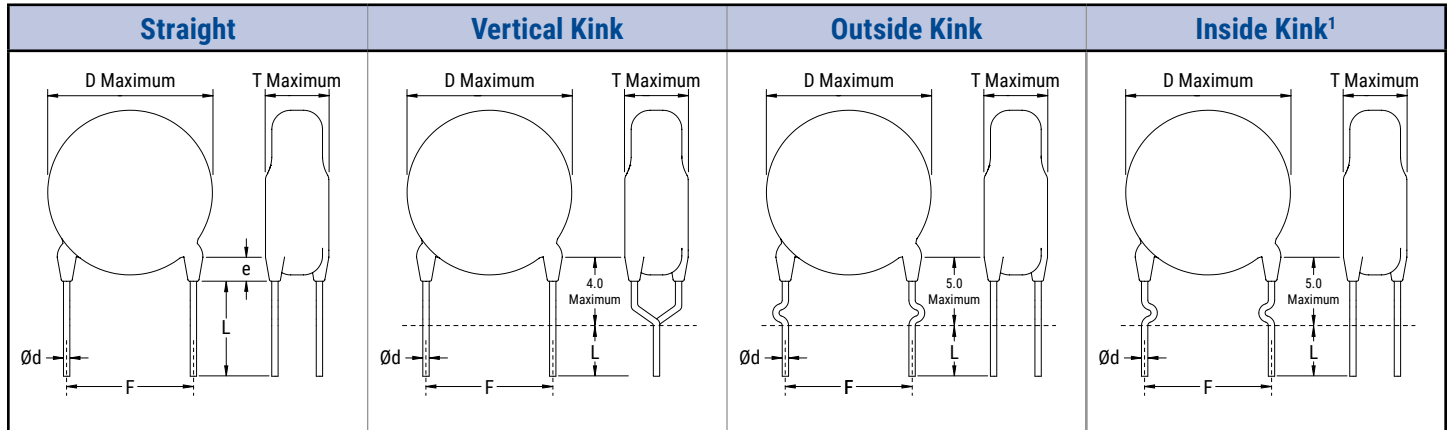

All lead configurations are available on devices with lead spacing of 10 mm and 12.5 mm.

Dimensions – Millimeters

Lead Configuration	Lead Configuration Ordering Code ¹	F	Lead Spacing Tolerance	D	T	e	Ød
		Lead Spacing ²		Body Diameter ²	Body Thickness	Lead Meniscus	Lead Diameter
Straight	A	10, 12.5	±1.0	See Table 1 - "Product Ordering Codes and Ratings"		3.0 maximum	0.60 ±0.1
Vertical Kink (Preformed)	B						
Outside Kink (Preformed)	C						
Inside Kink (Preformed)	D						

¹ Lead Configuration is identified in the 13th character of the ordering code. See "Lead Configuration" and "Ordering Information" sections of this document for further details.

² Body diameter of capacitor will limit available lead spacing and packaging options. See "Product Ordering Codes and Ratings" sections of this document for further details.

Approval Standard and Certification No.

Safety Standard	Standard No.	Subclass	Working Voltage	Certificate No.
TUV	IEC 60384-14	X1	440 VAC	R50466900
		Y1	250 VAC	
TUV	IEC 60384-14	X1	440 VAC	R50466900
		Y1	400 VAC	
TUV	IEC 60384-14	X1	760 VAC	R50466900
		Y1	500 VAC	
UL CAN/CSA	UL 60384-14 and E60384-14	X1	440 VAC	E356389
		Y1	250 VAC	
UL CAN/CSA	UL 60384-14 and E60384-14	X1	440 VAC	E356389
		Y1	400 VAC	
UL CAN/CSA	UL 60384-14 and E60384-14	X1	760 VAC	E356389
		Y1	500 VAC	

These devices are TUV and UL recognized for antenna coupling and AC line-to-line (Class X) and line-to-ground (Class Y) applications per IEC60384-14 and UL 60384-14.

Environmental Compliance

These devices are Halogen-free and RoHS Compliant. They meet all requirements set forth by both EU and China RoHS directives.



Table 1A – Product Ordering Codes and Ratings - X1 440 Y1 400

Dielectric/ Temp. Char.	KEMET Part Number	Capacitance	Capacitance Tolerance	Dimensions (mm)			Lead Spacing
				Body Diameter (Maximum)	Body Thickness (Maximum)	Lead Diameter	
SL	C72(1)U080JSSD(2)A(3)	8 pF	±5%	9.0	6.0	0.60 ± 0.1	10.0 mm 12.5 mm
	C72(1)U100JSSD(2)A(3)	10 pF					
	C72(1)U150JSSD(2)A(3)	15 pF					
	C72(1)U220JSSD(2)A(3)	22 pF					
	C73(1)U330JSSD(2)A(3)	33 pF		10.0			
	C73(1)U390JSSD(2)A(3)	39 pF					
	C74(1)U470JSSD(2)A(3)	47 pF					
	C74(1)U560JSSD(2)A(3)	56 pF					
C75(1)U680JSSD(2)A(3)	68 pF	11.0					
SL	C72(1)U080KSSD(2)A(3)	8 pF	±10%	9.0	6.0	0.60 ± 0.1	10.0 mm 12.5 mm
	C72(1)U100KSSD(2)A(3)	10 pF					
	C72(1)U150KSSD(2)A(3)	15 pF					
	C72(1)U220KSSD(2)A(3)	22 pF					
	C73(1)U330KSSD(2)A(3)	33 pF		10.0			
	C73(1)U390KSSD(2)A(3)	39 pF					
	C74(1)U470KSSD(2)A(3)	47 pF					
	C74(1)U560KSSD(2)A(3)	56 pF					
C75(1)U680KSSD(2)A(3)	68 pF	11.0					
Y5P	C72(1)U080KSYD(2)A(3)	8 pF	±10%	9.0	6.0	0.60 ± 0.1	10.0 mm 12.5 mm
	C72(1)U100KSYD(2)A(3)	10 pF					
	C72(1)U150KSYD(2)A(3)	15 pF					
	C72(1)U220KSYD(2)A(3)	22 pF					
	C72(1)U330KSYD(2)A(3)	33 pF					
	C72(1)U390KSYD(2)A(3)	39 pF					
	C72(1)U470KSYD(2)A(3)	47 pF					
	C72(1)U560KSYD(2)A(3)	56 pF					
	C72(1)U680KSYD(2)A(3)	68 pF					
	C72(1)U101KSYD(2)A(3)	100 pF					
	C72(1)U151KSYD(2)A(3)	150 pF					
	C72(1)U181KSYD(2)A(3)	180 pF					
	C72(1)U221KSYD(2)A(3)	220 pF					
	C72(1)U331KSYD(2)A(3)	330 pF					
	C72(1)U361KSYD(2)A(3)	360 pF					
	C72(1)U391KSYD(2)A(3)	390 pF					
	C72(1)U421KSYD(2)A(3)	420 pF					
	C72(1)U471KSYD(2)A(3)	470 pF					
	C73(1)U561KSYD(2)A(3)	560 pF					
	C73(1)U681KSYD(2)A(3)	680 pF					
C75(1)U102KSYD(2)A(3)	1000 pF	10.0					
Y5U	C72(1)U102MSWD(2)A(3)	1000 pF	±20%	9.0	6.0	0.60 ± 0.1	10.0 mm 12.5 mm
	C74(1)U152MSWD(2)A(3)	1500 pF					
	C75(1)U222MSWD(2)A(3)	2200 pF					
	C77(1)U332MSWD(2)A(3)	3300 pF					
	C78(1)U392MSWD(2)A(3)	3900 pF					
	C78(1)U472MSWD(2)A(3)	4700 pF					
	C78(1)U472MSWD(2)A(3)	4700 pF					
Y5V	C72(1)U102MSVD(2)A(3)	1000 pF	±20%	9.0	6.0	0.60 ± 0.1	10.0 mm 12.5 mm
	C72(1)U152MSVD(2)A(3)	1500 pF					
	C73(1)U222MSVD(2)A(3)	2200 pF					
	C75(1)U332MSVD(2)A(3)	3300 pF					
	C76(1)U392MSVD(2)A(3)	3900 pF					
	C77(1)U472MSVD(2)A(3)	4700 pF					
	C77(1)U472MSVD(2)A(3)	4700 pF					

(1) To properly complete ordering code, insert the one-digit numeric code to reflect required lead spacing: (Note that select capacitance values and packaging options may limit lead spacing availability. See table above to verify availability.)

1 = 10.0 mm

2 = 12.5 mm

(2) To properly complete ordering code, insert the one-digit character code to reflect the required lead configuration: (See "Lead Configuration" section of this document, page 2, for further details.)

A = Straight

B = Vertical Kink

C = Outside Kink

D = Inside Kink

(3) To properly complete ordering code, enter the four-digit numeric or alphanumeric "Packaging C-Spec Ordering Code." See "Dimensions" section of this document, page 2, for available options.

Table 1B – Product Ordering Codes and Ratings - X1 440 Y1 250

Dielectric/ Temp. Char.	KEMET Part Number	Capacitance	Capacitance Tolerance	Dimensions (mm)			Lead Spacing
				Body Diameter (Maximum)	Body Thickness (Maximum)	Lead Diameter	
SL	C72(1)U080JTS(2)A(3)	8 pF	±5%	9.0			
	C72(1)U100JTS(2)A(3)	10 pF					
	C72(1)U150JTS(2)A(3)	15 pF					
	C72(1)U220JTS(2)A(3)	22 pF					
	C73(1)U330JTS(2)A(3)	33 pF		10.0			
	C73(1)U390JTS(2)A(3)	39 pF					
	C74(1)U470JTS(2)A(3)	47 pF					
	C74(1)U560JTS(2)A(3)	56 pF					
C75(1)U680JTS(2)A(3)	68 pF	12.0					
SL	C72(1)U080KTS(2)A(3)	8 pF	±10%	9.0			
	C72(1)U100KTS(2)A(3)	10 pF					
	C72(1)U150KTS(2)A(3)	15 pF					
	C72(1)U220KTS(2)A(3)	22 pF					
	C73(1)U330KTS(2)A(3)	33 pF		10.0			
	C73(1)U390KTS(2)A(3)	39 pF					
	C74(1)U470KTS(2)A(3)	47 pF					
	C74(1)U560KTS(2)A(3)	56 pF					
C75(1)U680KTS(2)A(3)	68 pF	12.0					
Y5P	C72(1)U080KTYD(2)A(3)	8 pF	±10%	9.0	6.0	0.60 ± 0.1	10.0 mm 12.5 mm
	C72(1)U100KTYD(2)A(3)	10 pF					
	C72(1)U150KTYD(2)A(3)	15 pF					
	C72(1)U220KTYD(2)A(3)	22 pF					
	C72(1)U330KTYD(2)A(3)	33 pF					
	C72(1)U390KTYD(2)A(3)	39 pF					
	C72(1)U470KTYD(2)A(3)	47 pF					
	C72(1)U560KTYD(2)A(3)	56 pF					
	C72(1)U680KTYD(2)A(3)	68 pF					
	C72(1)U101KTYD(2)A(3)	100 pF					
	C72(1)U151KTYD(2)A(3)	150 pF					
	C72(1)U181KTYD(2)A(3)	180 pF					
	C72(1)U221KTYD(2)A(3)	220 pF					
	C72(1)U331KTYD(2)A(3)	330 pF					
	C72(1)U361KTYD(2)A(3)	360 pF					
	C72(1)U391KTYD(2)A(3)	390 pF					
	C72(1)U421KTYD(2)A(3)	420 pF					
	C72(1)U471KTYD(2)A(3)	470 pF					
	C73(1)U561KTYD(2)A(3)	560 pF					
	C73(1)U681KTYD(2)A(3)	680 pF					
C75(1)U102KTYD(2)A(3)	1000 pF	10.0					
Y5U	C72(1)U102MTWD(2)A(3)	1000 pF	±20%	9.0			
	C74(1)U152MTWD(2)A(3)	1500 pF		11.0			
	C75(1)U222MTWD(2)A(3)	2200 pF		12.0			
	C77(1)U332MTWD(2)A(3)	3300 pF		14.0			
	C78(1)U392MTWD(2)A(3)	3900 pF		15.0			
	C78(1)U472MTWD(2)A(3)	4700 pF		15.0			
	Y5V	C72(1)U102MTVD(2)A(3)		1000 pF			
C72(1)U152MTVD(2)A(3)		1500 pF	9.0				
C73(1)U222MTVD(2)A(3)		2200 pF	10.0				
C75(1)U332MTVD(2)A(3)		3300 pF	12.0				
C76(1)U392MTVD(2)A(3)		3900 pF	13.0				
C77(1)U472MTVD(2)A(3)		4700 pF	14.0				
Dielectric/ Temp. Char.	KEMET Part Number	Capacitance	Capacitance Tolerance	Body Diameter (Maximum)	Body Thickness (Maximum)	Lead Diameter	Lead Spacing

(1) To properly complete ordering code, insert the one-digit numeric code to reflect required lead spacing: (Note that select capacitance values and packaging options may limit lead spacing availability. See table above to verify availability.)

1 = 10.0 mm

2 = 12.5 mm

(2) To properly complete ordering code, insert the one-digit character code to reflect the required lead configuration: (See "Lead Configuration" section of this document, page 2, for further details.)

A = Straight

B = Vertical Kink

C = Outside Kink

D = Inside Kink

(3) To properly complete ordering code, enter the four-digit numeric or alphanumeric "Packaging C-Spec Ordering Code." See "Dimensions" section of this document, page 2, for available options.

Table 1C – Product Ordering Codes and Ratings - X1 760 Y1 500

Dielectric/ Temp. Char.	KEMET Part Number	Capacitance	Capacitance Tolerance	Dimensions (mm)			Lead Spacing
				Body Diameter (Maximum)	Body Thickness (Maximum)	Lead Diameter	
SL	C72(1)U100JWSD(2)A(3)	10 pF	±5%	9.0	6.0	0.60 ± 0.1	10.0 mm 12.5 mm
	C72(1)U150JWSD(2)A(3)	15 pF					
	C72(1)U220JWSD(2)A(3)	22 pF					
	C73(1)U330JWSD(2)A(3)	33 pF					
	C73(1)U390JWSD(2)A(3)	39 pF					
	C74(1)U470JWSD(2)A(3)	47 pF					
	C74(1)U560JWSD(2)A(3)	56 pF	±10%	9.0			
	C75(1)U680JWSD(2)A(3)	68 pF					
	C72(1)U100KWSD(2)A(3)	10 pF					
	C72(1)U150KWSD(2)A(3)	15 pF					
	C72(1)U220KWSD(2)A(3)	22 pF					
	C73(1)U330KWSD(2)A(3)	33 pF					
	C73(1)U390KWSD(2)A(3)	39 pF					
	C74(1)U470KWSD(2)A(3)	47 pF					
	C74(1)U560KWSD(2)A(3)	56 pF					
	C75(1)U680KWSD(2)A(3)	68 pF					
Y5P	C72(1)U100KWYD(2)A(3)	10 pF	±10%	9.0			
	C72(1)U150KWYD(2)A(3)	15 pF					
	C72(1)U220KWYD(2)A(3)	22 pF					
	C72(1)U330KWYD(2)A(3)	33 pF					
	C72(1)U390KWYD(2)A(3)	39 pF					
	C72(1)U470KWYD(2)A(3)	47 pF					
	C72(1)U560KWYD(2)A(3)	56 pF					
	C72(1)U680KWYD(2)A(3)	68 pF					
	C72(1)U101KWYD(2)A(3)	100 pF					
	C72(1)U151KWYD(2)A(3)	150 pF					
	C72(1)U181KWYD(2)A(3)	180 pF					
	C72(1)U221KWYD(2)A(3)	220 pF					
	C72(1)U331KWYD(2)A(3)	330 pF					
	C72(1)U361KWYD(2)A(3)	360 pF					
	C72(1)U391KWYD(2)A(3)	390 pF					
	C72(1)U471KWYD(2)A(3)	470 pF					
	C73(1)U561KWYD(2)A(3)	560 pF					
	C73(1)U681KWYD(2)A(3)	680 pF					
C75(1)U102KWYD(2)A(3)	1000 pF						
Y5U	C72(1)U221MWW(2)A(3)	220 pF	±20%	9.0			
	C72(1)U331MWW(2)A(3)	330 pF					
	C72(1)U471MWW(2)A(3)	470 pF					
	C72(1)U681MWW(2)A(3)	680 pF					
	C72(1)U102MWW(2)A(3)	1000 pF					
	C74(1)U152MWW(2)A(3)	1500 pF					
	C75(1)U222MWW(2)A(3)	2200 pF					
	C75(1)U272MWW(2)A(3)	2700 pF					
	C77(1)U332MWW(2)A(3)	3300 pF					
	C78(1)U392MWW(2)A(3)	3900 pF					
C78(1)U472MWW(2)A(3)	4700 pF						
Dielectric/ Temp. Char.	KEMET Part Number	Capacitance	Capacitance Tolerance	Body Diameter (Maximum)	Body Thickness (Maximum)	Lead Diameter	Lead Spacing

(1) To properly complete ordering code, insert the one-digit numeric code to reflect required lead spacing: (Note that select capacitance values and packaging options may limit lead spacing availability. See table above to verify availability.)

1 = 10.0 mm

2 = 12.5 mm

(2) To properly complete ordering code, insert the one-digit character code to reflect the required lead configuration: (See "Lead Configuration" section of this document, page 2, for further details.)

A = Straight

B = Vertical Kink

C = Outside Kink

D = Inside Kink

(3) To properly complete ordering code, enter the four-digit numeric or alphanumeric "Packaging C-Spec Ordering Code." See "Dimensions" section of this document, page 2, for available options.

Table 2 – Performance & Reliability: Test Methods and Conditions

Item		Specification	Test Method																			
Operating Temperature Range		-40°C to +125°C																				
Dielectric Strength	Between lead wires	No failures	The capacitor shall not be damaged when 4,000 VAC (rms) is applied between the lead wires for 60 seconds.																			
	Body Insulation	No failures	The terminals (leads) of the capacitor shall be connected together. A metal foil is tightly wrapped around the body of the capacitor at a distance of about 3 to 4 mm from each terminal. The capacitor is then inserted into a container filled with metal balls approximately 1 mm in diameter. 4,000 VAC (rms) is applied for 60 seconds between the capacitor lead wires and metal balls. (charge/discharge current ≤ 50 mA)																			
Insulation Resistance (IR)		10,000 MΩ minimum	The insulation resistance shall be measured with 500 ±50 VDC applied after 60 ±5 seconds of charging.																			
Capacitance		Within specified tolerance																				
Dissipation Factor (DF) or Q	<table border="1"> <thead> <tr> <th>Temperature Characteristics</th> <th>Specification</th> </tr> </thead> <tbody> <tr> <td>Y5P</td> <td>DF ≤ 2.5%</td> </tr> <tr> <td>Y5U/Y5V</td> <td>DF ≤ 5.0%</td> </tr> <tr> <td>SL</td> <td>Q ≥ 300</td> </tr> </tbody> </table>		Temperature Characteristics	Specification	Y5P	DF ≤ 2.5%	Y5U/Y5V	DF ≤ 5.0%	SL	Q ≥ 300	<table border="1"> <thead> <tr> <th>Characteristic</th> <th>Frequency</th> <th>Voltage</th> </tr> </thead> <tbody> <tr> <td>SL</td> <td>1 MHz ±20%</td> <td rowspan="2">5.0 V_{rms} Maximum</td> </tr> <tr> <td>Y5P /Y5U/Y5V</td> <td>1 MHz ±20%</td> </tr> <tr> <td colspan="3">The measurement at reference temperature 25°C</td> </tr> </tbody> </table>	Characteristic	Frequency	Voltage	SL	1 MHz ±20%	5.0 V _{rms} Maximum	Y5P /Y5U/Y5V	1 MHz ±20%	The measurement at reference temperature 25°C		
	Temperature Characteristics	Specification																				
	Y5P	DF ≤ 2.5%																				
	Y5U/Y5V	DF ≤ 5.0%																				
SL	Q ≥ 300																					
Characteristic	Frequency	Voltage																				
SL	1 MHz ±20%	5.0 V _{rms} Maximum																				
Y5P /Y5U/Y5V	1 MHz ±20%																					
The measurement at reference temperature 25°C																						
Temperature Characteristics	<table border="1"> <thead> <tr> <th>Temperature Characteristics</th> <th>Capacitance Change</th> </tr> </thead> <tbody> <tr> <td>Y5P</td> <td>Within ±10%</td> </tr> <tr> <td>Y5U</td> <td>Within +22%/-56%</td> </tr> <tr> <td>Y5V</td> <td>Within +22%/-82%</td> </tr> <tr> <td>SL</td> <td>+350~1,000%</td> </tr> </tbody> </table>		Temperature Characteristics	Capacitance Change	Y5P	Within ±10%	Y5U	Within +22%/-56%	Y5V	Within +22%/-82%	SL	+350~1,000%	A capacitance measurement is made at each step specified:									
	Temperature Characteristics	Capacitance Change																				
	Y5P	Within ±10%																				
	Y5U	Within +22%/-56%																				
	Y5V	Within +22%/-82%																				
SL	+350~1,000%																					
		<table border="1"> <thead> <tr> <th>Step</th> <th>Temperature</th> </tr> </thead> <tbody> <tr> <td>1</td> <td>+25 ±2°C</td> </tr> <tr> <td>2</td> <td>Minimum operating temperature</td> </tr> <tr> <td>3</td> <td>+25 ±2°C</td> </tr> <tr> <td>4</td> <td>Maximum operating temperature</td> </tr> <tr> <td>5</td> <td>+25 ±2°C</td> </tr> </tbody> </table>	Step	Temperature	1	+25 ±2°C	2	Minimum operating temperature	3	+25 ±2°C	4	Maximum operating temperature	5	+25 ±2°C								
Step	Temperature																					
1	+25 ±2°C																					
2	Minimum operating temperature																					
3	+25 ±2°C																					
4	Maximum operating temperature																					
5	+25 ±2°C																					
			Pretreatment: Capacitor is stored at 85 ±2°C for 1 hour and then placed at room condition ¹ for 24 ±2 hours before measurement.																			
Terminal Strength	Tensile	Lead wire or capacitor body shall not break.	With the termination in its normal position, the specimen is held by its body in such a manner that the axis of the termination is vertical. A tensile force of 10 N is applied to the termination in the direction of its axis and acting in a direction away from the body of the specimen.																			
	Bending	Lead wire or capacitor body shall not break.	With the termination in its normal position, the specimen is held by its body in such a manner that the axis of the termination is vertical; a mass force of 5 N is then suspended from the end of the termination. The body of the specimen is then inclined within a period of 2 to 3 seconds, through an angle of approximately 90° in the vertical plane and then resumed to its initial position over the same period of time; this operation constitutes one bend. One bend immediately followed by a second bend in the opposite direction.																			

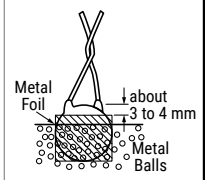

¹ "Room Condition" is defined as follows: Temperature: 20 ~ 35°C/Humidity: 45 ~ 75%/Atmospheric Pressure: 86 ~ 106 kPa.

Table 2 – Performance & Reliability: Test Methods and Conditions cont.

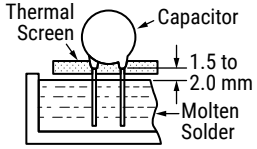
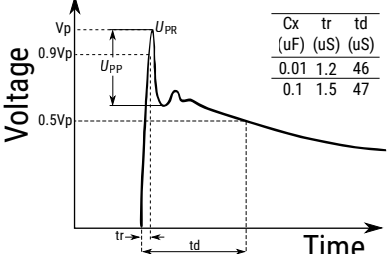
Item		Specification	Test Method												
Soldering Effect (Non-Preheat)	Appearance	No visual defect	<p>As shown in the figure below, the lead wires are immersed in molten solder up to 1.5 mm (+5/-0 mm) from the end of the epoxy meniscus (root of lead wire). Duration/Solder Temperature: 3.5 ±0.5 seconds/350°C ±10°C or 10 ±1 seconds/260°C ±5°C</p>  <p>Pretreatment: Capacitor is stored at 85°C ±2°C for 1 hour and then placed at room condition¹ for 24 ±2 hours before initial measurements. Post-treatment: Capacitor is stored for 1 to 2 hours at room condition¹.</p>												
	IR	1,000 MΩ Minimum													
	Dielectric Strength	Per item 1													
	Capacitance	Within ±10% Y5P, Y5U and Y5V: within ±10% SL: within ±2.5% or ±0.25 pF, whichever is larger													
Biased Humidity	Appearance	No visual defect	Steady State Humidity:	Load Humidity:											
	Capacitance	<table border="1"> <thead> <tr> <th>Temperature Characteristics</th> <th>Capacitance Change</th> </tr> </thead> <tbody> <tr> <td>Y5P</td> <td>Within ±10%</td> </tr> <tr> <td>Y5U</td> <td>Within ±15%</td> </tr> <tr> <td>Y5V</td> <td>Within ±30%</td> </tr> <tr> <td>SL</td> <td>Within ±5%</td> </tr> </tbody> </table>		Temperature Characteristics	Capacitance Change	Y5P	Within ±10%	Y5U	Within ±15%	Y5V	Within ±30%	SL	Within ±5%	90 to 95% humidity at 40°C ±2°C for 500 ±12 hours. Post-treatment: Capacitor is stored for 1 to 2 hours at room condition ¹ .	90 to 95% humidity at 40°C ±2°C for 500 ±12 hours with full rated voltage applied. Post-treatment: Capacitor is stored for 1 to 2 hours at room condition ¹ .
		Temperature Characteristics	Capacitance Change												
		Y5P	Within ±10%												
		Y5U	Within ±15%												
	Y5V	Within ±30%													
	SL	Within ±5%													
	DF	Y5V and Y5U: 7.5% maximum Y5P: 5% maximum													
Q	Q ≥ 135														
IR	3,000 MΩ minimum														
Dielectric Strength	No failures														
High Temperature Life	Appearance	No visual defect	<p>Impulse Voltage: Each individual capacitor is subjected to three 8 kv impulse prior to life testing.</p>  <table border="1"> <thead> <tr> <th>Cx (uF)</th> <th>tr (uS)</th> <th>td (uS)</th> </tr> </thead> <tbody> <tr> <td>0.01</td> <td>1.2</td> <td>46</td> </tr> <tr> <td>0.1</td> <td>1.5</td> <td>47</td> </tr> </tbody> </table> <p>Capacitors are placed in a circulating air oven for a period of 1,000 hours. The air in the oven is maintained at a temperature of 125°C ±2 throughout the test. The capacitors are subjected to 170% of Rated Voltage. Each hour the voltage is increased to AC 1,000 V_{rms} for 0.1 seconds.</p>		Cx (uF)	tr (uS)	td (uS)	0.01	1.2	46	0.1	1.5	47		
	Cx (uF)	tr (uS)			td (uS)										
	0.01	1.2			46										
	0.1	1.5			47										
Capacitance Change	SL, Y5P, Y5U within ±20% Y5V within ±30%														
IR	3,000 MΩ minimum														
Dielectric Strength	No failures														

¹ "Room Condition" is defined as follows: Temperature: 20 ~ 35°C/Humidity: 45 ~ 75%/Atmospheric Pressure: 86 ~ 106 kPa.

Table 2 – Performance & Reliability: Test Methods and Conditions cont.

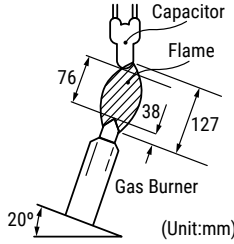
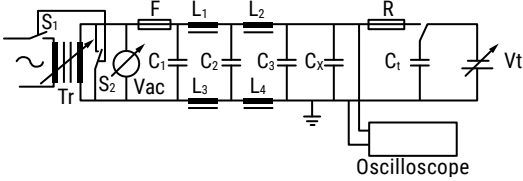
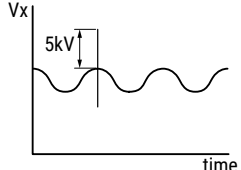
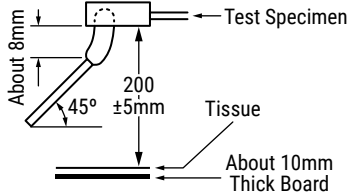
Item	Specification	Test Method																				
<p>Flame Test</p>	<p>The capacitor flame extinguishes as follows:</p> <table border="1" data-bbox="456 447 805 636"> <thead> <tr> <th>Cycle</th> <th>Time</th> </tr> </thead> <tbody> <tr> <td>1 ~ 4</td> <td>30 seconds maximum</td> </tr> <tr> <td>5</td> <td>60 seconds maximum</td> </tr> </tbody> </table>	Cycle	Time	1 ~ 4	30 seconds maximum	5	60 seconds maximum	<p>The capacitor is exposed to a flame for 15 seconds and then removed for 15 seconds. This test is repeated for 5 cycles.</p> 														
Cycle	Time																					
1 ~ 4	30 seconds maximum																					
5	60 seconds maximum																					
<p>Active Flammability</p>	<p>The cheesecloth should not ignite.</p>	<p>The capacitors are individually wrapped in at least one, but not more than two, complete layers of cheesecloth. They are then subjected to 20 discharges. The interval between successive discharges is 5 seconds. The VAC is maintained for 2 minutes after the last discharge.</p>  <table border="1" data-bbox="850 997 1520 1192"> <tbody> <tr> <td>C_{1,2}</td> <td>1 μF ±10%</td> <td>C₃</td> <td>0.033 μF ±5% 10 kV</td> </tr> <tr> <td>L₁₋₁₀</td> <td>1.5 mH ±20% 16 A Rod core choke</td> <td>C_x</td> <td>Test capacitor</td> </tr> <tr> <td>R</td> <td>100 ±2% Ω</td> <td>V_{AC}</td> <td>V_R ±5%</td> </tr> <tr> <td>C_t</td> <td>3 μF ±5% 10 kV</td> <td>V_R</td> <td>Rated Working Voltage</td> </tr> <tr> <td>F</td> <td>Fuse, Rated 10A</td> <td>V_t</td> <td>Voltage applied to C_t</td> </tr> </tbody> </table> 	C _{1,2}	1 μF ±10%	C ₃	0.033 μF ±5% 10 kV	L ₁₋₁₀	1.5 mH ±20% 16 A Rod core choke	C _x	Test capacitor	R	100 ±2% Ω	V _{AC}	V _R ±5%	C _t	3 μF ±5% 10 kV	V _R	Rated Working Voltage	F	Fuse, Rated 10A	V _t	Voltage applied to C _t
C _{1,2}	1 μF ±10%	C ₃	0.033 μF ±5% 10 kV																			
L ₁₋₁₀	1.5 mH ±20% 16 A Rod core choke	C _x	Test capacitor																			
R	100 ±2% Ω	V _{AC}	V _R ±5%																			
C _t	3 μF ±5% 10 kV	V _R	Rated Working Voltage																			
F	Fuse, Rated 10A	V _t	Voltage applied to C _t																			
<p>Passive Flammability</p>	<p>The burning time should not exceed 30 seconds. The tissue paper should not ignite.</p>	<p>The capacitor under test is held into a flame and in a position which best promotes burning. Each specimen is exposed to the flame once.</p>  <p>Time of Exposure to Flame: 30 seconds Length of Flame: 12 ±1 mm Gas Burner Length: 35 mm minimum Inside Diameter: 0.5 ±0.1 mm Outside Diameter: 0.9 mm maximum Gas Butane Gas Purity: 95% minimum</p>																				

¹ "Room Condition" is defined as follows: Temperature: 20 ~ 35°C/Humidity: 45 ~ 75%/Atmospheric Pressure: 86 ~ 106 kPa.

Soldering and Mounting Information

Soldering:

When soldering this product to a PCB/PWB, do not exceed the solder heat resistance specification of the capacitor. Subjecting this product to excessive heating could reflow the solder joint between the lead and ceramic element and/or may result in thermal shocks that can crack the ceramic element.

When soldering these capacitors with a soldering iron, it should be performed under the following conditions:

- Temperature of iron-tip: 400°C maximum
- Soldering iron wattage: 50 W maximum
- Soldering time: 3.5 seconds maximum

Cleaning (ultrasonic cleaning):

To perform ultrasonic cleaning, observe the following conditions:

- Rinse bath capacity: output of 20 watts per liter or less
- Rinsing time: 5 minute maximum
- Do not vibrate the PCB/PWB directly
- Excessive ultrasonic cleaning may lead to fatigue destruction of the lead wires

Construction

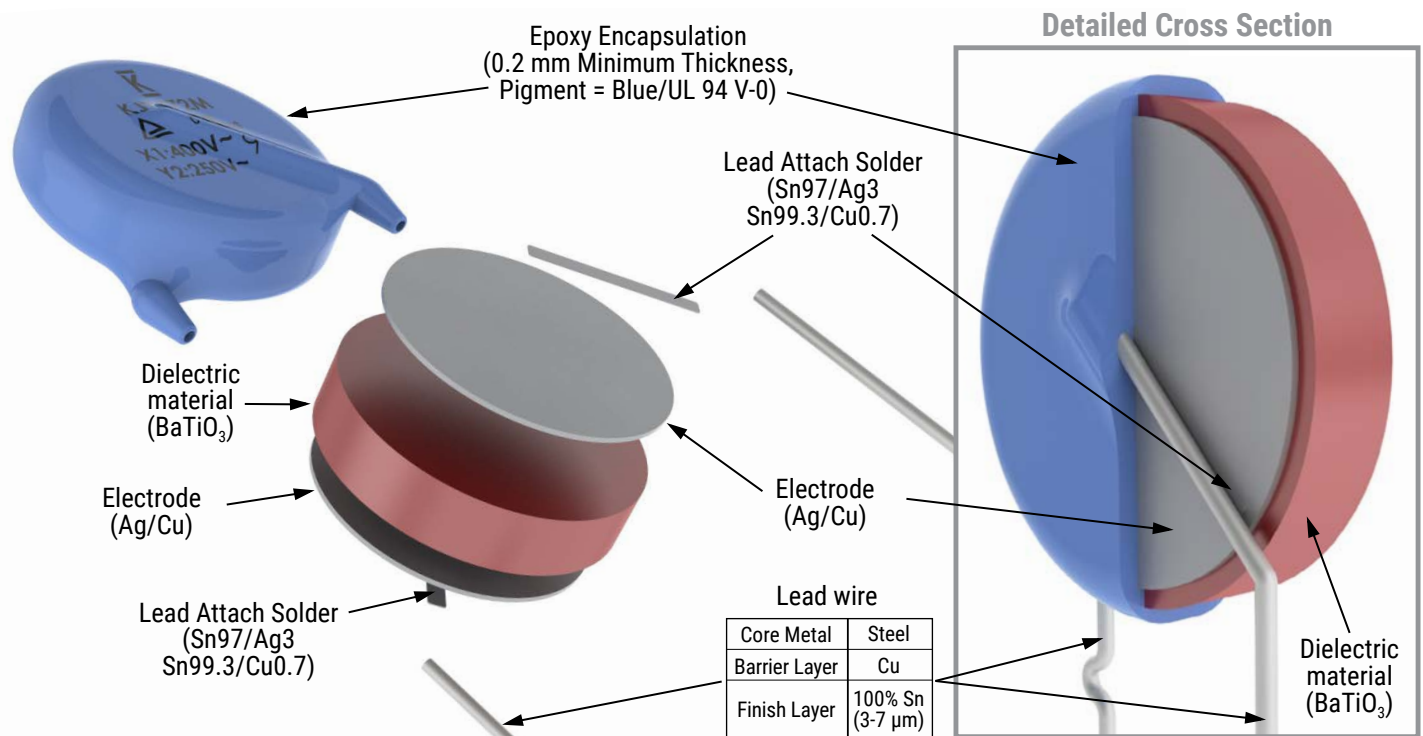

Marking

These capacitors shall be laser marked with KEMET's trademark, type designation, capacitor class, rated voltage, rated capacitance, and capacitance tolerance codes. In addition, all devices are marked with the recognized approval mark and a date/lot code for traceability. Marking will be supplied on one side of the encapsulated capacitor body. All marking shall be legible to allow for clear identification of the component. Marking appears in legible contrast. Illustrated below is an example of the marking format and content.

X1 440 VAC / Y1 250 VAC

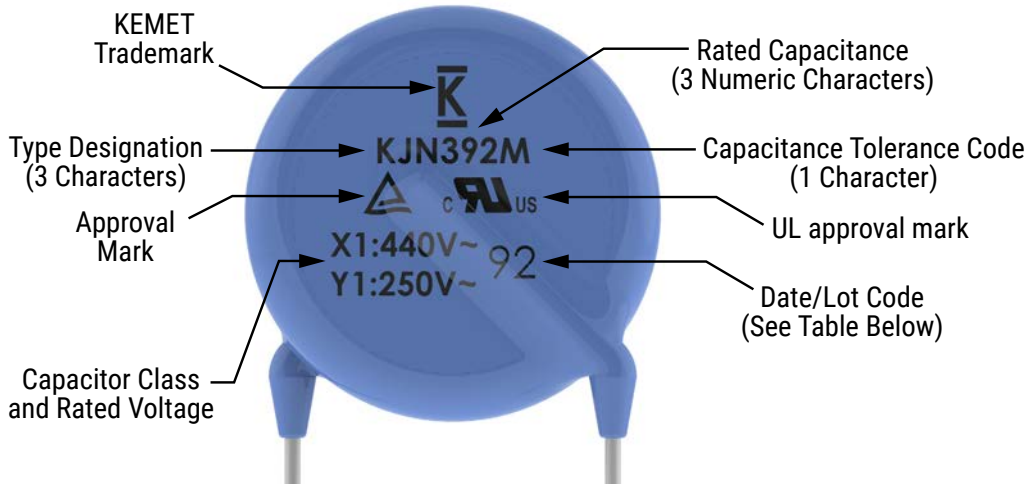

X1 440 VAC / Y1 400 VAC

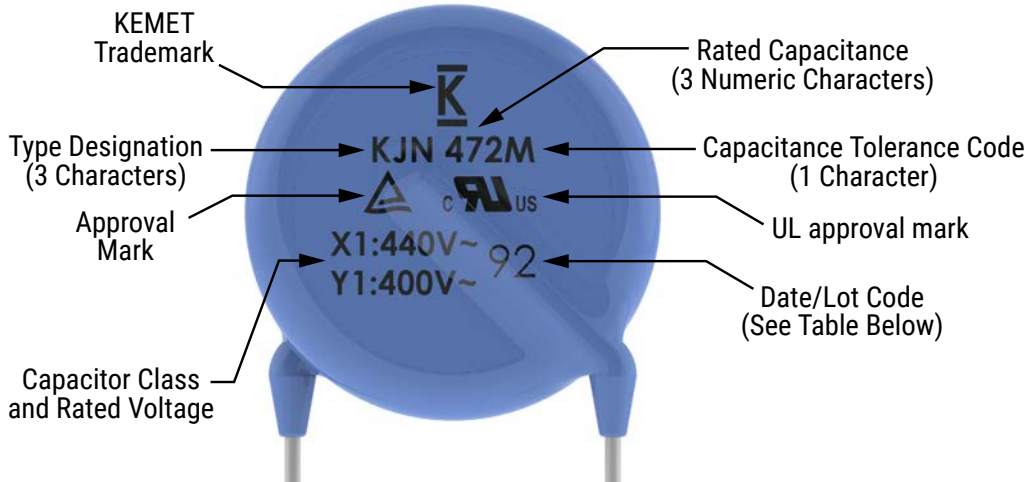

Date/Lot Code e.g., 9D (December 2019, Taiwan)

9	D	-
Last digit of year, e.g., 3 = 2013	Manufacturing Month: 1-9 = Jan - Sept O = October N = November D = December	Manufacturing Location Code (blank): Taiwan C: Dongguan

Marking cont.

X1 760 VAC / Y1 500 VAC

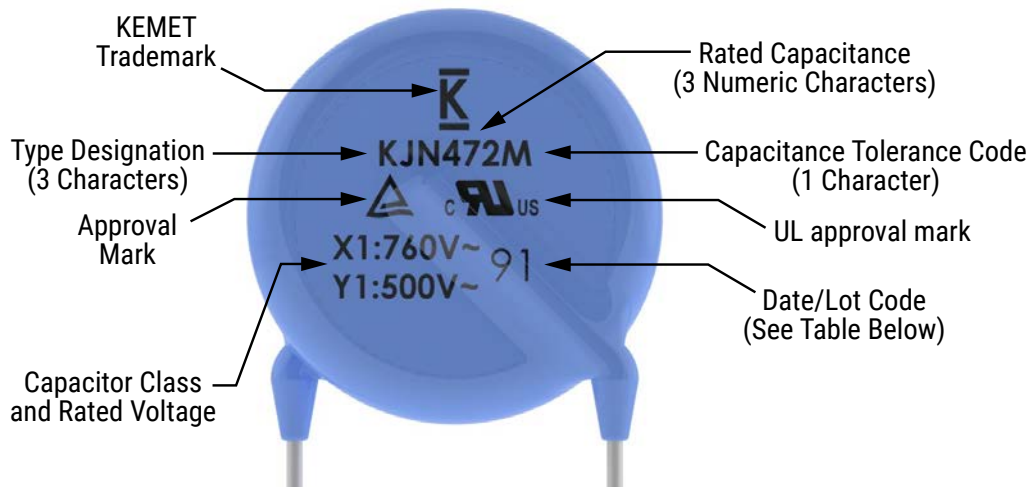

Date/Lot Code e.g., 9D (December 2019, Taiwan)

9	D	-
Last digit of year, e.g., 3 = 2013	Manufacturing Month: 1-9 = Jan - Sept O = October N = November D = December	Manufacturing Location Code (blank): Taiwan C: Dongguan

Packaging Quantities

Capacitor Body Diameter (mm)	Body Diameter Code ¹	Bulk Bag (Loose)	
		Lead Length (WL25)	Cut Lead Length (WL35, WL50, WL10)
7.0	0	200 pieces/bag	500 pieces/bag
8.0	1		
9.0	2		
10.0	3		
11.0	4		
12.0	5		
13.0	6		
14.0	7		
15.0	8		
16.0	9		

¹ The "Body Diameter Code" is located in the third character position of the ordering code. This code identifies the maximum diameter of the capacitor body in millimeters. For more information regarding the ordering code, see "Ordering Information" section of this document.

Lead Spacing	Body Diameter (mm)	Pitch (Carrier Tape)	Body Diameter Code	Reel (7301)	Ammo Pack (7317)
5	≤ 12.0	12.7	0 - 5	2,000 pieces/reel	1,000 pieces/box
	12.0 < D ≤ 16.0	25.4	6 - 9	1,000 pieces/reel	750 pieces/box
7.5	≤ 12.0	12.7	0 - 5	2,000 pieces/reel	1,000 pieces/box
	12.0 < D ≤ 15.0	25.4	6 - 8	1,000 pieces/reel	750 pieces/box
	≥ 16.0		9	750 pieces/reel	750 pieces/box
10	≤ 10	25.4	0 - 3	1,000 pieces/reel	1,000 pieces/box
	≥ 11		4 - 9	750 pieces/reel	750 pieces/box
12.5	≤ 9	25.4	0 - 2	1,000 pieces/reel	500 pieces/box
	≥ 10		3 - 9	500 pieces/reel	500 pieces/box

Figure 1 - Ammo/Reel Pack Taping Format

5 mm and 7.5 mm Lead Spacing:

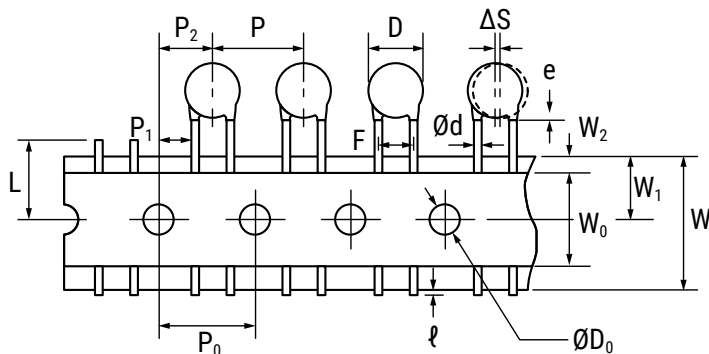

For All Lead Spacing:

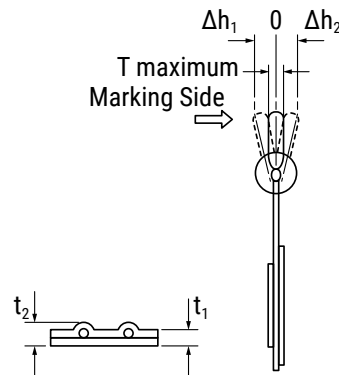

5 mm, 7.5 mm, 10 mm and 12.5 mm Lead Spacing:

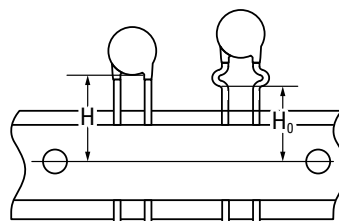
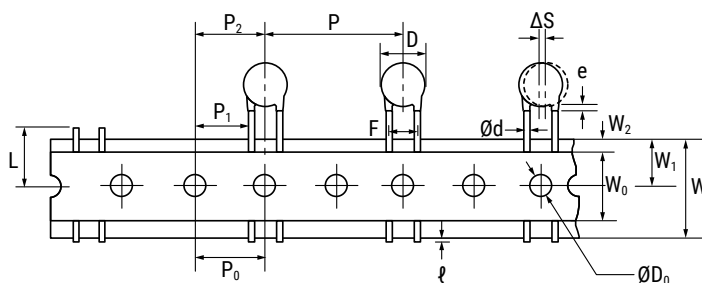

Table 3 – Ammo/Reel Pack Taping Specifications

Lead Spacing		5 mm				7.5 mm				10 mm		12.5 mm	
Lead Style		Straight		Preformed ¹		Straight		Preformed ¹		Straight	Preformed ¹	Straight	Preformed ¹
Item	Symbol	Dimensions (mm)											
Lead Spacing	F	5.0 ±1.0				7.5 ±1.0				10.0 ±1.0		12.5 ±1.0	
Component Pitch	P	12.7 ±1.0	25.4 ±2.0	12.7 ±1.0	25.4 ±2.0	12.7 ±1.0	25.4 ±2.0	12.7 ±1.0	25.4 ±2.0	25.4 ±2.0		25.4 ±2.0	
Sprocket Hole Pitch	P ₀	12.7 ±0.3				12.7 ±0.3				12.7 ±0.3		12.7 ±0.3	
Sprocket Hole Center to Component Center	P ₂	6.35 ±1.5	12.7 ±1.5	6.35 ±1.5	12.7 ±1.5	6.35 ±1.5	12.7 ±1.5	6.35 ±1.5	12.7 ±1.5	12.7 ±1.5		12.7 ±1.5	
Sprocket Hole Center to Lead Center	P ₁	3.85 ±0.7	10.2 ±1.5	3.85 ±0.7	10.2 ±1.5	2.6 ±0.7	8.95 ±1.5	2.6 ±0.7	8.95 ±1.5	7.7 ±1.5		6.45 ±1.5	
Body Diameter	D	See "Product Ordering Codes and Ratings" section of this document.											
Component Alignment (side/side)	ΔS	0 ±2.0											
Carrier Tape Width	W	18.0 +1.0/-0.5											
Sprocket Hole Position	W ₁	9.0 ±0.5											

¹ Preformed (crimped) lead configurations include vertical kink, outside kink, and inside kink. See "Lead Configurations" and "Ordering Information" sections of this document for further details.

² Also referred to as "lead length" in this document.

Table 3 – Ammo Pack Taping Specifications cont.

Lead Spacing		5 mm		7.5 mm		10 mm		12.5 mm	
Lead Style		Straight	Preformed ¹	Straight	Preformed ¹	Straight	Preformed ¹	Straight	Preformed ¹
Item	Symbol	Dimensions (mm)							
Height to Seating Plane ² (preformed leads ¹)	H ₀	N/A	16.0 +2.0/-0	N/A	16.0 +2.0/-0	N/A	16.0 +2.0/-0	N/A	16.0 +2.0/-0
Height to Seating Plane ² (straight leads)	H	20.0 +1.5/-1.0	N/A	20.0 +1.5/-1.0	N/A	20.0 +1.5/-1.0	N/A	20.0 +1.5/-1.0	N/A
Lead Protrusion	ℓ	2.0 maximum							
Diameter of Sprocket Hole	D ₀	4.0 ±0.2							
Lead Diameter	φd	0.6 ±0.1							
Carrier Tape Thickness	t ₁	0.6 ±0.3							
Total Thickness (Carrier Tape, Hold-Down Tape and Lead)	t ₂	1.5 maximum							
Component Alignment (front/back)	Δh ₁	2.0 maximum							
	Δh ₂								
Cut Out Length	L	11.0 maximum							
Hold-Down Tape Width	W ₀	10.0 minimum							
Hold-Down Tape Position	W ₂	3.0 maximum							
Coating Extension on Leads (meniscus)	e	3.0 maximum for straight lead; not to exceed the bend for preformed ¹ lead configurations.							
Body Thickness	T	8.0 maximum							

¹ Preformed (crimped) lead configurations include vertical kink, outside kink, and inside kink. See "Lead Configurations" and "Ordering Information" sections of this document for further details.

² Also referred to as "lead length" in this document.

Application Notes:

Storage and Operating Conditions:

The Insulating coating of these devices does not form an air and moisture tight seal. Avoid exposure to moisture and do not use or store these devices in a corrosive atmosphere, especially where chloride gas, sulfide gas, acid, alkali, salt or the like are present. Before cleaning, bonding or molding these devices, it is important to verify that your process does not affect product quality and performance. KEMET recommends testing and evaluating the performance of a cleaned, bonded or molded product prior to implementing and/or qualifying any of these processes. Store the capacitors where the temperature and relative humidity do not exceed 40 degrees centigrade and 70% respectively. For optimum solderability, capacitor stock should be used promptly, preferably within 6 months of receipt.

Working Voltage:

Application voltage (V_{p-p} or V_{o-p}) must not exceed the voltage rating of the capacitor. Irregular voltages can be generated for a transient period of time when voltage is initially applied and/or removed from a circuit. It is important to choose a capacitor with a voltage rating greater than or equal to these irregular voltages.

Application Notes (cont.):

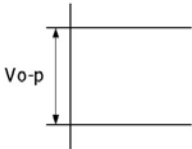
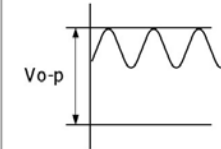
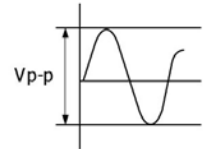
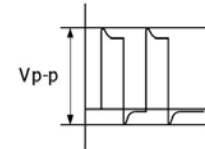
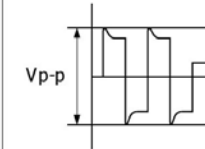
Voltage	DC Voltage	DC+AC Voltage	AC Voltage	Pulse Voltage (1)	Pulse Voltage (2)
Positional Measurement					

Operating Temperature and Self-Generating Heat:

The surface temperature of a capacitor should be kept below the upper limit of its rated operating temperature range. Be sure to take into account the heat generated by the capacitor itself. When the capacitor is used in a high-frequency current, pulse current or similar current, it may self-generate heat due to dielectric loss. Temperature rise due to self-generated heating should not exceed 20°C (while operated at an atmosphere temperature of 25°C).

Handling - Vibration and Impact:

Do not expose these devices or their leads to excessive shock or vibration during use.

FAILURE TO FOLLOW THE ABOVE CAUTIONS MAY RESULT, WORST CASE, IN A SHORT CIRCUIT AND CAUSE FUMING OR PARTIAL DISPERSION WHEN THE PRODUCT IS USED.

KEMET Electronics Corporation Sales Offices

For a complete list of our global sales offices, please visit www.kemet.com/sales.

Disclaimer

All product specifications, statements, information and data (collectively, the "Information") in this datasheet are subject to change. The customer is responsible for checking and verifying the extent to which the Information contained in this publication is applicable to an order at the time the order is placed. All Information given herein is believed to be accurate and reliable, but it is presented without guarantee, warranty, or responsibility of any kind, expressed or implied.

Statements of suitability for certain applications are based on KEMET Electronics Corporation's ("KEMET") knowledge of typical operating conditions for such applications, but are not intended to constitute – and KEMET specifically disclaims – any warranty concerning suitability for a specific customer application or use. The Information is intended for use only by customers who have the requisite experience and capability to determine the correct products for their application. Any technical advice inferred from this Information or otherwise provided by KEMET with reference to the use of KEMET's products is given gratis, and KEMET assumes no obligation or liability for the advice given or results obtained.

Although KEMET designs and manufactures its products to the most stringent quality and safety standards, given the current state of the art, isolated component failures may still occur. Accordingly, customer applications which require a high degree of reliability or safety should employ suitable designs or other safeguards (such as installation of protective circuitry or redundancies) in order to ensure that the failure of an electrical component does not result in a risk of personal injury or property damage.

Although all product-related warnings, cautions and notes must be observed, the customer should not assume that all safety measures are indicated or that other measures may not be required.

KEMET is a registered trademark of KEMET Electronics Corporation.