

# BK PRECISION®

**Model** 1685B, 1687B, 1688B

## Switching DC Power Supply

INSTRUCTION MANUAL





# 1 Safety Summary

The following safety precautions apply to both operating and maintenance personnel and must be observed during all phases of operation, service, and repair of this instrument. Before applying power, follow the installation instructions and become familiar with the operating instructions for this instrument.

## ***GROUND THE INSTRUMENT***

To minimize shock hazard, the instrument chassis and cabinet must be connected to an electrical ground. This instrument is grounded through the ground conductor of the supplied, three-conductor ac power cable. The power cable must be plugged into an approved three-conductor electrical outlet. Do not alter the ground connection. Without the protective ground connection, all accessible conductive parts (including control knobs) can render an electric shock. The power jack and mating plug of the power cable meet IEC safety standards.

## ***DO NOT OPERATE IN AN EXPLOSIVE ATMOSPHERE***

Do not operate the instrument in the presence of flammable gases or fumes. Operation of any electrical instrument in such an environment constitutes a definite safety hazard.

## ***KEEP AWAY FROM LIVE CIRCUITS***

Instrument covers must not be removed by operating personnel. Component replacement and internal adjustments must be made by qualified maintenance personnel. Disconnect the power cord before removing the instrument covers and replacing components. Under certain conditions, even with the power cable removed, dangerous voltages may exist. To avoid injuries, always disconnect power and discharge circuits before touching them.

## ***DO NOT SERVICE OR ADJUST ALONE***

Do not attempt any internal service or adjustment unless another person, capable of rendering first aid and resuscitation, is present.

## ***DO NOT SUBSTITUTE PARTS OR MODIFY THE INSTRUMENT***

Do not install substitute parts or perform any unauthorized modifications to this instrument. Return the instrument to B&K Precision for service and repair to ensure that safety features are maintained.

## WARNINGS AND CAUTIONS

**WARNING** and **CAUTION** statements, such as the following examples, denote a hazard and appear throughout this manual. Follow all instructions contained in these statements.

A **WARNING** statement calls attention to an operating procedure, practice, or condition, which, if not followed correctly, could result in injury or death to personnel.

A **CAUTION** statement calls attention to an operating procedure, practice, or condition, which, if not followed correctly, could result in damage to or destruction of parts or the entire product.

**WARNING:** *Do not alter the ground connection. Without the protective ground connection, all accessible conductive parts (including control knobs) can render an electric shock. The power jack and mating plug of the power cable meet IEC safety standards.*

**WARNING:** *To avoid electrical shock hazard, disconnect power cord before removing covers. Refer servicing to qualified personnel.*

**CAUTION:** *Before connecting the line cord to the AC mains, check the rear panel AC line voltage indicator. Applying a line voltage other than the indicated voltage can destroy the AC line fuses. For continued fire protection, replace fuses only with those of the specified voltage and current ratings.*

**CAUTION:** *This product uses components which can be damaged by electrostatic discharge (ESD). To avoid damage, be sure to follow proper procedures for handling, storing and transporting parts and subassemblies which contain ESD-sensitive components.*

## SAFETY SYMBOLS



This symbol on an instrument indicates that the user should refer to the operating instructions located in the manual.

## Certification

We certify that this product met its published specifications at time of shipment from the factory.

# Compliance Statements

Disposal of Old Electrical & Electronic Equipment (Applicable in the European Union and other European countries with separate collection systems)

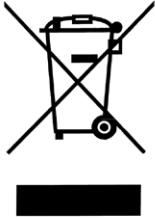

This product is subject to Directive 2002/96/EC of the European Parliament and the Council of the European Union on waste electrical and electronic equipment (WEEE), and in jurisdictions adopting that Directive, is marked as being put on the market after August 13, 2005, and should not be disposed of as unsorted municipal waste. Please utilize your local WEEE collection facilities in the disposition of this product and otherwise observe all applicable requirements.

# Contents

1	Safety Summary.....	1
2	Introduction .....	6
3	Controls and Indicators.....	7
3.1	Front Panel.....	7
3.2	Rear Panel .....	8
4	Operating Instructions.....	9
4.1	Using the Power Supply .....	10
4.1.1	Connection .....	10
4.1.2	Self Test Sequence .....	10
4.1.3	Control Knobs.....	12
4.1.4	Using Both Main and Auxiliary Outputs.....	13
4.2	Control Modes .....	13
4.2.1	Normal Mode .....	14
4.2.2	Preset Mode.....	14
4.2.3	Set Mode.....	15
4.2.4	Analog Remote Control Mode .....	16
5	Remote Control.....	16
5.1	Analog Remote Control.....	16
5.1.1	Using Two External Variable DC Voltage Sources .....	18

5.1.2	Using Two 5 kΩ Variable Resistors.....	19
5.1.3	Enable and Disable the Output .....	20
5.2	PC Interface Control.....	21
5.2.1	General Functions and Display.....	21
5.2.2	External Timed Program .....	22
5.2.3	Internal Preset Memory.....	23
5.2.4	Data Log .....	24
5.2.5	Settings.....	26
5.2.6	Command Set.....	26
6	Faults and Troubleshooting .....	31
6.1	OVP: Overvoltage Protection .....	31
6.2	OTP: Overtemperature Protection.....	32
6.3	OLP: Overload Protection.....	33
6.4	Fuse Replacement.....	33
7	Specifications .....	35
9	Service Information .....	37
10	Limited Two-Year Warranty.....	38

## 2 Introduction

B&K Precision models 1685B, 1687B, and 1688B are laboratory grade switching mode DC power supplies with high current output in a small form factor and lightweight package. The 1685B Series provides various configurations of output voltage and current, and make setting voltage and current levels fast and precise through its dual action, coarse/fine rotary encoder control knobs. In addition to its constant voltage (CV) and constant current (CC) modes, the high efficiency DC power supply offers a unique solution with its preset and analog remote control modes. Save up to three different presets of voltage and current values for quick recall. The analog remote control function allows the output power, voltage, and current to be adjusted without touching the front panel of the power supply. These features make the 1685B Series suitable for a wide range of applications including production testing, telecommunications, R&D, service, and university labs.

### Features

- Automatic CV/CC crossover operation
- Lightweight and compact
- Rotary encoder control for precise voltage and current setting
- Save up to 3 user-defined voltage and current presets for quick recall
- PC software for remote control and external timed programming
- Analog remote control function
- USB interface
- Front panel auxiliary output
- Overvoltage, overtemperature, and overload protection



## 3 Controls and Indicators

### 3.1 Front Panel

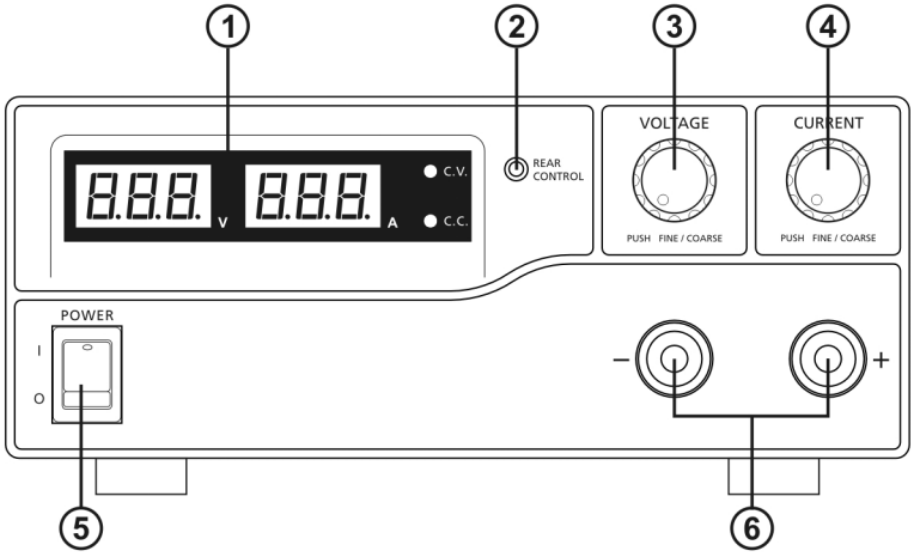

Figure 1 - Front Panel

- (1) LED panel meter display with CV/CC indicator
- (2) Rear Control Indicator (lights up when using Preset/Remote Control/Set mode)
- (3) Output Voltage Control Knob (control main and auxiliary output voltage)
- (4) Output Current Control Knob (control main and auxiliary output current limit)
- (5) Power ON/OFF Switch
- (6) Auxiliary Output Terminal (max 5 A)

**Note:** Please see 4.1.4 Using Both Main and Auxiliary Outputs for more details on using both main and auxiliary output terminals together.

## 3.2 Rear Panel

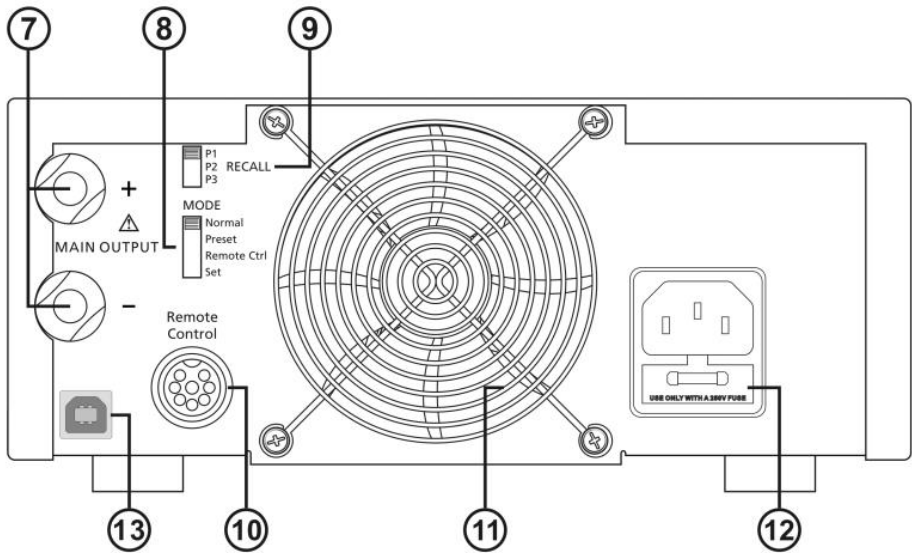

Figure 2 - Rear Panel

**(7)** Main Output Terminal (max 5 A for 1685B / 10 A for 1687B / 20 A for 1688B)

**Note:** Please see 4.1.4 Using Both Main and Auxiliary Outputs for more details on using both main and auxiliary output terminals together.

**(8)** Mode Selection Switch (Normal, Preset, Remote Control, Set Modes)

**(9)** Recall Preset Selection Switch

**(10)** Analog Remote Control Terminal

**(11)** Cooling Fan Air Intake Grille

**(12)** AC Input Plug and Fuse Compartment

**(13)** USB Port (for PC remote control)

## 4 Operating Instructions

### Safety Precautions

- This power supply is for indoor use only.
- Do not expose the power supply to sun, high humidity, or dusty environments.
- Never remove the metal cover of the power supply while AC power is connected.
- Never touch the unit when your hands are wet.
- Never block the ventilation slots and cooling fan air intake window.
- Never attempt to repair the power supply. Incorrect re-assembly may result in a risk of electric shock or fire.
- Never use the power supply for a load requiring higher current than the designed value. Otherwise it may damage the power supply.
- Place the power supply on a flat surface with sufficient clearance and dry, dust-free surroundings for ventilation.

This series has three models with different output voltage and current ranges. Make sure you have purchased the correct one.

<b>Model Number</b>	<b>Output Voltage Range</b>	<b>Total Rated Current</b>
1685B	1 – 60 V	0 – 5 A
1687B	1 – 36 V	0 – 10 A
1688B	1 – 18 V	0 – 20 A

**Table 1 - Model Table**

## 4.1 Using the Power Supply

### 4.1.1 Connection

To connect the equipment to the power supply, follow the steps below.

1. Check the rating label of the power supply and confirm that it complies with your AC mains voltage.
2. Connect the power supply to the AC mains using the provided power cord and make sure the Mode Selection Switch is in the Normal position.
3. Hook up the red (+) terminal to the positive polarity input of the equipment and the black (-) terminal to the negative polarity input of the equipment.
4. Switch on the power supply first. The panel meter and green CV indicator should light up again.
5. Switch on the equipment. The panel meter and green CV indicator should still remain green.
6. When an operation is finished, switch off the equipment first and then switch off the power supply.

### 4.1.2 Self Test Sequence

The power supply will perform a series of self checks when it is switched on. The table below shows the self test sequence.

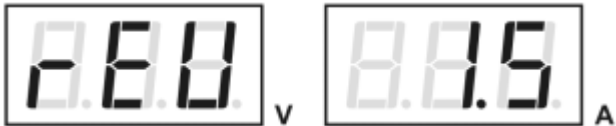
Front Panel Display	Test
 <p>The image shows two digital displays side-by-side. The left display shows '8.8.8' with a 'V' label below it. The right display shows '8.8.9' with an 'A' label below it.</p>	To show software version

Front Panel Display

Test



Segment check

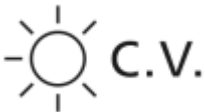

C.V. indicator check

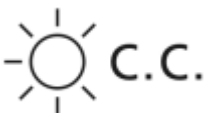

C.C. indicator check

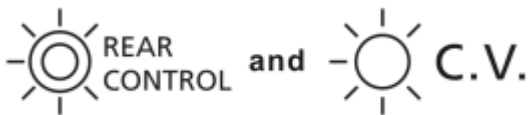

Rear control indicator check



Return to C.V.





Start power supply checks



Overvoltage protection check



Overload protection check

Front Panel Display	Test
	Overtemperature protection check
	Fan check
	Output off (remote control mode)

**Table 2 - Self Test Sequence**

The LED and other indicators on the front panel will be turned on. When the cooling fan is being checked, a loud fan noise can be heard.

After the self checks, the CV, V, and A LED indicators are lit up displaying voltage and 0.0 current. To find out about the set CC current level, just turn the current control knob one click in either direction. The current display returns to 0.0 after a few seconds.

### **4.1.3 Control Knobs**

The rotary encoder control knobs have fine and coarse tuning with clicking movement.

Push the knobs to toggle between coarse and fine tuning. You will notice the subtle change in brightness of LED.

Adjust the knobs to your desired values through coarse and fine tuning. The display will resume its normal brightness after a few seconds to confirm your adjustment.

#### 4.1.4 Using Both Main and Auxiliary Outputs

The power supply has a main output in the rear and an auxiliary output in the front that can be used separately or together.

The main and auxiliary output both share the same voltage and current control knobs and will output the same voltage and current up to the maximum output ratings of the power supply and terminals. When using both the main and auxiliary outputs together, the power supply will automatically total the currents supplied to both terminals up to the current limit of the power supply and show the total current on the display.

For example, setting the voltage and current outputs for model 1688B (1-18 V, 0-20 A) to 18 V and 20 A would output 18 V at both main and auxiliary terminals and allow you to draw up to a total of 20 A between the two terminals. If there is a 5 A load at the auxiliary terminal, the most current you can draw from the main output is 15 A.

If the power supply reaches its set current limit at any time, the power supply will go into CC mode and the loads together will draw up to the total value of the current limit. Distribution of current between the main and auxiliary terminals will vary depending on the loads.

**Note:** 1685B: Total rated current (Aux. + Main) is 5 A  
1687B: Total rated current (Aux. + Main) is 10 A  
1688B: Total rated current (Aux. + Main) is 20 A

## 4.2 Control Modes

There are four different control modes for the power supply:

- Normal
- Preset
- Set
- Remote Control

To select a mode, slide the Mode Selection Switch on the rear of the unit.

**Note:** The power supply is factory preset to Normal Mode with maximum current level.

#### 4.2.1 Normal Mode

This is the factory preset mode and the power supply output voltage and current are controlled by the dual action dial knobs.

Push the knobs to toggle the coarse and fine tuning. You will notice the subtle change in brightness of LED.

Adjust the knobs to your desired values through coarse and fine tuning. To check the preset current level, turn the Current Knob lightly in any direction.

The display will resume its normal brightness after a few seconds to confirm your adjustment.

#### 4.2.2 Preset Mode

In this mode, the Rear Control light is ON to indicate panel voltage and current controls are deactivated.

There are three presets P1/P2/P3 on the Recall Selection Switch. The factory preset values are shown in Table 3 - Default Presets.

The user can also set custom output voltage and current using Set Mode. Please refer to 4.2.3 Set Mode for details.

Recall No.	Output Voltage	Output Current
P1	5 V	Maximum
P2	13.8 V	Maximum
P3	Model 1685B: 55 V Model 1687B: 25 V Model 1688B: 15 V	Maximum

**Table 3 - Default Presets**



### 4.2.3 Set Mode

First, enter Set Mode by pushing Mode Selection Switch to “Set” position.

#### To define the preset output P1/P2/P3

1. Select the Recall Switch to the position you want to set: P1, P2, or P3.
2. Adjust the front panel voltage control knob to set your desired voltage value.
3. Adjust the front panel current control knob to set your desired current limit value.
4. Repeat the procedure for remaining presets P1, P2, or P3 if desired.
5. Move Mode Selection Switch from “Set” to “Preset” position to confirm your settings.

#### To reset the unit back to factory settings

1. Turn OFF the power supply.
2. Push and hold both front panel voltage and current control knobs at the same time.
3. Turn ON the power supply.
4. Release front panel voltage and current control knobs.

#### Note:

- All the set values in the presets will be saved even after the power supply has been turned off.
- Always check output voltage of Presets before connecting to load.
- To check the preset values, move Mode Selection Switch to “Preset” position.
- Move the Recall Switch to P1, P2, or P3.
- The voltage and current settings of corresponding presets P1, P2, or P3 will be shown on the panel meters.

## 4.2.4 Analog Remote Control Mode

Select this mode to control the output voltage and current via remote control connector. Please refer to 5 Remote Control for more details.

# 5 Remote Control

There are two methods to remotely control voltage and current.

**Note:** Both methods require the remote control connector plug to be set up in order for analog remote control mode to be functional; otherwise the unit will be in CC mode all the time.

## 5.1 Analog Remote Control

Set up the provided remote connector plug.

- (a) Remove the black portion of the remote control connector plug by removing the screw as shown in Figure 33.



Figure 3 - Remote Control Connector

- (b) Solder 5 wires (22AWG) to pins 1, 2, 3, 4, and 5 of pin plug. Refer to Figure 44 for pin numbers.

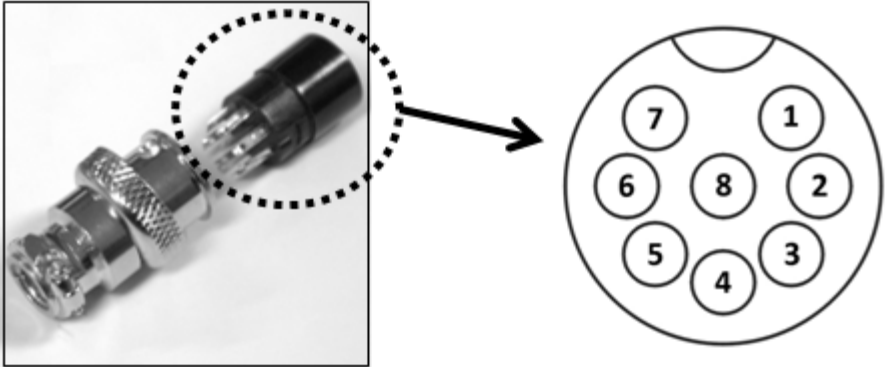

**Figure 4 - Pin Numbers**

- (c) Make sure the load is disconnected and the power supply is OFF.
- (d) Plug the remote connector plug into the analog remote control terminal of the power supply.
- (e) Secure the remote connector plug to the terminal socket by screwing in the connector ring (Figure 55).

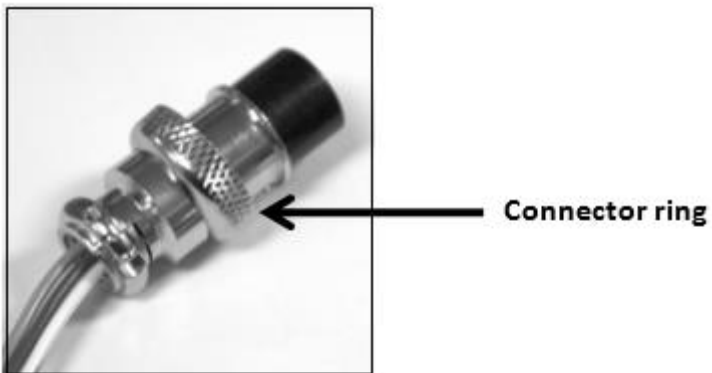

**Figure 5 - Connector Ring**

Then, you can choose one of the following two methods to use the analog remote control feature: (1) Using two external variable DC voltage sources or (2) using two 5 k $\Omega$  variable resistors.

### 5.1.1 Using Two External Variable DC Voltage Sources

PIN	FUNCTIONS	REMARKS
1	Internal DC +5 V	Less than 50 mA
2	Voltage Adjust	0 – 5 V
3	Current Adjust	0 – 5 V
4	Ground	
5	Output OFF	Short to Ground
6	N/A	
7	N/A	
8	N/A	

**Table 4 – Remote Connector Plug Pin Assignment for External Variable Voltage Sources**

A variable external DC voltage source of 0 – 5 V is fed into the analog remote control terminal to adjust the output voltage level of both Main and Auxiliary output.

**WARNING: Do not input higher than 5 V, otherwise the overvoltage protection (OVP) will be triggered.**

1. Make sure the load is disconnected and the power supply is OFF.
2. Connect pin 2 to positive polarity of first external voltage source and pin 4 to negative polarity of first external voltage source.
3. Connect pin 3 to positive polarity of second external voltage source and pin 4 to negative polarity of second external voltage source.
4. Turn the remote control ON/OFF switch to ON position.

5. Switch on the power supply.
6. Check the output voltage range of the power supply by varying the external voltage source for voltage adjustment from 0 to 5 V.
7. Short circuit the main output with an 8AWG gauge wire and check the display for CC setting by varying the external voltage source for current adjustment from 0 to 5 V.
8. Switch off the power supply.

### 5.1.2 Using Two 5 kΩ Variable Resistors

1. Make sure the load is disconnected and the power supply is OFF.
2. Prepare two 5 kΩ variable resistors and connect wires from pins 1, 2, 3, and 4 as shown in **Error! Reference source not found..**

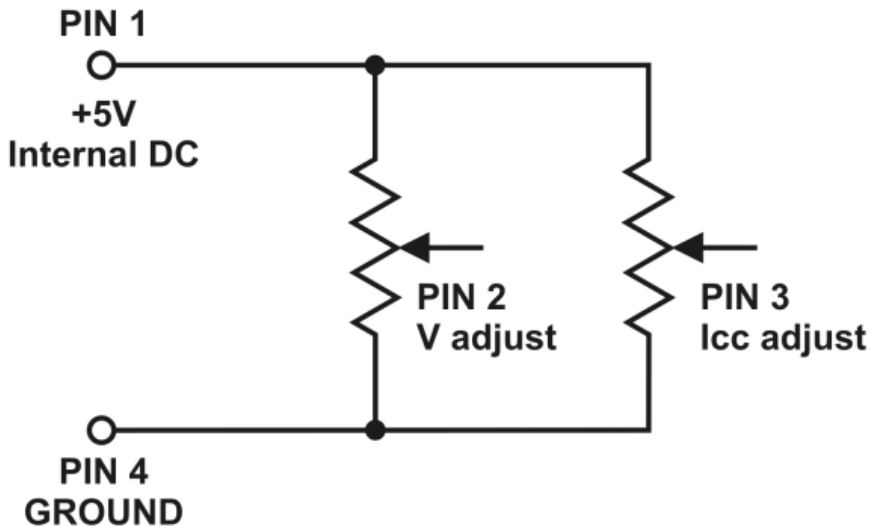

Figure 6 - Variable 5 kΩ Resistors Setup

PIN	FUNCTIONS	REMARKS
1	Internal DC +5 V	Resistor end
2	Voltage Adjust	Variable part of resistor
3	Current Adjust	Variable part of resistor
4	Ground	Resistor end
5	Output OFF	Short to Ground
6	N/A	
7	N/A	
8	N/A	

**Table 5 – Remote Connector Plug Pin Assignment for Variable Resistors**

3. Turn the remote control ON/OFF switch to ON position.
4. Switch on the power supply.
5. Check the output voltage range of the power supply by varying the 5 k $\Omega$  variable resistor for voltage adjustment.
6. Short circuit the main output with 8AWG gauge wire and check the display for CC setting by varying the 5 k $\Omega$  variable resistor for current adjustment.
7. Switch off the power supply.

### **5.1.3 Enable and Disable the Output**

This remote output on/off control can be activated in any of the modes.

By default, Pin 5 is open and output is on.

Shorting Pin 5 to Pin 4 (ground) will turn the output off.

When output is off, the CV and CC LED will flash. The current output voltage and current setting will show on the panel meter.

You can also adjust the output by voltage and current control knob to your desired value when output is off.

## 5.2 PC Interface Control

**Note:** The power supply must be in Normal Mode for PC interface control.

### 5.2.1 General Functions and Display

The remote control PC software will display all output voltage, current, and power readings. Power supply voltage and current values can be set in two different ways. Values can either be entered via keyboard or set by clicking on the displayed voltage and current setting (left click to increase value, right click to decrease value). The output status is also shown and can also be clicked to set the power supply output ON or OFF.

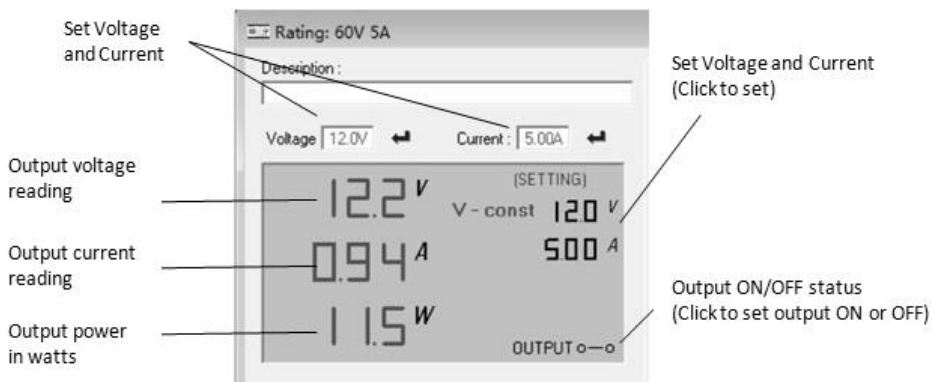

Figure 7 - PC Software General Functions and Display

## 5.2.2 External Timed Program

External Timed Program is completely controlled by the PC. The PC counts the step time and changes the specified voltage and current levels of the power supply.

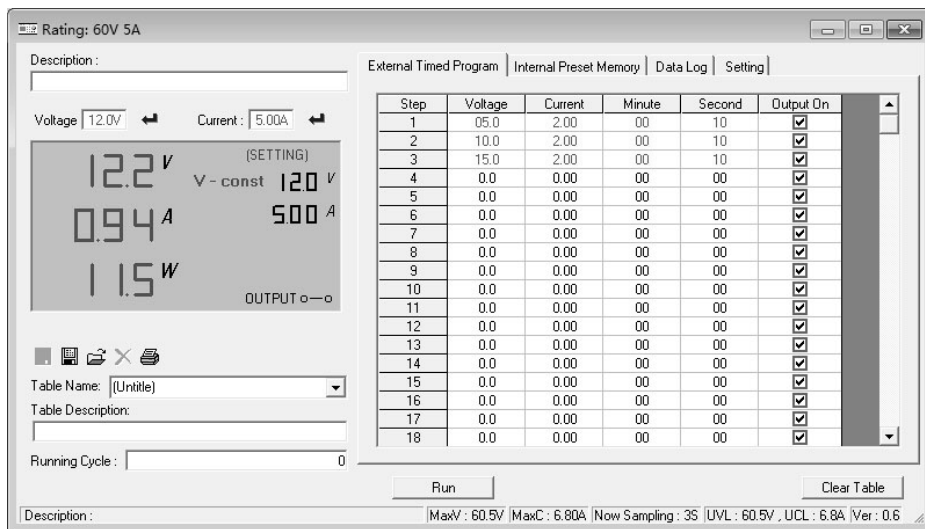

Figure 8 - External Timed Program

### External Timed Program Procedure

1. Select External Timed Program tab to switch to the External Timed Program function.
2. Enter voltage, current, and time parameters for number of steps needed in timed program. (Maximum of 20 steps can be entered)
3. Specify desired number of running cycles. Up to 999 running cycles can be entered. Enter 0 for continuous cycle.
4. To run the timed program, click the “Run” button.
5. To save the table, enter Table Name in box and click the “Save Table” icon. The timed program table data can be classified, stored, exported to a csv file, deleted, printed, or retrieved for use at any time.
6. To delete all data in the table, click the “Clear Table” button.



## 5.2.3 Internal Preset Memory

The Internal Preset Memory tab allows you to define the power supply's presets remotely.

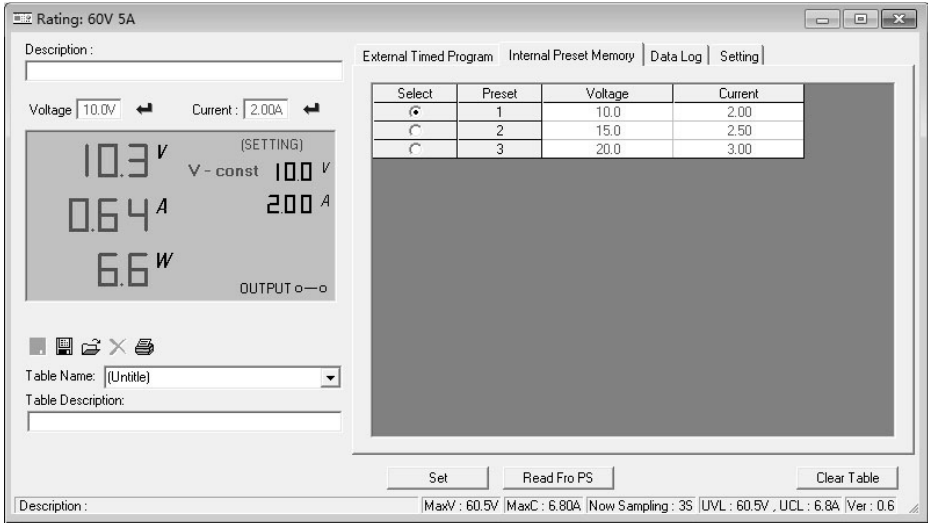

**Figure 9 - Internal Preset Memory**

### Internal Preset Memory Procedure

1. Select Internal Preset Memory tab to switch to the Internal Preset Memory function.
2. Enter in desired Voltage and Current values for Presets 1, 2, and 3.
3. Click “Set” to select and save Presets.
4. To get power supply's currently stored presets, click the “Read from PS” button.
5. Retrieved data will be shown in red if they exceed the present preset upper voltage and current limit value.
6. To save the table, enter Table Name in box and click “Save Table” icon. Data of different groups of presets can be classified, stored, exported to a csv file, printed, or retrieved for use at any time.
7. To delete all data in the table, click the “Clear Table” button.

## 5.2.4 Data Log

The Data Log window can be used to view present or stored output data. All parameters at the bottom of the window can be changed via direct entry from the PC and confirmed by pressing Enter or selecting the values from the drop down menu.

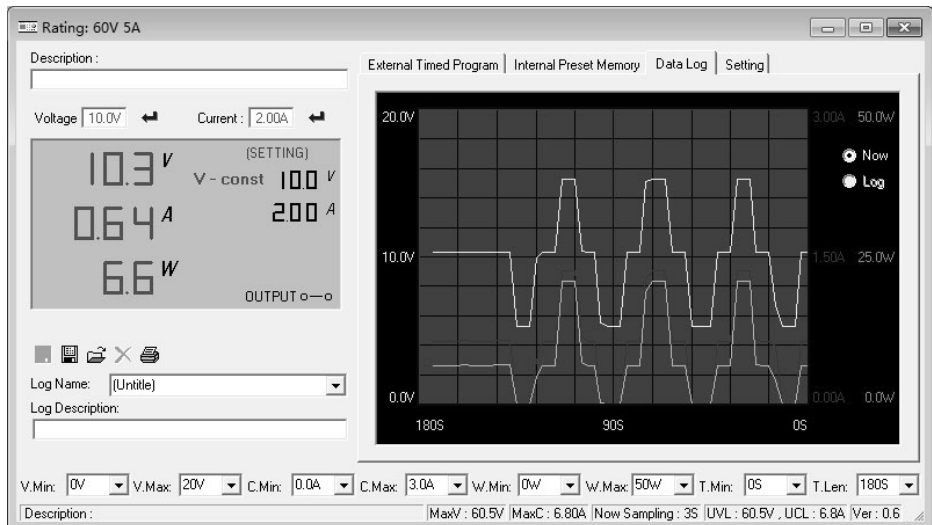

Figure 10 - Data Log Window

### Parameters in Data Log

V Min: Minimum voltage level

V Max: Maximum voltage level

C Min: Minimum current level

C Max: Maximum current level

W Min: Minimum power level in watts

W Max: Maximum power level in watts

T Min: Time minimum

T Len: Time length

To save a data log, enter Log Name in box and click the “Save Log” icon.

After saving, the log can be retrieved by selecting it in the Log Name drop down menu.

Data logs can be classified, stored, exported to a csv file, printed, or retrieved for use at any time.

### **THE TIME FRAME CONCEPT OF DATA LOG**

The data logging function starts when the software begins to run.

When **T Min** is set to 0 seconds, it means the data is in real-time and the length of time lapsed is on the left hand side of the Time Minimum.

**T Len** is the length of time lapsed starting from the Time Minimum.

Both parameters are adjustable so that any time period of the log can be displayed for analysis.

In the figure below, T Min is set to 10 seconds and T length to 120 seconds. The display shows the output data starting at 0 seconds ago and ending at the 130-second mark.

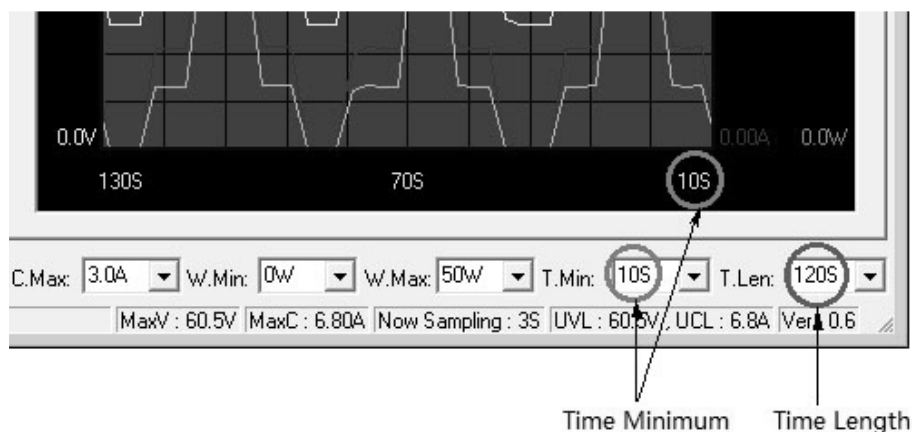

**Figure 11 - Time Minimum and Time Length**

## 5.2.5 Settings

Use this tab to configure your settings.

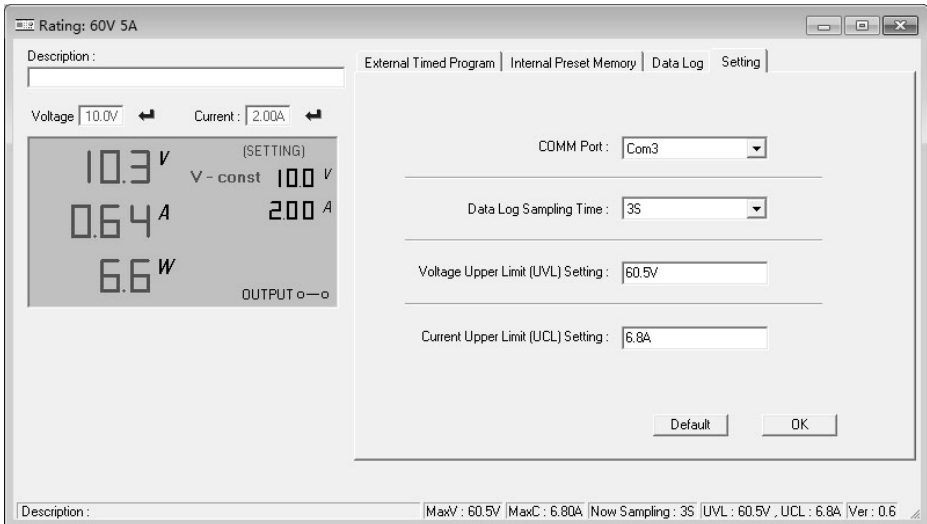

**Figure 12 - Settings Configuration**

**Data Log Sampling Time:** You can select your desired data log sampling time from 1 second and up.

**Voltage Upper Limit (UVL) Setting:** You can set your output voltage upper limit value to safeguard your low voltage applications.

**Current Upper Limit (UCL) Setting:** You can set your output current upper limit value to safeguard your low current applications.

## 5.2.6 Command Set

**Note:** In order to use remote commands, please make sure to use the following communication settings - Baud rate: 9600, Data bits: 8, Parity: none, Stop bits: 1. If you are using HyperTerminal, make sure to check your ASCII setup to not append line feeds.

**Command line format: COMMAND<parameter1><parameter2>...[CR]**

**Current value will have one decimal place for models 1687B and 1688B, and two decimal places for Model 1685B.**

Command code & Return value	Function	Example
Input command: VOLT{<voltage>}[CR]  Return value: OK[CR]	Set voltage level <voltage> = 000-XXX	Input command: VOLT010[CR]  Return value: OK[CR]  Sets voltage level to 1.0 V
Input command: CURR{<current>}[CR]  Return value: OK[CR]	Set current level <current> = 000-XXX	Input command: CURR025[CR]  Return value: OK[CR]  Sets current level to 2.5 A
Input command: PROM{<preset 1 voltage>}{<preset 1 current>}{<preset 2 voltage>}{<preset 2 current>}{<preset 3 voltage>}{<preset 3 current>}[CR]  Return value: OK[CR]	Set power supply preset memory values  <preset X voltage> = 000-XXX <preset X current> = 000-XXX	Input command: PROM011022033044055066  Return value: OK[CR]  Sets preset 1 voltage and current to 1.1 V and 2.2 A, preset 2 voltage and current to 3.3 V and 4.4 A, and preset 3 voltage and current to 5.5 V and 6.6 A
Input command: GETS[CR]  Return value: [voltage][current][CR] OK[CR]	Get voltage and current setting values from power supply  [voltage] = 000-XXX [current] = 000-XXX	Input command: GETS[CR]  Return value: 025051 OK  Indicates voltage setting is 2.5 V and current setting is 5.1 A

Command code & Return value	Function	Example
Input command: GETD[CR]  Return value: [voltage][current][status][CR] OK[CR]	Get display voltage, current, and status reading from power supply  [voltage] = 0000-XXXX [current] = 0000-XXXX [status] = 0 1 (0=CV, 1=CC)	Input command: GETD[CR]  Return value: 030201450 OK  Indicates voltage reading is 3.02 V and current reading is 1.45 A. Power supply is in CV mode
Input command: GETM[CR]  Return value: [preset 1 voltage] [preset 1 current][CR] [preset 2 voltage][preset 2 current][CR] [preset 3 voltage][preset 3 current][CR] OK[CR]	Get preset memory values  <preset 1 2 3 voltage> = 000-XXX <preset 1 2 3 current> = 000-XXX	Input command: GETM[CR]  Return value: 015015 025025 035035 OK  Indicates preset 1 voltage and current is 1.5 V and 1.5 A, preset 2 voltage and current is 2.5 V and 2.5 A, preset 3 voltage and current is 3.5 V and 3.5 A
Input command: RUNM{<memory>}[CR] ]  Return value: OK[CR]	Set voltage and current using values saved in preset memory locations  <memory>=0 1 2 0 = preset 1 values 1 = preset 2 values 2 = preset 3 values	Input command: RUNM0[CR]  Return value: OK[CR]  Sets voltage and current using values from memory location 1

Command code & Return value	Function	Example
Input command: SOUT{<output>}[CR]  Return value: OK[CR]	Output On/Off control  <output> = 0 1 0=ON 1=OFF	Input command: SOUT1[CR]  Return value: OK[CR]  Switches output OFF
Input command: SOVP{<voltage>}[CR]  Return value: OK[CR]	Set upper voltage limit of power supply  <voltage> = 000-XXX	Input command: SOVP151[CR]  Return value: OK[CR]  Sets upper voltage limit to 15.1 V
Input command: SOCP{<current>}[CR]  Return value: OK[CR]	Set upper current limit of power supply  <current> = 000-XXX	Input command: SOCP108[CR]  Return value: OK[CR]  Sets upper current limit to 10.8 A
Input command: GOVP[CR]  Return value: [voltage][CR] OK[CR]	Get upper voltage limit of power supply  [voltage] = 000-XXX	Input command: GOVP[CR]  Return value: 152 OK  Indicates upper voltage limit is set to 15.2 V

Command code & Return value	Function	Example
Input command: GOCP[CR]  Return value: [current][CR] OK[CR]	Get upper current limit of power supply  [current] = 000-XXX	Input command: GOCP[CR]  Return value: 052 OK  Indicates maximum current limit is set to 5.2 A
Input command: GMAX[CR]  Return value: [voltage][current][CR] OK[CR]	Get power supply maximum voltage and current values  <voltage> = 000-XXX <current> = 000-XXX	Input command: GMAX[CR]  Return value: 180200[CR] OK[CR]  Indicates maximum voltage is 18.0 V and maximum current is 20.0 A



## **6      Faults and Troubleshooting**

### **6.1    OVP: Overvoltage Protection**

This unit has a built-in tracking overvoltage protection feature. In the event of the output voltage becoming greater than the set value (see specified range from

7 S section), protection will be triggered, and the output power will be cut off. OVP warning will appear as shown below.



**Figure 13 - Overvoltage Protection**

To reset the warning, switch off the unit and remove all connected devices. Switch the unit back on again and it should resume normal operation. If the problem persists, please contact B&K Precision.

## **6.2 OTP: Overtemperature Protection**

There is a thermo sensor inside the unit to monitor and prevent the unit from getting too hot. When OTP is triggered, there is no output and the following warning will appear on the LED display.



**Figure 14 - Overtemperature Protection**

When you get this warning, switch off the unit and remove all loading. Check your load and output settings and allow the unit to cool down for at least 30 minutes. Check if any of the ventilation is blocked and make sure there is enough clearance around the power supply. Listen carefully for the fan noise from the cooling fan when you turn on the unit again. If you cannot hear this routine self test fan noise upon power on, the fan has failed and the power supply should not be used. In this case, please contact B&K Precision.

### 6.3 OLP: Overload Protection

Normally the overload protection is sustained by the CC constant current mode. When the CC mode fails and goes undetected, it may cause serious damage to your device under test. The OLP is to minimize the extent of damage to your loads as power supplies will fail at some point in time. Switch off your power supply as soon as you see this warning as shown in Figure 15 - Overload Protection.



Figure 15 - Overload Protection

To reset this warning, switch off the unit and remove all connected devices. Switch the unit back on again and double check with caution. If the problem persists, please contact B&K Precision.

### 6.4 Fuse Replacement

If the fuse blows, the CV or CC indicators will not light and the power supply will not operate. The fuse should not normally open unless a problem has developed in the unit. Try to determine and correct the cause of the blown fuse, then replace only with a fuse of the correct rating as listed below. The fuse is located on the rear panel (see Figure 2 - Rear Panel). Pull fuse compartment out with a flathead screwdriver and replace fuse in holder.

Line Voltage	Fuse	Type
100 – 240 VAC	6 A/250 V	20mm standard glass tube fast blow

**Table 6 - Fuse Table**

## 7 Specifications

Models	1685B	1687B	1688B
<b>Output</b>			
Variable Output Voltage	1 – 60 V	1 – 36 V	1 – 18 V
Variable Output Current	0 – 5 A	0 – 10 A	0 – 20 A
<b>Voltage Regulation</b>			
Load (0-100% Load)	≤ 50 mV		
Line (90-132 VAC, 170-264 VAC Variation)	≤ 20 mV		
<b>Current Regulation</b>			
Load (10-90% Rated Voltage)	≤ 100 mA		
Line (90-132 VAC, 170-264 VAC Variation)	≤ 50 mA		
<b>Ripple &amp; Noise</b>			
Ripple & Noise Voltage (rms)	≤ 5 mV		
Ripple & Noise Voltage (peak-peak)	≤ 50 mV		
Current Ripple & Noise (rms)	≤ 30 mA		
<b>Meter Type &amp; Accuracy</b>			
Voltage Meter	3-Digit LED Display ± 0.2% + 3 counts		
Current Meter	3-Digit LED Display ± 0.2% + 3 counts		
<b>Other</b>			
Input Voltage	100-240 VAC 50/60 Hz		
Full Load Input Current	3.7 A (100 VAC) 1.7 A (230 VAC)	4.6 A (100 VAC) 2.1 A (230 VAC)	4.6 A (100 VAC) 2.1 A (230 VAC)
Efficiency	82% (100 VAC) 86% (230 VAC)	82% (100 VAC) 86% (230 VAC)	81% (100 VAC) 85% (230 VAC)
Switching Frequency	100 – 120 kHz		

Models	1685B	1687B	1688B
Tracking Overvoltage Protection	O/P 1-5 V: set voltage +2 V O/P 5-20 V: set voltage +3 V O/P 20-60 V: set voltage +4 V	O/P 1-5 V: set voltage +2 V O/P 5-20 V: set voltage +3 V O/P 20-36 V: set voltage +4 V	O/P 1-5 V: set voltage +2 V O/P 5-18 V: set voltage +3 V
Transient Response Time (50-100% Load)	1.5 ms		
Power Factor Correction	> 0.95 at optimal load		
Cooling Method	Thermostatically controlled fan from zero to full speed		
Protections	Overvoltage, Overtemperature, Overload		
Special Features	3 User-Defined Voltage and Current Presets, Analog Remote Control		
External Timed Programming	Max. 20 voltage and current steps Max. 99 min + 59 sec step time Max. 999 running cycles		
Operating Temperature	32 °F to 104 °F (0 °C to 40 °C) ≤ 80% R.H.		
Storage Temperature	5 °F to 158 °F (-15 °C to 70 °C) ≤ 85% R.H.		
Dimensions (WxHxD)	7.9" x 3.5" x 8.2" (200 x 90 x 208 mm)		
Weight	5.2 lbs (2.4 kg)		
Supplied Accessories	Power cord, instruction manual, application software CD, USB cable, remote control connector		

**Note:** All specifications apply to the unit after a temperature stabilization time of 15 minutes over an ambient temperature range of 23 °C ± 5 °C. Specifications are subject to change without notice.

To ensure the most current version of this manual, please download the latest version here: <http://www.bkprecision.com/search/1685B>

For current up-to-date product information, please visit [www.bkprecision.com](http://www.bkprecision.com)

## 9 Service Information

---

**Warranty Service:** Please go to the support and service section on our website at [www.bkprecision.com](http://www.bkprecision.com) to obtain an RMA #. Return the product in the original packaging with proof of purchase to the address below. Clearly state on the RMA the performance problem and return any leads, probes, connectors, and accessories that you are using with the device.

**Non-Warranty Service:** Please go to the support and service section on our website at [www.bkprecision.com](http://www.bkprecision.com) to obtain an RMA #. Return the product in the original packaging to the address below. Clearly state on the RMA the performance problem and return any leads, probes, connectors, and accessories that you are using with the device. Customers not on an open account must include payment in the form of a money order or credit card. For the most current repair charges, please refer to the service and support section on our website.

Return all merchandise to B&K Precision Corp. with pre-paid shipping. The flat-rate repair charge for Non-Warranty Service does not include return shipping. Return shipping to locations in North America is included for Warranty Service. For overnight shipments and non-North American shipping fees, please contact B&K Precision Corp.

B&K Precision Corp.  
22820 Savi Ranch Parkway  
Yorba Linda, CA 92887  
[www.bkprecision.com](http://www.bkprecision.com)  
714-921-9095

**Include with the returned instrument your complete return shipping address, contact name, phone number, and description of problem.**

## 10 Limited Two-Year Warranty

---

B&K Precision Corp. warrants to the original purchaser that its products and the component parts thereof will be free from defects in workmanship and materials, for a period of **two years** from date of purchase.

B&K Precision Corp. will, without charge, repair or replace, at its option, defective product or component parts. Returned product must be accompanied by proof of the purchase date in the form of a sales receipt.

To obtain warranty coverage in the U.S.A., this product must be registered by completing a warranty registration form on our website [www.bkprecision.com](http://www.bkprecision.com) within fifteen (15) days of purchase.

**Exclusions: This warranty does not apply in the event of misuse or abuse of the product or as a result of unauthorized alterations or repairs. The warranty is void if the serial number is altered, defaced, or removed.**

B&K Precision Corp. shall not be liable for any consequential damages, including without limitation, damages resulting from loss of use. Some states do not allow limitations of incidental or consequential damages. So the above limitation or exclusion may not apply to you.

This warranty gives you specific rights and you may have other rights, which vary from state-to-state.

B&K Precision Corp.  
22820 Savi Ranch Parkway  
Yorba Linda, CA 92887  
[www.bkprecision.com](http://www.bkprecision.com)  
714-921-9095



(Page intentionally left blank)



22820 Savi Ranch Parkway

Yorba Linda, CA 92887

[www.bkprecision.com](http://www.bkprecision.com)

© 2012 B&K Precision Corp.