

## BARBARA-G2-S

~12° spot beam compatible with LEDiL HEKLA

### SPECIFICATION:

Dimensions	Ø 70.0 mm
Height	41.9 mm
Fastening	socket
ROHS compliant	yes ⓘ

### MATERIALS:

Component	Type	Material	Colour	Finish	Coating
BARBARA-G2-S	Reflector	PC	metal		

### ORDERING INFORMATION:





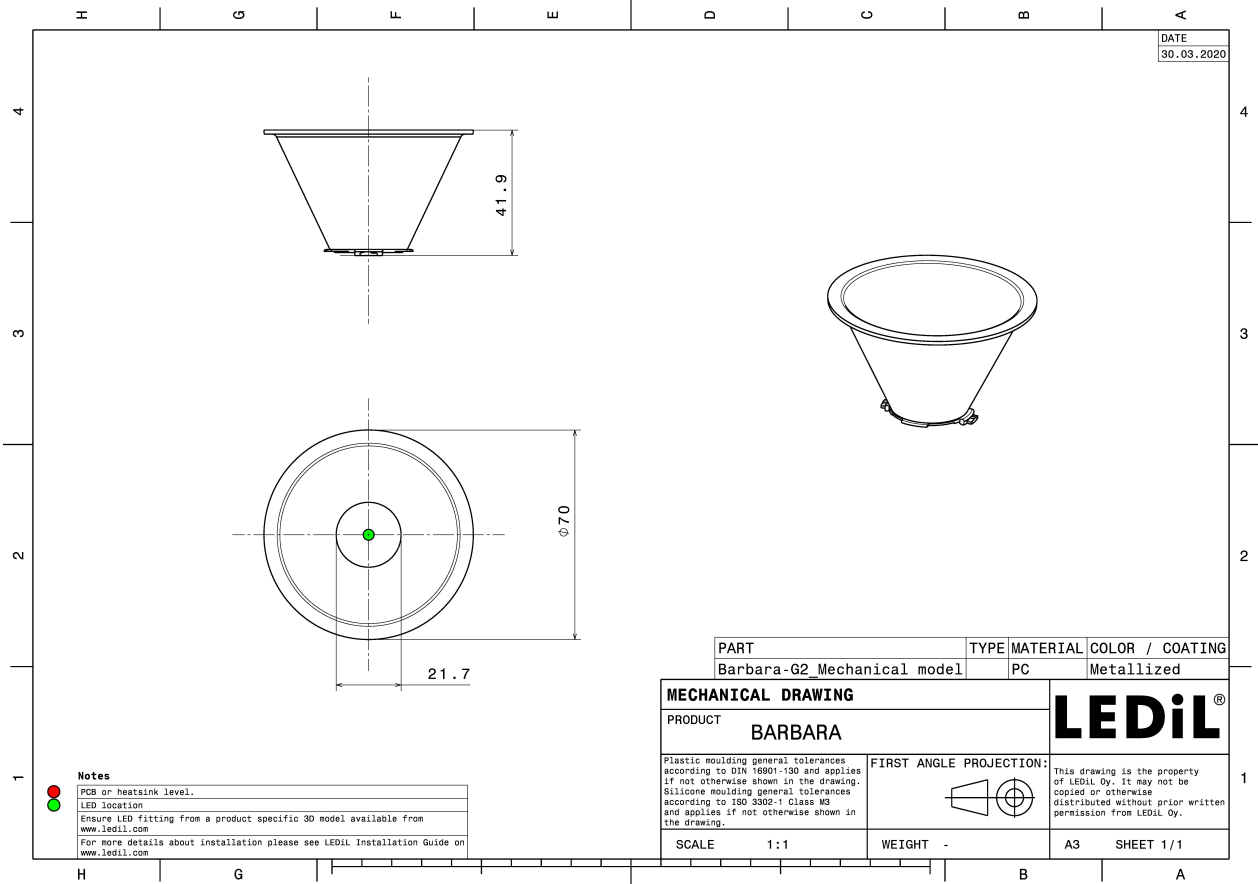



Component	Qty in box	MOQ	MPQ	Box weight (kg)
F16363_BARBARA-G2-S » Box size: 480 x 280 x 300 mm	252	90	18	4.6



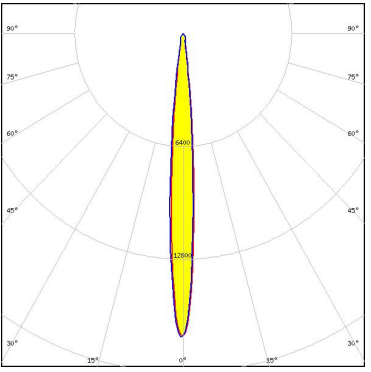

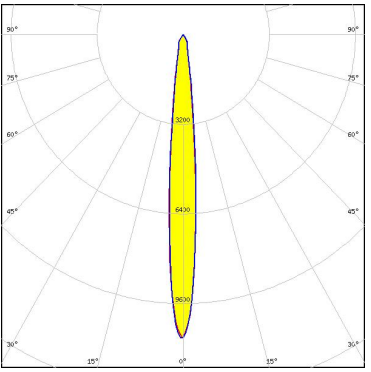

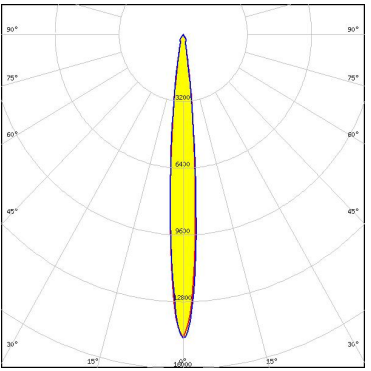

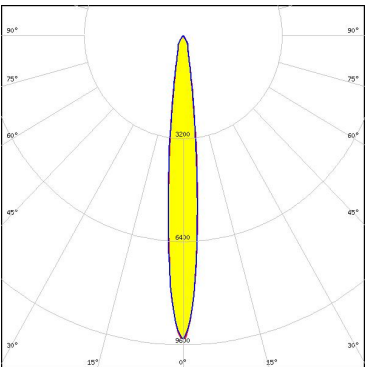

See also our general installation guide: [www.ledil.com/installation\\_guide](http://www.ledil.com/installation_guide)

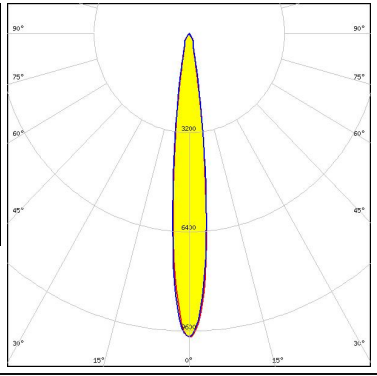

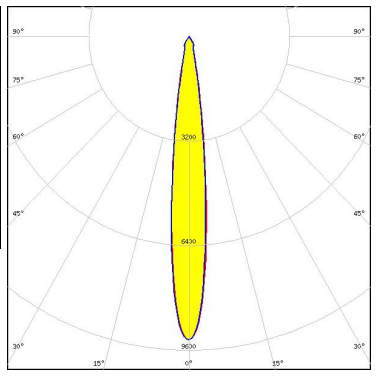

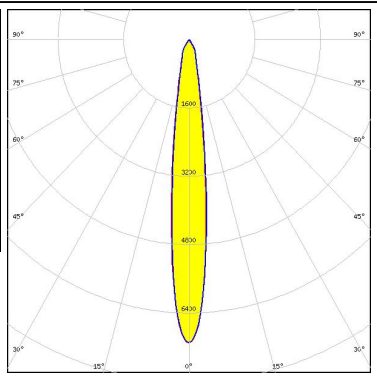

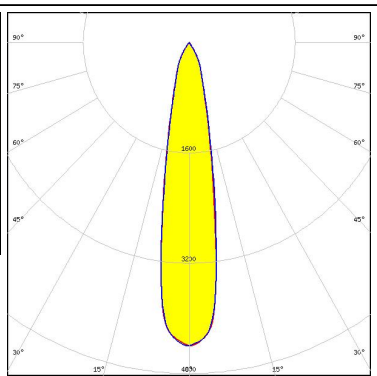

#### OPTICAL RESULTS (MEASURED):

<p></p> <p>LED V4 HD Gen 7</p> <p>FWHM / FWTM 9.0° / 19.0°</p> <p>Efficiency 91 %</p> <p>Peak intensity 17.3 cd/lm</p> <p>LEDs/each optic 1</p> <p>Light colour White</p> <p>Required components: F15253_HEKLA-SOCKET-A</p>		
<p></p> <p>LED V4 HD Gen 7</p> <p>FWHM / FWTM 10.0° / 24.0°</p> <p>Efficiency 86 %</p> <p>Peak intensity 10.9 cd/lm</p> <p>LEDs/each optic 1</p> <p>Light colour White</p> <p>Required components: F15253_HEKLA-SOCKET-A C14658_BARBARA-RZ-LENS</p>		
<p></p> <p>LED V6 HD Gen 7</p> <p>FWHM / FWTM 10.0° / 21.0°</p> <p>Efficiency 91 %</p> <p>Peak intensity 14.6 cd/lm</p> <p>LEDs/each optic 1</p> <p>Light colour White</p> <p>Required components: F15255_HEKLA-SOCKET-C</p>		
<p></p> <p>LED V6 HD Gen 7</p> <p>FWHM / FWTM 11.0° / 27.0°</p> <p>Efficiency 86 %</p> <p>Peak intensity 9.5 cd/lm</p> <p>LEDs/each optic 1</p> <p>Light colour White</p> <p>Required components: F15255_HEKLA-SOCKET-C C14658_BARBARA-RZ-LENS</p>		

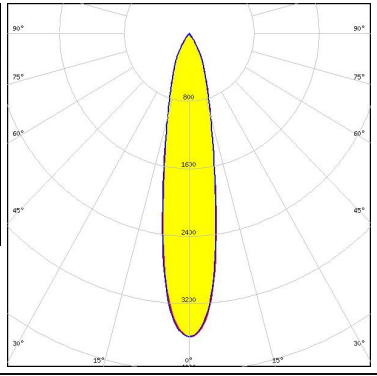
#### OPTICAL RESULTS (MEASURED):

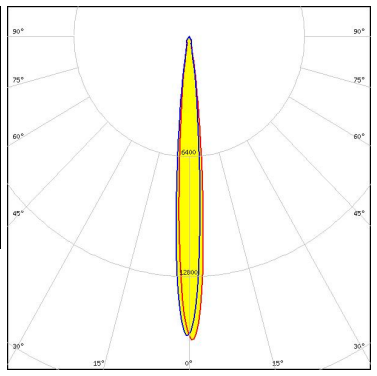
<p>bridgelux.</p> <p>LED V9 HD Gen7</p> <p>FWHM / FWTM 13.0° / 26.0°</p> <p>Efficiency 91 %</p> <p>Peak intensity 9.8 cd/m</p> <p>LEDs/each optic 1</p> <p>Light colour White</p> <p>Required components: F15859_HEKLA-SOCKET-I</p>		
<p>bridgelux.</p> <p>LED V9 HD Gen7</p> <p>FWHM / FWTM 13.0° / 28.0°</p> <p>Efficiency 89 %</p> <p>Peak intensity 9.3 cd/m</p> <p>LEDs/each optic 1</p> <p>Light colour White</p> <p>Required components: F15256_HEKLA-SOCKET-D</p>		
<p>bridgelux.</p> <p>LED V9 HD Gen7</p> <p>FWHM / FWTM 14.0° / 33.0°</p> <p>Efficiency 85 %</p> <p>Peak intensity 7.1 cd/m</p> <p>LEDs/each optic 1</p> <p>Light colour White</p> <p>Required components: F15859_HEKLA-SOCKET-I C14658_BARBARA-RZ-LENS</p>		
<p>bridgelux.</p> <p>LED Vesta DTW 13mm (21W)</p> <p>FWHM / FWTM 20.0° / 47.0°</p> <p>Efficiency 87 %</p> <p>Peak intensity 4.4 cd/m</p> <p>LEDs/each optic 1</p> <p>Light colour Tunable White</p> <p>Required components: C16142_HEKLA-SOCKET-K Bender Wirth: 491 Typ L8</p>		

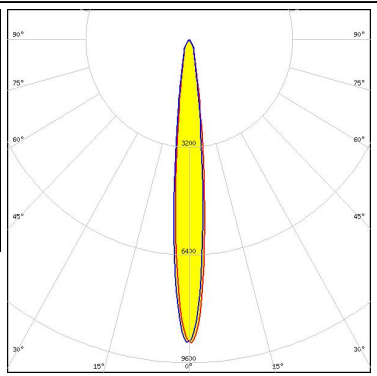
#### OPTICAL RESULTS (MEASURED):

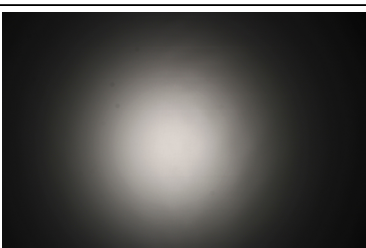
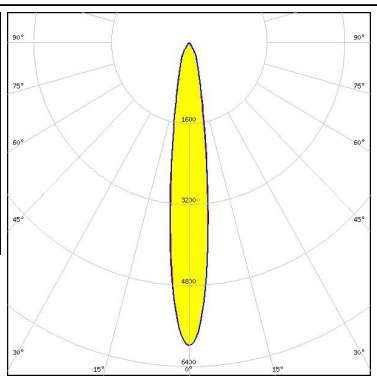
<p></p> <p>LED Vesta DTW 13mm (21W)            FWHM / FWTM 21.0° / 54.0°            Efficiency 81 %            Peak intensity 3.6 cd/lm            LEDs/each optic 1            Light colour Tunable White</p> <p>Required components:            C16142_HEKLA-SOCKET-K            C14658_BARBARA-RZ-LENS            Bender Wirth: 491 Typ L8</p>		
<p></p> <p>LED Vesta TW 6mm DP            FWHM / FWTM 10.0° / 20.0°            Efficiency 86 %            Peak intensity 16.2 cd/lm            LEDs/each optic 1            Light colour White</p> <p>Required components:            C16142_HEKLA-SOCKET-K            Bender Wirth: 504 Typ L8</p>		
<p></p> <p>LED Vesta TW 6mm DP            FWHM / FWTM 11.0° / 27.0°            Efficiency 82 %            Peak intensity 9 cd/lm            LEDs/each optic 1            Light colour White</p> <p>Required components:            C16142_HEKLA-SOCKET-K            C14658_BARBARA-RZ-LENS            Bender Wirth: 504 Typ L8</p>		
<p></p> <p>LED Vesta TW 9mm (12W) CSP            FWHM / FWTM 15.0° / 38.0°            Efficiency 83 %            Peak intensity 6 cd/lm            LEDs/each optic 1            Light colour White</p> <p>Required components:            C16142_HEKLA-SOCKET-K            C14658_BARBARA-RZ-LENS</p>		

#### OPTICAL RESULTS (MEASURED):

#### CITIZEN

LED CLC030 Series (Dim-To-Warm)  
 FWHM / FWTM 21.0° / 55.0°  
 Efficiency 81 %  
 Peak intensity 3.5 cd/m  
 LEDs/each optic 1  
 Light colour White  
 Required components:  
 C16142\_HEKLA-SOCKET-K  
 C14658\_BARBARA-RZ-LENS  
 Bender Wirth: 436 Typ L8

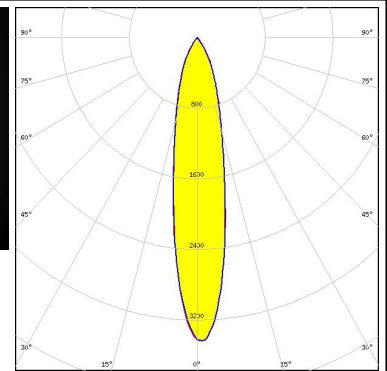

#### CITIZEN

LED CLC030 Series (Dim-To-Warm)  
 FWHM / FWTM 18.0° / 47.0°  
 Efficiency 86 %  
 Peak intensity 4.6 cd/m  
 LEDs/each optic 1  
 Light colour White  
 Required components:  
 C16142\_HEKLA-SOCKET-K  
 Bender Wirth: 436 Typ L8

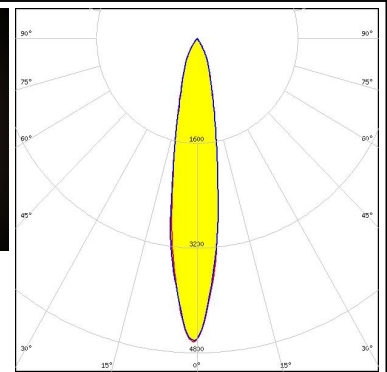

#### CITIZEN

LED CLL02x/CLU02x (LES10)  
 FWHM / FWTM 13.0° / 28.0°  
 Efficiency 91 %  
 Peak intensity 9.3 cd/m  
 LEDs/each optic 1  
 Light colour White  
 Required components:  
 F15255\_HEKLA-SOCKET-C

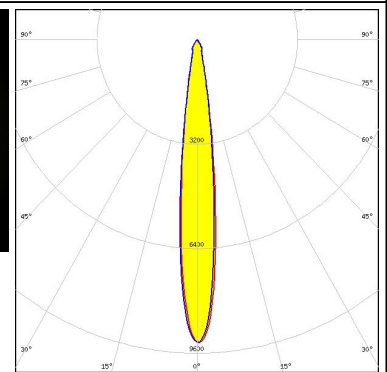

#### CITIZEN

LED CLL03x/CLU03x  
 FWHM / FWTM 21.0° / 48.0°  
 Efficiency 91 %  
 Peak intensity 4.4 cd/m  
 LEDs/each optic 1  
 Light colour White  
 Required components:  
 F15859\_HEKLA-SOCKET-I

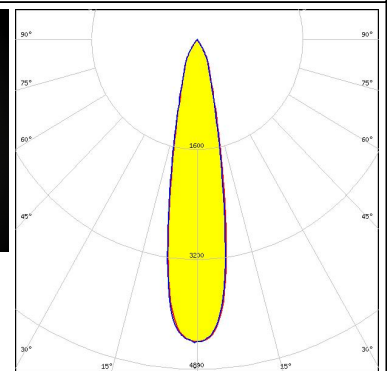
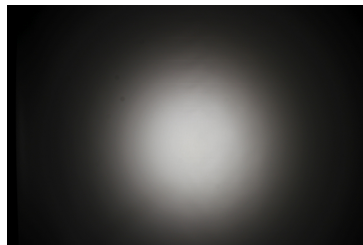

#### OPTICAL RESULTS (MEASURED):

#### CITIZEN

LED CLU700/701/702/703  
 FWHM / FWTM 10.0° / 22.0°  
 Efficiency 90 %  
 Peak intensity 13.6 cd/lm  
 LEDs/each optic 1  
 Light colour White  
 Required components:  
 F15255\_HEKLA-SOCKET-C

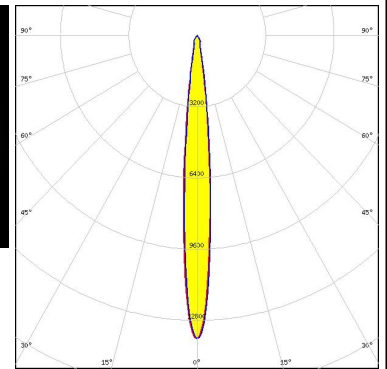

#### CITIZEN

LED LCN-C02B (Tunable White)  
 FWHM / FWTM 19.0° / 50.0°  
 Efficiency 81 %  
 Peak intensity 3.9 cd/lm  
 LEDs/each optic 1  
 Light colour Tunable White  
 Required components:  
 C16142\_HEKLA-SOCKET-K  
 C14658\_BARBARA-RZ-LENS  
 Bender Wirth: 481 Typ L8

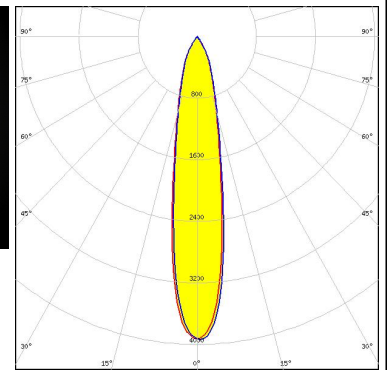
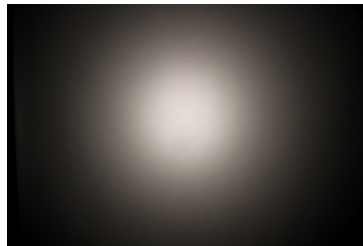

#### CREE LED

LED CMT14xx  
 FWHM / FWTM 15.0° / 30.0°  
 Efficiency 90 %  
 Peak intensity 7.7 cd/lm  
 LEDs/each optic 1  
 Light colour White  
 Required components:  
 F15255\_HEKLA-SOCKET-C

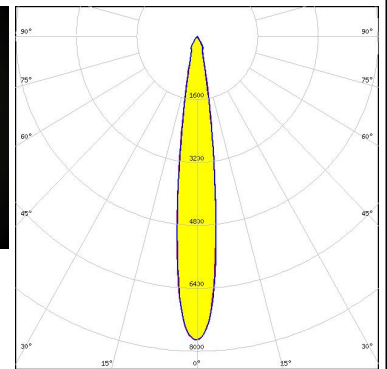
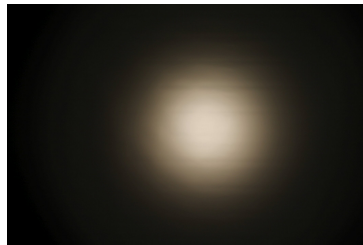



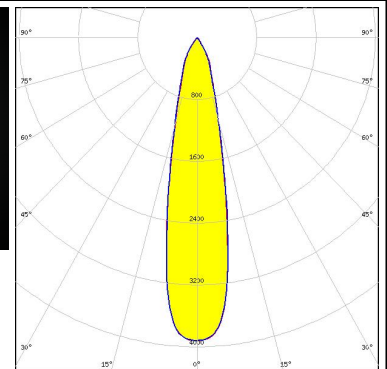
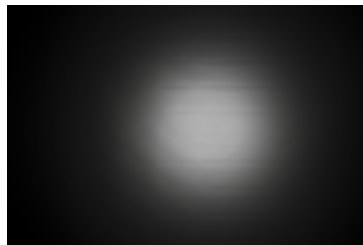

#### CREE LED

LED CMT19xx  
 FWHM / FWTM 22.0° / 52.0°  
 Efficiency 90 %  
 Peak intensity 3.9 cd/lm  
 LEDs/each optic 1  
 Light colour White  
 Required components:  
 F15859\_HEKLA-SOCKET-I

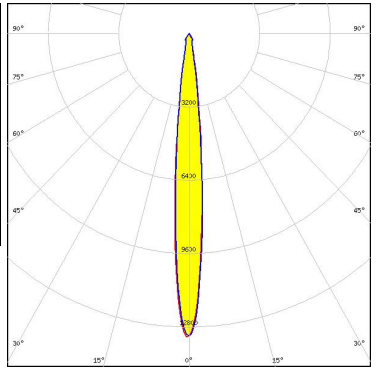

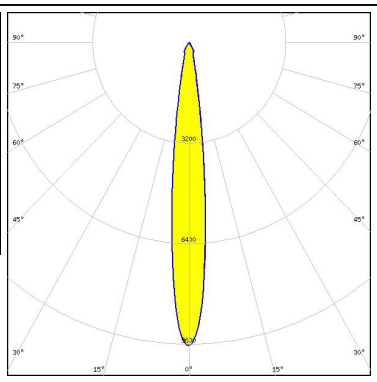

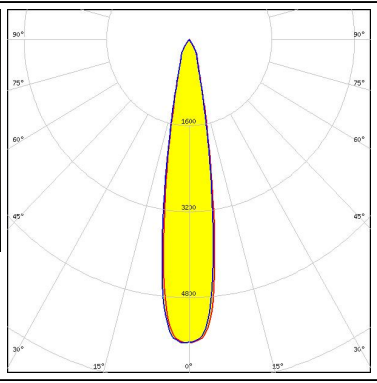
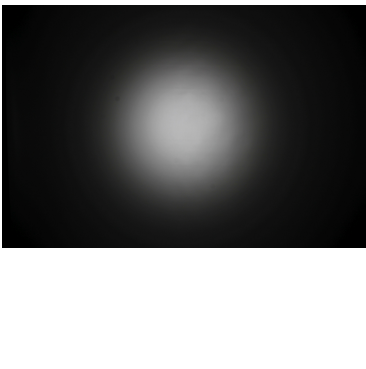
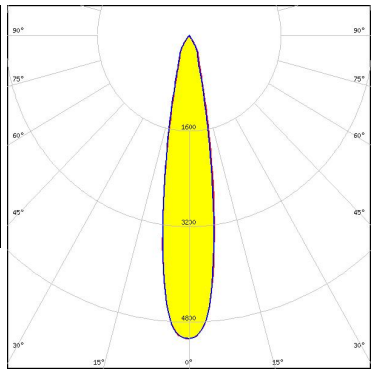

#### OPTICAL RESULTS (MEASURED):



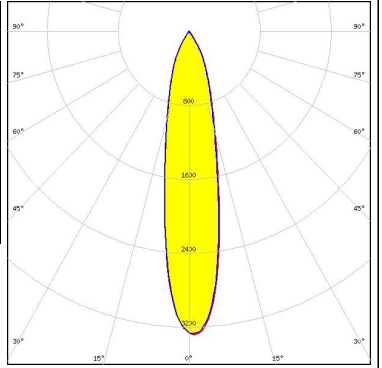

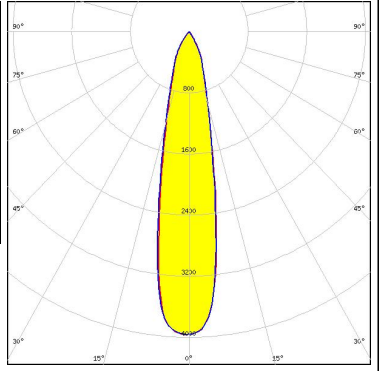

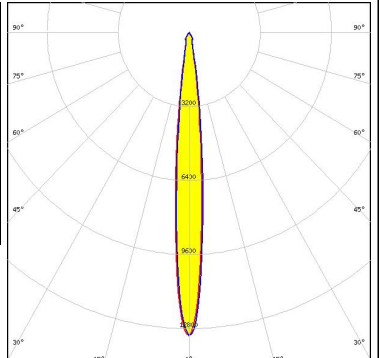
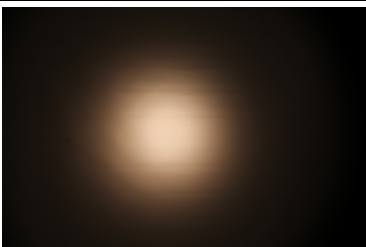
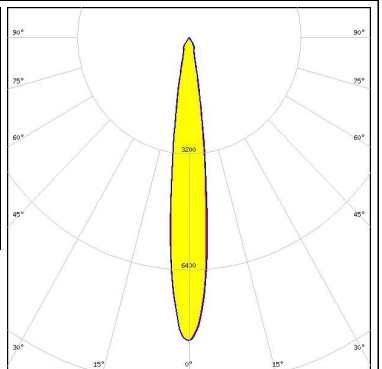
<p><b>CREE</b> → <b>LED</b></p> <p>LED CXA/B 13xx            FWHM / FWTM 11.0° / 23.0°            Efficiency 91 %            Peak intensity 13.1 cd/lm            LEDs/each optic 1            Light colour White            Required components:            F15956_HEKLA-SOCKET-J</p>		
<p><b>CREE</b> → <b>LED</b></p> <p>LED CXA/B 15xx            FWHM / FWTM 13.0° / 27.0°            Efficiency 92 %            Peak intensity 9.7 cd/lm            LEDs/each optic 1            Light colour White            Required components:            F15256_HEKLA-SOCKET-D</p>		
<p><b>CREE</b> → <b>LED</b></p> <p>LED CXA/B 1816 &amp; CXA/B 1820 &amp; CXA 1850            FWHM / FWTM 19.0° / 39.0°            Efficiency 92 %            Peak intensity 5.6 cd/lm            LEDs/each optic 1            Light colour White            Required components:            F15256_HEKLA-SOCKET-D</p>		
<p><b>CREE</b> → <b>LED</b></p> <p>LED CXA/B 1816 &amp; CXA/B 1820 &amp; CXA 1850            FWHM / FWTM 19.0° / 41.0°            Efficiency 89 %            Peak intensity 5.1 cd/lm            LEDs/each optic 1            Light colour White            Required components:            F15254_HEKLA-SOCKET-B</p>		



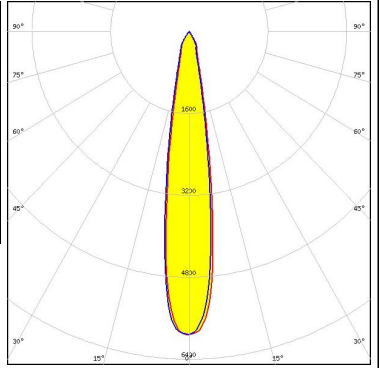

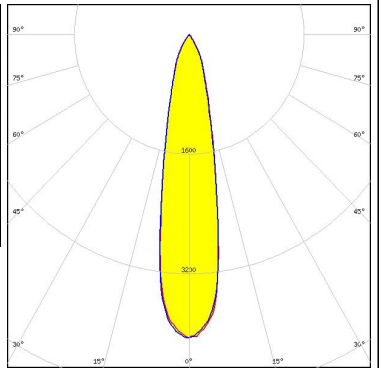

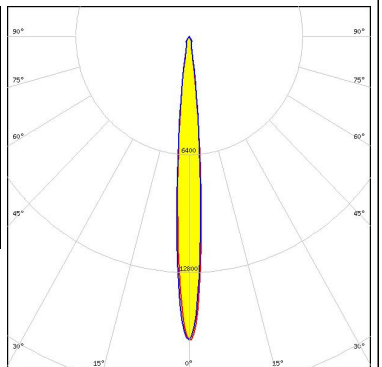

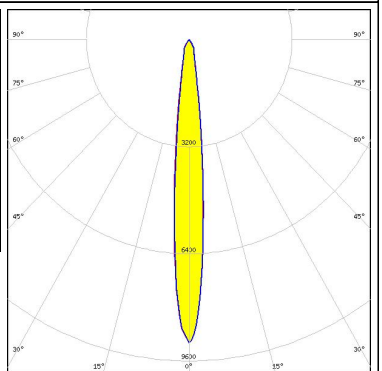
#### OPTICAL RESULTS (MEASURED):

<p><b>LUMILEDS</b></p> <p>LED LUXEON CX Plus CoB L08 (Gen2)</p> <p>FWHM / FWTM 21.0° / 56.0°</p> <p>Efficiency 80 %</p> <p>Peak intensity 3.3 cd/lm</p> <p>LEDs/each optic 1</p> <p>Light colour White</p> <p>Required components: C14658_BARBARA-RZ-LENS Bender Wirth: 637a Hekla</p>		
<p><b>LUMILEDS</b></p> <p>LED LUXEON CX Plus CoB L08 (Gen2)</p> <p>FWHM / FWTM 21.0° / 52.0°</p> <p>Efficiency 88 %</p> <p>Peak intensity 4 cd/lm</p> <p>LEDs/each optic 1</p> <p>Light colour White</p> <p>Required components: Bender Wirth: 637a Hekla</p>		
<p><b>LUMILEDS</b></p> <p>LED LUXEON CoB 1202HD</p> <p>FWHM / FWTM 10.0° / 22.0°</p> <p>Efficiency 90 %</p> <p>Peak intensity 13.2 cd/lm</p> <p>LEDs/each optic 1</p> <p>Light colour White</p> <p>Required components: F15848_HEKLA-SOCKET-G</p>		
<p><b>LUMILEDS</b></p> <p>LED LUXEON CoB 1204HD</p> <p>FWHM / FWTM 14.0° / 29.0°</p> <p>Efficiency 90 %</p> <p>Peak intensity 8.4 cd/lm</p> <p>LEDs/each optic 1</p> <p>Light colour White</p> <p>Required components: F15858_HEKLA-SOCKET-H</p>		

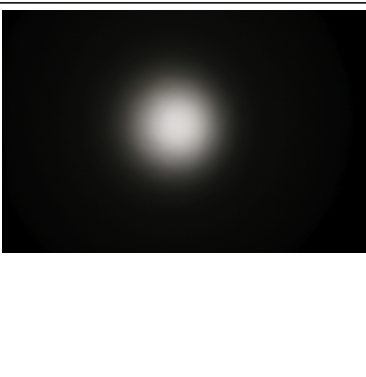
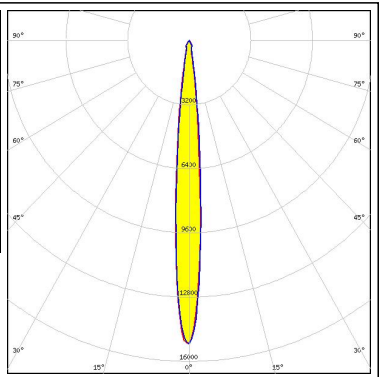

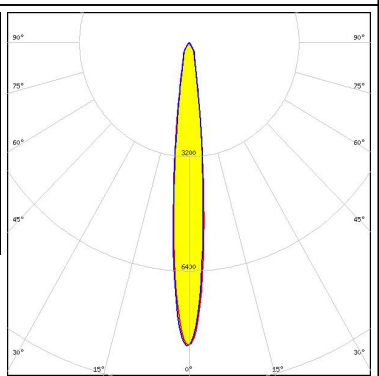

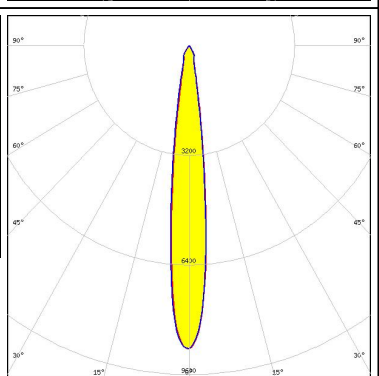

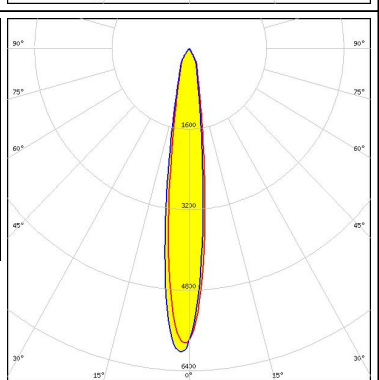
#### OPTICAL RESULTS (MEASURED):

<p><b>LUMILEDS</b></p> <p>LED LUXEON CoB 1205HD</p> <p>FWHM / FWTM 17.0° / 37.0°</p> <p>Efficiency 89 %</p> <p>Peak intensity 6 cd/m</p> <p>LEDs/each optic 1</p> <p>Light colour White</p> <p>Required components: F15858_HEKLA-SOCKET-H</p>		
<p><b>LUMILEDS</b></p> <p>LED LUXEON CoB 1208</p> <p>FWHM / FWTM 22.0° / 51.0°</p> <p>Efficiency 88 %</p> <p>Peak intensity 4.1 cd/m</p> <p>LEDs/each optic 1</p> <p>Light colour White</p> <p>Required components: Bender Wirth: 632a Hekla XL</p>		
<p><b>LUMILEDS</b></p> <p>LED LUXEON CX Plus CoB - HD S01H4</p> <p>FWHM / FWTM 9.0° / 20.0°</p> <p>Efficiency 89 %</p> <p>Peak intensity 16.4 cd/m</p> <p>LEDs/each optic 1</p> <p>Light colour White</p> <p>Required components: Bender Wirth: 634c Hekla</p>		
<p><b>LUMILEDS</b></p> <p>LED LUXEON CX Plus CoB - HD S01H4</p> <p>FWHM / FWTM 11.0° / 27.0°</p> <p>Efficiency 83 %</p> <p>Peak intensity 9.1 cd/m</p> <p>LEDs/each optic 1</p> <p>Light colour White</p> <p>Required components: C14658_BARBARA-RZ-LENS Bender Wirth: 634c Hekla</p>		

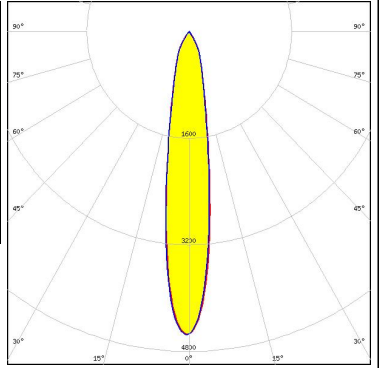

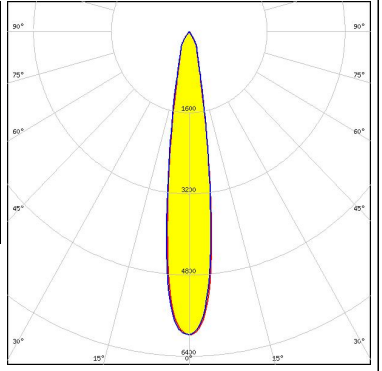
#### OPTICAL RESULTS (MEASURED):

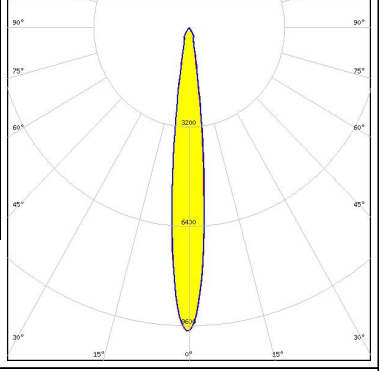
<p><b>LUMILEDS</b></p> <p>LED LUXEON CX Plus CoB - HD S01H6 / HD S02H6</p> <p>FWHM / FWTM 10.0° / 21.0°</p> <p>Efficiency 89 %</p> <p>Peak intensity 15.1 cd/m</p> <p>LEDs/each optic 1</p> <p>Light colour White</p> <p>Required components: Bender Wirth: 634c Hekla</p>		
<p><b>LUMILEDS</b></p> <p>LED LUXEON CX Plus CoB - HD S01H6 / HD S02H6</p> <p>FWHM / FWTM 12.0° / 29.0°</p> <p>Efficiency 83 %</p> <p>Peak intensity 8.5 cd/m</p> <p>LEDs/each optic 1</p> <p>Light colour White</p> <p>Required components: C14658_BARBARA-RZ-LENS Bender Wirth: 634c Hekla</p>		
<p><b>LUMILEDS</b></p> <p>LED LUXEON CX Plus CoB - HD S04H9</p> <p>FWHM / FWTM 13.0° / 28.0°</p> <p>Efficiency 89 %</p> <p>Peak intensity 8.9 cd/m</p> <p>LEDs/each optic 1</p> <p>Light colour White</p> <p>Required components: Bender Wirth: 634c Hekla</p>		
<p><b>LUMILEDS</b></p> <p>LED LUXEON CX Plus CoB - HD S04H9</p> <p>FWHM / FWTM 15.0° / 37.0°</p> <p>Efficiency 83 %</p> <p>Peak intensity 6.1 cd/m</p> <p>LEDs/each optic 1</p> <p>Light colour White</p> <p>Required components: C14658_BARBARA-RZ-LENS Bender Wirth: 634c Hekla</p>		

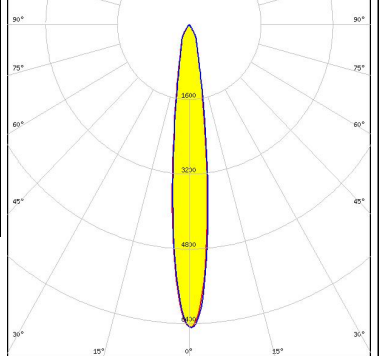
#### OPTICAL RESULTS (MEASURED):

<p><b>LUMILEDS</b></p> <p>LED LUXEON CX Plus CoB L04 / L05 (Gen2)</p> <p>FWHM / FWTM 17.0° / 47.0°</p> <p>Efficiency 82 %</p> <p>Peak intensity 4.6 cd/m</p> <p>LEDs/each optic 1</p> <p>Light colour White</p> <p>Required components: C14658_BARBARA-RZ-LENS Bender Wirth: 637a Hekla</p>		
<p><b>LUMILEDS</b></p> <p>LED LUXEON CX Plus CoB L04 / L05 (Gen2)</p> <p>FWHM / FWTM 17.0° / 38.0°</p> <p>Efficiency 88 %</p> <p>Peak intensity 6 cd/m</p> <p>LEDs/each optic 1</p> <p>Light colour White</p> <p>Required components: Bender Wirth: 637a Hekla</p>		
<p><b>LUMILEDS</b></p> <p>LED LUXEON CX Plus CoB M02 / M03 (Gen2)</p> <p>FWHM / FWTM 12.0° / 26.0°</p> <p>Efficiency 89 %</p> <p>Peak intensity 9.8 cd/m</p> <p>LEDs/each optic 1</p> <p>Light colour White</p> <p>Required components: Bender Wirth: 641a Hekla</p>		
<p><b>LUMILEDS</b></p> <p>LED LUXEON CX Plus CoB M02 / M03 (Gen2)</p> <p>FWHM / FWTM 14.0° / 35.0°</p> <p>Efficiency 82 %</p> <p>Peak intensity 6.5 cd/m</p> <p>LEDs/each optic 1</p> <p>Light colour White</p> <p>Required components: C14658_BARBARA-RZ-LENS Bender Wirth: 641a Hekla</p>		

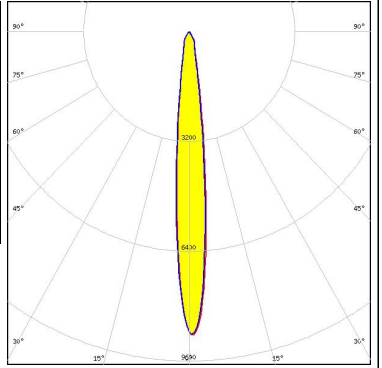
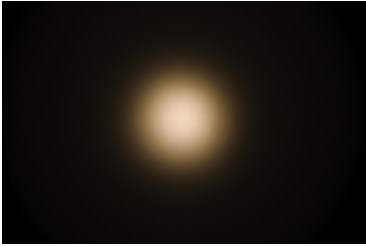
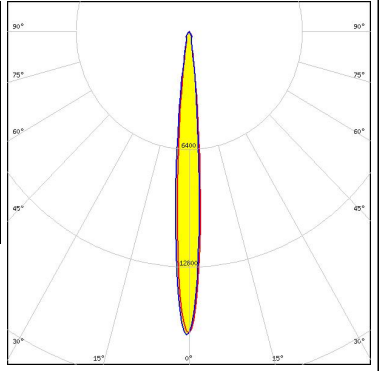
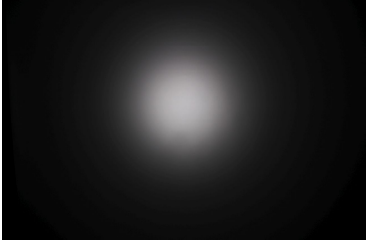
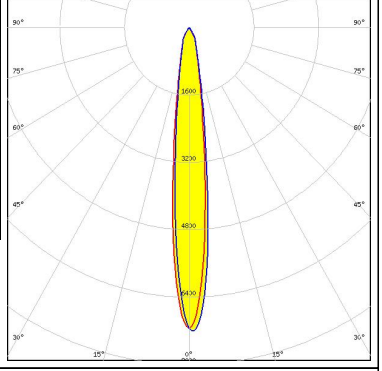
#### OPTICAL RESULTS (MEASURED):

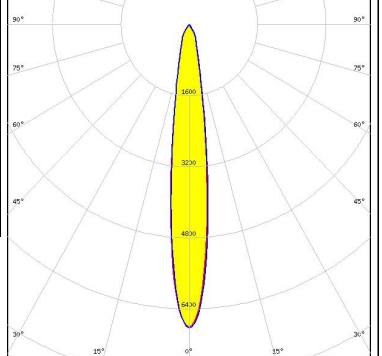
<p><b>LUMILEDS</b></p> <p>LED LUXEON CX Plus CoB S01 (Gen2)</p> <p>FWHM / FWTM 11.0° / 27.0°</p> <p>Efficiency 82 %</p> <p>Peak intensity 9 cd/lm</p> <p>LEDs/each optic 1</p> <p>Light colour White</p> <p>Required components: C14658_BARBARA-RZ-LENS Bender Wirth: 634c Hekla</p>		
<p><b>LUMILEDS</b></p> <p>LED LUXEON CX Plus CoB S01 (Gen2)</p> <p>FWHM / FWTM 9.0° / 19.0°</p> <p>Efficiency 89 %</p> <p>Peak intensity 16.5 cd/lm</p> <p>LEDs/each optic 1</p> <p>Light colour White</p> <p>Required components: Bender Wirth: 634c Hekla</p>		
<p><b>LUMILEDS</b></p> <p>LED LUXEON Fusion 21-up (20x24)</p> <p>FWHM / FWTM 13.0° / 33.0°</p> <p>Efficiency 82 %</p> <p>Peak intensity 7.2 cd/lm</p> <p>LEDs/each optic 21</p> <p>Light colour White</p> <p>Required components: C16142_HEKLA-SOCKET-K C14658_BARBARA-RZ-LENS Bender Wirth: 442 Typ L8</p>		
<p><b>PHILIPS</b></p> <p>LED Fortimo SLM L09 CoB</p> <p>FWHM / FWTM 14.0° / 35.0°</p> <p>Efficiency 87 %</p> <p>Peak intensity 6.8 cd/lm</p> <p>LEDs/each optic 1</p> <p>Light colour White</p> <p>Required components: F15858_HEKLA-SOCKET-H C14658_BARBARA-RZ-LENS</p>		

#### OPTICAL RESULTS (MEASURED):

### PHILIPS

LED Fortimo SLM L09 CoB  
 FWHM / FWTM 14.0° / 28.0°  
 Efficiency 91 %  
 Peak intensity 9 cd/lm  
 LEDs/each optic 1  
 Light colour White  
 Required components:  
 F15858\_HEKLA-SOCKET-H

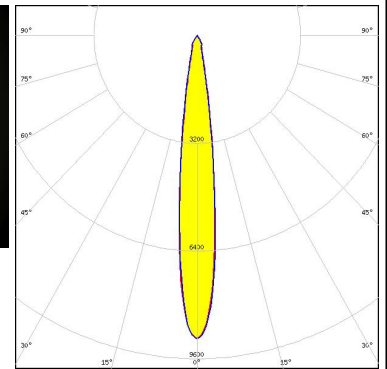
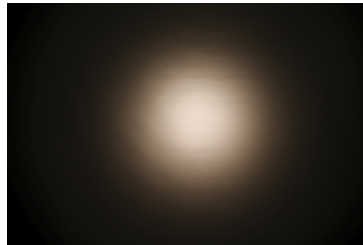

### PHILIPS

LED Fortimo SLM L13 CoB  
 FWHM / FWTM 20.0° / 48.0°  
 Efficiency 87 %  
 Peak intensity 4.4 cd/lm  
 LEDs/each optic 1  
 Light colour White  
 Required components:  
 C16142\_HEKLA-SOCKET-K  
 Bender Wirth: 432 Typ L8

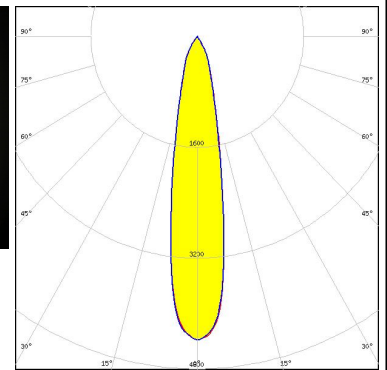
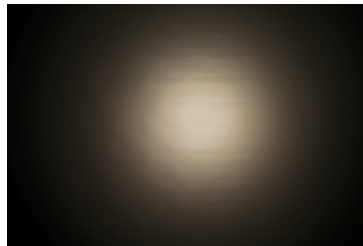

### PHILIPS

LED Fortimo SLM L13 CoB  
 FWHM / FWTM 20.0° / 54.0°  
 Efficiency 82 %  
 Peak intensity 3.6 cd/lm  
 LEDs/each optic 1  
 Light colour White  
 Required components:  
 C16142\_HEKLA-SOCKET-K  
 C14658\_BARBARA-RZ-LENS  
 Bender Wirth: 432 Typ L8

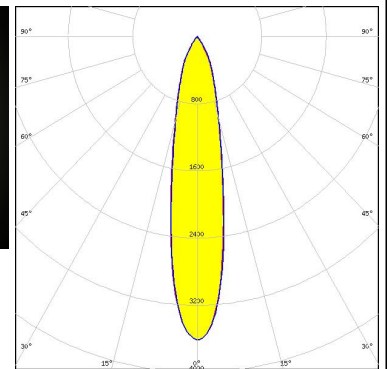
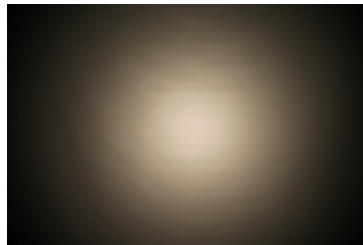

### PHILIPS

LED Fortimo SLM L15 CoB  
 FWHM / FWTM 23.0° / 55.0°  
 Efficiency 86 %  
 Peak intensity 3.5 cd/lm  
 LEDs/each optic 1  
 Light colour White  
 Required components:  
 C16142\_HEKLA-SOCKET-K  
 Bender Wirth: 432 Typ L8

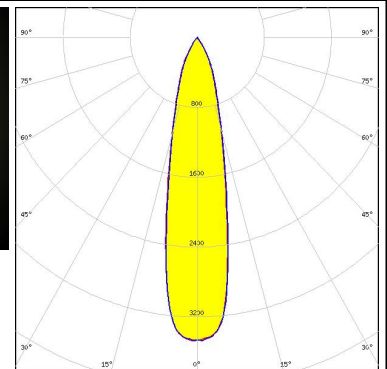
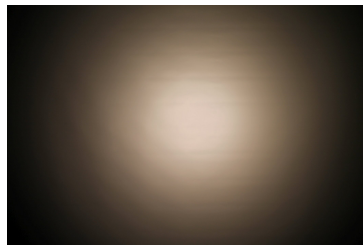

#### OPTICAL RESULTS (MEASURED):

### PHILIPS

LED Fortimo SLM L15 CoB  
 FWHM / FWTM 23.0° / 57.0°  
 Efficiency 81 %  
 Peak intensity 3 cd/lm  
 LEDs/each optic 1  
 Light colour White  
 Required components:  
 C16142\_HEKLA-SOCKET-K  
 C14658\_BARBARA-RZ-LENS  
 Bender Wirth: 432 Typ L8

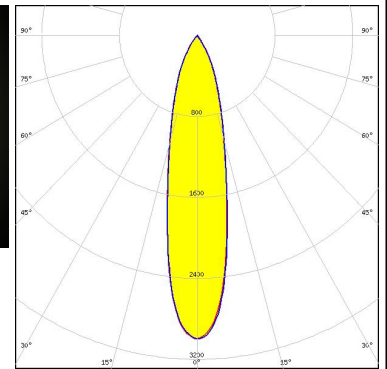
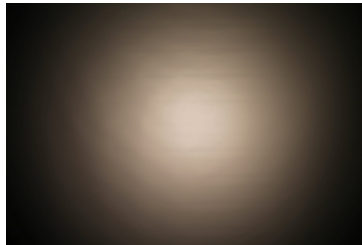

### SAMSUNG

LED LC003D / LC006D / LC009D / LC013D  
 FWHM / FWTM 14.0° / 29.0°  
 Efficiency 90 %  
 Peak intensity 8.4 cd/lm  
 LEDs/each optic 1  
 Light colour White  
 Required components:  
 F15255\_HEKLA-SOCKET-C

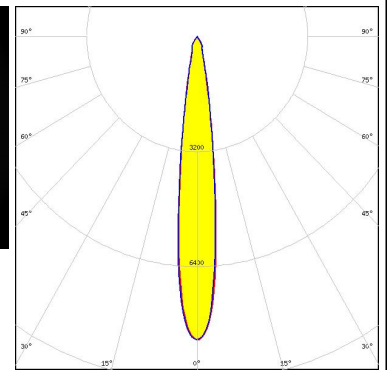

### SAMSUNG

LED LC003D / LC006D / LC009D / LC013D  
 FWHM / FWTM 15.0° / 31.0°  
 Efficiency 90 %  
 Peak intensity 7.7 cd/lm  
 LEDs/each optic 1  
 Light colour White  
 Required components:  
 F15255\_HEKLA-SOCKET-C

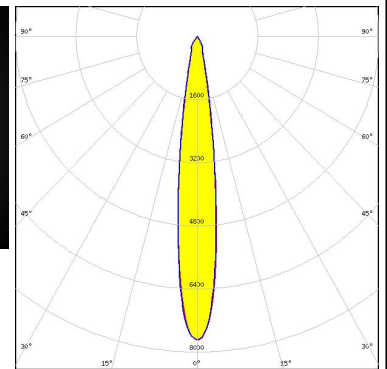

### SAMSUNG

LED LC010C G2  
 FWHM / FWTM 10.0° / 22.0°  
 Efficiency 90 %  
 Peak intensity 13.8 cd/lm  
 LEDs/each optic 1  
 Light colour White  
 Required components:  
 F15255\_HEKLA-SOCKET-C

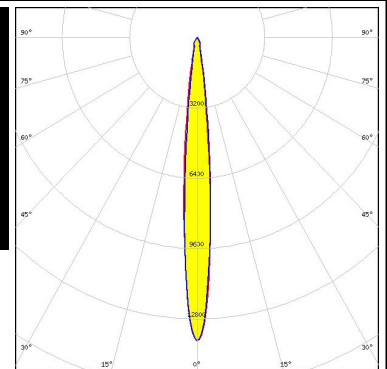

#### OPTICAL RESULTS (MEASURED):

### SAMSUNG

LED LC020T (Tunable white)  
 FWHM / FWTM 19.0° / 44.0°  
 Efficiency 87 %  
 Peak intensity 4.9 cd/lm  
 LEDs/each optic 1  
 Light colour Tunable White  
 Required components:  
 C16142\_HEKLA-SOCKET-K  
 Bender Wirth: 501 Typ L8

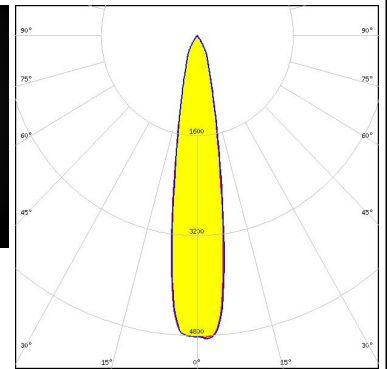
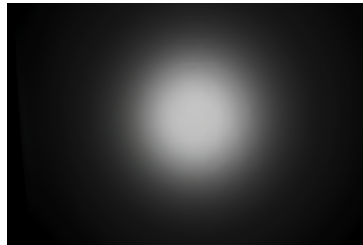

### SAMSUNG

LED LC020T (Tunable white)  
 FWHM / FWTM 19.0° / 50.0°  
 Efficiency 82 %  
 Peak intensity 4.1 cd/lm  
 LEDs/each optic 1  
 Light colour Tunable White  
 Required components:  
 C16142\_HEKLA-SOCKET-K  
 C14658\_BARBARA-RZ-LENS  
 Bender Wirth: 501 Typ L8

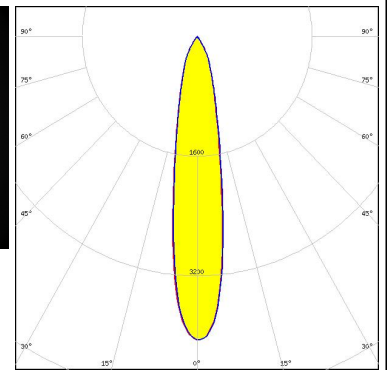

### TRIDONIC

LED SLE G7 LES09  
 FWHM / FWTM 14.0° / 29.0°  
 Efficiency 92 %  
 Peak intensity 8.7 cd/lm  
 LEDs/each optic 1  
 Light colour White  
 Required components:  
 F15255\_HEKLA-SOCKET-C

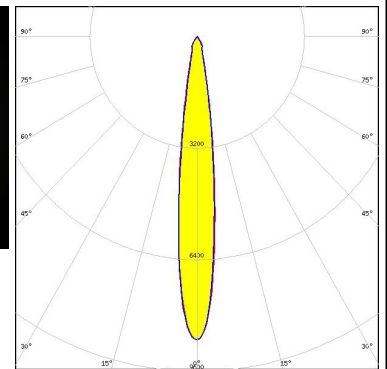

### TRIDONIC

LED SLE G7 LES09  
 FWHM / FWTM 14.0° / 35.0°  
 Efficiency 88 %  
 Peak intensity 6.7 cd/lm  
 LEDs/each optic 1  
 Light colour White  
 Required components:  
 F15255\_HEKLA-SOCKET-C  
 C14658\_BARBARA-RZ-LENS

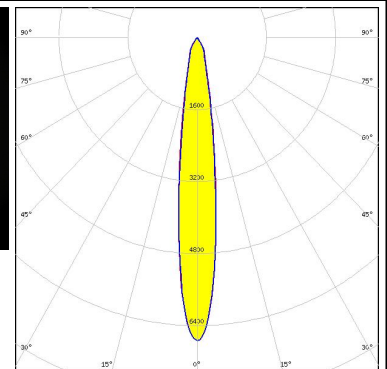



#### OPTICAL RESULTS (MEASURED):

#### TRIDONIC

LED SLE G7 LES13  
 FWHM / FWTM 20.0° / 45.0°  
 Efficiency 89 %  
 Peak intensity 4.6 cd/lm  
 LEDs/each optic 1  
 Light colour White  
 Required components:  
 F15859\_HEKLA-SOCKET-I

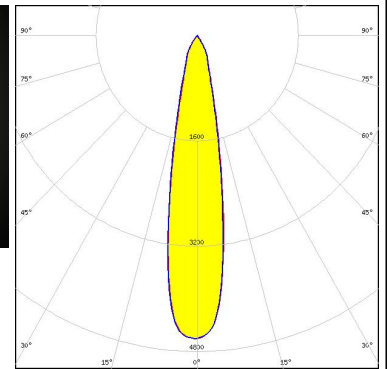

#### TRIDONIC

LED SLE G7 LES13  
 FWHM / FWTM 20.0° / 43.0°  
 Efficiency 92 %  
 Peak intensity 5 cd/lm  
 LEDs/each optic 1  
 Light colour White  
 Required components:  
 F15859\_HEKLA-SOCKET-I

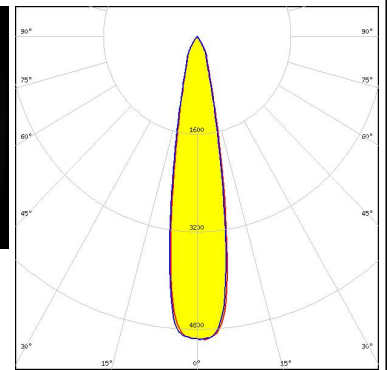
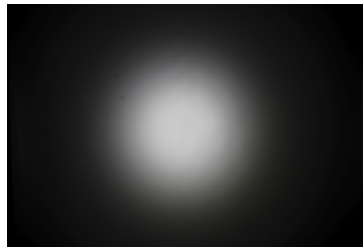

#### TRIDONIC

LED SLE G7 LES13  
 FWHM / FWTM 20.0° / 54.0°  
 Efficiency 82 %  
 Peak intensity 3.7 cd/lm  
 LEDs/each optic 1  
 Light colour White  
 Required components:  
 F15859\_HEKLA-SOCKET-I  
 C14658\_BARBARA-RZ-LENS

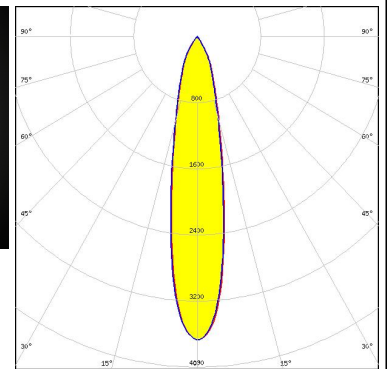
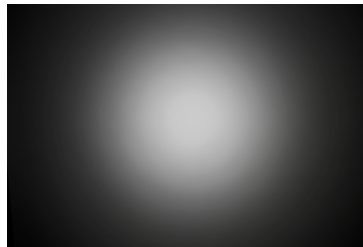

#### TRIDONIC

LED SLE G7 LES15  
 FWHM / FWTM 23.0° / 53.0°  
 Efficiency 89 %  
 Peak intensity 3.8 cd/lm  
 LEDs/each optic 1  
 Light colour White  
 Required components:  
 F15859\_HEKLA-SOCKET-I

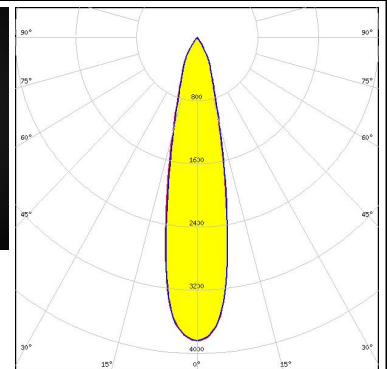
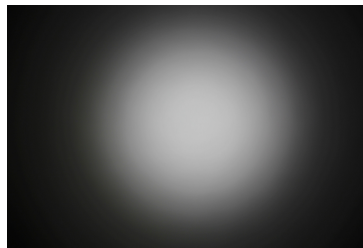

#### OPTICAL RESULTS (MEASURED):

#### XICATO

LED XOB 14.5 mm  
 FWHM / FWTM 21.0° / 48.0°  
 Efficiency 91 %  
 Peak intensity 4.3 cd/lm  
 LEDs/each optic 1  
 Light colour White  
 Required components:  
 F15859\_HEKLA-SOCKET-I

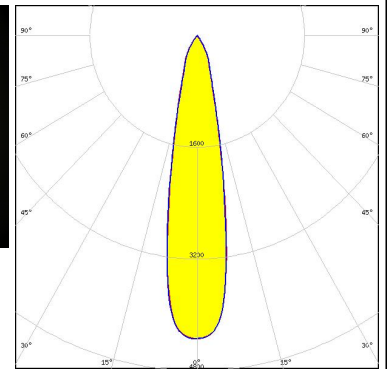
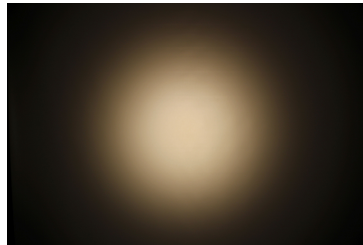

#### XICATO

LED XOB 6 mm  
 FWHM / FWTM 9.0° / 20.0°  
 Efficiency 89 %  
 Peak intensity 16 cd/lm  
 LEDs/each optic 1  
 Light colour White  
 Required components:  
 F15255\_HEKLA-SOCKET-C

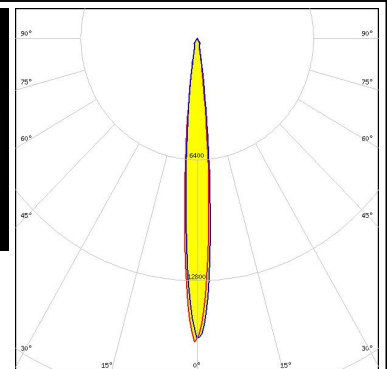

#### XICATO

LED XOB 6 mm  
 FWHM / FWTM 11.0° / 27.0°  
 Efficiency 85 %  
 Peak intensity 9.5 cd/lm  
 LEDs/each optic 1  
 Light colour White  
 Required components:  
 F15255\_HEKLA-SOCKET-C  
 C14658\_BARBARA-RZ-LENS

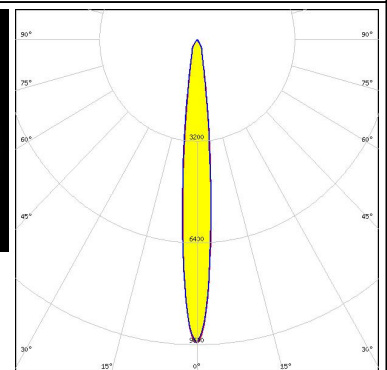

#### XICATO

LED XOB 9.8 mm  
 FWHM / FWTM 13.0° / 27.5 + 27.0°  
 Efficiency 90 %  
 Peak intensity 9.4 cd/lm  
 LEDs/each optic 1  
 Light colour White  
 Required components:  
 F15255\_HEKLA-SOCKET-C

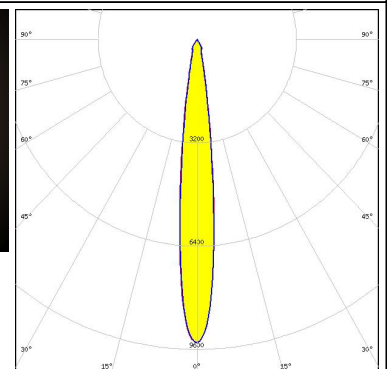

#### OPTICAL RESULTS (MEASURED):

### XICATO

LED	XOB 9.8 mm
FWHM / FWTM	14.0° / 35.5 + 34.5°
Efficiency	86 %
Peak intensity	6.8 cd/lm
LEDs/each optic	1
Light colour	White

Required components:  
F15255\_HEKLA-SOCKET-C  
C14658\_BARBARA-RZ-LENS

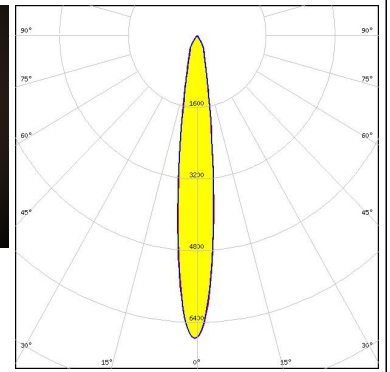

#### OPTICAL RESULTS (SIMULATED):

<p><b>bridgelux.</b></p> <p>LED: V13 Gen 8            FWHM / FWTM: 22.0° / 50.0°            Efficiency: 88 %            Peak intensity: 4 cd/lm            LEDs/each optic: 1            Light colour: White            Required components:            F17438_HEKLA-G2-I</p>	
<p><b>bridgelux.</b></p> <p>LED: Vesta DTW 15mm (33W)            FWHM / FWTM: 16.0° / 38.0°            Efficiency: 86 %            Peak intensity: 6.1 cd/lm            LEDs/each optic: 1            Light colour: White            Required components:            C16142_HEKLA-SOCKET-K            Bender Wirth: 491 Typ L8</p>	
<p><b>LUMILEDS</b></p> <p>LED: LUXEON CoB 1208            FWHM / FWTM: 21.0° / 49.0°            Efficiency: 86 %            Peak intensity: 4.1 cd/lm            LEDs/each optic: 1            Light colour: White            Required components:            C16142_HEKLA-SOCKET-K</p>	
<p><b>NICHIA</b></p> <p>LED: COB L-Type (LES 11)            FWHM / FWTM: 18.0° / 38.0°            Efficiency: 89 %            Peak intensity: 5.7 cd/lm            LEDs/each optic: 1            Light colour: White            Required components:            F15858_HEKLA-SOCKET-H</p>	

#### OPTICAL RESULTS (SIMULATED):



LED	COB L-Type (LES 9)
FWHM / FWTM	14.0° / 29.0°
Efficiency	89 %
Peak intensity	8.9 cd/lm
LEDs/each optic	1
Light colour	White
Required components:	
	F15858_HEKLA-SOCKET-H

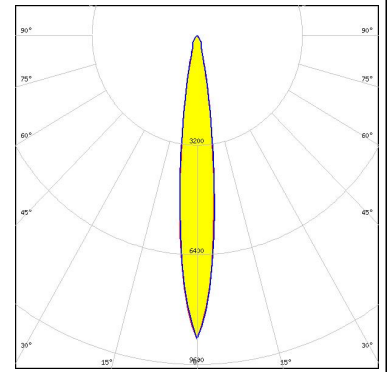

### GENERAL INFORMATION:

NOTE: The typical beam angle will be changed by different color, chip size and chip position tolerance. The typical total beam angle is the full angle measured where the luminous intensity is half of the peak value.

Due to use of high power COB's with this product, special attention to proper thermal design is highly recommended. LEDiL has no liability for direct, indirect or consecutive damages arising from the LEDiL products being used outside of the recommended temperature range.

### MATERIALS:

As part of our continuous research and improvement processes, and to ensure the best possible quality and availability of our products, LEDiL reserves the right to change material grades without notice.

### PRODUCT DATA USER AGREEMENT AND DISCLAIMER:

The measured data in the provided downloadable LEDiL Product Datasheets and Mechanical 2D-Drawings is rounded and provided as reference for planning. LEDiL Oy's optical specifications have been verified by conducting performance testing of the products in accordance with the company's quality system. The reported data are averaged results of multiple measurements with typical variation. LEDiL Oy reserves the right to without prior notification make changes and improvements to its products.

LEDiL Oy assumes neither warranty, nor guarantee nor any other liability of any kind for the contents and correctness of the provided data. The provided data has been generated with highest diligence but the provided data may in reality not represent the complete possible variation range of all intrinsic parameters. Therefore, in certain cases a deviation from the provided data could occur.

LEDiL Oy reserves the right to undertake technical changes of its products without further notification which could lead to changes in the provided data. LEDiL Oy assumes no liability of any kind for the possible deviation from any provided data or any other damage resulting from the usage of the provided data.

The user agrees to this disclaimer and user agreement with the download or usage of the provided files.

#### LEDiL Oy

Joensuunkatu 13  
FI-24240 SALO  
Finland

#### LEDiL Inc.

228 West Page Street  
Suite D  
Sycamore IL 60178  
USA

#### Ledil Optics Technology (Shenzhen) Co., Ltd.

# 405 , Block B  
Casic Motor Building  
Shenzhen 518057  
P.R.CHINA

#### Local sales and technical support

[www.ledil.com/  
where\\_to\\_buy](http://www.ledil.com/where_to_buy)

#### Shipping locations

Salo, Finland  
Hong Kong, China

#### Distribution Partners

[www.ledil.com/  
where\\_to\\_buy](http://www.ledil.com/where_to_buy)