

HEIDI-O-90

~13° x 45° oval beam optimized for Luxeon Rebel. Variant with beam direction rotated 90°.

SPECIFICATION:

Dimensions	Ø 21.6 mm
Height	11.7 mm
Fastening	tape, pin
ROHS compliant	yes ⓘ

MATERIALS:

Component	Type	Material	Colour	Finish
HEIDI-O-90	Single lens	PMMA	clear	
HEIDI-TAPE	Tape	Acrylic foam	black	

ORDERING INFORMATION:

Component	Type	Qty in box	MOQ	MPQ	Box weight (kg)
CA12815_HEIDI-O-90 » Box size: 480 x 280 x 300 mm	Single lens	3264	204	204	11.1



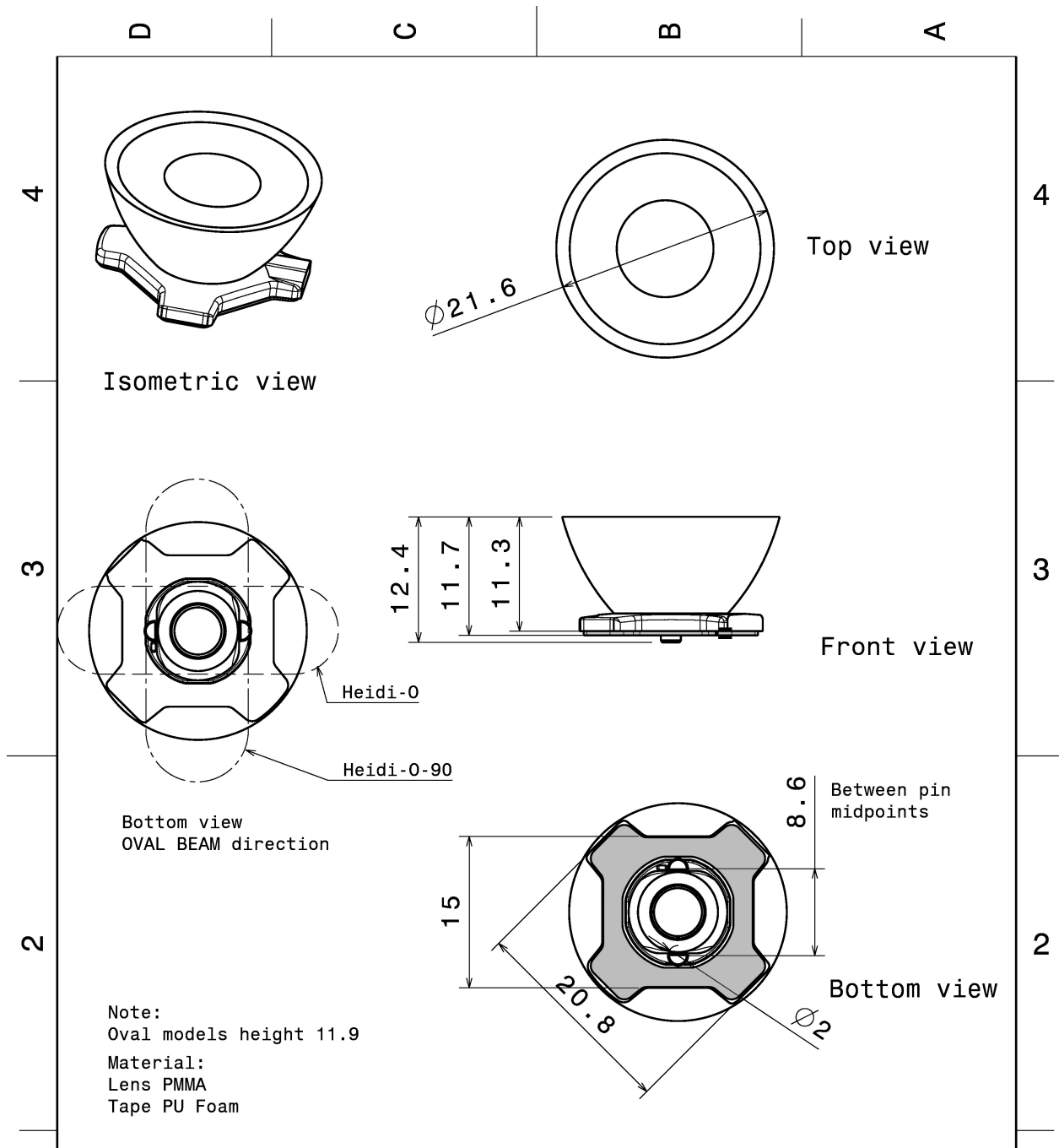

This drawing is our property. It can't be reproduced or communicated without our written agreement.				Ledil Oy Joensuunkatu 13 FIN-24100 SALO Finland	
DRAWN BY ah		DATE 1.2.2012		DRAWING TITLE Datasheet Heidi-Series Assy	
CHECKED BY		DATE		SIZE A4	
DESIGNED BY		DATE		DRAWING NUMBER	
		SCALE 2:1		WEIGHT (g)	
				REV 2	
				SHEET 1/1	

See also our general installation guide: www.ledil.com/installation_guide

OPTICAL RESULTS (MEASURED):

CREE LED

LED XHP35 HD
 FWHM / FWTM 17.0 + 38.0° / 44.0 + 68.0°
 Efficiency 84 %
 Peak intensity 3.2 cd/lm
 LEDs/each optic 1
 Light colour White
 Required components:



CREE LED

LED XHP35 HI
 FWHM / FWTM 13.0 + 47.0° / 36.0 + 73.0°
 Efficiency 94 %
 Peak intensity 3.4 cd/lm
 LEDs/each optic 1
 Light colour White
 Required components:

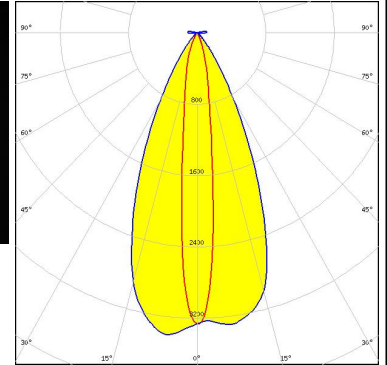

CREE LED

LED XP-L HD
 FWHM / FWTM 16.0 + 40.0° / 38.0 + 63.0°
 Efficiency 88 %
 Peak intensity 3.6 cd/lm
 LEDs/each optic 1
 Light colour White
 Required components:

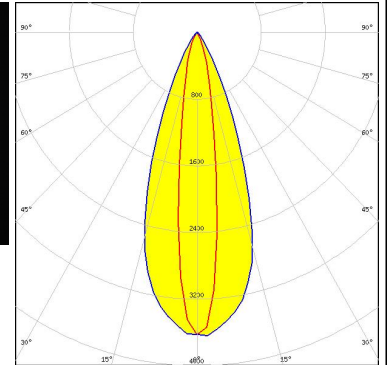
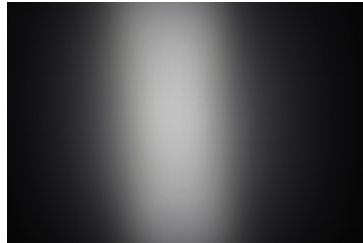



LUMILEDS

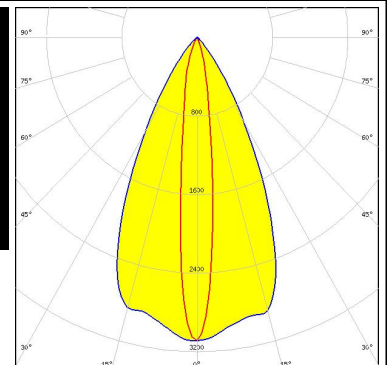
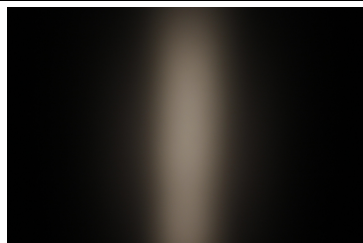



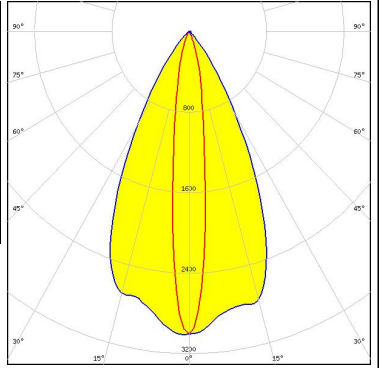

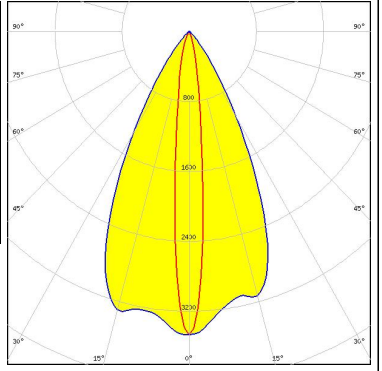
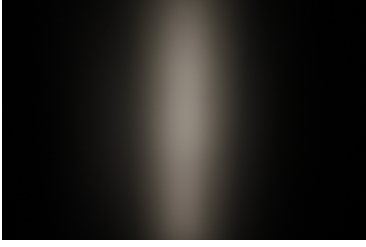
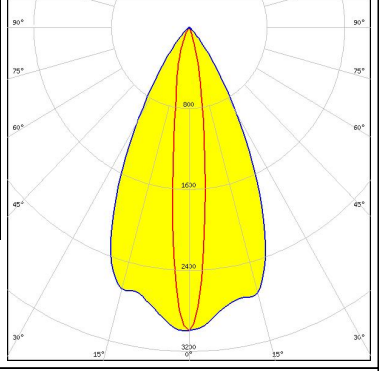
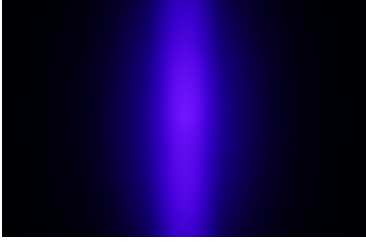
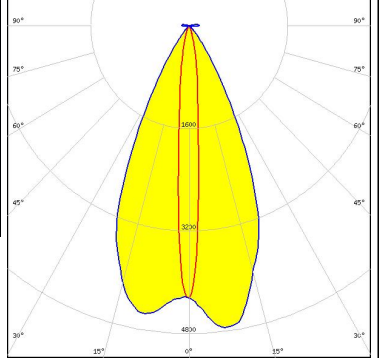
LED LUXEON A
 FWHM / FWTM 14.0 + 54.0° / 34.0 + 79.0°
 Efficiency 82 %
 Peak intensity 3.1 cd/lm
 LEDs/each optic 1
 Light colour White
 Required components:



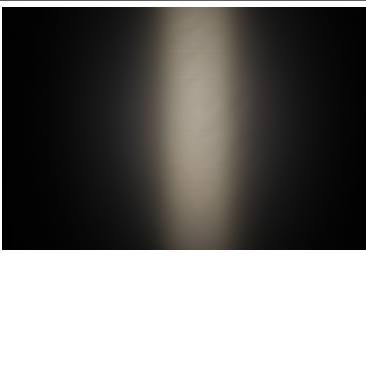
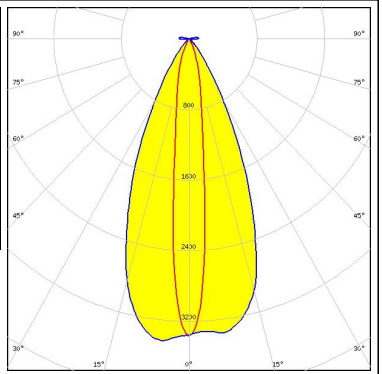

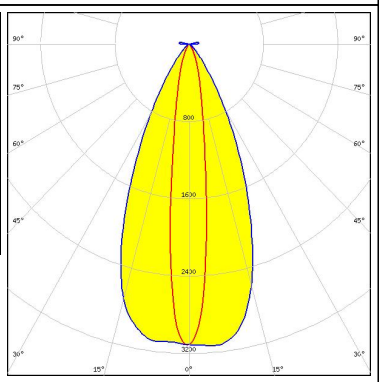
OPTICAL RESULTS (MEASURED):

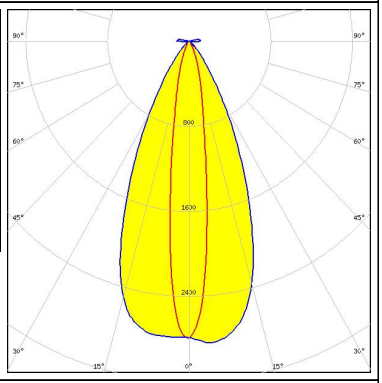
<p>LUMILEDS</p> <p>LED LUXEON R</p> <p>FWHM / FWTM 13.0 + 54.0° / 35.0 + 78.0°</p> <p>Efficiency 82 %</p> <p>Peak intensity 3 cd/lm</p> <p>LEDs/each optic 1</p> <p>Light colour White</p> <p>Required components:</p>		
<p>LUMILEDS</p> <p>LED LUXEON Rebel</p> <p>FWHM / FWTM 12.0 + 54.0° / 30.0 + 78.0°</p> <p>Efficiency 82 %</p> <p>Peak intensity 3.5 cd/lm</p> <p>LEDs/each optic 1</p> <p>Light colour White</p> <p>Required components:</p>		
<p>LUMILEDS</p> <p>LED LUXEON Rebel ES</p> <p>FWHM / FWTM 13.0 + 53.0° / 35.0 + 79.0°</p> <p>Efficiency 81 %</p> <p>Peak intensity 3 cd/lm</p> <p>LEDs/each optic 1</p> <p>Light colour White</p> <p>Required components:</p>		
<p>LUMINUS</p> <p>LED SST-10-B130</p> <p>FWHM / FWTM 9.0 + 49.0° / 27.0 + 71.0°</p> <p>Efficiency 93 %</p> <p>Peak intensity 4.7 cd/lm</p> <p>LEDs/each optic 1</p> <p>Light colour Blue</p> <p>Required components:</p>		

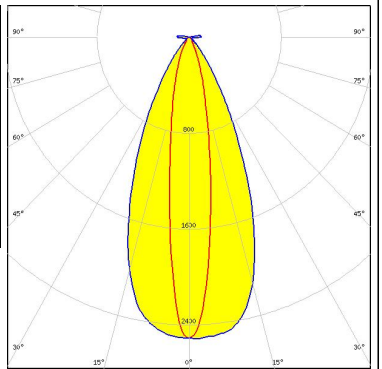
OPTICAL RESULTS (MEASURED):

<p>NICHIA</p> <p>LED NVSW219D FWHM / FWTM 12.0 + 46.0° / 37.0 + 73.0° Efficiency 94 % Peak intensity 3.4 cd/lm LEDs/each optic 1 Light colour White Required components:</p>		
<p>NICHIA</p> <p>LED NVSW319B FWHM / FWTM 14.0 + 47.0° / 37.0 + 74.0° Efficiency 94 % Peak intensity 3.1 cd/lm LEDs/each optic 1 Light colour White Required components:</p>		
<p>NICHIA</p> <p>LED NVSW3x9A FWHM / FWTM 15.0 + 47.0° / 38.0 + 75.0° Efficiency 90 % Peak intensity 2.8 cd/lm LEDs/each optic 1 Light colour White Required components:</p>		
<p>NICHIA</p> <p>LED NVSW519A FWHM / FWTM 16.0 + 46.0° / 44.0 + 76.0° Efficiency 90 % Peak intensity 2.5 cd/lm LEDs/each optic 1 Light colour White Required components:</p>		

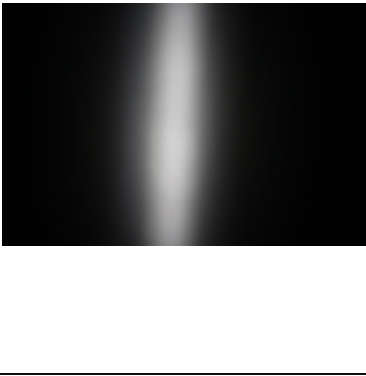
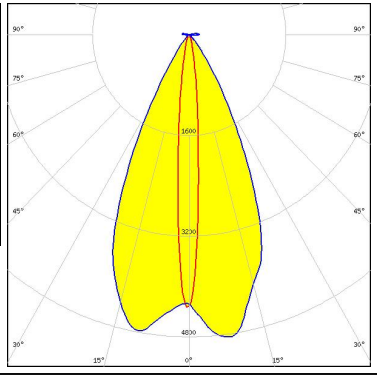
OPTICAL RESULTS (MEASURED):

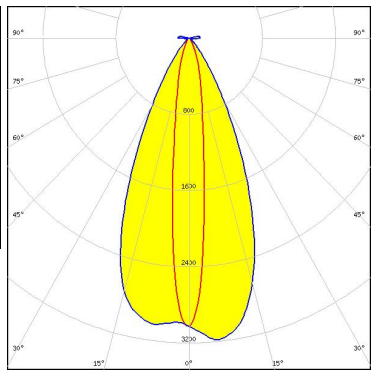
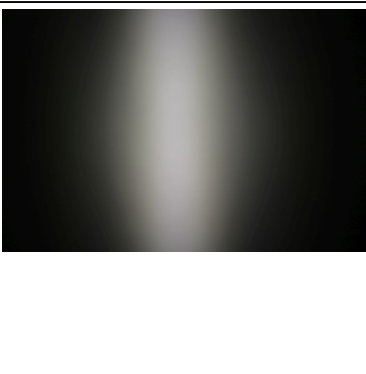
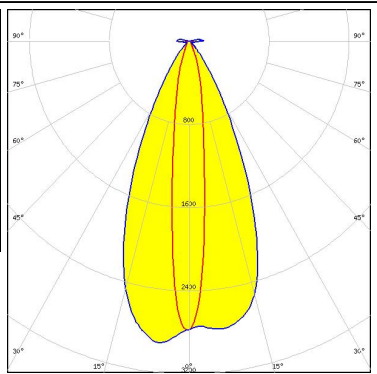
<p>OSRAM Opto Semiconductors</p> <p>LED OSLON SSL 150</p> <p>FWHM / FWTM 9.0 + 50.0° / 23.0 + 71.0°</p> <p>Efficiency 93 %</p> <p>Peak intensity 4.9 cd/lm</p> <p>LEDs/each optic 1</p> <p>Light colour White</p> <p>Required components:</p>		
<p>SEOUL SEMICONDUCTOR</p> <p>LED Z5M3</p> <p>FWHM / FWTM 13.0 + 47.0° / 38.0 + 73.0°</p> <p>Efficiency 94 %</p> <p>Peak intensity 3.2 cd/lm</p> <p>LEDs/each optic 1</p> <p>Light colour White</p> <p>Required components:</p>		
<p>SEOUL SEMICONDUCTOR</p> <p>LED Z8Y22P</p> <p>FWHM / FWTM 13.0 + 47.0° / 38.0 + 74.0°</p> <p>Efficiency 92 %</p> <p>Peak intensity 2.9 cd/lm</p> <p>LEDs/each optic 1</p> <p>Light colour White</p> <p>Required components:</p>		

OPTICAL RESULTS (SIMULATED):



LED XP-G2 HE
FWHM / FWTM 14.0 + 50.0° / 34.0 + 78.0°
Efficiency 88 %
Peak intensity 2.9 cd/lm
LEDs/each optic 1
Light colour White
Required components:

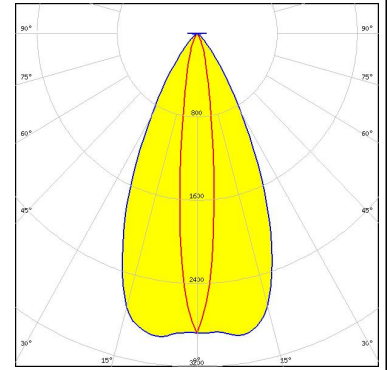

LED LUXEON SunPlus 20 Line (150 deg)
FWHM / FWTM 9.0 + 52.0° / 20.0 + 76.0°
Efficiency 88 %
Peak intensity 4.3 cd/lm
LEDs/each optic 1
Light colour White
Required components:

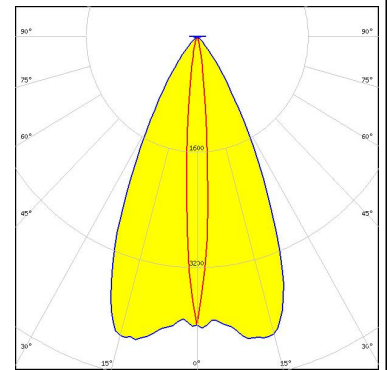

LED OSCONIQ P 3737 Flat
FWHM / FWTM 12.0 + 54.0° / 32.0 + 78.0°
Efficiency 91 %
Peak intensity 3.1 cd/lm
LEDs/each optic 1
Light colour White
Required components:

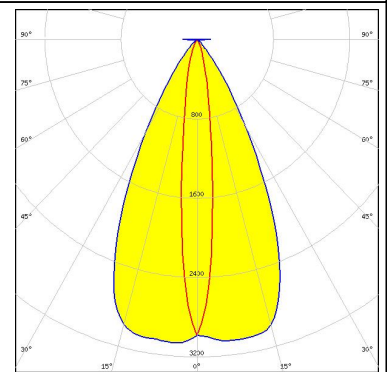

GENERAL INFORMATION:

NOTE: The typical beam angle will be changed by different color, chip size and chip position tolerance. The typical total beam angle is the full angle measured where the luminous intensity is half of the peak value.

MATERIALS:

As part of our continuous research and improvement processes, and to ensure the best possible quality and availability of our products, LEDiL reserves the right to change material grades without notice.

PRODUCT DATA USER AGREEMENT AND DISCLAIMER:

The measured data in the provided downloadable LEDiL Product Datasheets and Mechanical 2D-Drawings is rounded and provided as reference for planning. LEDiL Oy's optical specifications have been verified by conducting performance testing of the products in accordance with the company's quality system. The reported data are averaged results of multiple measurements with typical variation. LEDiL Oy reserves the right to without prior notification make changes and improvements to its products.

LEDiL Oy assumes neither warranty, nor guarantee nor any other liability of any kind for the contents and correctness of the provided data. The provided data has been generated with highest diligence but the provided data may in reality not represent the complete possible variation range of all intrinsic parameters. Therefore, in certain cases a deviation from the provided data could occur.

LEDiL Oy reserves the right to undertake technical changes of its products without further notification which could lead to changes in the provided data. LEDiL Oy assumes no liability of any kind for the possible deviation from any provided data or any other damage resulting from the usage of the provided data.

The user agrees to this disclaimer and user agreement with the download or usage of the provided files.

LEDiL Oy

Joensuunkatu 13
FI-24240 SALO
Finland

LEDiL Inc.

228 West Page Street
Suite D
Sycamore IL 60178
USA

Ledil Optics Technology (Shenzhen) Co., Ltd.

405 , Block B
Casic Motor Building
Shenzhen 518057
P.R.CHINA

Local sales and technical support

[www.ledil.com/
where_to_buy](http://www.ledil.com/where_to_buy)

Shipping locations

Salo, Finland
Hong Kong, China

Distribution Partners

[www.ledil.com/
where_to_buy](http://www.ledil.com/where_to_buy)