

## LISA2-W-CLIP

~35° wide beam optimized for CREE XP-E. 6.8 mm high variant with clip installation.

### SPECIFICATION:

Dimensions	Ø 9.9 mm
Height	6.8 mm
Fastening	glue, clips
ROHS compliant	yes ⓘ



### MATERIALS:

Component	Type	Material	Colour	Finish
LISA2-W	Single lens	PMMA	clear	
LISA2-HLD-CLIP16-XP	Holder	PC	black	

### ORDERING INFORMATION:

Component		Qty in box	MOQ	MPQ	Box weight (kg)
FP13031_LISA2-W-CLIP	Single lens	2000	300	100	1.4
» Box size: 310 x 230 x 60 mm					

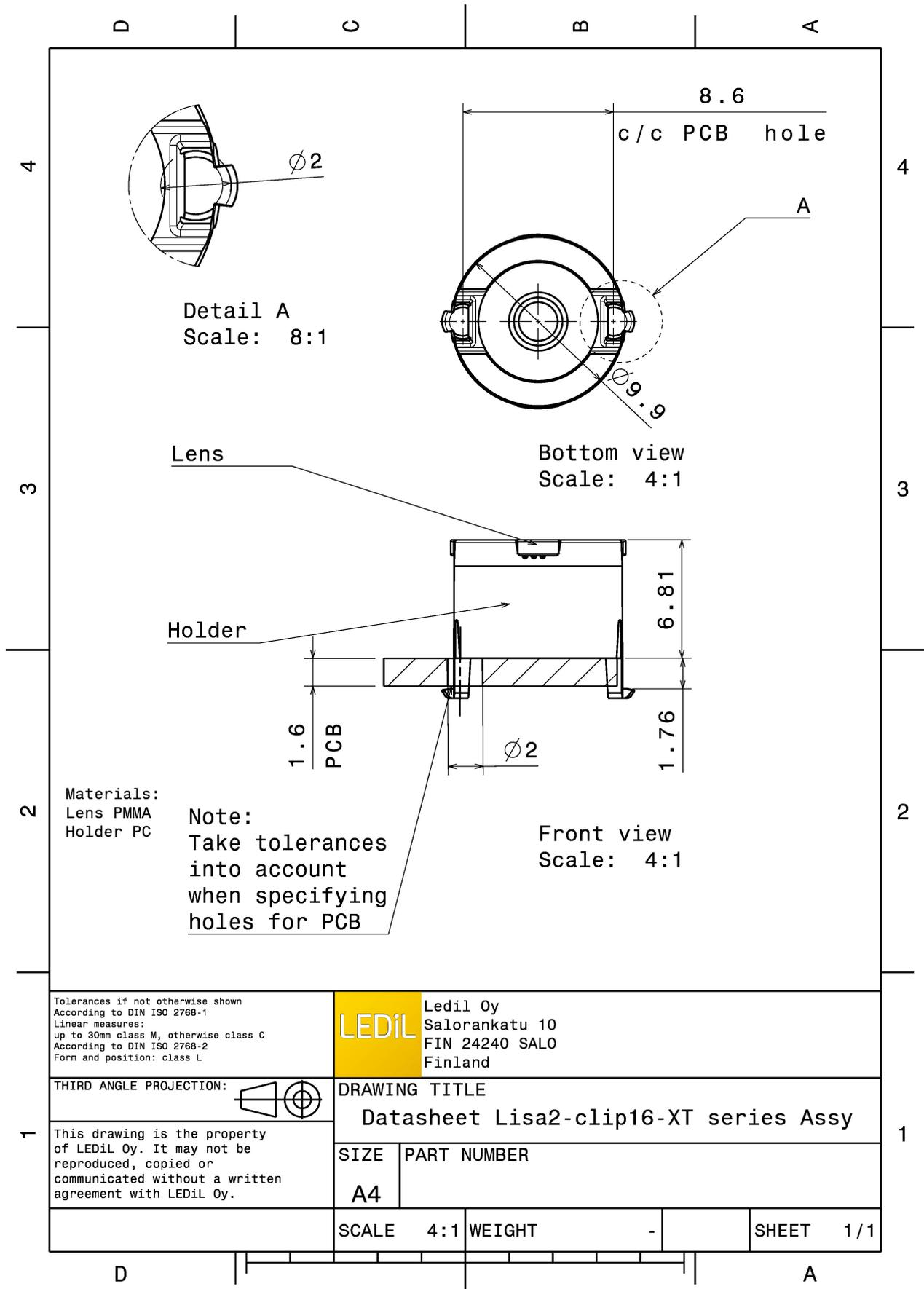

Tolerances if not otherwise shown  
According to DIN ISO 2768-1  
Linear measures:  
up to 30mm class M, otherwise class C  
According to DIN ISO 2768-2  
Form and position: class L

**LEDiL** LediL Oy  
Salorankatu 10  
FIN 24240 SALO  
Finland

THIRD ANGLE PROJECTION:

**DRAWING TITLE**  
Datasheet Lisa2-clip16-XT series Assy

This drawing is the property of LEDiL Oy. It may not be reproduced, copied or communicated without a written agreement with LEDiL Oy.

<b>SIZE</b>	<b>PART NUMBER</b>
A4	

<b>SCALE</b>	4:1	<b>WEIGHT</b>	-	<b>SHEET</b>	1/1
--------------	-----	---------------	---	--------------	-----

See also our general installation guide: [www.ledil.com/installation\\_guide](http://www.ledil.com/installation_guide)

#### OPTICAL RESULTS (MEASURED):

##### CREE LED

LED XP-G2  
 FWHM / FWTM 36.0° / 55.0°  
 Efficiency 88 %  
 Peak intensity 2.2 cd/lm  
 LEDs/each optic 1  
 Light colour White  
 Required components:

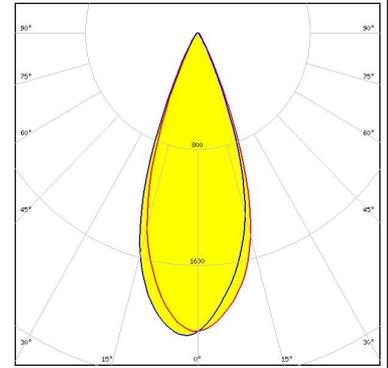

##### CREE LED

LED XP-G3  
 FWHM / FWTM 41.0° / 66.0°  
 Efficiency 85 %  
 Peak intensity 1.7 cd/lm  
 LEDs/each optic 1  
 Light colour White  
 Required components:

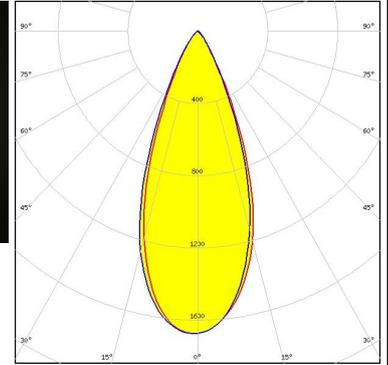
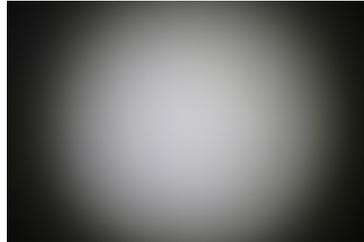

##### CREE LED

LED XT-E  
 FWHM / FWTM 32.0° / 51.0°  
 Efficiency 84 %  
 Peak intensity 2.2 cd/lm  
 LEDs/each optic 1  
 Light colour White  
 Required components:

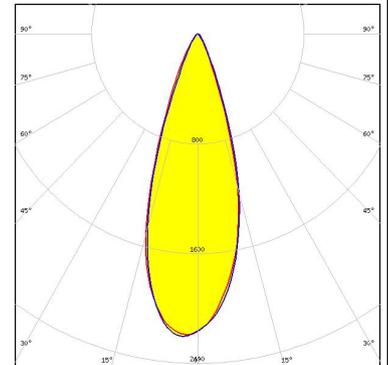

##### LUMILEDS

LED LUXEON T  
 FWHM / FWTM 36.0° / 58.0°  
 Efficiency 86 %  
 Peak intensity 2 cd/lm  
 LEDs/each optic 1  
 Light colour White  
 Required components:

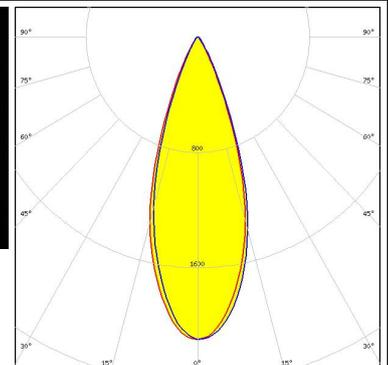

#### OPTICAL RESULTS (MEASURED):

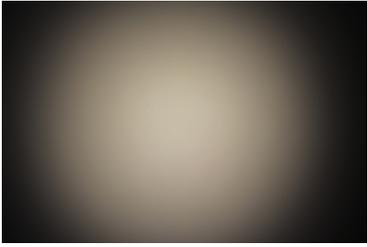
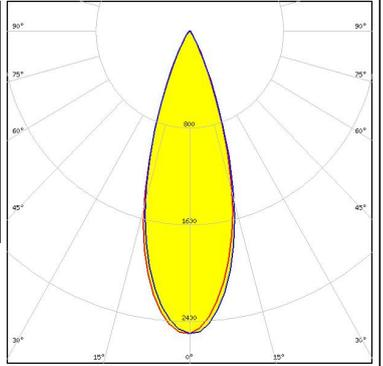
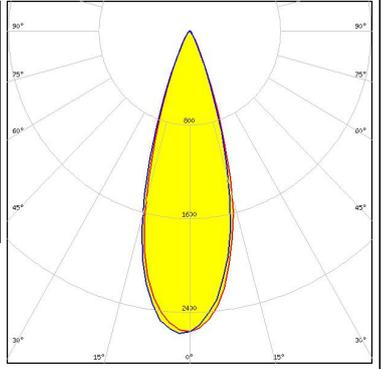
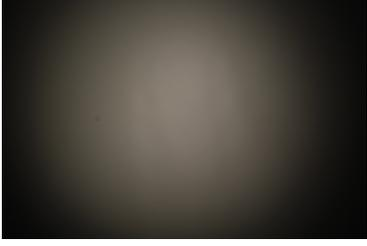
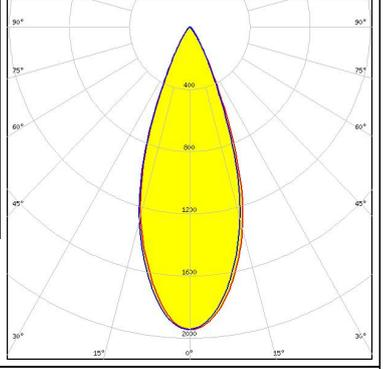
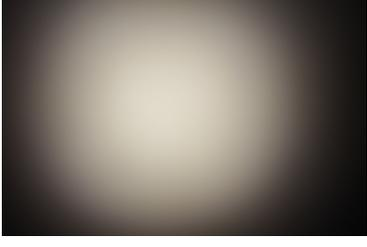
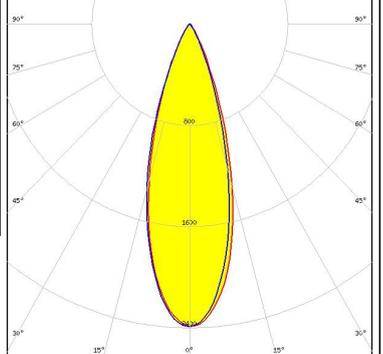
<p><b>LUMILEDS</b></p> <p>LED LUXEON TX            FWHM / FWTM 34.0° / 55.0°            Efficiency 88 %            Peak intensity 2.5 cd/lm            LEDs/each optic 1            Light colour White            Required components:</p>		
<p><b>NICHIA</b></p> <p>LED NCSxx19B            FWHM / FWTM 34.0° / 53.0°            Efficiency 84 %            Peak intensity 2.6 cd/lm            LEDs/each optic 1            Light colour White            Required components:</p>		
<p><b>NICHIA</b></p> <p>LED NVSxx19B/NVSxx19C            FWHM / FWTM 38.0° / 61.0°            Efficiency 87 %            Peak intensity 1.9 cd/lm            LEDs/each optic 1            Light colour White            Required components:</p>		
<p><b>OSRAM</b>  <small>Opto Semiconductors</small></p> <p>LED OSLON Square EC            FWHM / FWTM 33.0° / 57.0°            Efficiency 85 %            Peak intensity 2.4 cd/lm            LEDs/each optic 1            Light colour White            Required components:</p>		

#### OPTICAL RESULTS (MEASURED):

### SAMSUNG

LED LH351B  
FWHM / FWTM 40.0° / 64.0°  
Efficiency 88 %  
Peak intensity 1.9 cd/lm  
LEDs/each optic 1  
Light colour White  
Required components:

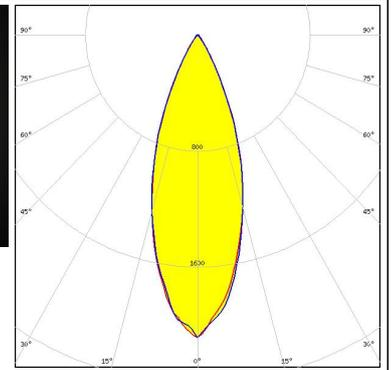

### SAMSUNG

LED LH351Z  
FWHM / FWTM 38.0° / 60.0°  
Efficiency 88 %  
Peak intensity 2.1 cd/lm  
LEDs/each optic 1  
Light colour White  
Required components:

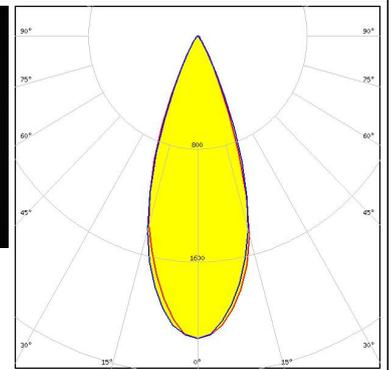
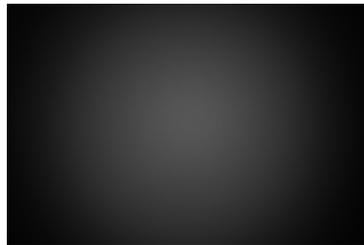

#### OPTICAL RESULTS (SIMULATED):

<p><b>CREE</b> LED</p> <p>LED: XP-G2 HE            FWHM / FWTM: 43.0° / 68.0°            Efficiency: 88 %            Peak intensity: 1.6 cd/lm            LEDs/each optic: 1            Light colour: White            Required components:</p>	
<p><b>LUMILEDS</b></p> <p>LED: LUXEON H50-2            FWHM / FWTM: 30.0° / 52.0°            Efficiency: 89 %            Peak intensity: 2.8 cd/lm            LEDs/each optic: 1            Light colour: White            Required components:</p>	
<p><b>LUMILEDS</b></p> <p>LED: LUXEON IR Compact            FWHM / FWTM: 34.0° / 47.0°            Efficiency: 83 %            LEDs/each optic: 1            Light colour: White            Required components:</p>	
<p><b>OSRAM</b>  <small>Opto Semiconductors</small></p> <p>LED: SFH 4715S            FWHM / FWTM: 22.0° / 36.0°            Efficiency: 90 %            Peak intensity: 5.1 cd/lm            LEDs/each optic: 1            Light colour: White            Required components:</p>	

### OPTICAL RESULTS (SIMULATED):

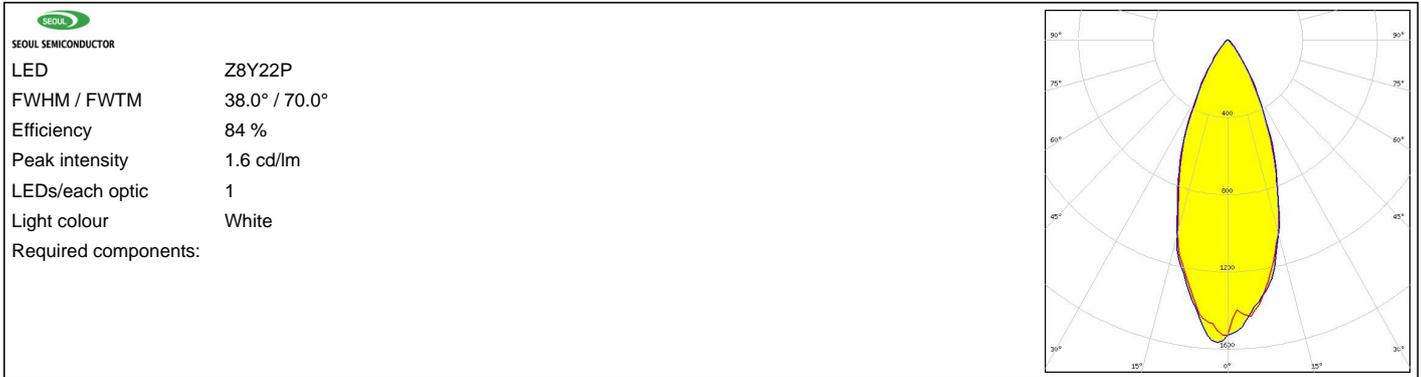

### GENERAL INFORMATION:

NOTE: The typical beam angle will be changed by different color, chip size and chip position tolerance. The typical total beam angle is the full angle measured where the luminous intensity is half of the peak value.

### MATERIALS:

As part of our continuous research and improvement processes, and to ensure the best possible quality and availability of our products, LEDiL reserves the right to change material grades without notice.

### PRODUCT DATA USER AGREEMENT AND DISCLAIMER:

The measured data in the provided downloadable LEDiL Product Datasheets and Mechanical 2D-Drawings is rounded and provided as reference for planning. LEDiL Oy's optical specifications have been verified by conducting performance testing of the products in accordance with the company's quality system. The reported data are averaged results of multiple measurements with typical variation. LEDiL Oy reserves the right to without prior notification make changes and improvements to its products.

LEDiL Oy assumes neither warranty, nor guarantee nor any other liability of any kind for the contents and correctness of the provided data. The provided data has been generated with highest diligence but the provided data may in reality not represent the complete possible variation range of all intrinsic parameters. Therefore, in certain cases a deviation from the provided data could occur.

LEDiL Oy reserves the right to undertake technical changes of its products without further notification which could lead to changes in the provided data. LEDiL Oy assumes no liability of any kind for the possible deviation from any provided data or any other damage resulting from the usage of the provided data.

The user agrees to this disclaimer and user agreement with the download or usage of the provided files.

#### LEDiL Oy

Joensuunkatu 13  
FI-24240 SALO  
Finland

#### LEDiL Inc.

228 West Page Street  
Suite D  
Sycamore IL 60178  
USA

#### Ledil Optics Technology (Shenzhen) Co., Ltd.

# 405 , Block B  
Casic Motor Building  
Shenzhen 518057  
P.R.CHINA

#### Local sales and technical support

[www.ledil.com/  
where\\_to\\_buy](http://www.ledil.com/where_to_buy)

#### Shipping locations

Salo, Finland  
Hong Kong, China

#### Distribution Partners

[www.ledil.com/  
where\\_to\\_buy](http://www.ledil.com/where_to_buy)