



TAOGLAS®



Datasheet

Magma X

Part No:
AA.178.301111

Description:

Magma X IP67 Magnetic Mount GPS L1/L5, External Antenna with 3m RG-174 SMA(M)

Features:

GPS L1 & L5/IRNSS Band Operation
Magnetic Mount
Low Noise Figure
Excellent Out-Of-Band Rejection
Low Axial Ratio
Cable: 3m RG-174
Connector: SMA(M)
RoHS & Reach Compliant

1. Introduction	3
2. Specifications	4
3. Antenna Characteristics	6
4. Active Antenna Characteristics	9
5. Radiation Patterns	12
6. Mechanical Drawing	14
7. Packaging	15
<hr/>	
Changelog	16

Taoglas makes no warranties based on the accuracy or completeness of the contents of this document and reserves the right to make changes to specifications and product descriptions at any time without notice. Taoglas reserves all rights to this document and the information contained herein.

Reproduction, use or disclosure to third parties without express permission is strictly prohibited.



1. Introduction



The Taoglas Magma X AA.178.301111 is an active, external magnetic mount, GPS antenna supporting both L1 and L5 bands. The L5 band also operates at the same frequency as IRNSS, so the Magma X can be used to operate on this constellation. It is a dual-band, high performance, economical solution for the highest accuracy centimeter-level tracking applications.

Typical applications include:

- RTK Applications
- Precision Agriculture
- Navigation

This compact antenna exhibits excellent radiation patterns on both L1 and L5 bands and with a low noise figure to preserve signal quality helps minimize time to first fix. It also features excellent out-of-band rejection to prevent out-of-band signals from overdriving or damaging its LNAs.

This antenna has been tuned and tested on a 70 x 70 mm ground plane, working at GPS L1, 1575.42 MHz and IRNSS / L5, 1176MHz, with a 2 stage LNA ensuring good signal strength. It can operate with an input voltage ranging from 1.8 to 5 volts.

Cable length and connectors are fully customizable. Contact your regional Taoglas customer support team to request these services or additional support to integrate and test this antenna's performance in your device.

2. Specifications

GNSS Frequency Bands Covered

GPS/QZSS	L1 1575.42MHz	L2 1227.6MHz	L5 1176.45MHz	L6 1278.75MHz			
	■	□	■	□			
GLONASS	L5R 1176.45MHz	L3PT 1201.5MHz	L2PT 1246MHz	L1CR 1575.42MHz	L1PT 1602MHz		
	■	□	□	■	□		
Galileo	E5a 1176.45MHz	E5b 1201.5MHz	E4 1215MHz	E3 1256MHz	E6 1278.75MHz	E2 1561MHz	L1 1575.42MHz
	■	□	□	□	□	□	■
BeiDou	B1 1561MHz	B2 1207.14MHz	B3 1268.52MHz				
	□	□	□				
Compass	E5B(B2)/ E6(B3) 1268.56MHz	E2(B1) 1561MHz					
	□	□					
SBAS	Omnistar 1542.5MHz	WAAS/EGN OS 1575.42MHz					
	□	■					
IRNSS	L5 1176.45MHz	S-Band 2483.778MHz					
	■	□					

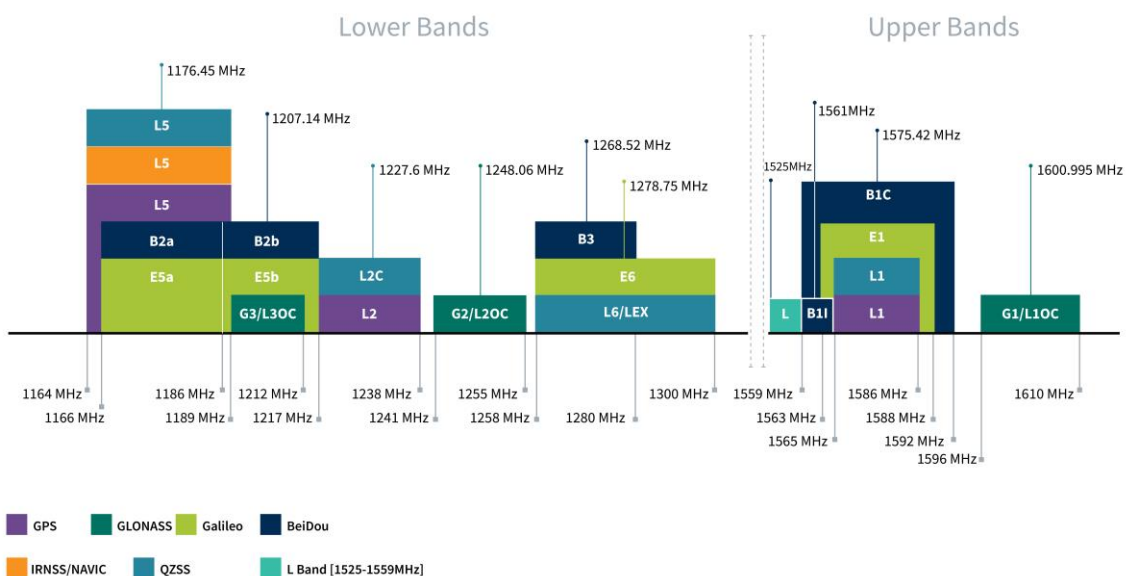

GNSS Bands and Constellations

GNSS Electrical		
Frequency (MHz)	1176.45	1575.42
VSWR	<2	<2
Efficiency (%)	62.25	55.28
Peak Gain (dBi)	1.1	1.36
Average Gain (dB)	-2.06	-2.57
Axial Ratio at Zenith	1.74	1.70
Polarization	RHCP	
Impedance	50 Ω	
LNA and Filter Electrical Properties		
Frequency (MHz)	1176.45	1575.42
Compression Point 1dB Gain	0	2
Return Loss (dB)	10	10
Gain@1.8V (Typ.) (dB)	11	11
Gain@3.0V (Typ.) (dB)	19	18
Gain@5.5V (Typ.) (dB)	25	22
Noise@3.0V (Typ.) (dB)	1.5	1.4
Power consumption@3.0V (Typ.)	12mA	
Output Impedance	50 Ω	
Mechanical		
Housing Dimensions	49.8*52.4*17.1mm	
Housing Material	ABS	
Cable	3m RG-174 (fully customizable)	
Connector	SMA(M) (fully customizable)	
Waterproof	IP67	
Weight	98g	
Magnetic Pull Force	Pull horizontal max pull force(kgf): 0.52 Pull vertical max pull force(kgf): 0.48	
Environmental		
Operation Temperature	-40°C ~ +85°C	
Storage Temperature	-40°C ~ +90°C	
Humidity	Non-condensing 65°C 95% RH	

3. Antenna Characteristics

3.1 VSWR

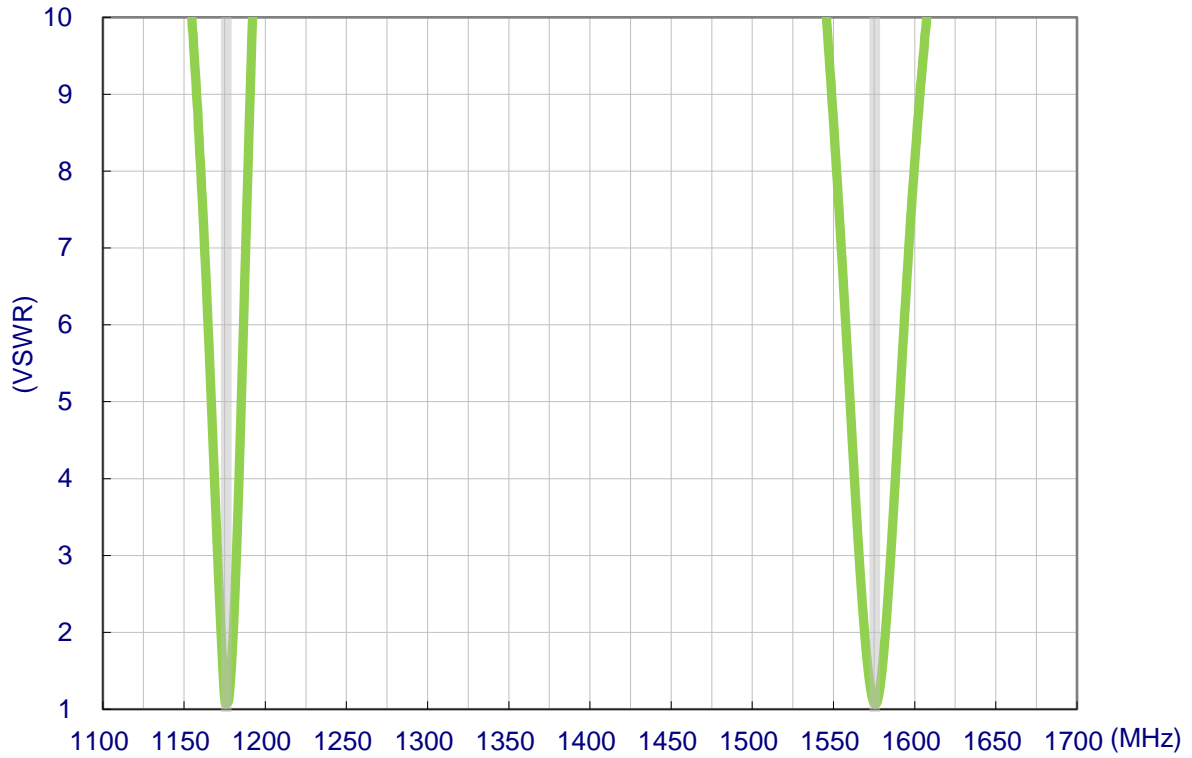

3.2 Efficiency

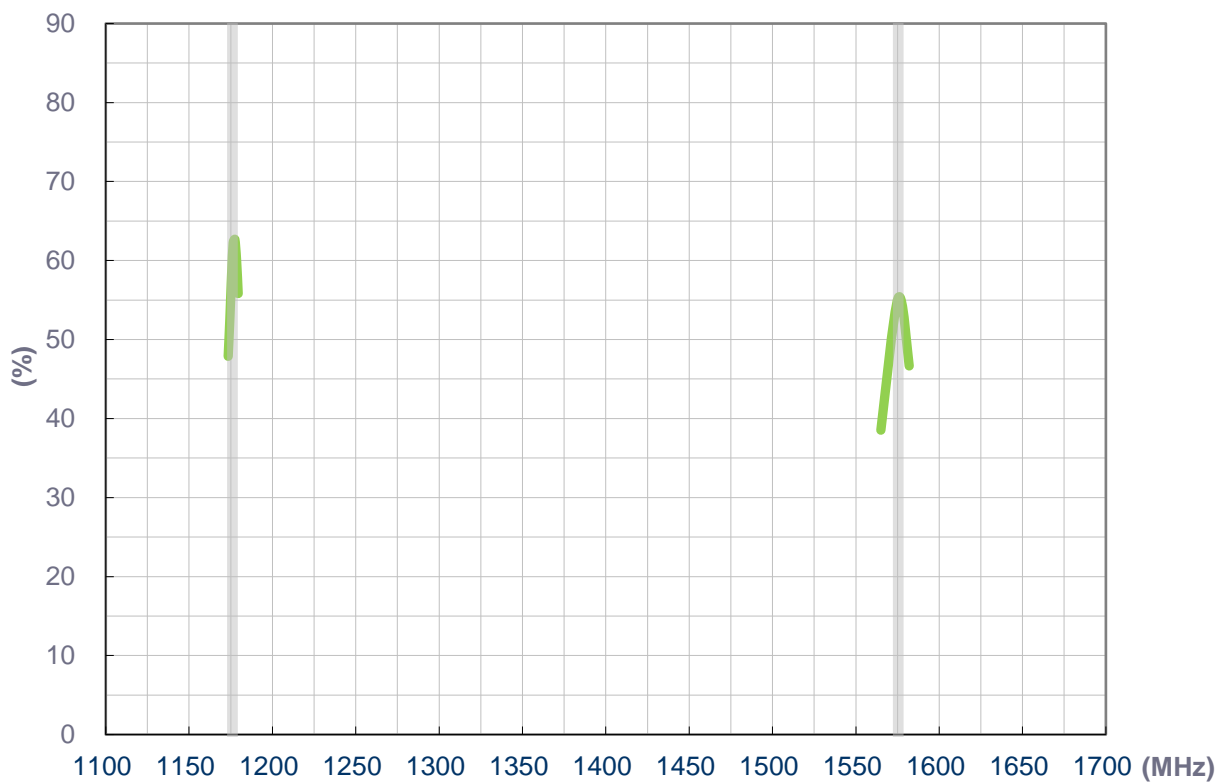

3.3 Average Gain

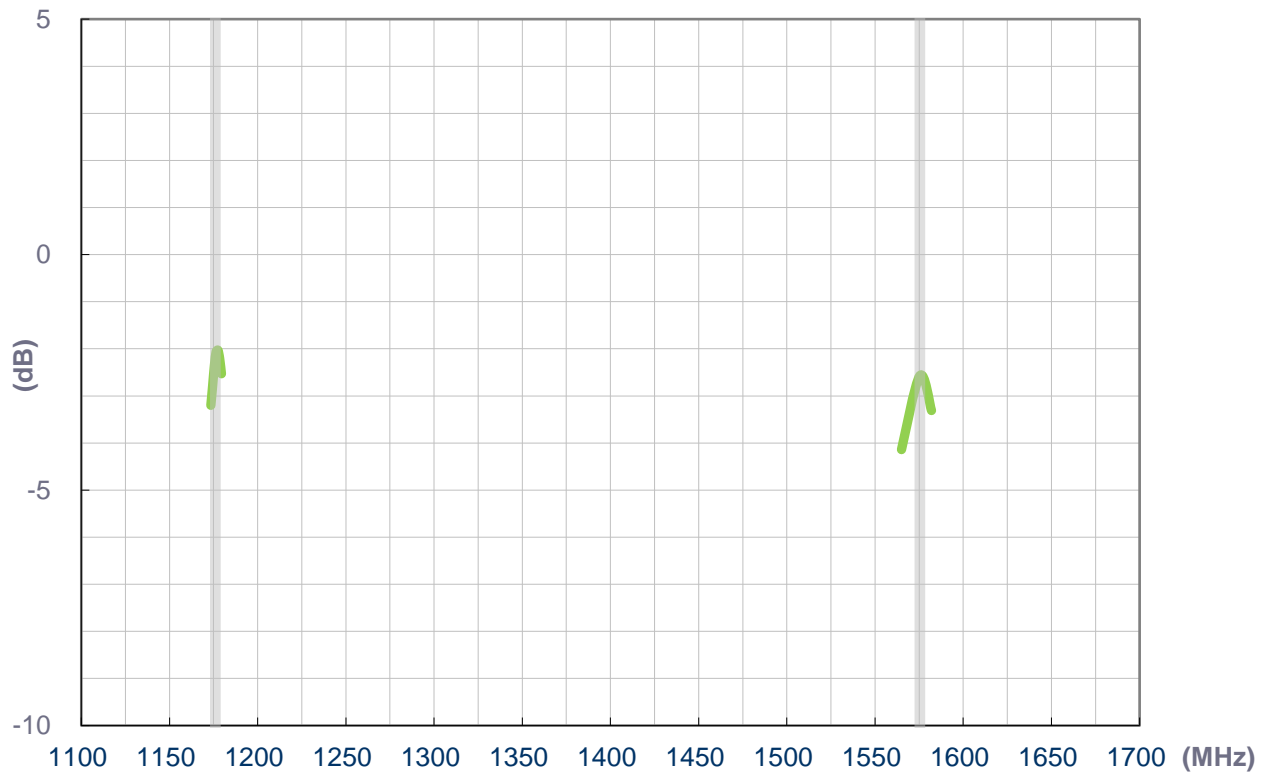

3.4 Peak Gain

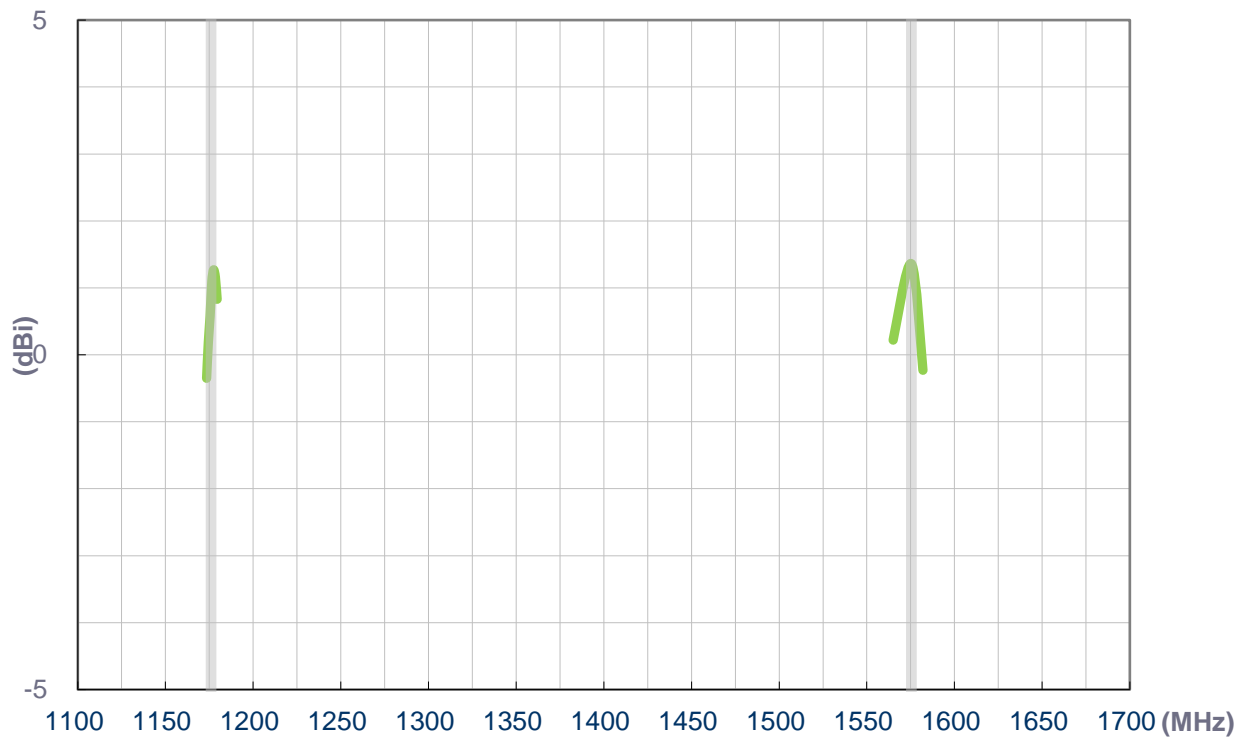

3.5 Axial Ratio XZ

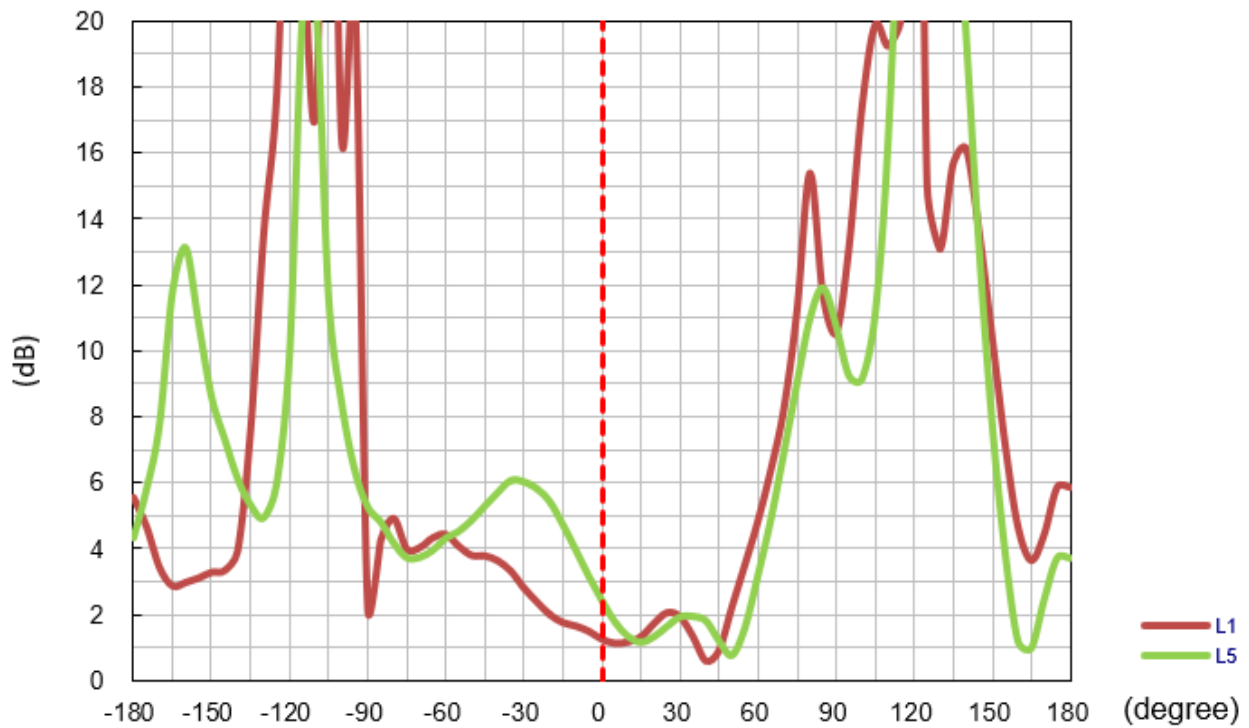

3.6 Axial Ratio YZ

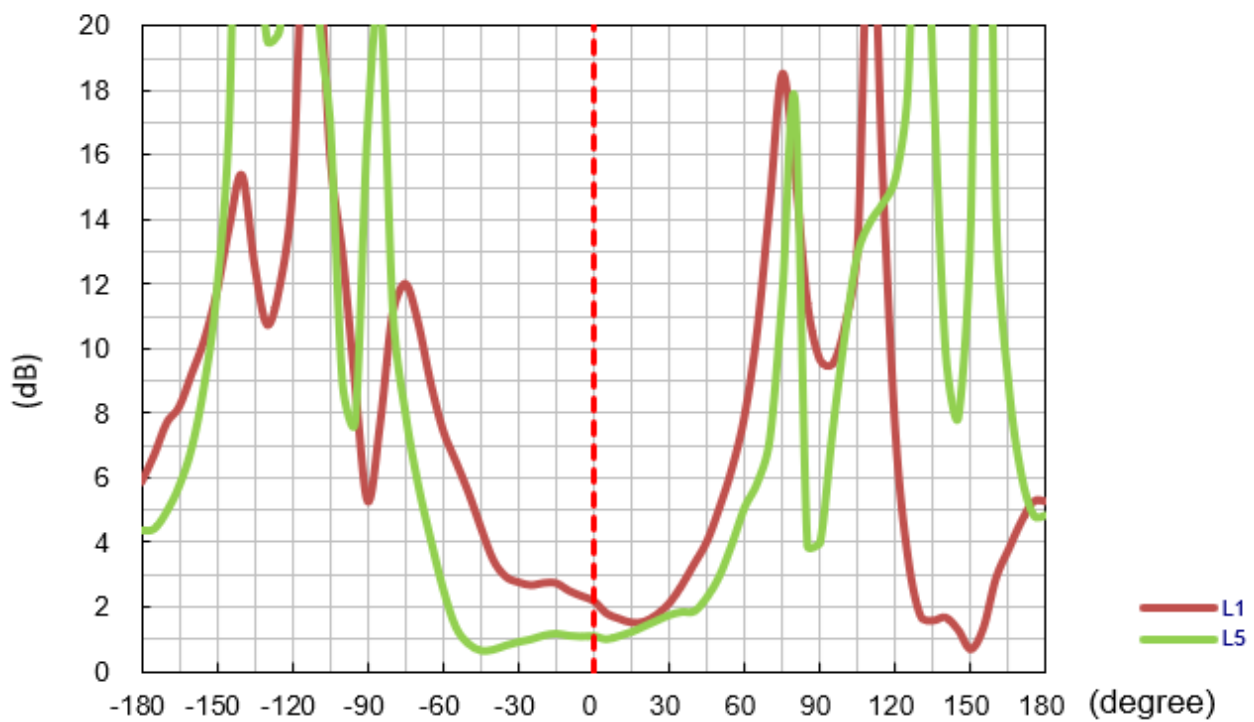

4. Active Antenna Characteristics

4.1 LNA Block Diagram

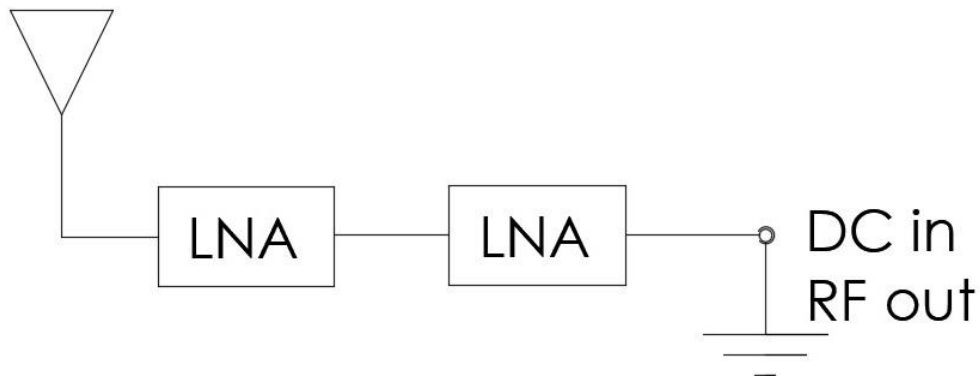

4.2 LNA Gain Narrow Band

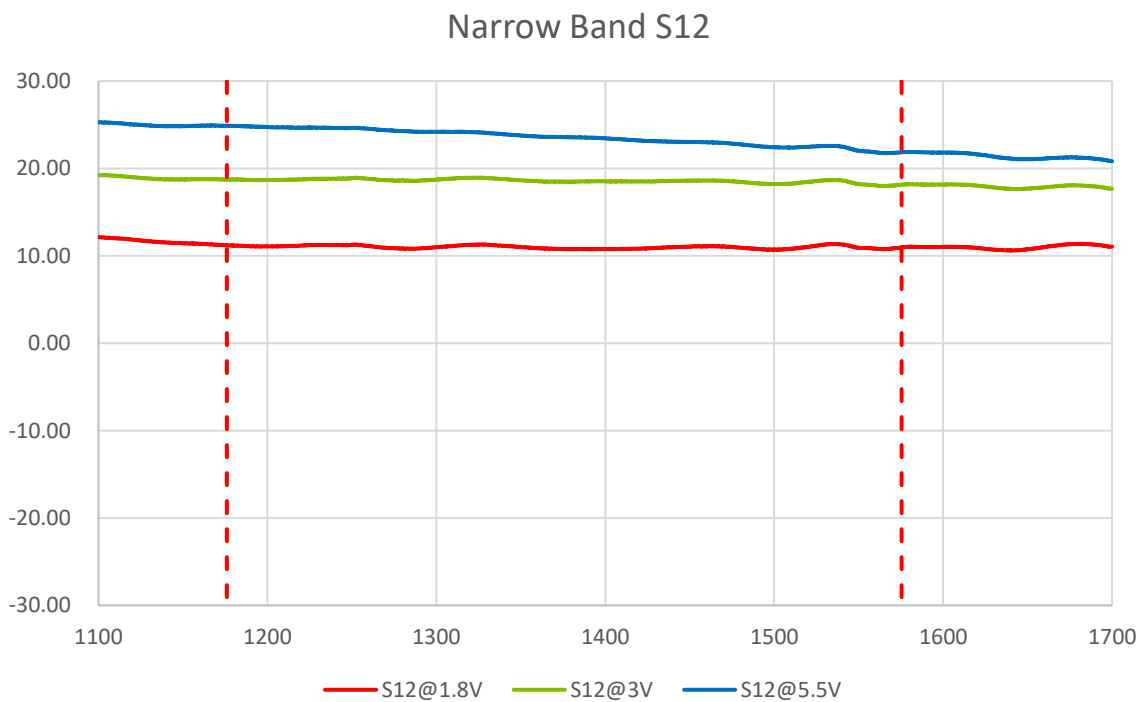

4.3 LNA Gain Wide Band

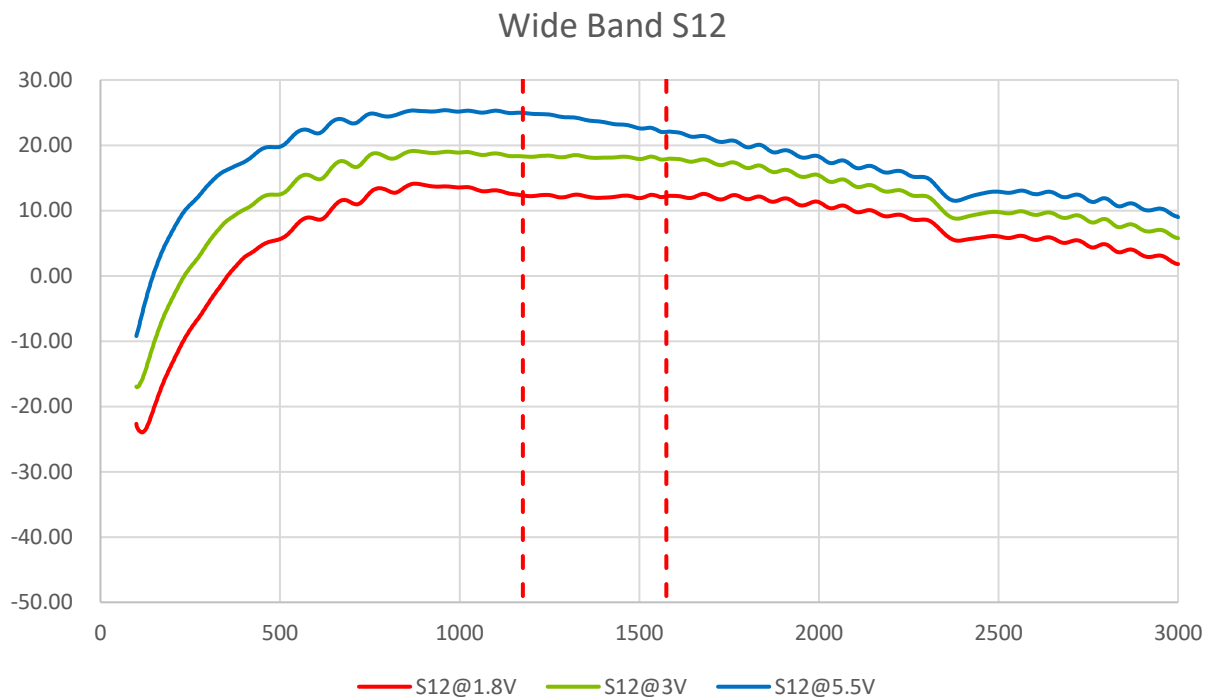

4.4 S11 Narrow Band

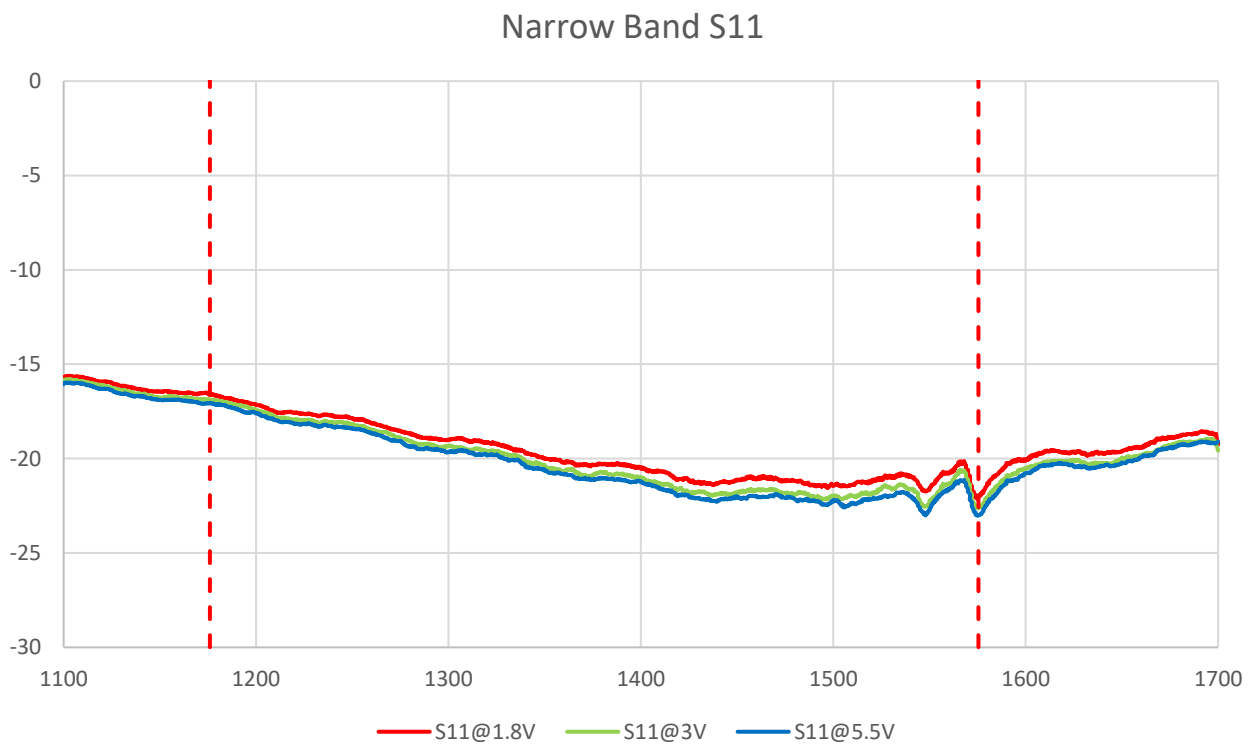

4.5 S11 Wide Band

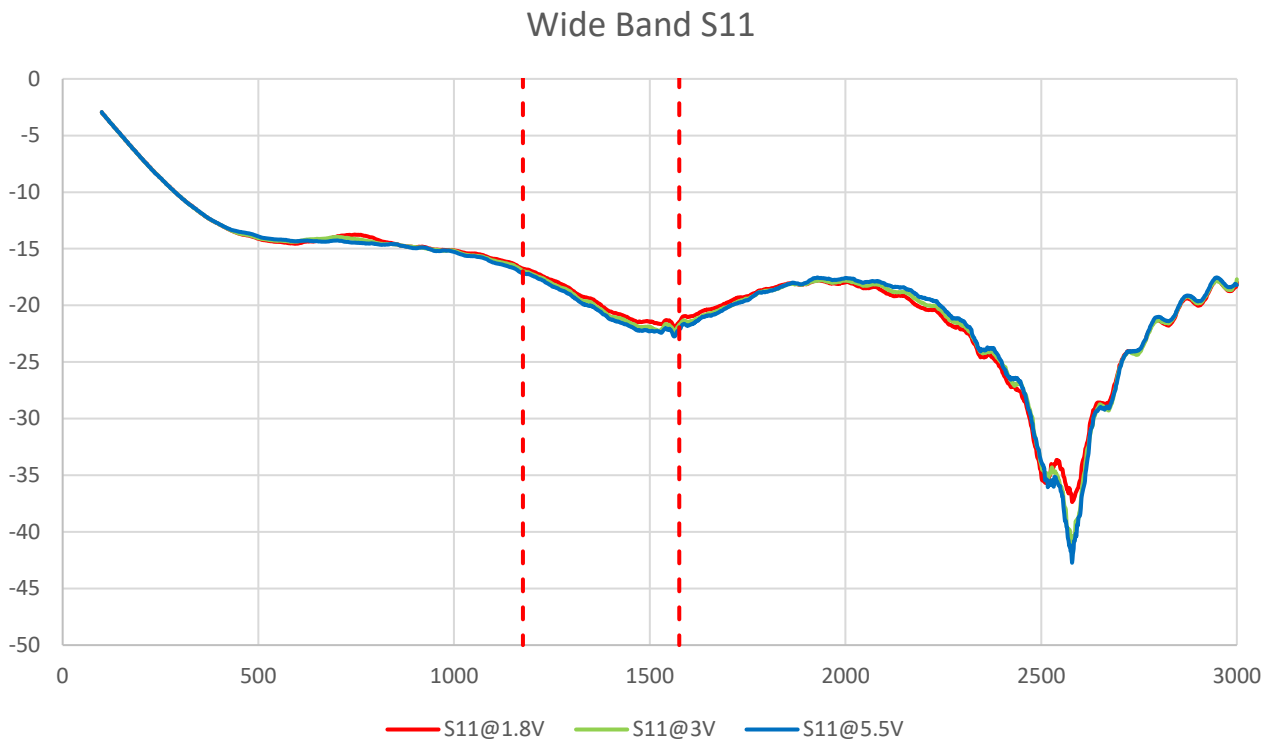

4.6 LNA Noise Wide Band

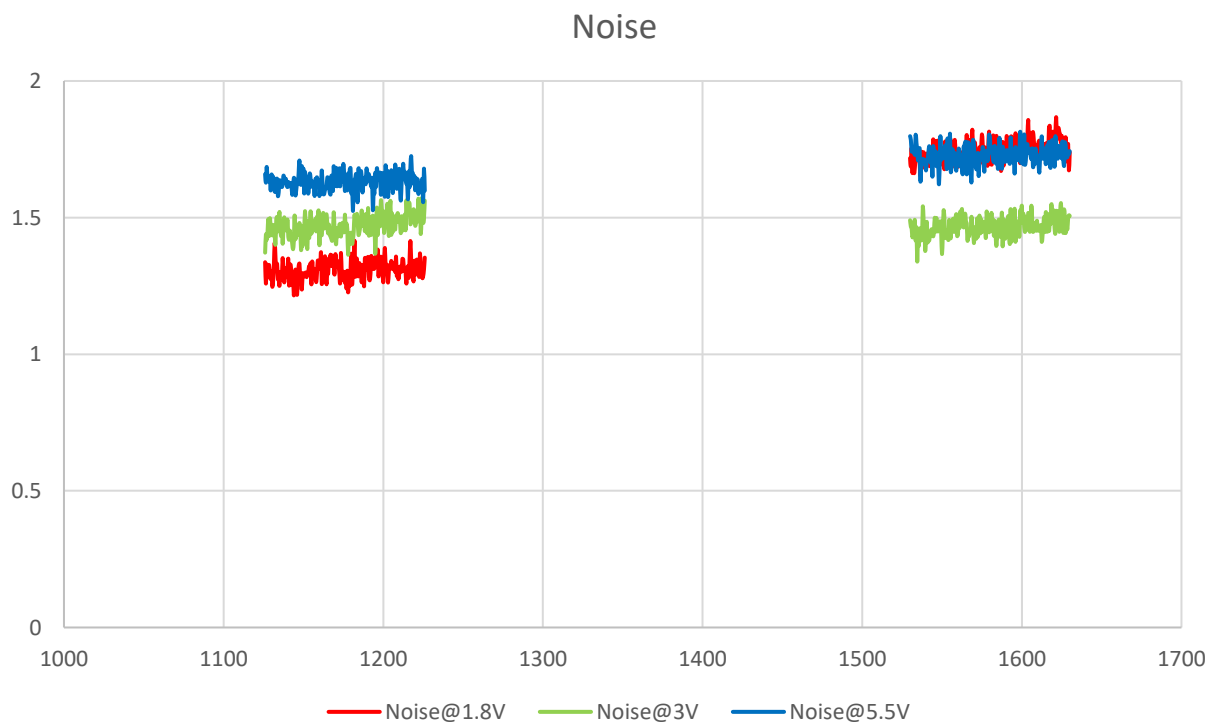

5. Radiation Patterns

5.1 Test Setup

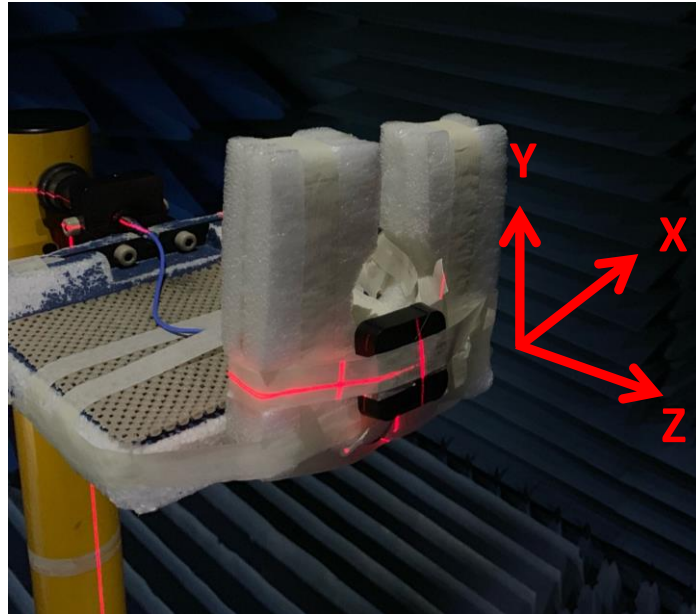

5.2 3D and 2D Radiation Patterns

1176.45MHz

1575.42MHz

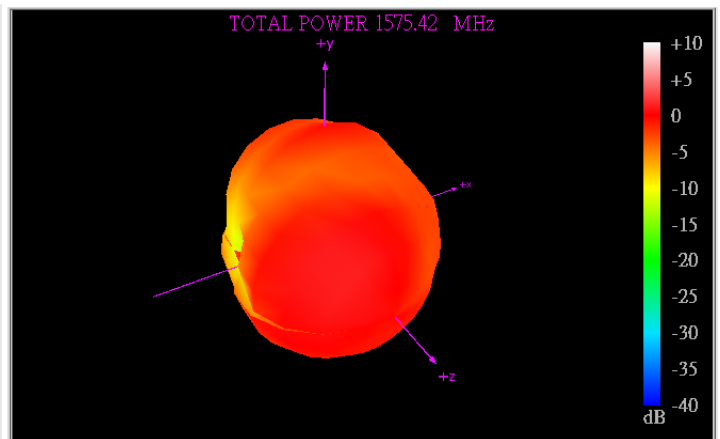
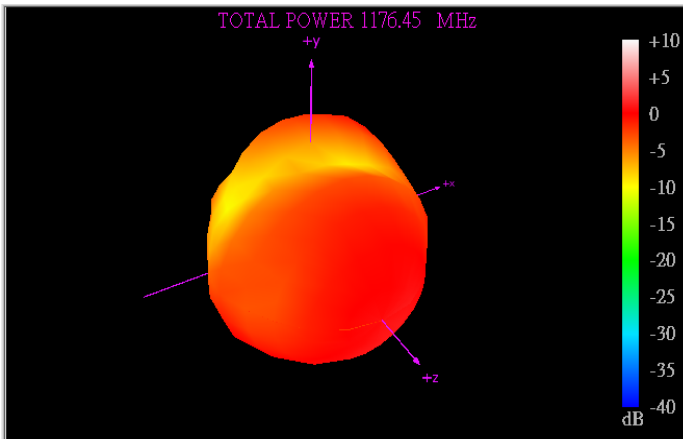

XY Plane

XZ Plane

YZ Plane

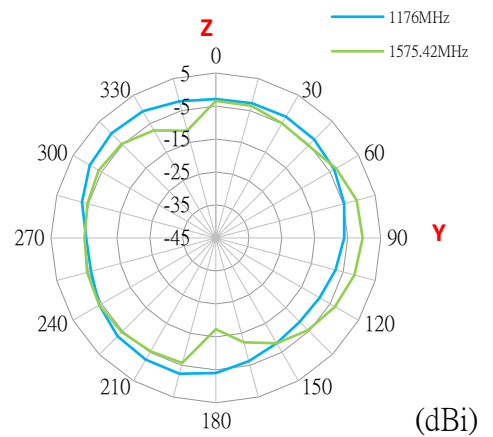
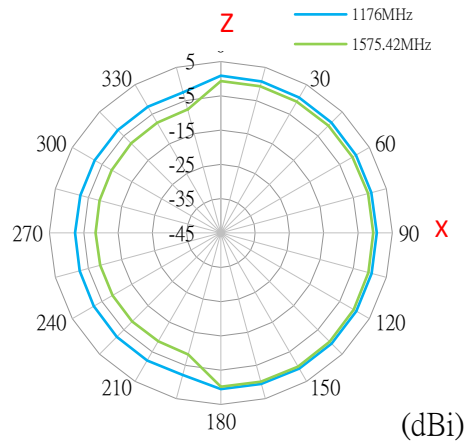
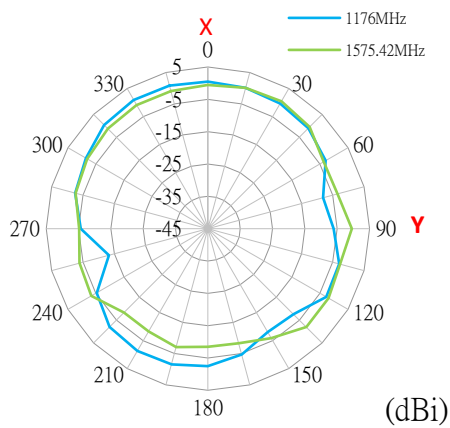

6. Mechanical Drawing (Units: mm)

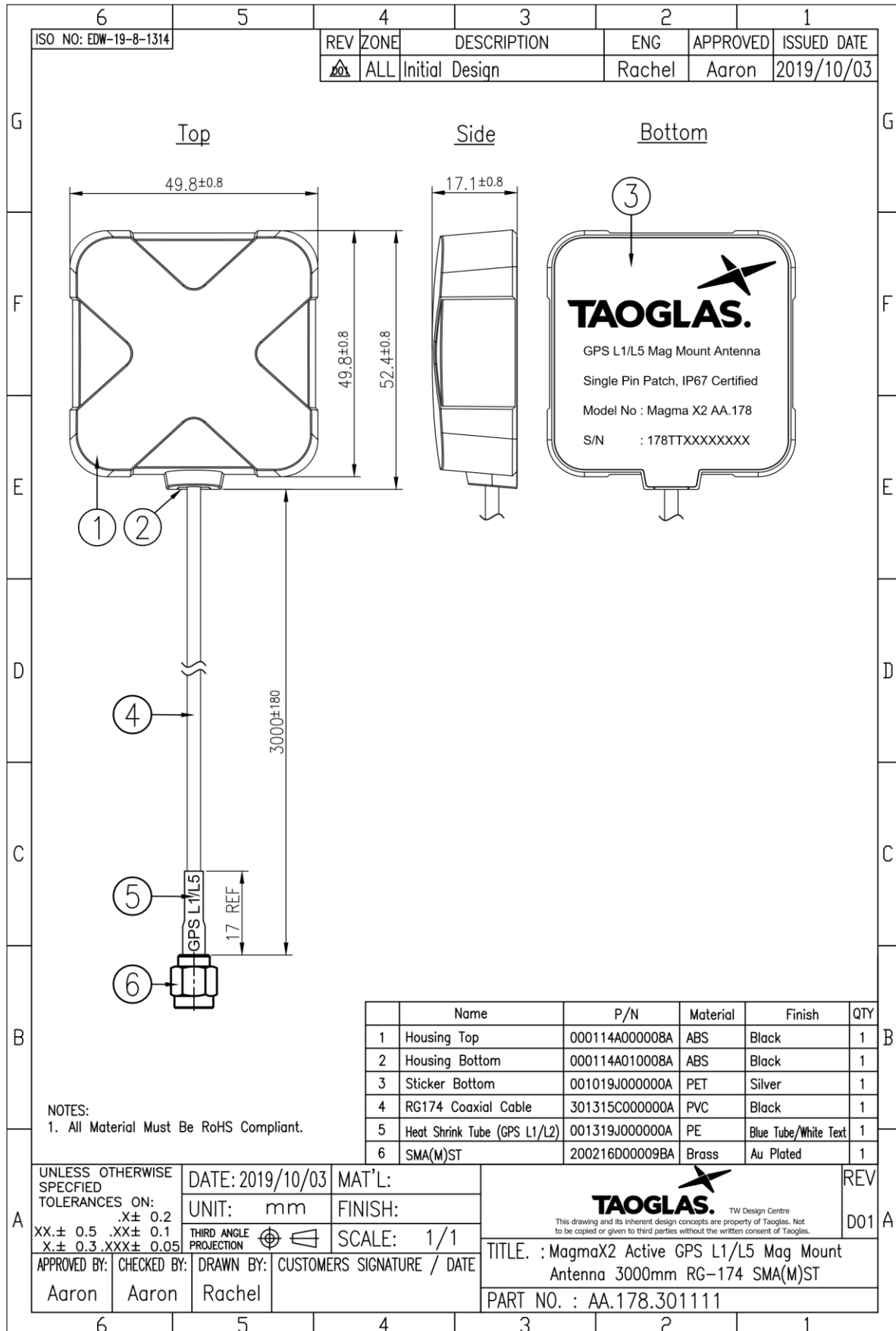

7. Packaging

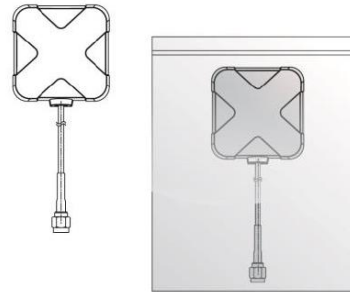

1 pcs AA.178.301111 per PE Bag
 SPQ: 10pcs AA.178.301111 PE Bag
 Weight: 1.1Kg



100pcs AA.178.301111 per Carton
 Carton Dimensions-370*370*300mm
 Weight: 10.3Kg

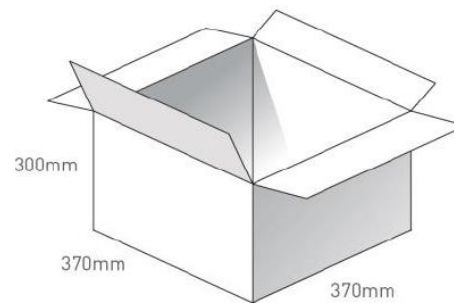

Changelog for the datasheet

SPE-20-8-089 – AA.178.301111

Revision: B (Current Version)

Date:	2022-02-22
Changes:	Updated GNSS Bands & Constellations Graphics
Changes Made by:	Cesar Sousa

Previous Revisions

Revision: A (Original First Release)

Date:	2020-08-14
Notes:	Initial Release
Author:	Jack Conroy



TAOGLAS®

www.taoglas.com

