

# XLamp® XHP35.2 LEDs

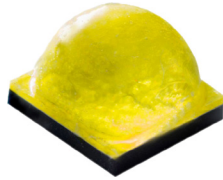

XHP35.2 High-Density LED

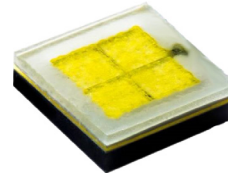

XHP35.2 High-Intensity LED

## PRODUCT DESCRIPTION

The XLamp® XHP35.2 LED is the next generation of Extreme High Power LEDs available in the XP footprint. Built on Cree LED's latest high-power LED array technology, the XHP35.2 LED improves the voltage characteristics, efficacy and reliability of the XHP35 LED in the same 3.45 mm x 3.45 mm footprint. The new XHP35.2 LED provides an easy drop-in upgrade so that lighting manufacturers can achieve higher system LPW on existing XHP35 designs with minimal system redesign cost.

The XHP35.2 LED offers a high-intensity option. In this document, the term XHP35.2 denotes the XHP35.2 LED without regard to high density or high intensity. The terms High Density and High Intensity are used when necessary to differentiate the performance of the two options.

## FEATURES

- Available in 5-step EasyWhite® bins at 2700 K–5700 K CCT and 3-step & 2-step EasyWhite bins at 2700 K–4000 K CCT
- Available in ANSI white bins at 2700 K to 7000 K CCT
- Available in standard, 70-, 80- and 90-minimum CRI options
- Binned at 85 °C
- Maximum drive current: 1500 mA
- Low thermal resistance: 0.7 °C/W
- Wide viewing angle - High Density:135°, High Intensity: 120°
- Unlimited floor life at ≤ 30 °C/85% RH
- Reflow solderable - JEDEC J-STD-020C
- RoHS and REACH compliant
- UL® recognized component (E349212)

## TABLE OF CONTENTS

Characteristics .....	2
Order Codes Suggested for New Designs - High Density EasyWhite® .....	3
Order Codes Suggested for New Designs - High Density ANSI.....	6
Order Codes Suggested for New Designs - High Intensity EasyWhite® .....	9
Order Codes Suggested for New Designs - High Intensity ANSI.....	13
Relative Spectral Power Distribution .....	16
Relative Flux vs. Junction Temperature.....	16
Electrical Characteristics.....	17
Relative Flux vs. Current .....	17
Relative Chromaticity vs. Current.....	18
Relative Chromaticity vs. Temperature.....	18
Typical Spatial Distribution.....	19
Thermal Design .....	19
Performance Groups – Luminous Flux.....	20
Performance Groups – Chromaticity.....	21
Standard Cool White Kits Plotted on ANSI Standard Chromaticity Regions .....	26
Standard Warm and Neutral White Kits Plotted on ANSI Standard Chromaticity Regions .....	27
Bin and Order Code Formats.....	28
Reflow Soldering Characteristics.....	29
Notes .....	30
Mechanical Dimensions .....	32
Tape and Reel.....	34
Packaging.....	37
Appendix - Order Codes Not For New Designs.....	38



## CHARACTERISTICS

Characteristics	Unit	Minimum	Typical	Maximum
Thermal resistance, junction to solder point	°C/W		0.7	
Viewing angle (FWHM) - High Density	degrees		135	
Viewing angle (FWHM) - High Intensity	degrees		120	
Temperature coefficient of voltage	mV/°C		-5	
ESD withstand voltage (HBM per Mil-Std-883D)				8000
DC forward current	mA			1500
Reverse voltage	V			1
Forward voltage (@ 350 mA, 85 °C)	V		11.2	12.2
LED junction temperature	°C			150

### Note

- Thermal resistance measurement was performed per the JEDEC JESD51-14 standard. See the [Thermal Resistance Measurement application note](#) for more details.

**ORDER CODES SUGGESTED FOR NEW DESIGNS - HIGH DENSITY EASYWHITE® (T<sub>j</sub> = 85 °C)**

The following table provides order codes for XLamp XHP35.2 High-Density LEDs. For a complete description of how the flux and chromaticity groups are reflected in the bin code and order code nomenclature, please see the Bin and Order Code Formats section (page 28).

Nominal CCT	CRI		Minimum Luminous Flux @350 mA		2-Step		3-Step		5-Step	
	Min	Typ	Group	Flux (lm) @ 85 °C	Group	Order Code	Group	Order Code	Group	Order Code
5700 K	70		E4	635					57E	XHP35B-00-0000-0D0BE457E
			E2	590						XHP35B-00-0000-0D0BE257E
	80		E2	590					57E	XHP35B-00-0000-0D0HE257E
			D4	550						XHP35B-00-0000-0D0HD457E
	90		D2	510					57E	XHP35B-00-0000-0D0UD257E
			C4	475						XHP35B-00-0000-0D0UC457E
C2			440	XHP35B-00-0000-0D0UC257E						
5000 K	70		E4	635					50E	XHP35B-00-0000-0D0BE450E
			E2	590						XHP35B-00-0000-0D0BE250E
	80		E2	590					50E	XHP35B-00-0000-0D0HE250E
			D4	550						XHP35B-00-0000-0D0HD450E
	90		D2	510					50E	XHP35B-00-0000-0D0UD250E
			C4	475						XHP35B-00-0000-0D0UC450E
C2			440	XHP35B-00-0000-0D0UC250E						

**Notes:**

- Cree LED maintains a tolerance of ±7% on flux and power measurements, ±0.005 on chromaticity (CCx, CCy) measurements and ±2 on CRI measurements. See the Measurements section (page 30).
- XLamp XHP35.2 LED order codes specify only a minimum flux bin and not a maximum. Cree LED may ship reels in flux bins higher than the minimum specified by the order code without advance notice. Shipments will always adhere to the chromaticity bin restrictions specified by the order code.

ORDER CODES SUGGESTED FOR NEW DESIGNS - HIGH DENSITY EASYWHITE® (T<sub>j</sub> = 85 °C) - CONTINUED

Nominal CCT	CRI		Minimum Luminous Flux @350 mA		2-Step		3-Step		5-Step		
	Min	Typ	Group	Flux (lm) @ 85 °C	Group	Order Code	Group	Order Code	Group	Order Code	
4500 K	70		E4	635					45E	XHP35B-00-0000-0D0BE445E	
			E2	590						XHP35B-00-0000-0D0BE245E	
	80		E2	590					45E	XHP35B-00-0000-0D0HE245E	
			D4	550						XHP35B-00-0000-0D0HD445E	
	90			D2	510					45E	XHP35B-00-0000-0D0UD245E
				C4	475						XHP35B-00-0000-0D0UC445E
			C2	440					XHP35B-00-0000-0D0UC245E		
4000 K	70		E4	635					40E	XHP35B-00-0000-0D0BE440E	
			E2	590						XHP35B-00-0000-0D0BE240E	
	80		E2	590			40G	XHP35B-00-0000-0D0HE240G	40E	XHP35B-00-0000-0D0HE240E	
			D4	550				XHP35B-00-0000-0D0HD440G		XHP35B-00-0000-0D0HD440E	
	90			C4	475			XHP35B-00-0000-0D0UC440H		40E	XHP35B-00-0000-0D0UC440E
				C2	440	40H		XHP35B-00-0000-0D0UC240H	40G		XHP35B-00-0000-0D0UC240G
			B4	410			XHP35B-00-0000-0D0UB440H		XHP35B-00-0000-0D0UB440G		XHP35B-00-0000-0D0UB440E
3500 K	70		E2	590					35E	XHP35B-00-0000-0D0BE235E	
			D4	550						XHP35B-00-0000-0D0BD435E	
	80		D4	550			35G	XHP35B-00-0000-0D0HD435G	35E	XHP35B-00-0000-0D0HD435E	
			D2	510				XHP35B-00-0000-0D0HD235G		XHP35B-00-0000-0D0HD235E	
	90			C4	475			XHP35B-00-0000-0D0UC435H		35E	XHP35B-00-0000-0D0UC435E
				C2	440	35H		XHP35B-00-0000-0D0UC235H	35G		XHP35B-00-0000-0D0UC235G
			B4	410			XHP35B-00-0000-0D0UB435H		XHP35B-00-0000-0D0UB435G		XHP35B-00-0000-0D0UB435E

Notes:

- Cree LED maintains a tolerance of ±7% on flux and power measurements, ±0.005 on chromaticity (CCx, CCy) measurements and ±2 on CRI measurements. See the Measurements section (page 30).
- XLamp XHP35.2 LED order codes specify only a minimum flux bin and not a maximum. Cree LED may ship reels in flux bins higher than the minimum specified by the order code without advance notice. Shipments will always adhere to the chromaticity bin restrictions specified by the order code.

ORDER CODES SUGGESTED FOR NEW DESIGNS - HIGH DENSITY EASYWHITE® (T<sub>j</sub> = 85 °C) - CONTINUED

Nominal CCT	CRI		Minimum Luminous Flux @350 mA		2-Step		3-Step		5-Step	
	Min	Typ	Group	Flux (lm) @ 85 °C	Group	Order Code	Group	Order Code	Group	Order Code
3000 K	70		E2	590					30E	XHP35B-00-0000-0D0BE230E
			D4	550						XHP35B-00-0000-0D0BD430E
			D2	510						XHP35B-00-0000-0D0BD230E
	80		D4	550			30G	XHP35B-00-0000-0D0HD430G	30E	XHP35B-00-0000-0D0HD430E
			D2	510				XHP35B-00-0000-0D0HD230G		XHP35B-00-0000-0D0HD230E
	90		C2	440	30H	XHP35B-00-0000-0D0UC230H	30G	XHP35B-00-0000-0D0UC230G	30E	XHP35B-00-0000-0D0UC230E
			B4	410		XHP35B-00-0000-0D0UB430H		XHP35B-00-0000-0D0UB430G		XHP35B-00-0000-0D0UB430E
			B2	380		XHP35B-00-0000-0D0UB230H		XHP35B-00-0000-0D0UB230G		XHP35B-00-0000-0D0UB230E
	2700 K	80		D2	510		27G	XHP35B-00-0000-0D0HD227G	27E	XHP35B-00-0000-0D0HD227E
			C4	475		XHP35B-00-0000-0D0HC427G		XHP35B-00-0000-0D0HC427E		
90			B4	410	27H	XHP35B-00-0000-0D0UB427H	27G	XHP35B-00-0000-0D0UB427G	27E	XHP35B-00-0000-0D0UB427E
			B2	380		XHP35B-00-0000-0D0UB227H		XHP35B-00-0000-0D0UB227G		XHP35B-00-0000-0D0UB227E

Notes:

- Cree LED maintains a tolerance of ±7% on flux and power measurements, ±0.005 on chromaticity (CCx, CCy) measurements and ±2 on CRI measurements. See the Measurements section (page 30).
- XLamp XHP35.2 LED order codes specify only a minimum flux bin and not a maximum. Cree LED may ship reels in flux bins higher than the minimum specified by the order code without advance notice. Shipments will always adhere to the chromaticity bin restrictions specified by the order code.

**ORDER CODES SUGGESTED FOR NEW DESIGNS - HIGH DENSITY ANSI (T<sub>J</sub> = 85 °C)**

The following table provides order codes for XLamp XHP35.2 High-Density LEDs. For a complete description of how the flux and chromaticity groups are reflected in the bin code and order code nomenclature, please see the Bin and Order Code Formats section (page 28).

Nominal CCT	Chromaticity Regions	CRI		Minimum Luminous Flux @ 350 mA		Order Code		
		Min	Typ	Group	Flux (lm) @ 85 °C			
7000 K	0A, 0B, 0C, 0D, 0R, 0S, 0T, 0U, 1A, 1B, 1C, 1D, 1R, 1S, 1T, 1U	0	68	E2	590	XHP35B-00-0000-0D00E20DT		
				D4	550	XHP35B-00-0000-0D00D40DT		
		70		E2	590	XHP35B-00-0000-0D0BE20DT		
				D4	550	XHP35B-00-0000-0D0BD40DT		
		80		D4	550	XHP35B-00-0000-0D0HD40DT		
				D2	510	XHP35B-00-0000-0D0HD20DT		
		90		D2	510	XHP35B-00-0000-0D0UD20DT		
				C4	475	XHP35B-00-0000-0D0UC40DT		
		C2	440	XHP35B-00-0000-0D0UC20DT				
		6500 K	1A, 1B, 1C, 1D	0	68	E2	590	XHP35B-00-0000-0D00E20E1
						D4	550	XHP35B-00-0000-0D00D40E1
				70		E2	590	XHP35B-00-0000-0D0BE20E1
D4	550					XHP35B-00-0000-0D0BD40E1		
80				D4	550	XHP35B-00-0000-0D0HD40E1		
				D2	510	XHP35B-00-0000-0D0HD20E1		
90				D2	510	XHP35B-00-0000-0D0UD20E1		
				C4	475	XHP35B-00-0000-0D0UC40E1		
C2	440			XHP35B-00-0000-0D0UC20E1				
6000 K	1A, 1B, 1C, 1D, 1R, 1S, 1T, 1U, 2A, 2B, 2C, 2D, 2R, 2S, 2T, 2U			0	68	E2	590	XHP35B-00-0000-0D00E20DV
						D4	550	XHP35B-00-0000-0D00D40DV
				70		E2	590	XHP35B-00-0000-0D0BE20DV
		D4	550			XHP35B-00-0000-0D0BD40DV		
		80		D4	550	XHP35B-00-0000-0D0HD40DV		
				D2	510	XHP35B-00-0000-0D0HD20DV		
		90		D2	510	XHP35B-00-0000-0D0UD20DV		
				C4	475	XHP35B-00-0000-0D0UC40DV		
		C2	440	XHP35B-00-0000-0D0UC20DV				

**Notes:**

- Cree LED maintains a tolerance of ±7% on flux and power measurements, ±0.005 on chromaticity (CCx, CCy) measurements and ±2 on CRI measurements. See the Measurements section (page 30).
- XLamp XHP35.2 LED order codes specify only a minimum flux bin and not a maximum. Cree LED may ship reels in flux bins higher than the minimum specified by the order code without advance notice. Shipments will always adhere to the chromaticity bin restrictions specified by the order code.

ORDER CODES SUGGESTED FOR NEW DESIGNS - HIGH DENSITY ANSI (T<sub>j</sub> = 85 °C) - CONTINUED

Nominal CCT	Chromaticity Regions	CRI		Minimum Luminous Flux @ 350 mA		Order Code		
		Min	Typ	Group	Flux (lm) @ 85 °C			
5700 K	2A, 2B, 2C, 2D	0	68	E4	635	XHP35B-00-0000-0D00E40E2		
				E2	590	XHP35B-00-0000-0D00E20E2		
		70		E4	635	XHP35B-00-0000-0D00BE40E2		
				E2	590	XHP35B-00-0000-0D00BE20E2		
		80		E2	590	XHP35B-00-0000-0D00HE20E2		
				D4	550	XHP35B-00-0000-0D00HD40E2		
		90		D2	510	XHP35B-00-0000-0D00UD20E2		
				C4	475	XHP35B-00-0000-0D00UC40E2		
				C2	440	XHP35B-00-0000-0D00UC20E2		
		5000 K	3A, 3B, 3C, 3D	0	68	E4	635	XHP35B-00-0000-0D00E40E3
						E2	590	XHP35B-00-0000-0D00E20E3
				70		E4	635	XHP35B-00-0000-0D00BE40E3
E2	590					XHP35B-00-0000-0D00BE20E3		
80				E2	590	XHP35B-00-0000-0D00HE20E3		
				D4	550	XHP35B-00-0000-0D00HD40E3		
90				D2	510	XHP35B-00-0000-0D00UD20E3		
				C4	475	XHP35B-00-0000-0D00UC40E3		
				C2	440	XHP35B-00-0000-0D00UC20E3		
4500 K	4A, 4B, 4C, 4D			0	68	E4	635	XHP35B-00-0000-0D00E40E4
						E2	590	XHP35B-00-0000-0D00E20E4
				70		E4	635	XHP35B-00-0000-0D00BE40E4
		E2	590			XHP35B-00-0000-0D00BE20E4		
		80		E2	590	XHP35B-00-0000-0D00HE20E4		
				D4	550	XHP35B-00-0000-0D00HD40E4		
		90		D2	510	XHP35B-00-0000-0D00UD20E4		
				C4	475	XHP35B-00-0000-0D00UC40E4		
				C2	440	XHP35B-00-0000-0D00UC20E4		

Notes:

- Cree LED maintains a tolerance of ±7% on flux and power measurements, ±0.005 on chromaticity (CCx, CCy) measurements and ±2 on CRI measurements. See the Measurements section (page 30).
- XLamp XHP35.2 LED order codes specify only a minimum flux bin and not a maximum. Cree LED may ship reels in flux bins higher than the minimum specified by the order code without advance notice. Shipments will always adhere to the chromaticity bin restrictions specified by the order code.

ORDER CODES SUGGESTED FOR NEW DESIGNS - HIGH DENSITY ANSI (T<sub>j</sub> = 85 °C) - CONTINUED

Nominal CCT	Chromaticity Regions	CRI		Minimum Luminous Flux @ 350 mA		Order Code		
		Min	Typ	Group	Flux (lm) @ 85 °C			
4000 K	5A, 5B, 5C, 5D	0	68	E4	635	XHP35B-00-0000-0D00E40E5		
				E2	590	XHP35B-00-0000-0D00E20E5		
		70		E4	635	XHP35B-00-0000-0D00BE40E5		
				E2	590	XHP35B-00-0000-0D00BE20E5		
		80		E2	590	XHP35B-00-0000-0D00HE20E5		
				D4	550	XHP35B-00-0000-0D00HD40E5		
		90		C4	475	XHP35B-00-0000-0D00UC40E5		
				C2	440	XHP35B-00-0000-0D00UC20E5		
				B4	410	XHP35B-00-0000-0D00UB40E5		
		3500 K	6A, 6B, 6C, 6D	70		E2	590	XHP35B-00-0000-0D00BE20E6
						D4	550	XHP35B-00-0000-0D00BD40E6
				80		D4	550	XHP35B-00-0000-0D00HD40E6
D2	510					XHP35B-00-0000-0D00HD20E6		
90				C4	475	XHP35B-00-0000-0D00UC40E6		
				C2	440	XHP35B-00-0000-0D00UC20E6		
3000 K	7A, 7B, 7C, 7D	70		E2	590	XHP35B-00-0000-0D00BE20E7		
				D4	550	XHP35B-00-0000-0D00BD40E7		
				D2	510	XHP35B-00-0000-0D00BD20E7		
		80		D4	550	XHP35B-00-0000-0D00HD40E7		
				D2	510	XHP35B-00-0000-0D00HD20E7		
		90		C2	440	XHP35B-00-0000-0D00UC20E7		
B4	410			XHP35B-00-0000-0D00UB40E7				
2700 K	8A, 8B, 8C, 8D	80		D2	510	XHP35B-00-0000-0D00HD20E8		
				C4	475	XHP35B-00-0000-0D00HC40E8		
		90		B4	410	XHP35B-00-0000-0D00UB40E8		
				B2	380	XHP35B-00-0000-0D00UB20E8		

Notes:

- Cree LED maintains a tolerance of ±7% on flux and power measurements, ±0.005 on chromaticity (CCx, CCy) measurements and ±2 on CRI measurements. See the Measurements section (page 30).
- XLamp XHP35.2 LED order codes specify only a minimum flux bin and not a maximum. Cree LED may ship reels in flux bins higher than the minimum specified by the order code without advance notice. Shipments will always adhere to the chromaticity bin restrictions specified by the order code.



**ORDER CODES SUGGESTED FOR NEW DESIGNS - HIGH INTENSITY EASYWHITE® (T<sub>J</sub> = 85 °C)**

The following table provides order codes for XLamp XHP35.2 High-Intensity LEDs. For a complete description of how the flux and chromaticity groups are reflected in the bin code and order code nomenclature, please see the Bin and Order Code Formats section (page 28).

Nominal CCT	CRI		Minimum Luminous Flux @350 mA		2-Step		3-Step		5-Step	
	Min	Typ	Group	Flux (lm) @ 85 °C	Group	Order Code	Group	Order Code	Group	Order Code
5700 K	70		D4	550					57E	XHP35B-H0-0000-0D0BD457E
			D2	510						XHP35B-H0-0000-0D0BD257E
			C4	475						XHP35B-H0-0000-0D0BC457E
	80		D2	510					57E	XHP35B-H0-0000-0D0HD257E
			C4	475						XHP35B-H0-0000-0D0HC457E
			C2	440						XHP35B-H0-0000-0D0HC257E
	90		C4	475					57E	XHP35B-H0-0000-0D0UC457E
			C2	440						XHP35B-H0-0000-0D0UC257E
			B4	410						XHP35B-H0-0000-0D0UB457E
5000 K	70		D4	550					50E	XHP35B-H0-0000-0D0BD450E
			D2	510						XHP35B-H0-0000-0D0BD250E
			C4	475						XHP35B-H0-0000-0D0BC450E
	80		D2	510			50G	XHP35B-H0-0000-0D0HD250G	50E	XHP35B-H0-0000-0D0HD250E
			C4	475			XHP35B-H0-0000-0D0HC450G	XHP35B-H0-0000-0D0HC450E		
			C2	440			XHP35B-H0-0000-0D0HC250G	XHP35B-H0-0000-0D0HC250E		
	90		C2	440	50H	XHP35B-H0-0000-0D0UC250H	50G	XHP35B-H0-0000-0D0UC250G	50E	XHP35B-H0-0000-0D0UC250E
			B4	410		XHP35B-H0-0000-0D0UB450H		XHP35B-H0-0000-0D0UB450G		XHP35B-H0-0000-0D0UB450E
			B2	380		XHP35B-H0-0000-0D0UB250H		XHP35B-H0-0000-0D0UB250G		XHP35B-H0-0000-0D0UB250E

**Notes:**

- Cree LED maintains a tolerance of ±7% on flux and power measurements, ±0.005 on chromaticity (CCx, CCy) measurements and ±2 on CRI measurements. See the Measurements section (page 30).
- XLamp XHP35.2 LED order codes specify only a minimum flux bin and not a maximum. Cree LED may ship reels in flux bins higher than the minimum specified by the order code without advance notice. Shipments will always adhere to the chromaticity bin restrictions specified by the order code.

ORDER CODES SUGGESTED FOR NEW DESIGNS - HIGH INTENSITY EASYWHITE® (T<sub>J</sub> = 85 °C) - CONTINUED

Nominal CCT	CRI		Minimum Luminous Flux @350 mA		2-Step		3-Step		5-Step	
	Min	Typ	Group	Flux (lm) @ 85 °C	Group	Order Code	Group	Order Code	Group	Order Code
4500 K	70		D4	550					45E	XHP35B-H0-0000-0D0BD445E
			D2	510						XHP35B-H0-0000-0D0BD245E
			C4	475						XHP35B-H0-0000-0D0BC445E
	80		D2	510			45G	XHP35B-H0-0000-0D0HD245G	45E	XHP35B-H0-0000-0D0HD245E
			C4	475				XHP35B-H0-0000-0D0HC445G		XHP35B-H0-0000-0D0HC445E
			C2	440				XHP35B-H0-0000-0D0HC245G		XHP35B-H0-0000-0D0HC245E
	90		C2	440	45H	XHP35B-H0-0000-0D0UC245H	45G	XHP35B-H0-0000-0D0UC245G	45E	XHP35B-H0-0000-0D0UC245E
			B4	410		XHP35B-H0-0000-0D0UB445H		XHP35B-H0-0000-0D0UB445G		XHP35B-H0-0000-0D0UB445E
			B2	380		XHP35B-H0-0000-0D0UB245H		XHP35B-H0-0000-0D0HB245G		XHP35B-H0-0000-0D0UB245E
4000 K	70		D4	550					40E	XHP35B-H0-0000-0D0BD440E
			D2	510						XHP35B-H0-0000-0D0BD240E
			C4	475						XHP35B-H0-0000-0D0BC440E
			C2	440						XHP35B-H0-0000-0D0BC240E
	80		D2	510			40G	XHP35B-H0-0000-0D0HD240G	40E	XHP35B-H0-0000-0D0HD240E
			C4	475				XHP35B-H0-0000-0D0HC440G		XHP35B-H0-0000-0D0HC440E
			C2	440				XHP35B-H0-0000-0D0HC240G		XHP35B-H0-0000-0D0HC240E
	90		B4	410	40H	XHP35B-H0-0000-0D0UB440H	40G	XHP35B-H0-0000-0D0UB440G	40E	XHP35B-H0-0000-0D0UB440E
			B2	380		XHP35B-H0-0000-0D0UB240H		XHP35B-H0-0000-0D0UB240G		XHP35B-H0-0000-0D0UB240E
A4			355	XHP35B-H0-0000-0D0UA440H		XHP35B-H0-0000-0D0UA440G		XHP35B-H0-0000-0D0UA440E		

Notes:

- Cree LED maintains a tolerance of ±7% on flux and power measurements, ±0.005 on chromaticity (CCx, CCy) measurements and ±2 on CRI measurements. See the Measurements section (page 30).
- XLamp XHP35.2 LED order codes specify only a minimum flux bin and not a maximum. Cree LED may ship reels in flux bins higher than the minimum specified by the order code without advance notice. Shipments will always adhere to the chromaticity bin restrictions specified by the order code.

ORDER CODES SUGGESTED FOR NEW DESIGNS - HIGH INTENSITY EASYWHITE® (T<sub>J</sub> = 85 °C) - CONTINUED

Nominal CCT	CRI		Minimum Luminous Flux @350 mA		2-Step		3-Step		5-Step	
	Min	Typ	Group	Flux (lm) @ 85 °C	Group	Order Code	Group	Order Code	Group	Order Code
3500 K	70		D2	510					35E	XHP35B-H0-0000-0D0BD235E
			C4	475						XHP35B-H0-0000-0D0BC435E
			C2	440						XHP35B-H0-0000-0D0BC235E
	80		C4	475			35G	XHP35B-H0-0000-0D0HC435G	35E	XHP35B-H0-0000-0D0HC435E
			C2	440				XHP35B-H0-0000-0D0HC235G		XHP35B-H0-0000-0D0HC235E
			B4	410				XHP35B-H0-0000-0D0HB435G		XHP35B-H0-0000-0D0HB435E
	90		B4	410	35H	XHP35B-H0-0000-0D0UB435H	35G	XHP35B-H0-0000-0D0UB435G	35E	XHP35B-H0-0000-0D0UB435E
			B2	380		XHP35B-H0-0000-0D0UB235H		XHP35B-H0-0000-0D0UB235G		XHP35B-H0-0000-0D0UB235E
			A4	355		XHP35B-H0-0000-0D0UA435H		XHP35B-H0-0000-0D0UA435G		XHP35B-H0-0000-0D0UA435E
3000 K	70		D2	510					30E	XHP35B-H0-0000-0D0BD230E
			C4	475						XHP35B-H0-0000-0D0BC430E
			C2	440						XHP35B-H0-0000-0D0BC230E
	80		C4	475			30G	XHP35B-H0-0000-0D0HC430G	30E	XHP35B-H0-0000-0D0HC430E
			C2	440				XHP35B-H0-0000-0D0HC230G		XHP35B-H0-0000-0D0HC230E
			B4	410				XHP35B-H0-0000-0D0HB430G		XHP35B-H0-0000-0D0HB430E
	90		B4	410	30H	XHP35B-H0-0000-0D0UB430H	30G	XHP35B-H0-0000-0D0UB430G	30E	XHP35B-H0-0000-0D0UB430E
			B2	380		XHP35B-H0-0000-0D0UB230H		XHP35B-H0-0000-0D0UB230G		XHP35B-H0-0000-0D0UB230E
			A4	355		XHP35B-H0-0000-0D0UA430H		XHP35B-H0-0000-0D0UA430G		XHP35B-H0-0000-0D0UA430E

Notes:

- Cree LED maintains a tolerance of ±7% on flux and power measurements, ±0.005 on chromaticity (CCx, CCy) measurements and ±2 on CRI measurements. See the Measurements section (page 30).
- XLamp XHP35.2 LED order codes specify only a minimum flux bin and not a maximum. Cree LED may ship reels in flux bins higher than the minimum specified by the order code without advance notice. Shipments will always adhere to the chromaticity bin restrictions specified by the order code.

ORDER CODES SUGGESTED FOR NEW DESIGNS - HIGH INTENSITY EASYWHITE® (T<sub>J</sub> = 85 °C) - CONTINUED

Nominal CCT	CRI		Minimum Luminous Flux @350 mA		2-Step		3-Step		5-Step	
	Min	Typ	Group	Flux (lm) @ 85 °C	Group	Order Code	Group	Order Code	Group	Order Code
2700 K	80		C2	440			27G	XHP35B-H0-0000-0D0HC227G	27E	XHP35B-H0-0000-0D0HC227E
			B4	410				XHP35B-H0-0000-0D0HB427G		XHP35B-H0-0000-0D0HB427E
			B2	380				XHP35B-H0-0000-0D0HB227G		XHP35B-H0-0000-0D0HB227E
	90		B2	380	27H	XHP35B-H0-0000-0D0UB227H	27G	XHP35B-H0-0000-0D0UB227G	27E	XHP35B-H0-0000-0D0UB227E
			A4	355		XHP35B-H0-0000-0D0UA427H		XHP35B-H0-0000-0D0UA427G		XHP35B-H0-0000-0D0UA427E
			A2	330		XHP35B-H0-0000-0D0UA227H		XHP35B-H0-0000-0D0UA227G		XHP35B-H0-0000-0D0UA227E

**Notes:**

- Cree LED maintains a tolerance of ±7% on flux and power measurements, ±0.005 on chromaticity (CCx, CCy) measurements and ±2 on CRI measurements. See the Measurements section (page 30).
- XLamp XHP35.2 LED order codes specify only a minimum flux bin and not a maximum. Cree LED may ship reels in flux bins higher than the minimum specified by the order code without advance notice. Shipments will always adhere to the chromaticity bin restrictions specified by the order code.

**ORDER CODES SUGGESTED FOR NEW DESIGNS - HIGH INTENSITY ANSI (T<sub>j</sub> = 85 °C)**

The following table provides order codes for XLamp XHP35.2 High-Intensity LEDs. For a complete description of how the flux and chromaticity groups are reflected in the bin code and order code nomenclature, please see the Bin and Order Code Formats section (page 28).

Nominal CCT	Chromaticity Regions	CRI		Minimum Luminous Flux @ 350 mA		Order Code
		Min	Typ	Group	Flux (lm) @ 85 °C	
7000- K	0A, 0B, 0C, 0D, 0R, 0S, 0T, 0U, 1A, 1B, 1C, 1D, 1R, 1S, 1T, 1U	80		D2	510	XHP35B-H0-0000-0D0HD20DV
6500 K	1A, 1B, 1C, 1D	70		D4	550	XHP35B-H0-0000-0D0BD40E1
				D2	510	XHP35B-H0-0000-0D0BD20E1
				C4	475	XHP35B-H0-0000-0D0BC40E1
		80		D2	510	XHP35B-H0-0000-0D0HD20E1
				C4	475	XHP35B-H0-0000-0D0HC40E1
				C2	440	XHP35B-H0-0000-0D0HC20E1
		90		C4	475	XHP35B-H0-0000-0D0UC40E1
				C2	440	XHP35B-H0-0000-0D0UC20E1
				B4	410	XHP35B-H0-0000-0D0UB40E1
5700 K	2A, 2B, 2C, 2D	70		D4	550	XHP35B-H0-0000-0D0BD40E2
				D2	510	XHP35B-H0-0000-0D0BD20E2
				C4	475	XHP35B-H0-0000-0D0BC40E2
		80		D2	510	XHP35B-H0-0000-0D0HD20E2
				C4	475	XHP35B-H0-0000-0D0HC40E2
				C2	440	XHP35B-H0-0000-0D0HC20E2
		90		C4	475	XHP35B-H0-0000-0D0UC40E2
				C2	440	XHP35B-H0-0000-0D0UC20E2
				B4	410	XHP35B-H0-0000-0D0UB40E2
5000 K	3A, 3B, 3C, 3D	70		D4	550	XHP35B-H0-0000-0D0BD40E3
				D2	510	XHP35B-H0-0000-0D0BD20E3
				C4	475	XHP35B-H0-0000-0D0BC40E3
		80		D2	510	XHP35B-H0-0000-0D0HD20E3
				C4	475	XHP35B-H0-0000-0D0HC40E3
				C2	440	XHP35B-H0-0000-0D0HC20E3
		90		C2	440	XHP35B-H0-0000-0D0UC20E3
				B4	410	XHP35B-H0-0000-0D0UB40E3
				B2	380	XHP35B-H0-0000-0D0UB20E3

**Notes:**

- Cree LED maintains a tolerance of ±7% on flux and power measurements, ±0.005 on chromaticity (CCx, CCy) measurements and ±2 on CRI measurements. See the Measurements section (page 30).
- XLamp XHP35.2 LED order codes specify only a minimum flux bin and not a maximum. Cree LED may ship reels in flux bins higher than the minimum specified by the order code without advance notice. Shipments will always adhere to the chromaticity bin restrictions specified by the order code.

ORDER CODES SUGGESTED FOR NEW DESIGNS - HIGH INTENSITY ANSI (T<sub>j</sub> = 85 °C) - CONTINUED

Nominal CCT	Chromaticity Regions	CRI		Minimum Luminous Flux @ 350 mA		Order Code
		Min	Typ	Group	Flux (lm) @ 85 °C	
4500 K	4A, 4B, 4C, 4D	70		D4	550	XHP35B-H0-0000-0D0BD40E4
				D2	510	XHP35B-H0-0000-0D0BD20E4
				C4	475	XHP35B-H0-0000-0D0BC40E4
		80		D2	510	XHP35B-H0-0000-0D0HD20E4
				C4	475	XHP35B-H0-0000-0D0HC40E4
				C2	440	XHP35B-H0-0000-0D0HC20E4
		90		C2	440	XHP35B-H0-0000-0D0UC20E4
				B4	410	XHP35B-H0-0000-0D0UB40E4
				B2	380	XHP35B-H0-0000-0D0UB20E4
4000 K	5A, 5B, 5C, 5D	70		D4	550	XHP35B-H0-0000-0D0BD40E5
				D2	510	XHP35B-H0-0000-0D0BD20E5
				C4	475	XHP35B-H0-0000-0D0BC40E5
				C2	440	XHP35B-H0-0000-0D0BC20E5
		80		D2	510	XHP35B-H0-0000-0D0HD20E5
				C4	475	XHP35B-H0-0000-0D0HC40E5
				C2	440	XHP35B-H0-0000-0D0HC20E5
		90		B4	410	XHP35B-H0-0000-0D0UB40E5
				B2	380	XHP35B-H0-0000-0D0UB20E5
		A4	355	XHP35B-H0-0000-0D0UA40E5		
3500 K	6A, 6B, 6C, 6D	70		D2	510	XHP35B-H0-0000-0D0BD20E6
				C4	475	XHP35B-H0-0000-0D0BC40E6
				C2	440	XHP35B-H0-0000-0D0BC20E6
		80		C4	475	XHP35B-H0-0000-0D0HC40E6
				C2	440	XHP35B-H0-0000-0D0HC20E6
				B4	410	XHP35B-H0-0000-0D0HB40E6
		90		B4	410	XHP35B-H0-0000-0D0UB40E6
				B2	380	XHP35B-H0-0000-0D0UB20E6
				A4	355	XHP35B-H0-0000-0D0UA40E6

Notes:

- Cree LED maintains a tolerance of ±7% on flux and power measurements, ±0.005 on chromaticity (CC<sub>x</sub>, CC<sub>y</sub>) measurements and ±2 on CRI measurements. See the Measurements section (page 30).
- XLamp XHP35.2 LED order codes specify only a minimum flux bin and not a maximum. Cree LED may ship reels in flux bins higher than the minimum specified by the order code without advance notice. Shipments will always adhere to the chromaticity bin restrictions specified by the order code.

ORDER CODES SUGGESTED FOR NEW DESIGNS - HIGH INTENSITY ANSI (T<sub>j</sub> = 85 °C) - CONTINUED

Nominal CCT	Chromaticity Regions	CRI		Minimum Luminous Flux @ 350 mA		Order Code
		Min	Typ	Group	Flux (lm) @ 85 °C	
3000 K	7A, 7B, 7C, 7D	70		D2	510	XHP35B-H0-0000-0D0BD20E7
				C4	475	XHP35B-H0-0000-0D0BC40E7
				C2	440	XHP35B-H0-0000-0D0BC20E7
		80		C4	475	XHP35B-H0-0000-0D0HC20E7
				C2	440	XHP35B-H0-0000-0D0HB40E7
				B4	410	XHP35B-H0-0000-0D0HB20E7
		90		B4	410	XHP35B-H0-0000-0D0UB40E7
				B2	380	XHP35B-H0-0000-0D0UB20E7
				A4	355	XHP35B-H0-0000-0D0UA40E7
2700 K	8A, 8B, 8C, 8D	80		C2	440	XHP35B-H0-0000-0D0HC20E8
				B4	410	XHP35B-H0-0000-0D0HB40E8
				B2	380	XHP35B-H0-0000-0D0HB20E8
		90		B2	380	XHP35B-H0-0000-0D0UB20E8
				A4	355	XHP35B-H0-0000-0D0UA40E8
				A2	330	XHP35B-H0-0000-0D0UA20E8

**Notes:**

- Cree LED maintains a tolerance of ±7% on flux and power measurements, ±0.005 on chromaticity (CCx, CCy) measurements and ±2 on CRI measurements. See the Measurements section (page 30).
- XLamp XHP35.2 LED order codes specify only a minimum flux bin and not a maximum. Cree LED may ship reels in flux bins higher than the minimum specified by the order code without advance notice. Shipments will always adhere to the chromaticity bin restrictions specified by the order code.

RELATIVE SPECTRAL POWER DISTRIBUTION

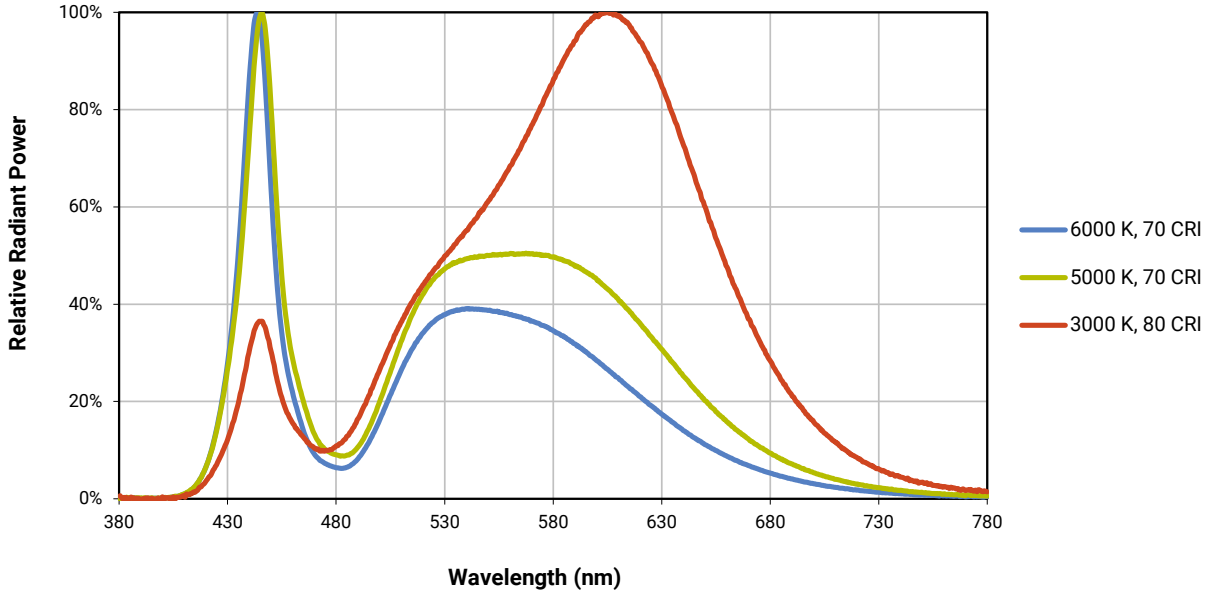

RELATIVE FLUX VS. JUNCTION TEMPERATURE ( $I_f = 350 \text{ mA}$ )

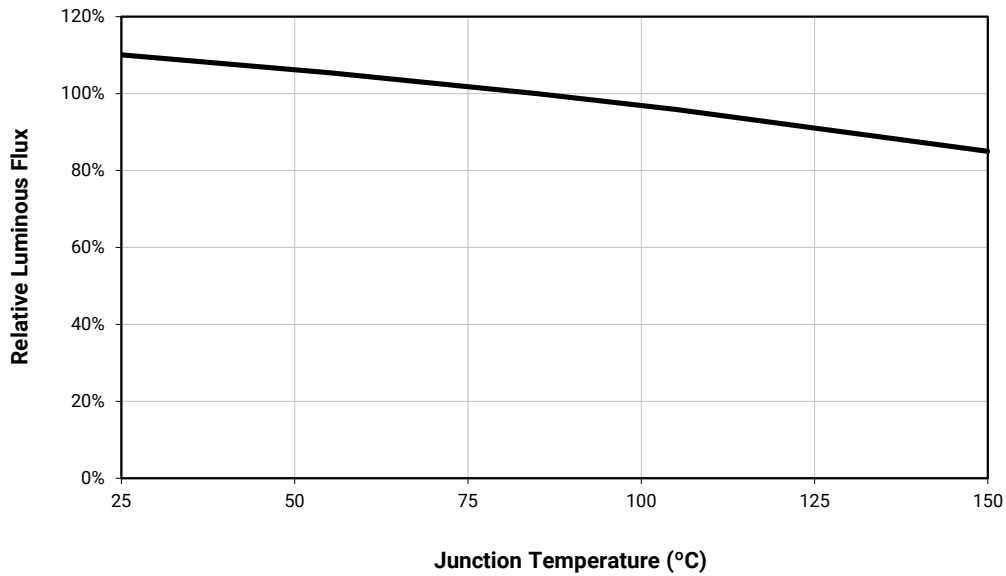



ELECTRICAL CHARACTERISTICS ( $T_j = 85\text{ }^\circ\text{C}$ )

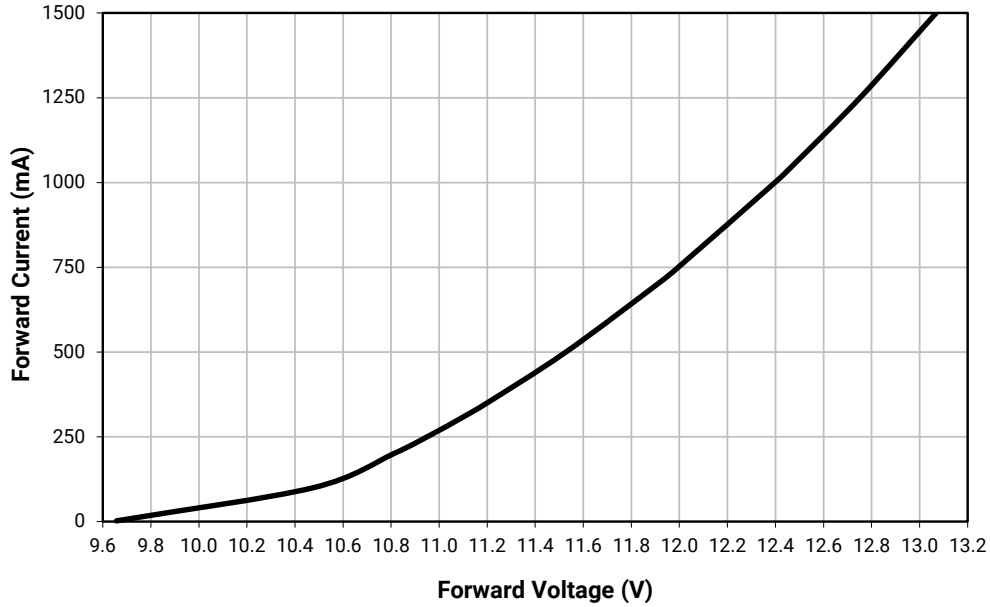

RELATIVE FLUX VS. CURRENT ( $T_j = 85\text{ }^\circ\text{C}$ )

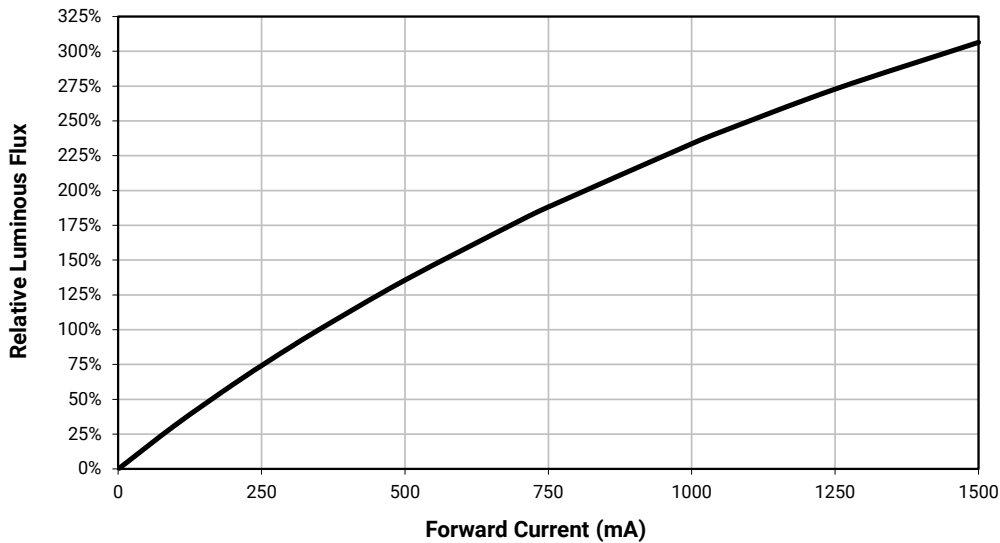

RELATIVE CHROMATICITY VS. CURRENT (WARM WHITE)

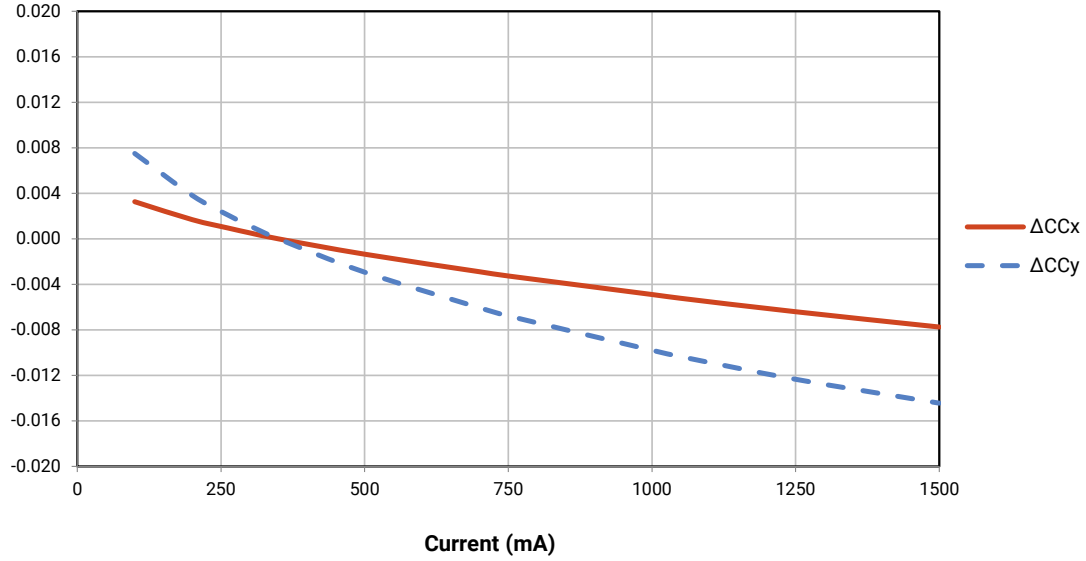

RELATIVE CHROMATICITY VS. TEMPERATURE (WARM WHITE)

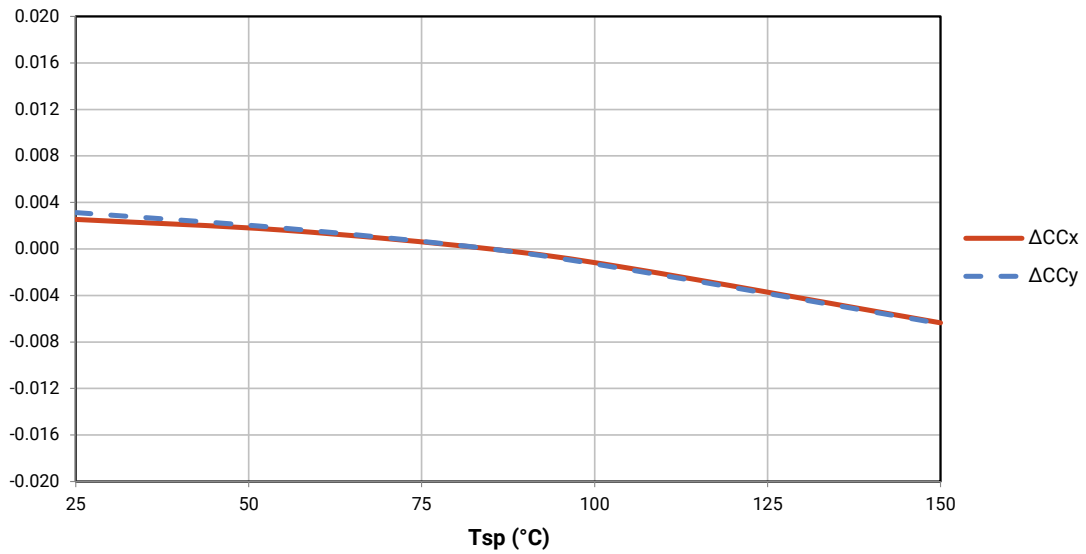

### TYPICAL SPATIAL DISTRIBUTION

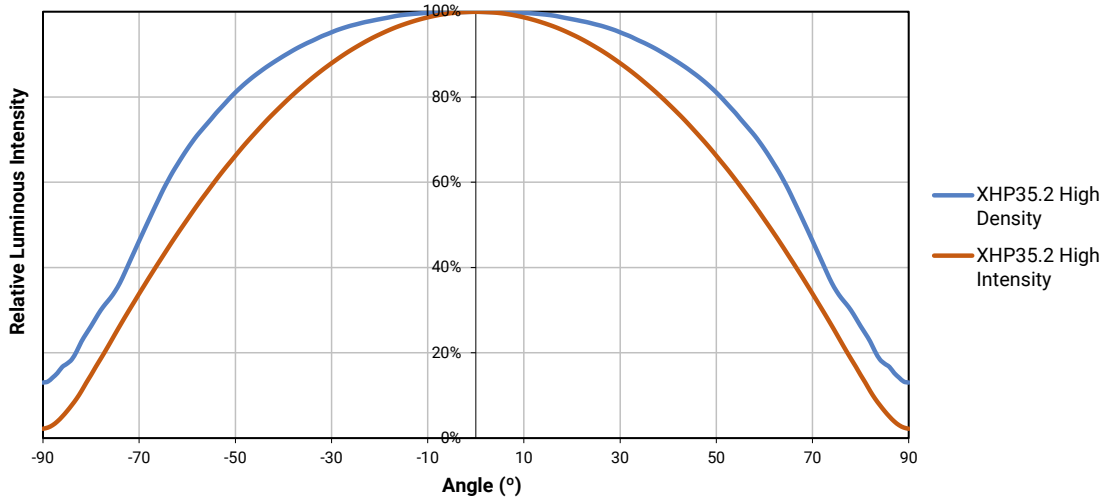

### THERMAL DESIGN

The maximum forward current is determined by the thermal resistance between the LED junction and ambient. It is crucial for the end product to be designed in a manner that minimizes the thermal resistance from the solder point to ambient in order to optimize lamp life and optical characteristics.

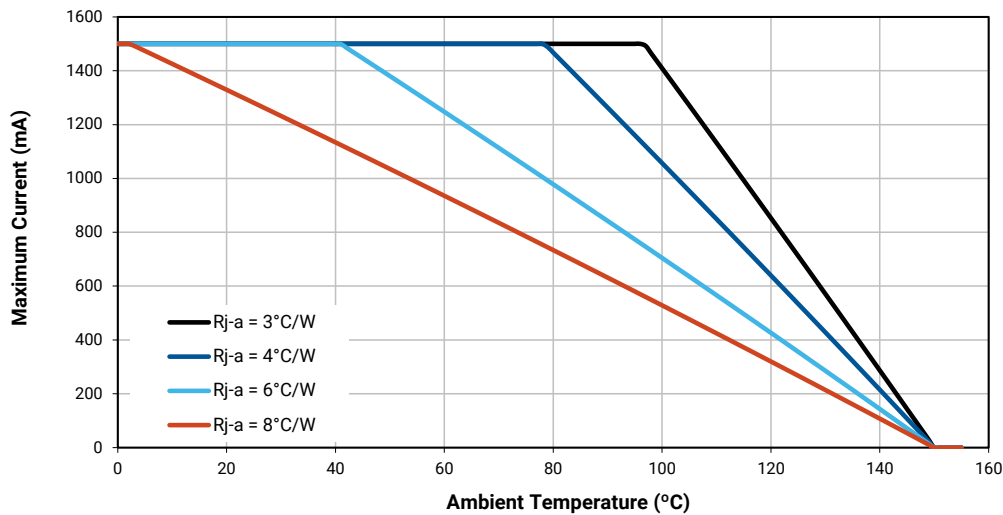

## PERFORMANCE GROUPS – LUMINOUS FLUX ( $T_j = 85\text{ }^\circ\text{C}$ )

XLamp XHP35.2 LEDs are tested for luminous flux and placed into one of the following luminous-flux groups.

Group Code	Minimum Luminous Flux (lm) @ 350 mA	Maximum Luminous Flux (lm) @ 350 mA
A2	330	355
A4	355	380
B2	380	410
B4	410	440
C2	440	475
C4	475	510
D2	510	550
D4	550	590
E2	590	635
E4	635	680

## PERFORMANCE GROUPS – CHROMATICITY

XLamp XHP35.2 LEDs are tested for chromaticity and placed into one of the regions defined by the following bounding coordinates.

EasyWhite Color Temperatures – 2-Step			
Bin Code	CCT	x	y
50H	5000 K	0.3429	0.3507
		0.3434	0.3571
		0.3475	0.3604
		0.3469	0.3539
45H	4500 K	0.3643	0.3720
		0.3597	0.3689
		0.3587	0.3620
		0.3628	0.3647
40H	4000 K	0.3777	0.3739
		0.3797	0.3816
		0.3861	0.3855
		0.3838	0.3777
35H	3500 K	0.4022	0.3858
		0.4053	0.3942
		0.4125	0.3977
		0.4091	0.3891
30H	3000 K	0.4287	0.3975
		0.4328	0.4064
		0.4390	0.4086
		0.4347	0.3996
27H	2700 K	0.4524	0.4048
		0.4574	0.4140
		0.4633	0.4154
		0.4581	0.4062

EasyWhite Color Temperatures – 3-Step Ellipse						
Bin Code	CCT	Center Point		Major Axis	Minor Axis	Rotation Angle (°)
		x	y	a	b	
50G	5000 K	0.3447	0.3553	0.00840	0.00312	65.0
45G	4500 K	0.3611	0.3658	0.00852	0.00330	61.5
40G	4000 K	0.3818	0.3797	0.00939	0.00402	53.7
35G	3500 K	0.4073	0.3917	0.00927	0.00414	54.0
30G	3000 K	0.4338	0.4030	0.00834	0.00408	53.2
27G	2700 K	0.4577	0.4099	0.00834	0.00420	48.5

PERFORMANCE GROUPS – CHROMATICITY (CONTINUED)

EasyWhite Color Temperatures – 5-Step Ellipse						
Bin Code	CCT	Center Point		Major Axis	Minor Axis	Rotation Angle (°)
		x	y	a	b	
57E	5700 K	0.3287	0.3417	0.01230	0.00600	72.0
50E	5000 K	0.3447	0.3553	0.01400	0.00520	65.0
45E	4500 K	0.3611	0.3658	0.01420	0.00550	61.5
40E	4000 K	0.3818	0.3797	0.01565	0.00670	53.7
35E	3500 K	0.4073	0.3917	0.01545	0.00690	54.0
30E	3000 K	0.4338	0.4030	0.01390	0.00680	53.2
27E	2700 K	0.4577	0.4099	0.01350	0.00700	48.5

ANSI White Bins			
CCT	Bin Code	x	y
7000 K	0A0	0.2950	0.2970
		0.2920	0.3060
		0.2984	0.3133
		0.3009	0.3042
	0B0	0.2920	0.3060
		0.2895	0.3135
		0.2962	0.3220
		0.2984	0.3133
	0C0	0.2984	0.3133
		0.2962	0.3220
		0.3028	0.3304
		0.3048	0.3207
	0D0	0.2984	0.3133
		0.3048	0.3207
		0.3068	0.3113
		0.3009	0.3042

ANSI White Bins			
CCT	Bin Code	x	y
7000 K	0R0	0.2980	0.2880
		0.2950	0.2970
		0.3009	0.3042
		0.3037	0.2937
	0S0	0.2895	0.3135
		0.2870	0.3210
		0.2937	0.3312
		0.2962	0.3220
	0T0	0.2962	0.3220
		0.2937	0.3312
		0.3005	0.3415
		0.3028	0.3304
	0U0	0.3037	0.2937
		0.3009	0.3042
		0.3068	0.3113
		0.3093	0.2993

ANSI White Bins			
CCT	Bin Code	x	y
7000 K	1A0	0.3048	0.3207
		0.3130	0.3290
		0.3144	0.3186
		0.3068	0.3113
	1B0	0.3028	0.3304
		0.3115	0.3391
		0.3130	0.3290
		0.3048	0.3207
	1C0	0.3115	0.3391
		0.3205	0.3481
		0.3213	0.3373
		0.3130	0.3290
	1D0	0.3130	0.3290
		0.3213	0.3373
		0.3221	0.3261
		0.3144	0.3186

PERFORMANCE GROUPS – CHROMATICITY (CONTINUED)

ANSI White Bins			
CCT	Bin Code	x	y
7000 K	1R0	0.3068	0.3113
		0.3144	0.3186
		0.3161	0.3059
		0.3093	0.2993
	1S0	0.3005	0.3415
		0.3099	0.3509
		0.3115	0.3391
		0.3028	0.3304
	1T0	0.3099	0.3509
		0.3196	0.3602
		0.3205	0.3481
		0.3115	0.3391
	1U0	0.3144	0.3186
		0.3221	0.3261
		0.3231	0.3120
		0.3161	0.3059

ANSI White Bins			
CCT	Bin Code	x	y
6000 K	2A0	0.3215	0.3350
		0.3290	0.3417
		0.3290	0.3300
		0.3222	0.3243
	2B0	0.3207	0.3462
		0.3290	0.3538
		0.3290	0.3417
		0.3215	0.3350
	2C0	0.3290	0.3538
		0.3376	0.3616
		0.3371	0.3490
		0.3290	0.3417
	2D0	0.3290	0.3417
		0.3371	0.3490
		0.3366	0.3369
		0.3290	0.3300

ANSI White Bins			
CCT	Bin Code	x	y
6000 K	2R0	0.3222	0.3243
		0.3290	0.3300
		0.3290	0.3180
		0.3231	0.3120
	2S0	0.3196	0.3602
		0.3290	0.3690
		0.3290	0.3538
		0.3207	0.3462
	2T0	0.3290	0.3690
		0.3381	0.3762
		0.3376	0.3616
		0.3290	0.3538
	2U0	0.3290	0.3300
		0.3366	0.3369
		0.3361	0.3245
		0.3290	0.3180

ANSI White Bins			
CCT	Bin Code	x	y
5000 K	3A0	0.3371	0.3490
		0.3451	0.3554
		0.3440	0.3427
		0.3366	0.3369
	3B0	0.3376	0.3616
		0.3463	0.3687
		0.3451	0.3554
		0.3371	0.3490
	3C0	0.3463	0.3687
		0.3551	0.3760
		0.3533	0.3620
		0.3451	0.3554
	3D0	0.3451	0.3554
		0.3533	0.3620
		0.3515	0.3487
		0.3440	0.3427

ANSI White Bins			
CCT	Bin Code	x	y
4500 K	4A0	0.3530	0.3597
		0.3615	0.3659
		0.3512	0.3465
		0.3515	0.3487
	4B0	0.3548	0.3736
		0.3641	0.3804
		0.3530	0.3597
		0.3533	0.362
	4C0	0.3641	0.3804
		0.3736	0.3874
		0.3702	0.3722
		0.3615	0.3659
	4D0	0.3615	0.3659
		0.3702	0.3722
		0.3670	0.3578
		0.3590	0.3521

ANSI White Bins			
CCT	Bin Code	x	y
4000 K	5A0	0.3670	0.3578
		0.3702	0.3722
		0.3825	0.3798
		0.3783	0.3646
	5B0	0.3702	0.3722
		0.3736	0.3874
		0.3869	0.3958
		0.3825	0.3798
	5C0	0.3825	0.3798
		0.3869	0.3958
		0.4006	0.4044
		0.3950	0.3875
	5D0	0.3783	0.3646
		0.3825	0.3798
		0.3950	0.3875
		0.3898	0.3716

PERFORMANCE GROUPS – CHROMATICITY (CONTINUED)

ANSI White Bins			
CCT	Bin Code	x	y
3500 K	6A0	0.3889	0.3690
		0.3941	0.3848
		0.4080	0.3916
		0.4017	0.3751
	6B0	0.3941	0.3848
		0.3996	0.4015
		0.4146	0.4089
		0.4080	0.3916
	6C0	0.4080	0.3916
		0.4146	0.4089
		0.4299	0.4165
		0.4221	0.3984
	6D0	0.4017	0.3751
		0.4080	0.3916
		0.4221	0.3984
		0.4147	0.3814

ANSI White Bins			
CCT	Bin Code	x	y
3000 K	7A0	0.4147	0.3814
		0.4221	0.3984
		0.4342	0.4028
		0.4259	0.3853
	7B0	0.4221	0.3984
		0.4299	0.4165
		0.4430	0.4212
		0.4342	0.4028
	7C0	0.4342	0.4028
		0.4430	0.4212
		0.4562	0.4260
		0.4465	0.4071
	7D0	0.4259	0.3853
		0.4342	0.4028
		0.4465	0.4071
		0.4373	0.3893

ANSI White Bins			
CCT	Bin Code	x	y
2700 K	8A0	0.4373	0.3893
		0.4465	0.4071
		0.4582	0.4099
		0.4483	0.3919
	8B0	0.4465	0.4071
		0.4562	0.4260
		0.4687	0.4289
		0.4582	0.4099
	8C0	0.4582	0.4099
		0.4687	0.4289
		0.4813	0.4319
		0.4700	0.4126
	8D0	0.4483	0.3919
		0.4582	0.4099
		0.4700	0.4126
		0.4593	0.3944



EASYWHITE® CHROMATICITY REGIONS PLOTTED ON THE 1931 CIE CURVE

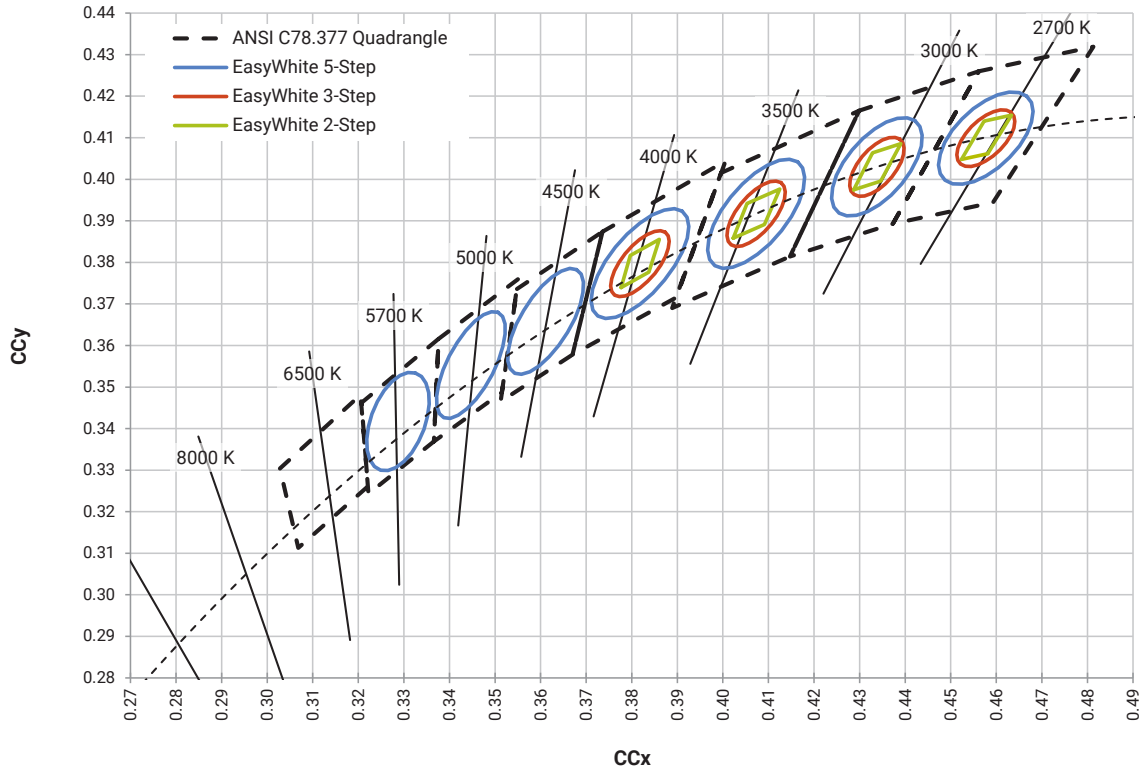

XHP35.2 High Density

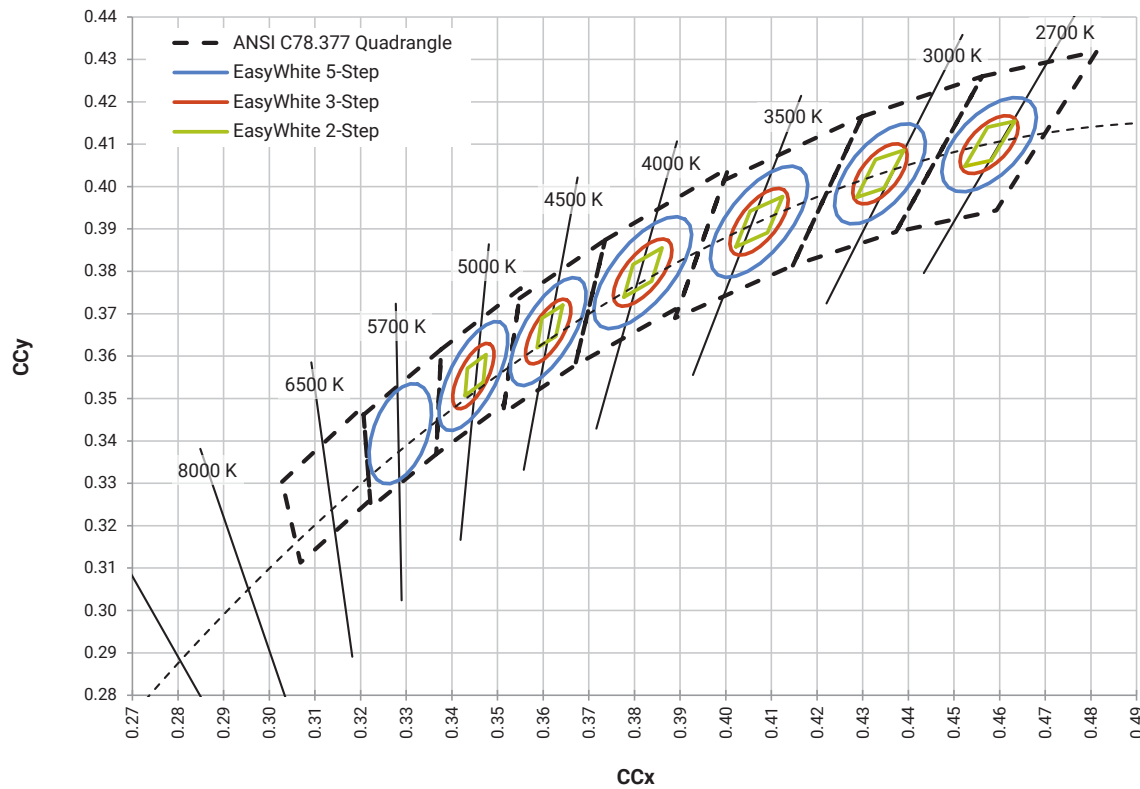

XHP35.2 High Intensity

STANDARD COOL WHITE KITS PLOTTED ON ANSI STANDARD CHROMATICITY REGIONS

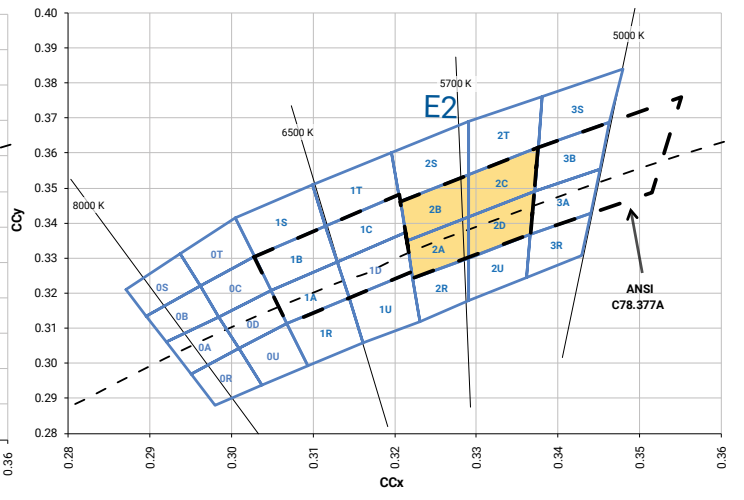
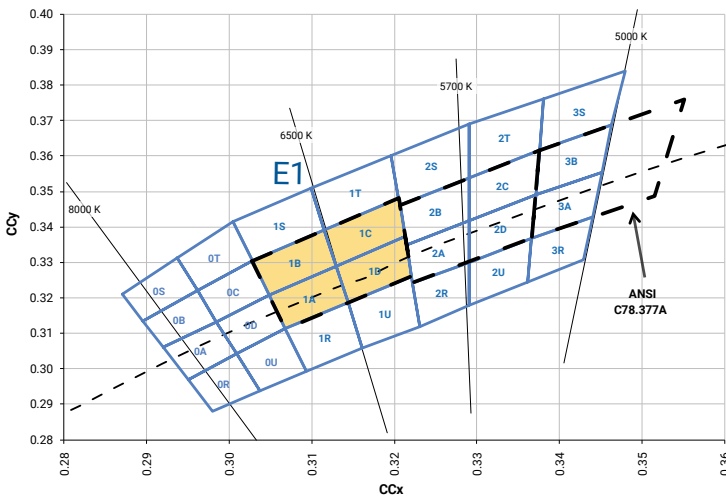
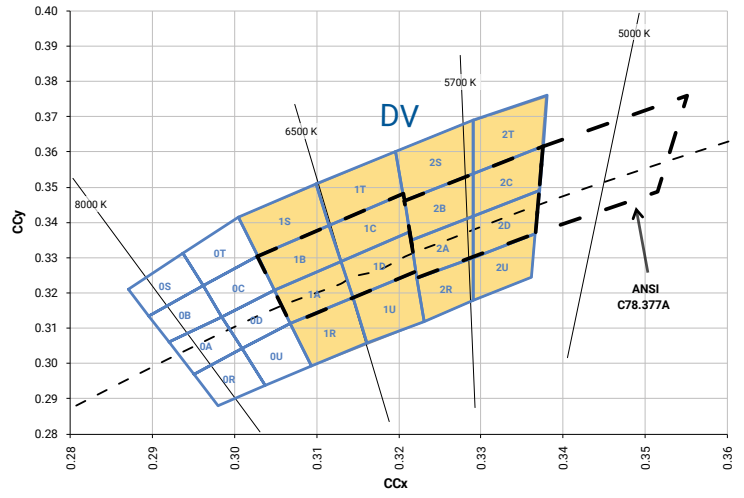
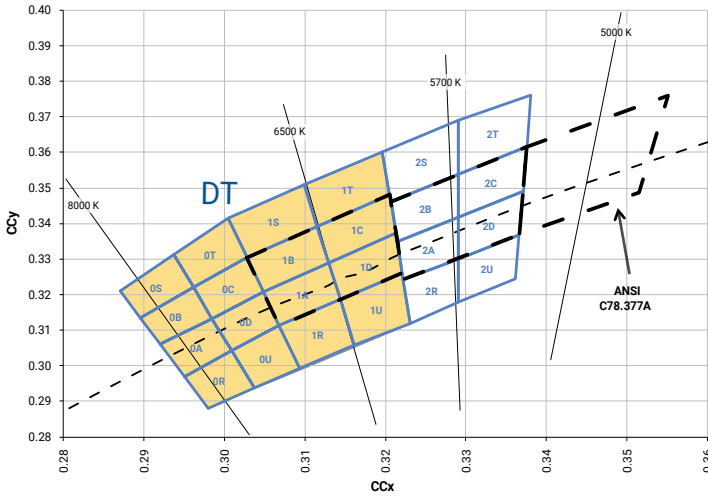

STANDARD WARM AND NEUTRAL WHITE KITS PLOTTED ON ANSI STANDARD CHROMATICITY REGIONS

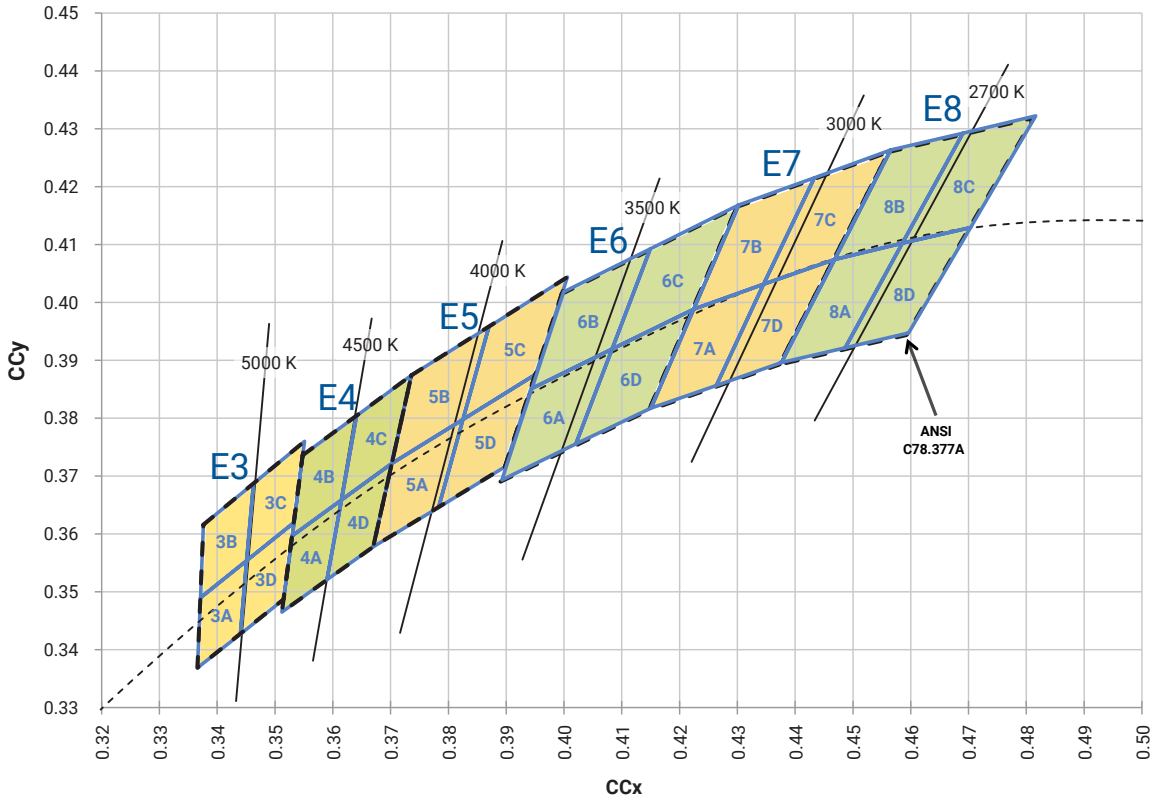

## BIN AND ORDER CODE FORMATS

Bin codes and order codes for XHP35.2 LEDs are configured in the following manner:

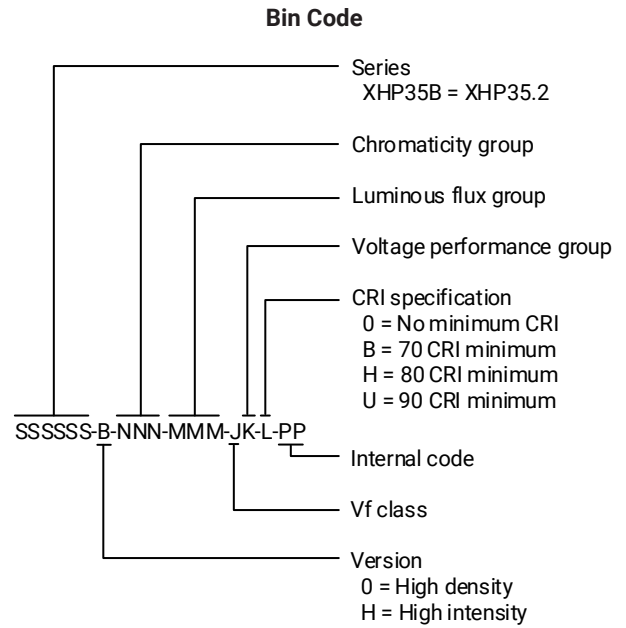
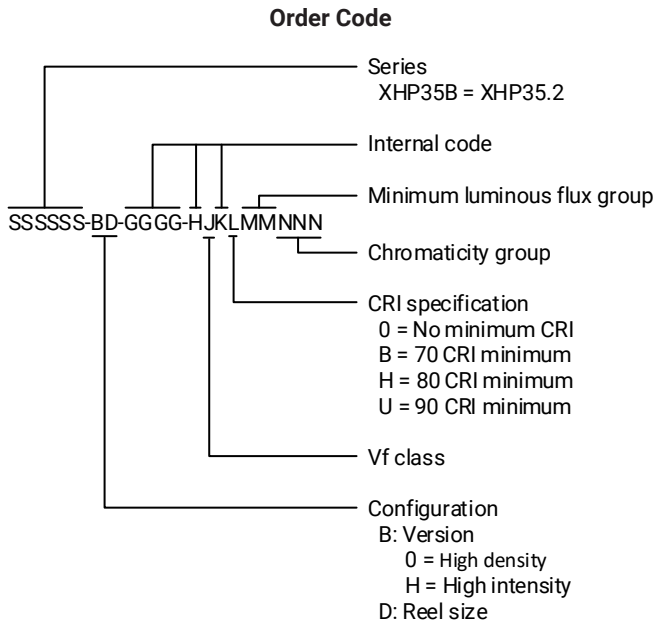

## REFLOW SOLDERING CHARACTERISTICS

In testing, Cree LED has found XLamp XHP35.2 LEDs to be compatible with JEDEC J-STD-020C, using the parameters listed below. As a general guideline, Cree LED recommends that users follow the recommended soldering profile provided by the manufacturer of the solder paste used, and therefore it is the lamp or luminaire manufacturer’s responsibility to determine applicable soldering requirements.

Note that this general guideline may not apply to all PCB designs and configurations of reflow soldering equipment.

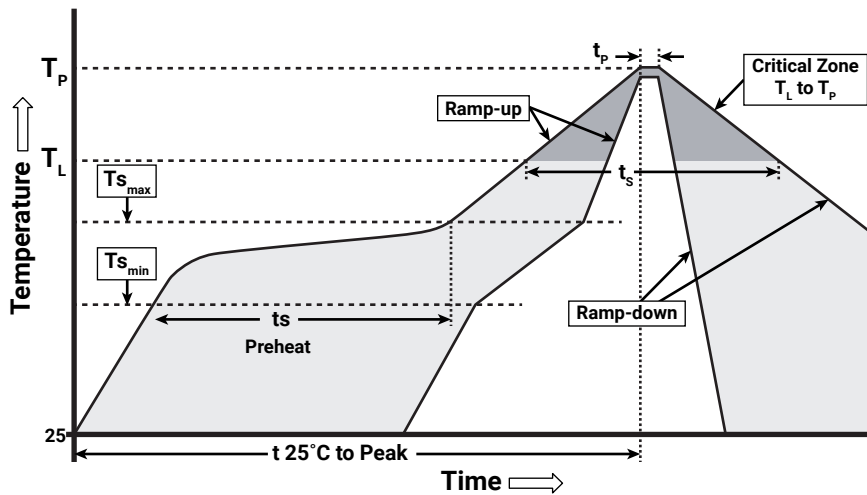

IPC/JEDEC J-STD-020C

Profile Feature	Lead-Free Solder
Average Ramp-Up Rate ( $T_{s_{max}}$ to $T_P$ )	1.2 °C/second
Preheat: Temperature Min ( $T_{s_{min}}$ )	120 °C
Preheat: Temperature Max ( $T_{s_{max}}$ )	170 °C
Preheat: Time ( $t_{s_{min}}$ to $t_{s_{max}}$ )	65-150 seconds
Time Maintained Above: Temperature ( $T_L$ )	217 °C
Time Maintained Above: Time ( $t_L$ )	45-90 seconds
Peak/Classification Temperature ( $T_P$ )	235 - 245 °C
Time Within 5 °C of Actual Peak Temperature ( $t_p$ )	20-40 seconds
Ramp-Down Rate	1 - 6 °C/second
Time 25 °C to Peak Temperature	4 minutes max.

Note: All temperatures refer to the topside of the package, measured on the package body surface.

## NOTES

---

### Measurements

The luminous flux, radiant power, chromaticity, forward voltage and CRI measurements in this document are binning specifications only and solely represent product measurements as of the date of shipment. These measurements will change over time based on a number of factors that are not within Cree LED's control and are not intended or provided as operational specifications for the products. Calculated values are provided for informational purposes only and are not intended or provided as specifications.

### Pre-Release Qualification Testing

Please read the [LED Reliability Overview](#) for details of the qualification process Cree LED applies to ensure long-term reliability for XLamp LEDs and details of Cree LED's pre-release qualification testing for XLamp LEDs.

### Lumen Maintenance

Cree LED now uses standardized IES LM-80-08 and TM-21-11 methods for collecting long-term data and extrapolating LED lumen maintenance. For information on the specific LM-80 data sets available for this LED, refer to the public [LM-80 results document](#).

Please read the [Long-Term Lumen Maintenance application note](#) for more details on Cree LED's lumen maintenance testing and forecasting. Please read the [Thermal Management application note](#) for details on how thermal design, ambient temperature, and drive current affect the LED junction temperature.

### Moisture Sensitivity

Cree LED recommends keeping XLamp LEDs in the provided, resealable moisture-barrier packaging (MBP) until immediately prior to soldering. Unopened MBPs that contain XLamp LEDs do not need special storage for moisture sensitivity.

Once the MBP is opened, XLamp XHP35.2 LEDs may be stored as MSL 1 per JEDEC J-STD-033, meaning they have unlimited floor life in conditions of  $\leq 30$  °C/85% relative humidity (RH). Regardless of the storage condition, Cree LED recommends sealing any unsoldered LEDs in the original MBP.

### RoHS Compliance

The levels of RoHS restricted materials in this product are below the maximum concentration values (also referred to as the threshold limits) permitted for such substances, or are used in an exempted application, in accordance with EU Directive 2011/65/EC (RoHS2), as implemented January 2, 2013. RoHS Declarations for this product can be obtained from your Cree LED representative or from the [Product Ecology](#) section of the Cree LED website.

### REACH Compliance

REACH substances of very high concern (SVHCs) information is available for this product. Since the European Chemical Agency (ECHA) has published notice of their intent to frequently revise the SVHC listing for the foreseeable future, please contact a Cree LED representative to insure you get the most up-to-date REACH SVHC Declaration. REACH banned substance information (REACH Article 67) is also available upon request.

## NOTES - CONTINUED

---

### **UL® Recognized Component**

This product meets the requirements to be considered a UL Recognized Component with Level 4 enclosure consideration. The LED package or a portion thereof has been investigated as a fire and electrical enclosure per ANSI/UL 8750.

### **Vision Advisory**

WARNING: Do not look at an exposed lamp in operation. Eye injury can result. For more information about LEDs and eye safety, please refer to the [LED Eye Safety application note](#).

## MECHANICAL DIMENSIONS

Thermal vias, if present, are not shown on these drawings.

All dimensions are  $\pm 0.13$  mm unless otherwise indicated.

### XHP35.2 High Density

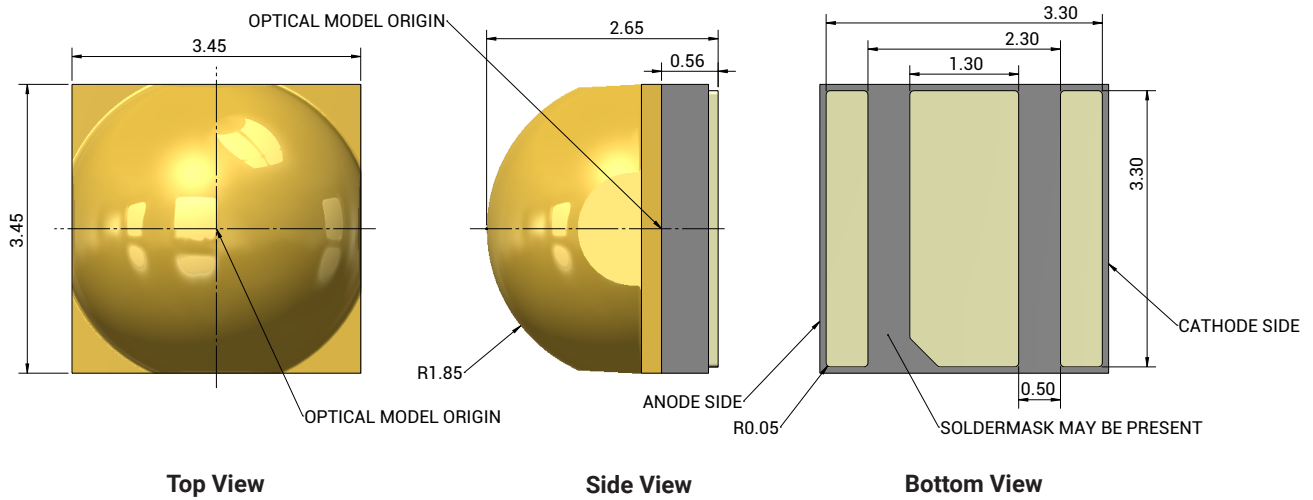

### XHP35.2 High Intensity

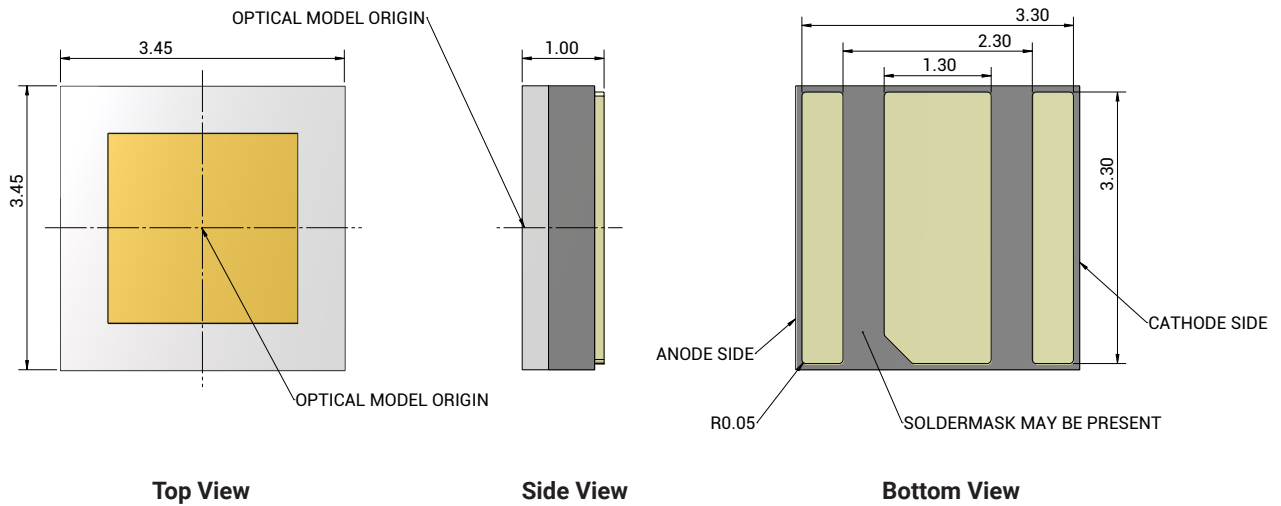



## MECHANICAL DIMENSIONS - CONTINUED

## XHP35.2 High Density and XHP35.2 High Intensity

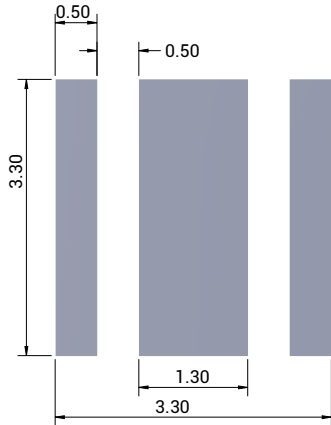

Recommended PCB Footprint

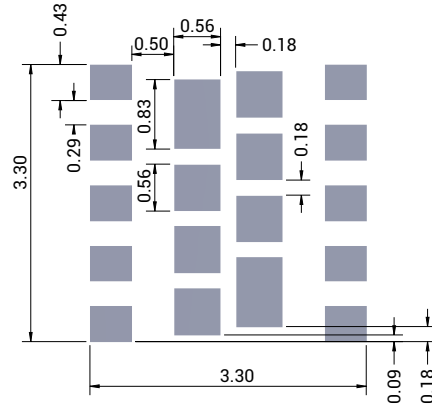

Recommended Stencil Openings\*

## Notes:

- Cree LED recommends using thermal pad kickouts to maximize component thermal performance.
- Cree LED recommends using white solder mask material to minimize system optical loss.
- \* This stencil has been tested and optimized for the avoidance of voiding when using ALPHA® LUMET® P30 Maxrel solder paste. For other solder pastes, a "window pane" design for the thermal pad stencil may result in a lower voiding percentage. Contact your local Cree LED Field Applications Engineer for consultation regarding your specific application.

**TAPE AND REEL**

All Cree LED carrier tapes conform to EIA-481D, Automated Component Handling Systems Standard.

Except as noted, all dimensions in mm [inches]

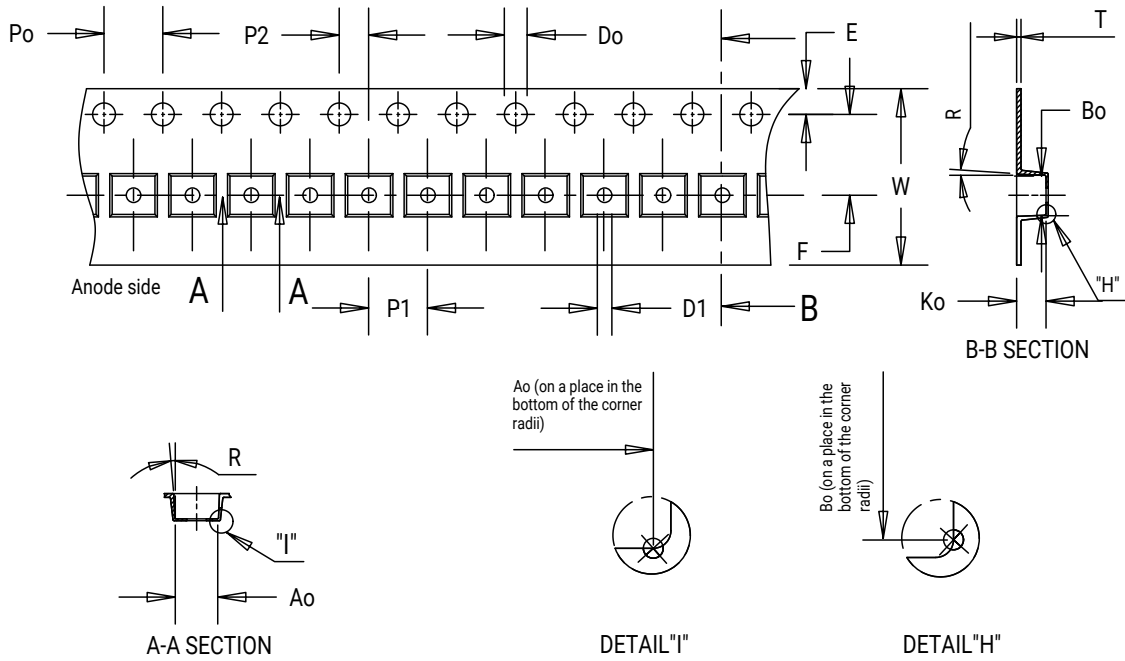

**XHP35.2 High Density**

XHP35B-0x-xxxx-xxxxxxxxxx

↑ XHP35.2 High Density

Item	Ao	Bo	Ko	Po	P1	P2	T	E	F	Do	D1	W	R
Dimension	3.60	3.60	3.00	4.00	8.00	2.00	0.30	1.75	5.50	1.50	1.50	12.00	3°

**XHP35.2 High Intensity**

XHP35B-Hx-xxxx-xxxxxxxxxx

↑ XHP35.2 High Intensity

Item	Ao	Bo	Ko	Po	P1	P2	T	E	F	Do	D1	W	R
Dimension	3.70	3.70	1.20	4.00	8.00	2.00	0.30	1.75	5.50	1.50	1.50	12.00	3°

**TAPE AND REEL - CONTINUED**

**XHP35.2 High Density**

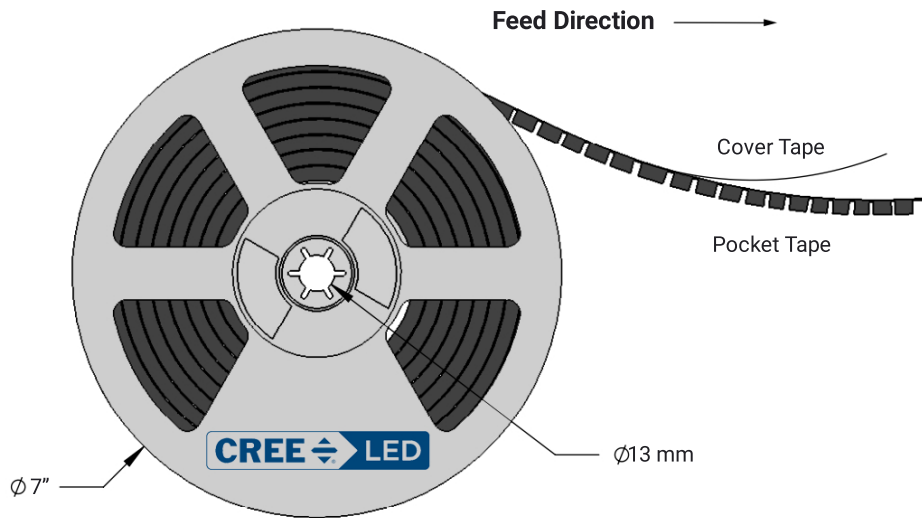
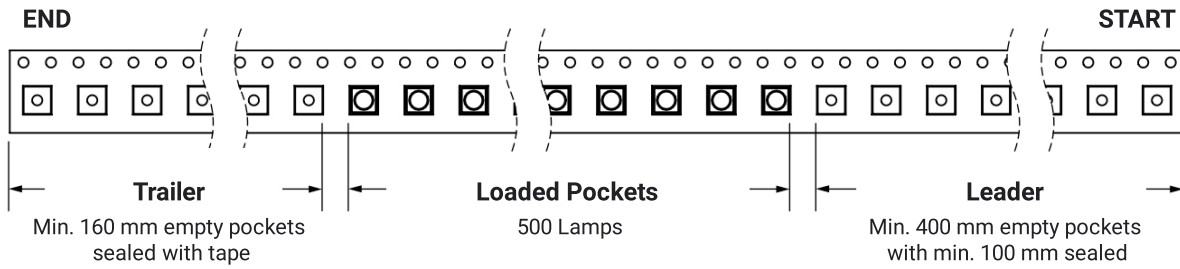

**TAPE AND REEL - CONTINUED**

**XHP35.2 High Intensity**

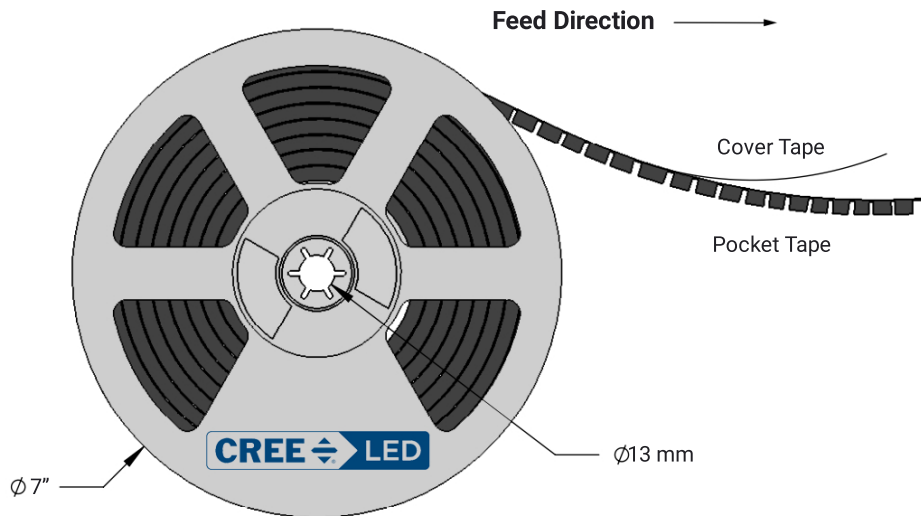
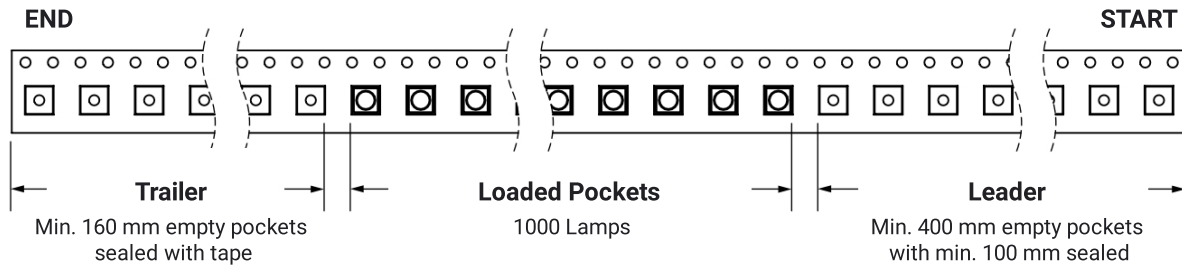

## PACKAGING

### Unpackaged Reel

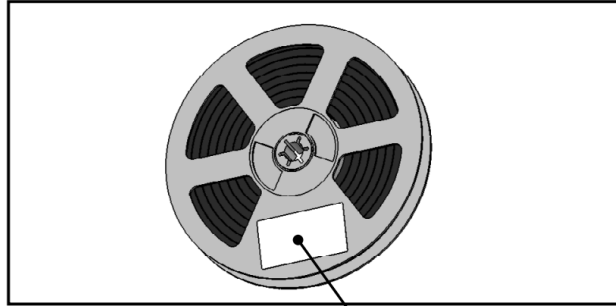

Label with Cree LED Bin Code, Quantity, Reel ID

### Packaged Reel

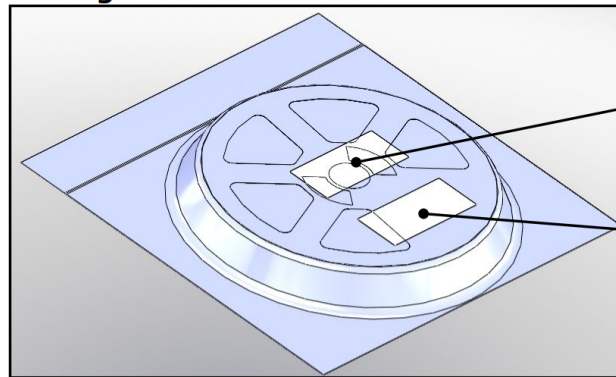

Label with Cree LED Order Code, Quantity, Reel ID, PO#

Label with Cree LED Bin Code, Quantity, Reel ID

### Boxed Reel

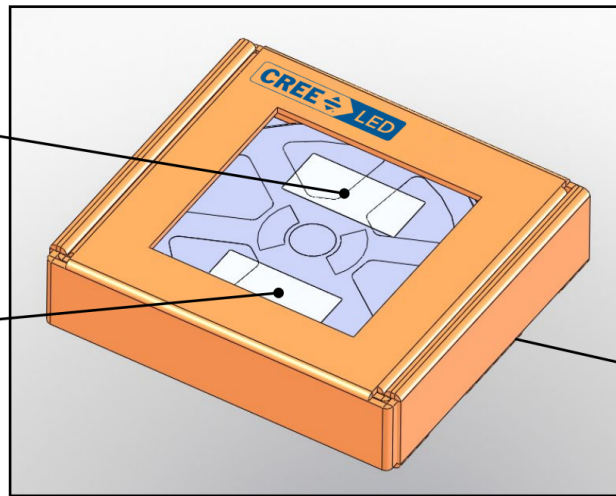

Label with Cree LED Order Code, Quantity, Reel ID, PO#

Label with Cree LED Bin Code, Quantity, Reel ID

Patent Label (on bottom of box)

**APPENDIX - ORDER CODES NOT FOR NEW DESIGNS**

The following order codes are active and valid order codes, but higher performance options are also available. Please see page 3–page 5 for order codes of XLamp XHP35.2 High Density LEDs that could serve as alternatives for the order codes set forth below.

**XHP35.2 High Density EasyWhite®, T<sub>J</sub> = 85 °C**

Nominal CCT	CRI		Minimum Luminous Flux @350 mA		2-Step		3-Step		5-Step	
	Min	Typ	Group	Flux (lm) @ 85 °C	Group	Order Code	Group	Order Code	Group	Order Code
5700 K	70		D4	550					57E	XHP35B-00-0000-0D0BD457E
	80		D2	510					57E	XHP35B-00-0000-0D0HD257E
	90		B4	410					57E	XHP35B-00-0000-0D0UB457E
5000 K	70		D4	550					50E	XHP35B-00-0000-0D0BD450E
	80		D2	510					50E	XHP35B-00-0000-0D0HD250E
	90		B4	410					50E	XHP35B-00-0000-0D0UB450E
4500 K	70		D4	550					45E	XHP35B-00-0000-0D0BD445E
	80		D2	510					45E	XHP35B-00-0000-0D0HD245E
	90		B4	410					45E	XHP35B-00-0000-0D0UB445E
4000 K	70		D4	550					40E	XHP35B-00-0000-0D0BD440E
			D2	510						XHP35B-00-0000-0D0BD240E
	80		D2	510			40G	XHP35B-00-0000-0D0HD240G	40E	XHP35B-00-0000-0D0HD240E
3500 K	70		D2	510					35E	XHP35B-00-0000-0D0BD235E
	80		C4	475			35G	XHP35B-00-0000-0D0HC435G	35E	XHP35B-00-0000-0D0HC435E
3000 K	80		C4	475			30G	XHP35B-00-0000-0D0HC430G	30E	XHP35B-00-0000-0D0HC430E
2700 K	80		C2	440			27G	XHP35B-00-0000-0D0HC227G	27E	XHP35B-00-0000-0D0HC227E

**Notes:**

- Cree LED maintains a tolerance of ±7% on flux and power measurements, ±0.005 on chromaticity (CCx, CCy) measurements and ±2 on CRI measurements. See the Measurements section (page 30).

**APPENDIX - ORDER CODES NOT FOR NEW DESIGNS - CONTINUED**

The following order codes are active and valid order codes, but higher performance options are also available. Please see page 6–page 8 for order codes of XLamp XHP35.2 High Density LEDs that could serve as alternatives for the order codes set forth below.

**XHP35.2 High Density ANSI, T<sub>j</sub> = 85 °C**

Nominal CCT	Chromaticity Regions	CRI		Minimum Luminous Flux @ 350 mA		Order Code
		Min	Typ	Group	Flux (lm) @ 85 °C	
7000 K	0A, 0B, 0C, 0D, 0R, 0S, 0T, 0U, 1A, 1B, 1C, 1D, 1R, 1S, 1T, 1U	90		B4	410	XHP35B-00-0000-0D0UB40DT
6500 K	1A, 1B, 1C, 1D	90		B4	410	XHP35B-00-0000-0D0UB40E1
6000 K	1A, 1B, 1C, 1D	90		B4	410	XHP35B-00-0000-0D0UB40DV
5700 K	2A, 2B, 2C, 2D	0	68	D4	550	XHP35B-00-0000-0D00D40E2
		70		D4	550	XHP35B-00-0000-0D0BD40E2
		80		D2	510	XHP35B-00-0000-0D0HD20E2
		90		B4	410	XHP35B-00-0000-0D0UB40E2
5000	3A, 3B, 3C, 3D	0	68	D4	550	XHP35B-00-0000-0D00D40E3
		70		D4	550	XHP35B-00-0000-0D0BD40E3
		80		D2	510	XHP35B-00-0000-0D0HD20E3
		90		B4	410	XHP35B-00-0000-0D0UB40E3
4500 K	4A, 4B, 4C, 4D	0	68	D4	550	XHP35B-00-0000-0D00D40E4
		70		D4	550	XHP35B-00-0000-0D0BD40E4
		80		D2	510	XHP35B-00-0000-0D0HD20E4
		90		B4	410	XHP35B-00-0000-0D0UB40E4
4000 K	5A, 5B, 5C, 5D	0	68	D4	550	XHP35B-00-0000-0D00D40E5
				D2	510	XHP35B-00-0000-0D00D20E5
		70		D4	550	XHP35B-00-0000-0D0BD40E5
			D2	510	XHP35B-00-0000-0D0BD20E5	
3500 K	6A, 6B, 6C, 6D	70		D2	510	XHP35B-00-0000-0D0BD20E6
		80		C4	475	XHP35B-00-0000-0D0HC40E6
3000 K	7A, 7B, 7C, 7D	80		C4	475	XHP35B-00-0000-0D0HC40E7
2700 K	8A, 8B, 8C, 8D	80		C2	440	XHP35B-00-0000-0D0HC20E8

**Notes:**

- Cree LED maintains a tolerance of ±7% on flux and power measurements, ±0.005 on chromaticity (CCx, CCy) measurements and ±2 on CRI measurements. See the Measurements section (page 30).

**APPENDIX - ORDER CODES NOT FOR NEW DESIGNS - CONTINUED**

The following order codes are active and valid order codes, but higher performance options are also available. Please see page 9–page 12 for order codes of XLamp XHP35.2 High Intensity LEDs that could serve as alternatives for the order codes set forth below.

**XHP35.2 High Intensity EasyWhite®, T<sub>j</sub> = 85 °C**

Nominal CCT	CRI		Minimum Luminous Flux @350 mA		2-Step		3-Step		5-Step	
	Min	Typ	Group	Flux (lm) @ 85 °C	Group	Order Code	Group	Order Code	Group	Order Code
5700 K	80		B4	410					57E	XHP35B-H0-0000-0D0HB457E
	90		B2	380					57E	XHP35B-H0-0000-0D0UB257E
			A4	355						XHP35B-H0-0000-0D0UA457E
5000 K	80		B4	410			50G	XHP35B-H0-0000-0D0HB450G	50E	XHP35B-H0-0000-0D0HB450E
	90		A4	355	50H	XHP35B-H0-0000-0D0UA450H	50G	XHP35B-H0-0000-0D0UA450G	50E	XHP35B-H0-0000-0D0UA450E
4500 K	80		B4	410			45G	XHP35B-H0-0000-0D0HB445G	45E	XHP35B-H0-0000-0D0HB445E
	90		A4	355	45H	XHP35B-H0-0000-0D0UA445H	45G	XHP35B-H0-0000-0D0HB445G	45E	XHP35B-H0-0000-0D0UA445E
4000 K	80		B4	410			40G	XHP35B-H0-0000-0D0HB440G	40E	XHP35B-H0-0000-0D0HB440E
3500 K	90		A2	330	35H	XHP35B-H0-0000-0D0UA235H	35G	XHP35B-H0-0000-0D0UA235G	35E	XHP35B-H0-0000-0D0UA235E
3000 K	80		B2	380			30G	XHP35B-H0-0000-0D0HB230G	30E	XHP35B-H0-0000-0D0HB230E
	90		A2	330	30H	XHP35B-H0-0000-0D0UA230H	30G	XHP35B-H0-0000-0D0UA230G	30E	XHP35B-H0-0000-0D0UA230E

**Notes:**

- Cree LED maintains a tolerance of ±7% on flux and power measurements, ±0.005 on chromaticity (CCx, CCy) measurements and ±2 on CRI measurements. See the Measurements section (page 30).



## APPENDIX - ORDER CODES NOT FOR NEW DESIGNS - CONTINUED

The following order codes are active and valid order codes, but higher performance options are also available. Please see page 13 –page 15 for order codes of XLamp XHP35.2 High Intensity LEDs that could serve as alternatives for the order codes set forth below.

### XHP35.2 High Intensity ANSI, $T_j = 85\text{ }^\circ\text{C}$

Nominal CCT	Chromaticity Regions	CRI		Minimum Luminous Flux @ 350 mA		Order Code
		Min	Typ	Group	Flux (lm) @ 85 °C	
6500 K	1A, 1B, 1C, 1D	80		B4	410	XHP35B-H0-0000-0D0HB40E1
		90		B2	380	XHP35B-H0-0000-0D0UB20E1
				A4	355	XHP35B-H0-0000-0D0UA40E1
5700 K	2A, 2B, 2C, 2D	80		B4	410	XHP35B-H0-0000-0D0HB40E2
		90		B2	380	XHP35B-H0-0000-0D0UB20E2
				A4	355	XHP35B-H0-0000-0D0UA40E2
5000 K	3A, 3B, 3C, 3D	80		B4	410	XHP35B-H0-0000-0D0HB40E3
		90		A4	355	XHP35B-H0-0000-0D0UA40E3
4500 K	4A, 4B, 4C, 4D	80		B4	410	XHP35B-H0-0000-0D0HB40E4
		90		A4	355	XHP35B-H0-0000-0D0UA40E4
4000 K	5A, 5B, 5C, 5D	80		B4	410	XHP35B-H0-0000-0D0HB40E5
3500 K	6A, 6B, 6C, 6D	90		A2	330	XHP35B-H0-0000-0D0UA20E6
3000 K	7A, 7B, 7C, 7D	80		B2	380	XHP35B-H0-0000-0D0HB20E7
		90		A2	330	XHP35B-H0-0000-0D0UA20E7

#### Notes:

- Cree LED maintains a tolerance of  $\pm 7\%$  on flux and power measurements,  $\pm 0.005$  on chromaticity (CCx, CCy) measurements and  $\pm 2$  on CRI measurements. See the Measurements section (page 30).