

## SUMMARY

### # Wires

Low voltage 6



*Image is for illustrative purpose only*

Series 1B  
Termination type Male crimp  
IP rating 50  
AWG wire size 26.00 - 22.00  
Cable Ø 3.10 - 4.20 mm  
Status active  
Matching parts [EGG.1B.306.CLL](#)

### Download

[Request a quote](#)  
[Eplan](#)  
[Catalog](#)

## TECHNICAL DETAILS

### Mechanics

Shell Style/Model FP\*: Elbow (90°) plug with cable collet for bend relief  
Keying 1 key (alpha=0, plug: male contacts, receptacle: female contacts)  
Housing Material Brass (chrome plated [SAE AMS 2460]) shell and collet nut, nickel plated [SAE AMS QQ N 290] brass latch sleeve and mid pieces  
Variant Z : Nut for fitting a bend relief  
Weight 24.27 g

### Performance

Configuration 1B.306 : 6 Low Voltage  
Insulator Y: PEEK for crimp contacts  
Rated Current 7 Amps

### Specifications

Contact Type: Crimp  
Contact Retention: 22 N  
Contact Dia.: 0.7 mm (0.028in)  
Bucket Dia.: 0.8 mm (0.031in)  
Min. Conductor: 0.14 mm<sup>2</sup> (AWG 26)  
Max. Conductor: 0.34 mm<sup>2</sup> (AWG 22)

*LEMO products and services are provided "as is". LEMO makes no warranties or representations with regard to LEMO product & services or use of them, express, implied or statutory, including for accuracy, completeness, or security. The user is fully responsible for his products and applications using LEMO components.*

R (max): 6.1 mOhm  
 Vtest (contact-shell): 1450 V (AC), 2050 V (DC)  
 Vtest (contact-contact): 1350 V (AC), 1910 V (DC)

## Others

Endurance (Shell): 5000  
 Temp (min / max): -55° C / +250° C  
 Humidity (max): <=95% [at 60 deg C / 140 F]  
 Vibration: 15 g [10 Hz - 2000 Hz]  
 Shock Resistance: 100 g [ 6 ms]  
 Climatical Category: 50/175/21  
 Shielding (min): 75 dB (10 MHz)  
 Shielding (min): 40 dB (1 GHz)  
 Salt Spray Corrosion: >1000 hr

## DRAWINGS

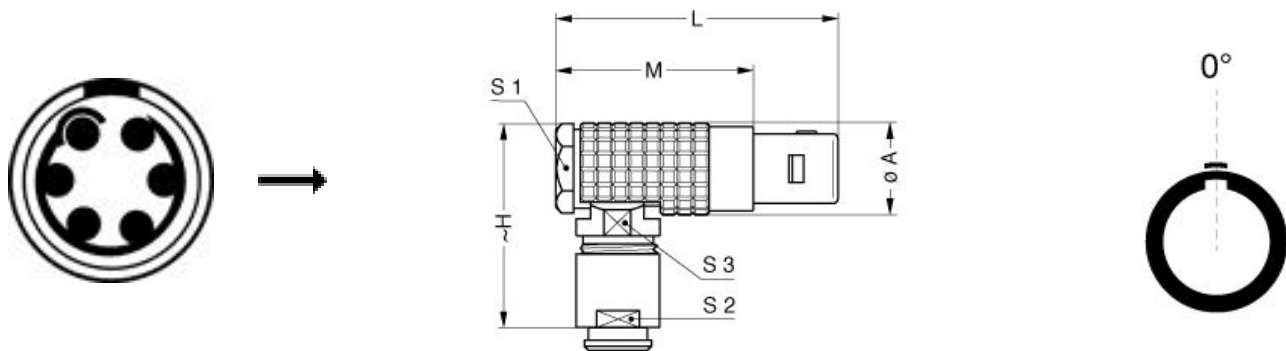

## Dimensions

	A	H	L	M	S1	S2	S3
mm.	12	27.7	36	25	11	9	10
in.	0,47	1,09	1,42	0,98	0,43	0,35	0,39







## RECOMMENDED BY LEMO

LEMO products and services are provided "as is". LEMO makes no warranties or representations with regard to LEMO product & services or use of them, express, implied or statutory, including for accuracy, completeness, or security. The user is fully responsible for his products and applications using LEMO components.

## Tools

Crimp Tool:	<a href="#">DPC.91.701.V</a>
Crimp settings:	AWG/Selector = 22-24-26/6-5-5
Positionner:	<a href="#">DCE.91.071.BVC</a>
Extractor:	<a href="#">DCC.07.04B.LAG</a>
Replacement contact:	FGG.1B.555.ZZC
Spanner wrench:	<a href="#">DCD.1B.ZZZ.PA090</a>

## Cables

CMN.06.T26.037QGZE	TPR (medical)	Grey	
CMN.06.T28.031PGCE	PVC	GREY	
CMN.06.T28.031PGZE		Grey	
CMN.06.T28.031PNCE	PVC	Black	
CMN.06.T28.031PNZE			
CMN.06.T28.042QBCE	TPR (medical)		
60260	PTFE	White	

LEMO products and services are provided "as is". LEMO makes no warranties or representations with regard to LEMO product & services or use of them, express, implied or statutory, including for accuracy, completeness, or security. The user is fully responsible for his products and applications using LEMO components.