

SUMMARY

Wires

Low voltage 8



Image is for illustrative purpose only

Series 2M
Termination type Female print PCB
IP rating 68 when mated
AWG wire size 30.00 - 22.00
Cable Ø 0.00 - 0.00 mm
Status active
Matching parts [FMN.2M.308.XLC](#)

Download

[Request a quote](#)
[PCB Eagle Pattern](#)
[PCB Altium Pattern](#)
[PCB KiCad Pattern](#)
[Catalog](#)

TECHNICAL DETAILS

Mechanics

Shell Style/Model HE*: Fixed receptacle, nut fixing for printed circuit, watertight
Keying 3 keys (beta=165, gamma=30, plug: male contacts, receptacle: female contacts)
Housing Material Aluminium (nickel plated [SAE AMS QQ N 290], anthracite color) shell and nut, other pieces bronze/brass
Variant P : Watertight unmated
Weight 11.29 g

Performance

Configuration 2M.308 : 8 Low Voltage
Insulator L: PEEK
Rated Current 10 Amps

Specifications

Contact Type: Print (straight)
Contact Dia.: 0.9 mm (0.035in)
R (max): 4.8 mOhm
Test voltage (kV rms) Contact-contact: 1.95
Test voltage (kV rms) Contact-shell: 1.1

LEMO products and services are provided "as is". LEMO makes no warranties or representations with regard to LEMO product & services or use of them, express, implied or statutory, including for accuracy, completeness, or security. The user is fully responsible for his products and applications using LEMO components.

Others

Endurance (Shell): 3000 mating cycles

Temp (min / max): -20°C / +80°C

Humidity (max): 21 days at 95%

Gunfire vibration: 25 Hz - 2000 Hz, 3 axis (Apache helicopter)

Vibration-Sine: 30 g, 3 axes, 12 hr [10 Hz - 2000 Hz]

Vibration-Random: 37.8 g rms - 3 axes, 4 hr amb [50 Hz - 2000 Hz]

Shock Resistance: 300 g [3 ms]

Lighting strike EIA 364-75: 10K amps - 6 times

EMI Shielding EIA 364-66A: >= 80 dB (1 GHz), >=70 dB (3 GHz), >= 58 dB (6 GHz), >= 40 dB (10 GHz)

Salt Spray Corrosion: max. 48 hr

DRAWINGS

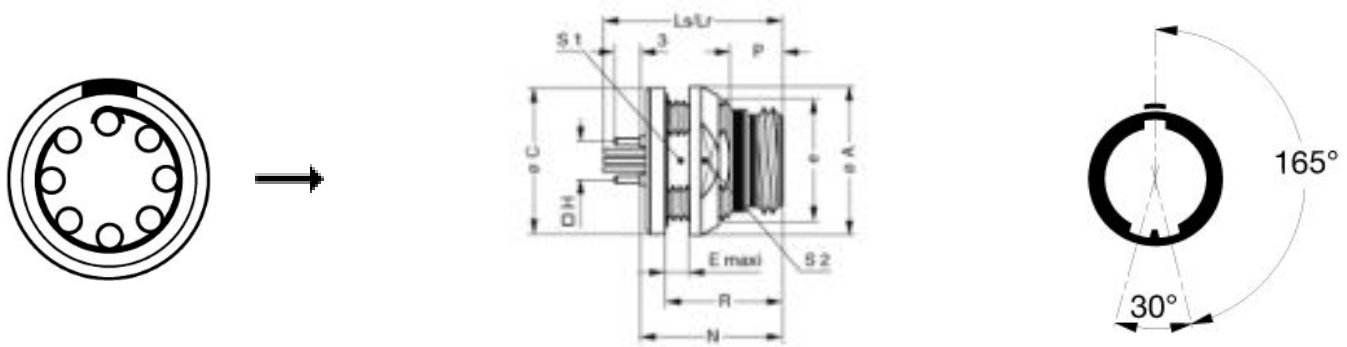

Dimensions

	A	C	E	H	Lr	Ls	N	P	R	S1	S2	e
mm.	21	20.8	5	8.89	21	20.8	16.8	5.3	13.8	15.5	18	M17x1.00
in.	0,83	0,82	0,20	0,35	0,83	0,82	0,66	0,21	0,54	0,61	0,71	

RECOMMENDED BY LEMO

Tools

Spanner wrench: [Socket for torque wrench DCM.65.180.AZ](#)

LEMO products and services are provided "as is". LEMO makes no warranties or representations with regard to LEMO product & services or use of them, express, implied or statutory, including for accuracy, completeness, or security. The user is fully responsible for his products and applications using LEMO components.

LEMO products and services are provided "as is". LEMO makes no warranties or representations with regard to LEMO product & services or use of them, express, implied or statutory, including for accuracy, completeness, or security. The user is fully responsible for his products and applications using LEMO components.