

## PLED120W Series Flicker-Free High Performance LED Drivers

select **SYNC**  
classic

### Electrical Specifications

Input Voltage Range:	100-277 Vac Nom. (90-305 V Min/Max)
Input Over-Voltage:	Can endure 320Vac for 48 Hrs, 350Vac for 2 Hrs
Frequency:	50/60 Hz Nom. (47-63 Hz Min/Max)
Power Factor:	>0.90 @ > 70% load, 120-277V
Inrush Current:	60.0 Amps max @ 277 Vac, cold start, full load
Input Current:	0.60 Amps max @ 230 Vac, 1.20 A max @ 120 Vac
Maximum Power:	120W
Current Accuracy:	± 3%
Load Regulation:	± 4%
THD:	≤ 20% @ > 70% load, 120-277V
Ripple & Noise: (Vpk-pk)	5% Vo max @ 20 MHz BW, Full load output in parallel with 0.1 µF ceramic & 10 µF Electrolytic
Ripple: (Ipk-pk)	5% Io max @ 20 MHz BW, Full load output in parallel with 0.1 µF ceramic & 10 µF Electrolytic. 120 Hz component (Flicker Free)
Start-up Time:	150mS typical @ Full Load, 120Vac/60Hz (1000mS max)
Leakage Current:	0.68 mA max @ 120Vac, 0.75 mA max @ 277Vac
Hold Up Time:	30mS typical @ Full Load, 277Vac

### Protections

Over-voltage	Output
Over-current	Output
Short Circuit	Auto Recovery

### Environmental Specifications

Max Case Life Temp: (5 year warranty)	76°C
Maximum Case Temp (UL):	90°C
Minimum Starting Temp:	-30°C
UL Type TL Rating:	Non-Class 2: 90/82°C
Storage Temperature:	-40°C to +85°C
Humidity:	5% to 95%
Cooling:	Convection
Vibration Frequency:	5 to 55 Hz/2g, 30 minutes
Impact Resistance:	1g/s
MTBF:	280,000 Hours at full load and 40°C ambient conditions per MIL-217F Notice 2
EMC:	FCC 47CFR Part 15 Class B compliant
Weight:	24.4 oz (690 grams)

#### Dimming Option:

**“-D”** 0-10V & Resistance dimmable models include an extra two wires +Purple/-Pink on the output side. “-D” Compatible with most quality 0-10V wall dimmers. See page 3.

**“-D3”** 3-wire dimmable model dims 100% to 10%. Three extra wires included on the output side: Yellow/Purple/Pink. This model is suitable for potentiometer dimming. See page 3.

#### Note:

LED drivers are designed and intended to operate LED loads only. Non-LED loading may be outside the specified design limits of our LED drivers, and therefore cannot be covered by any warranty. If you desire to use our LED drivers to operate non-LED loads please contact us to discuss compatibility.



### Constant Current Models

Model	Output Current (mA ±5%)	Output Voltage Range (Vdc)	Max Output Power (W)	Typical Efficiency
PLED120W-343-C0350-XX	350	114-343	120	92%
PLED120W-266-C0450-XX	450	89-266	120	92%
PLED120W-171-C0700-XX	700	57-171	120	91%
PLED120W-114-C1050-XX	1050	38-114	120	91%
PLED120W-086-C1400-XX	1400	29-86	120	91%
PLED120W-068-C1750-XX	1750	23-68	120	91%
PLED120W-057-C2100-XX	2100	19-57	120	90%
PLED120W-049-C2450-XX	2450	17-49	120	90%
PLED120W-043-C2800-XX	2800	15-43	120	90%
PLED120W-038-C3150-XX	3150	13-38	120	90%
PLED120W-034-C3500-XX	3500	12-34	120	89%
PLED120W-028-C4200-XX	4200	10-28	120	89%
PLED120W-024-C5000-XX	5000	8-24	120	89%

-XX indicates dimming options are available. See options at left. Blank = fixed current output

### Constant Voltage Models

Model	Output Voltage (Vdc ±5%)	Output Current Range (mA)	Max Output Power (W)	Typical Efficiency
PLED120W-024	24	1250-5000	120	89%
PLED120W-028	28	1050-4200	120	89%
PLED120W-034	34	875-3500	120	89%
PLED120W-038	38	788-3150	120	90%
PLED120W-043	43	700-2800	120	90%
PLED120W-049	49	613-2450	120	90%
PLED120W-057	57	525-2100	120	90%
PLED120W-068	68	438-1750	120	91%
PLED120W-086	86	350-1400	120	91%
PLED120W-114	114	263-1050	120	91%
PLED120W-171	171	175-700	120	91%
PLED120W-266	266	113-450	120	92%
PLED120W-343	343	88-350	120	92%

• Indicates S.A.M.

- Total Power: 120 Watts
- Input Voltage: 100-277 Vac Nom.
- Constant Current & Constant Voltage with Isolation
- UL Dry & Damp Location Rated
- IP66 & NEMA6
- UL Type HL Rated for Hazardous Locations
- UL Sign Components Manual (S.A.M. Models)
- Black Magic Thermal Advantage™ Aluminum Housing

**Dimensions**

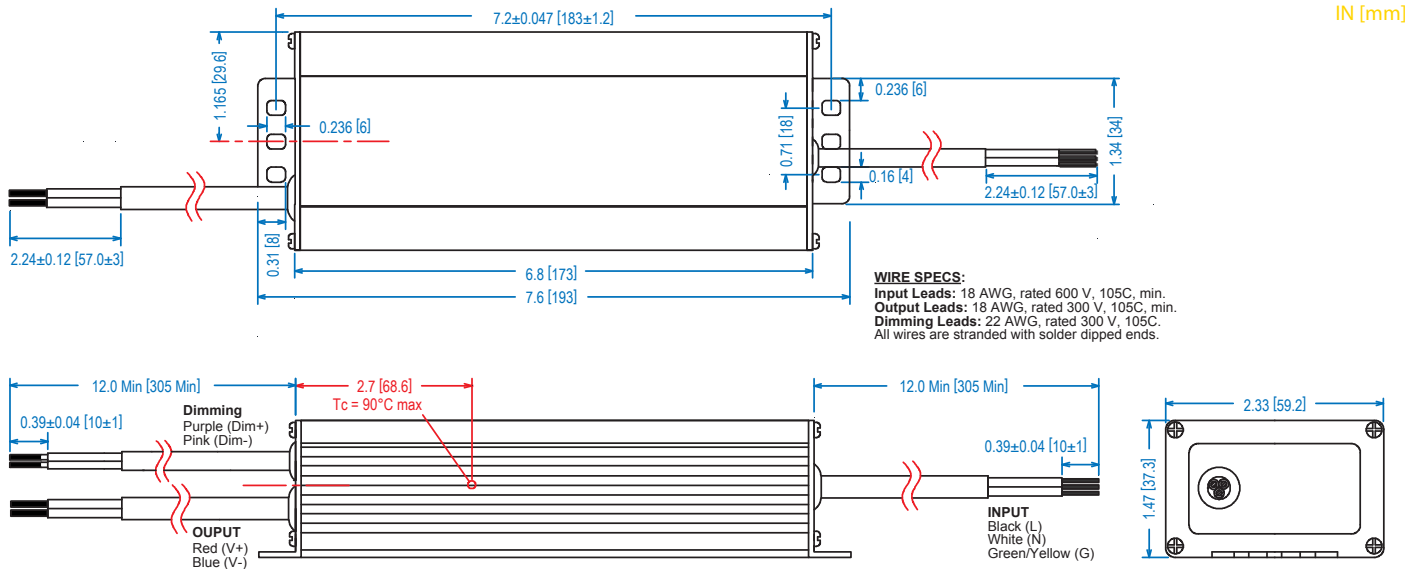

**Power Characteristics**

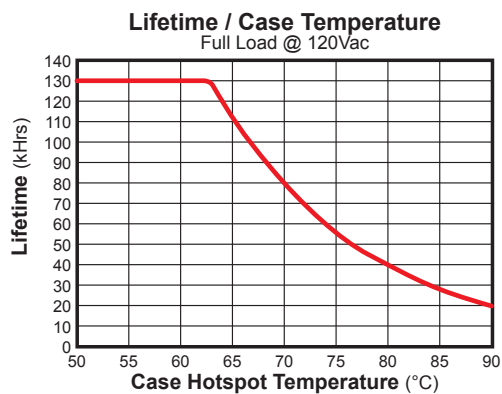
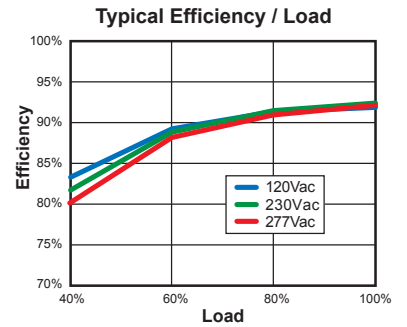
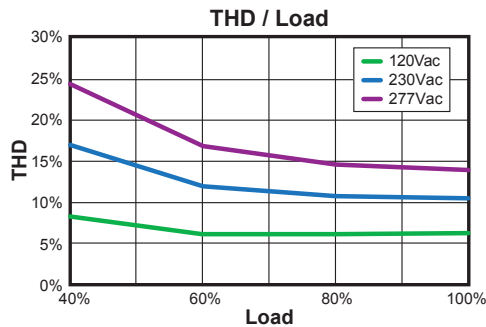
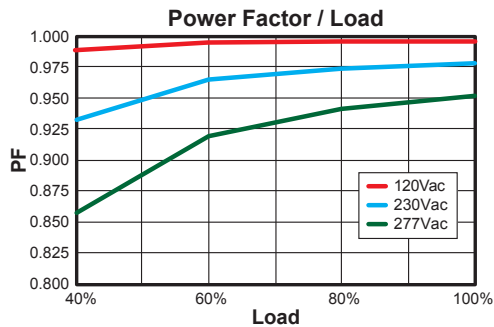

Safety Cert.	Standard
UL/CUL	UL8750 & CAN/CSA-22.2 No. 250.13-12, UL1012/CSA-C22.2 No.107.1
CE	EN 61347-1, EN61347-2-13
EMC Standard	Notes
FCC, 47CFR Part 15	Class B
EN 55015	Limits and methods of measurement of radio disturbance characteristics of electrical lighting and similar equipment.
EN 61000-3-2	Part 3-2: Limits for harmonic current emissions Class C, >80% Rated Power
EN 61000-3-3	Part 3-3: Limitation of voltage changes, voltage fluctuations and flicker.
EN 61000-4-5	Part 4-5: Surge Immunity test, 2 kV L-N, 4 kV L-G & N-G

**UL Conditions of Acceptability**

See website for additional information

**Note:** The area under the life-temperature curve represents where the driver has highly reliable operation within specification. Driver performance may drift out of published specifications as the hours of operation exceed the curve at a given temperature. Higher operating temperatures increase the chances of a failure to function. Other electrical, mechanical and environmental factors affect driver lifetime but are not represented in this calculation.

### "-D" Option: 0-10VDC and Resistance Dimming

Parameters	Minimum	Typical	Maximum
10V Output, Yellow Wire	9.2V	10.0V	10.8V
Source Current out of Aux Yellow Wire	—	—	10mA
Absolute Voltage Range on 0-10V (+) Purple Wire	-2.0V	—	+15V
Source Current out of 0-10V Purple Wire	0mA	—	2mA

#### Typical Dimming Circuit

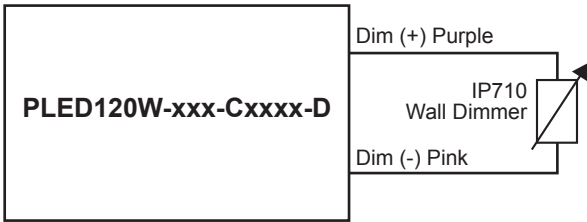

(Dimmer must be current-sink type control)

#### 3-Wire Dimming Typical Circuit

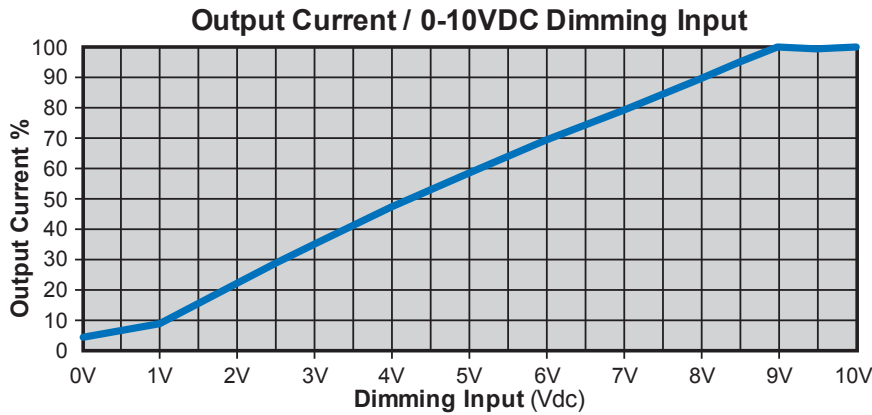
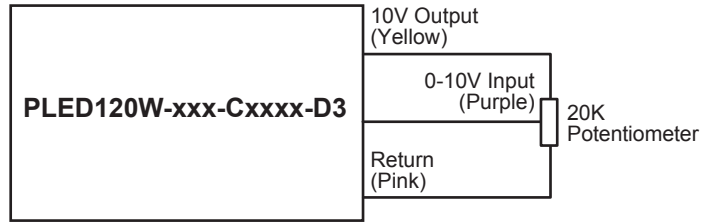

#### Notes:

- 0-10V dimmable version comes with an extra two wires +Purple/-Pink on the output side.
- Compatible with most 0-10V Wall Slide dimmers and direct 0-10V analog signal. Recommended dimmer is Leviton IP710 or equivalent
- 0-10V dimmable version is not intended to dim to zero (off). Will be out <10% @ Vdim <1.0V
- 0-10V dimmable version output will be 100% with Purple/Pink open and minimum with Purple/Pink Shorted.
- For units manufactured after Date of January 1<sup>st</sup> 2022, the Dim(-) wire will be gray, not pink.