

## RF Power Pot Capacitors with Mounting Tags, Class 1 Ceramic



### FEATURES

- High reliability
- Multiple terminals
- Wide range of capacitance values

### APPLICATIONS

- Induction and dielectric heating
- Antenna units
- Filter, bypass, and coupling circuits

QUICK REFERENCE DATA											
DESCRIPTION	VALUE										
Ceramic Class	1										
Ceramic Dielectric	R7, R16, R42, R85			R7, R42, R85				R7, R16, R42, R85, R230			
Type	TA 045090, TB 045090, TD 045090, TE 045090			TA 045120, TB 045120, TD 045120, TE 045120				TA 045150, TB 045150, TD 045150, TE 045150			
Voltage (V <sub>p</sub> )	9000	10 000	10 000	11 000	12 000	13 000	11 000	12 000	13 000	14 000	
Min. Capacitance (pF)	2500	60	1600	160	80	50	5000	2000	400	60	
Max. Capacitance (pF)	2500	1600	1600	500	100	1000	5000	2000	1600	4000	
Mounting	Screw terminal										

### MATERIAL

Capacitor elements made from class 1 ceramic dielectric with noble metal electrodes.

Connection terminals:  
made from copper / brass, silver plated.

### FINISH

Capacitor body completely protective lacquered.  
The contoured insulating rim is additionally glazed.

### MARKING

Type designator, capacitance value and tolerance, rated peak voltage, ceramic material code, production date code, manufacturer logo.

### CAPACITANCE RANGE

50 pF to 5.0 nF

### CAPACITANCE TOLERANCE

± 20 %; ± 10 %; ± 5 %

### DIELECTRIC STRENGTH TEST

200 % of rated AC voltage (50 Hz, 5 minutes)

### INSULATION RESISTANCE

Min. 10 000 MΩ (at 25 °C)

### CERAMIC DIELECTRICS

- R7 (TCC + 100 ppm/K)
- R16 (TCC + 100 ppm/K)
- R42 (TCC - 250 ppm/K)
- R85 (TCC - 750 ppm/K)
- R230 (TCC - 750 ppm/K)

### RATED VOLTAGE

- 9.0 kV<sub>p</sub>
- 10.0 kV<sub>p</sub>
- 11.0 kV<sub>p</sub>
- 12.0 kV<sub>p</sub>
- 13.0 kV<sub>p</sub>
- 14.0 kV<sub>p</sub>

### DISSIPATION FACTOR

- R7: max. 0.07 %
- R16: max. 0.04 %
- R42, R85, R230: max. 0.05 %

Measuring frequencies:

1 MHz (< 1 nF); 300 kHz or 100 kHz (≥ 1 nF)

### OPERATING TEMPERATURE RANGE

-55 °C to +100 °C



SAP PART NUMBER AND ELECTRICAL DATA						
PART NUMBER	CERAMIC	CAP. VALUES (pF)	RATED VOLTAGE (kV <sub>p</sub> )	RATED POWER <sup>(1)</sup> (kvar)	RATED CURRENT (A <sub>rms</sub> )	
<b>TYPE T. 045090</b>						
T#045090BH600##BF1	R7	60	10	22	12	
T#045090BH800##BF1		80				
T#045090BH101##BF1		100				
T#045090BH161##BF1		160				
T#045090BH201##BG1	R16	200				
T#045090BH251##BG1		250				
T#045090BH301##BG1		300				
T#045090BH401##BH1	R42	400				
T#045090BH501##BH1		500				
T#045090BH601##BH1		600				
T#045090BH801##BJ1	R85	800		9.0		28
T#045090BH102##BJ1		1000				
T#045090BH162##BJ1		1600				
T#045090WC252##BJ1		2500				
<b>TYPE T. 045120</b>						
T#045120WH500##BF1	R7	50	13	28	10	
T#045120WH600##BF1		60	12			
T#045120WF800##BF1		80				
T#045120WF101##BF1		100				
T#045120WE161##BF1		160	11			
T#045120WH251##BH1	R42	250	13			
T#045120WH301##BH1		300				
T#045120WH401##BH1		400				
T#045120WE501##BH1		500		11		
T#045120WH601##BJ1	R85	600	13	35		
T#045120WH801##BJ1		800				
T#045120WH102##BJ1		1000				
T#045120BH162##BJ1		1600			10	
<b>TYPE T. 045150</b>						
T#045150WJ600##BF1	R7	60	14	35	12	
T#045150WJ800##BF1		80				
T#045150WJ101##BF1		100				
T#045150WJ201##BG1	R16	200				
T#045150WJ301##BH1	R42	300				13
T#045150WH401##BH1		400				
T#045150WH501##BH1		500				
T#045150WH601##BH1	R85	600	13	42		
T#045150WJ801##BJ1		800				
T#045150WH102##BJ1		1000				
T#045150WH162##BJ1		1600				
T#045150WF202##BJ1		2000				12
T#045150WJ302##BK1	R230	3000	14			
T#045150WJ402##BK1		4000				
T#045150WE502##BK1		5000		11		

**Notes**

- # 2<sup>nd</sup> digit: code letter of the terminal version A, B, D, E
- ## 14<sup>th</sup> to 15<sup>th</sup> digit: capacitance tolerance code  $\pm 20\% = 38$ ,  $\pm 10\% = 36$ ,  $\pm 5\% = 33$
- (<sup>1</sup>) The surface temperature during operation must not exceed +100 °C

**DIMENSIONS** in millimeters (inches)

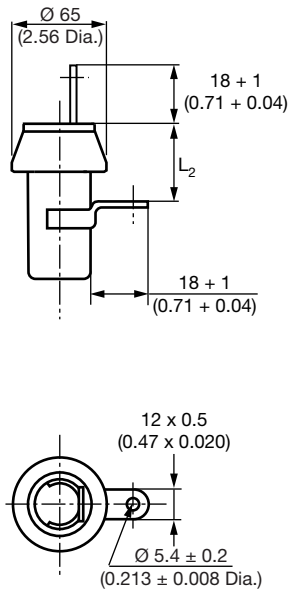
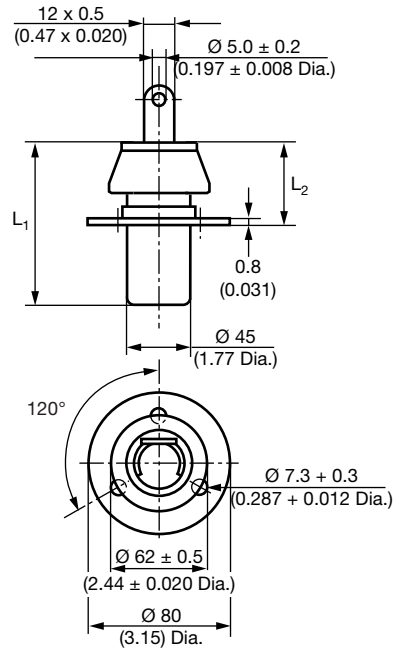
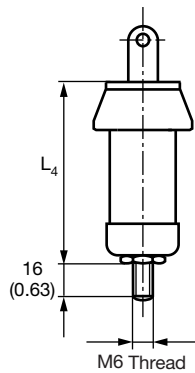
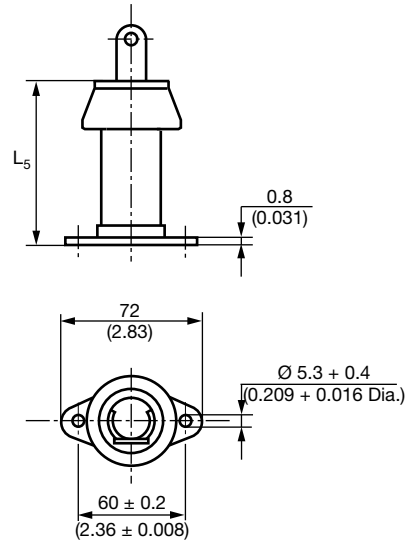
**TA**

**TB**

**TD**

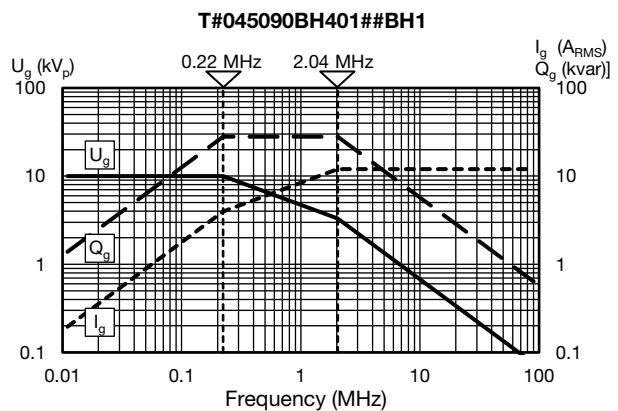
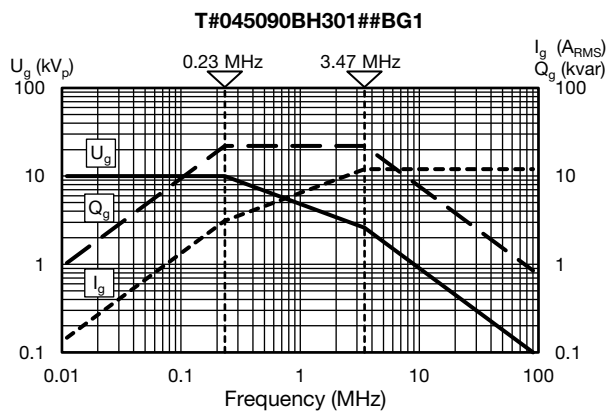
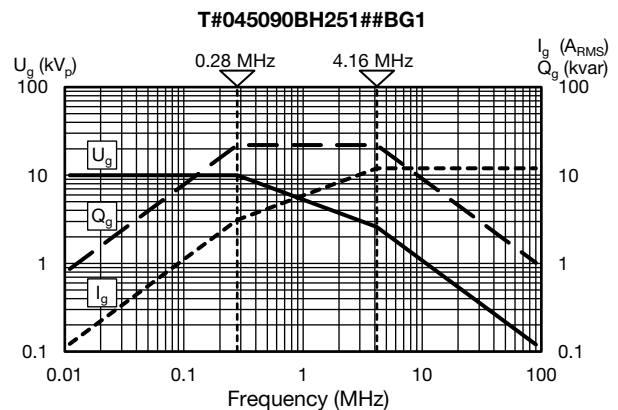
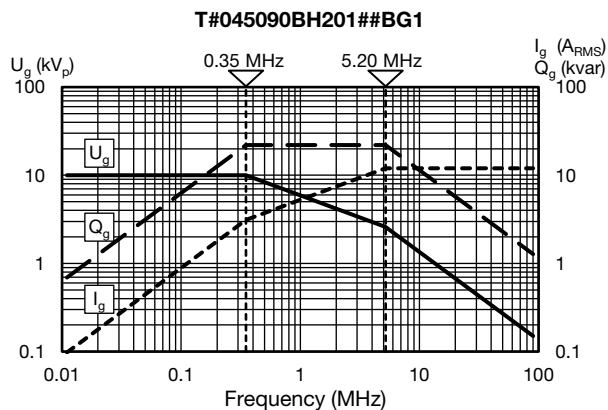
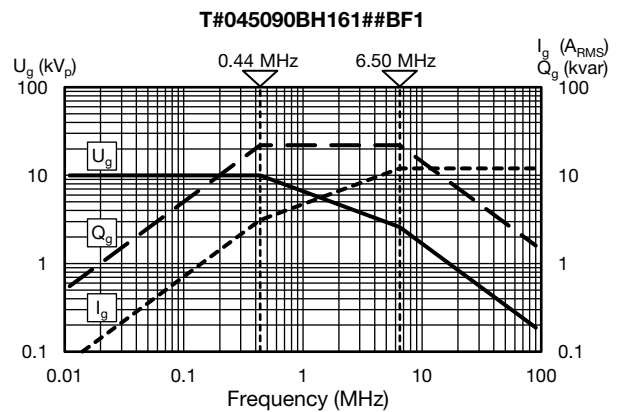
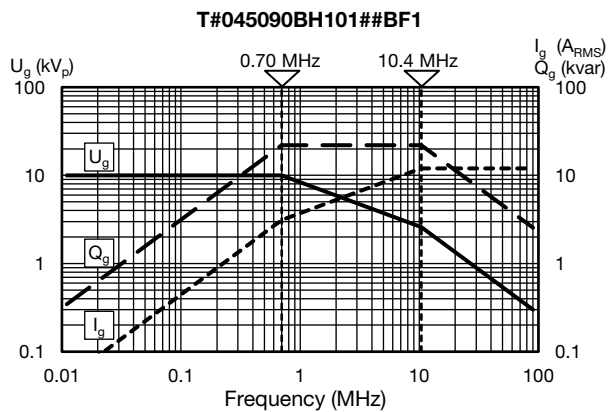
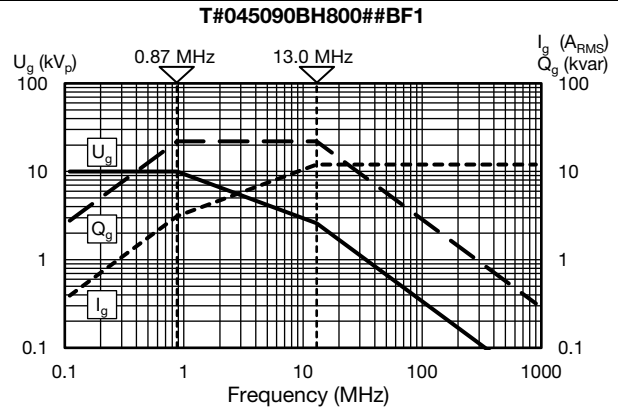
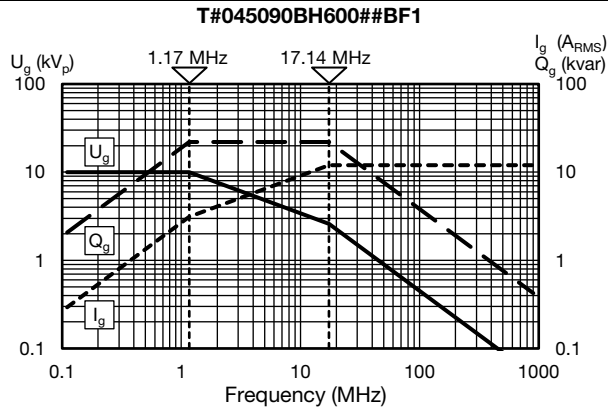
**TE**

TYPE	T. 045090	T. 045120	T. 045150
Length $L_1$	90 (3.54)	120 (4.72)	150 (5.91)
Length $L_2$	45 ± 2 (1.77 ± 0.08)	60 ± 2 (2.36 ± 0.08)	75 ± 2 (2.95 ± 0.08)
Length $L_4$	97 (3.82)	127 (5.00)	157 (6.18)
Length $L_5$	92 ± 2 (3.62 ± 0.08)	122 ± 2 (4.80 ± 0.08)	152 ± 2 (5.98 ± 0.08)

**DERATING DIAGRAMS**





DERATING DIAGRAMS

T#045090BH501##BH1

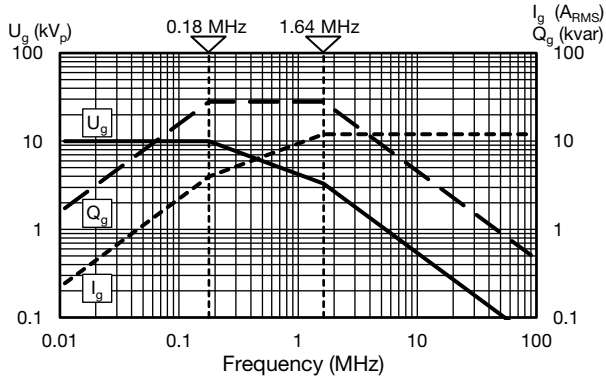

T#045090BH601##BH1

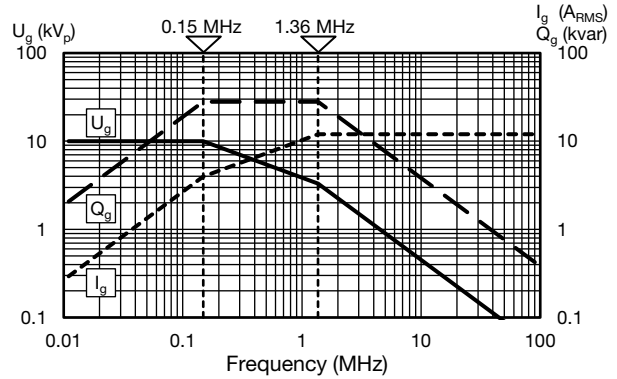

T#045090BH801##BJ1

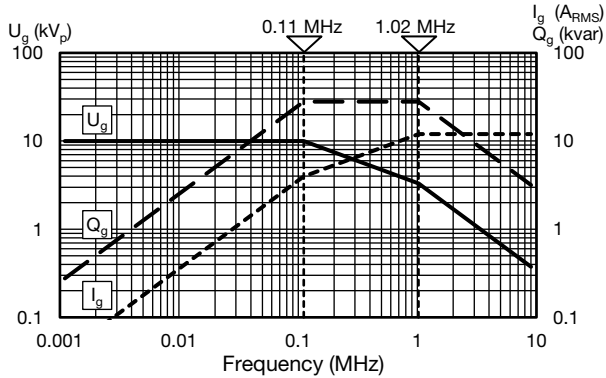

T#045090BH102##BJ1

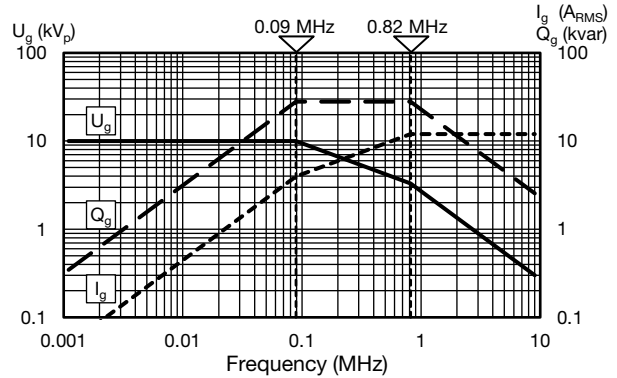

T#045090BH162##BJ1

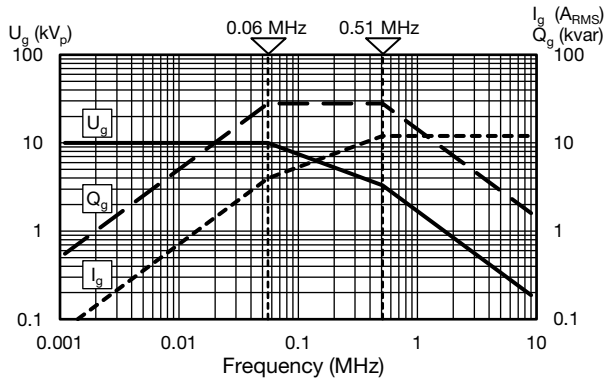

T#045090WC252##BJ1

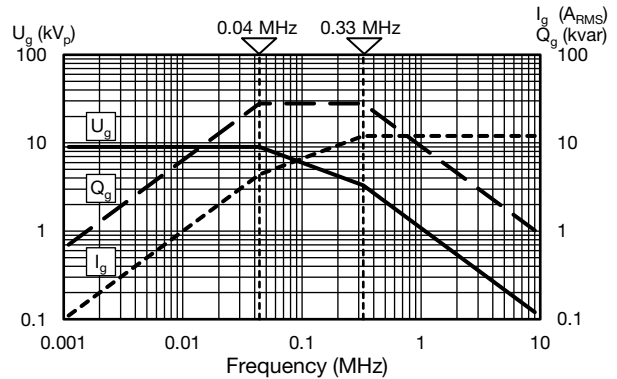

T#045120WH500##BF1

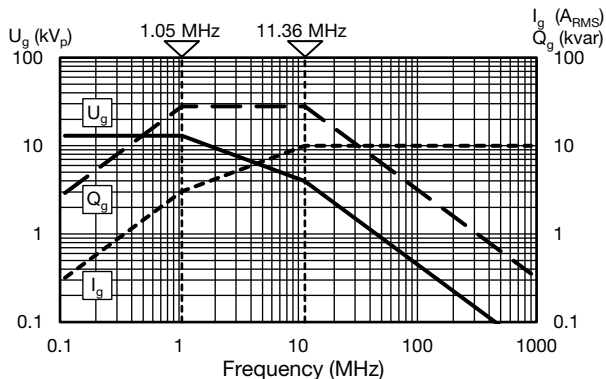

T#045120WH600##BF1

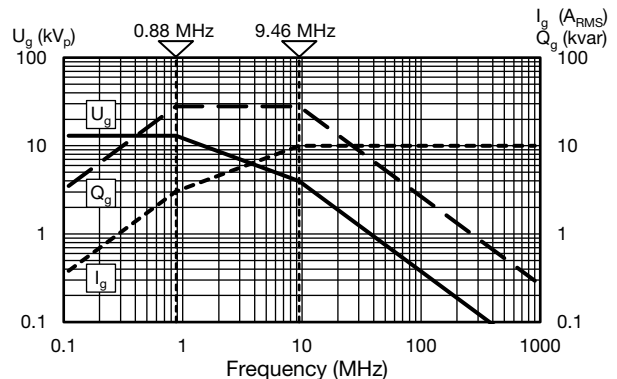



DERATING DIAGRAMS

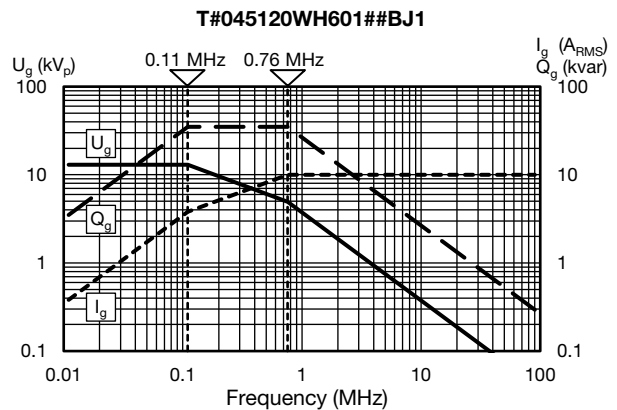
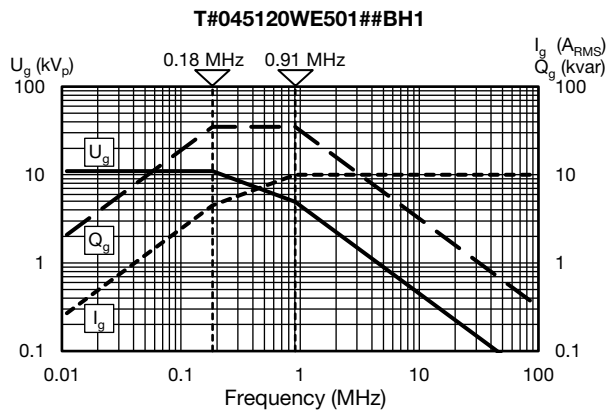
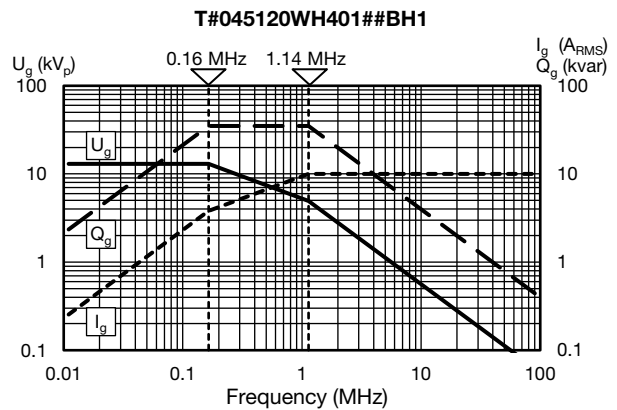
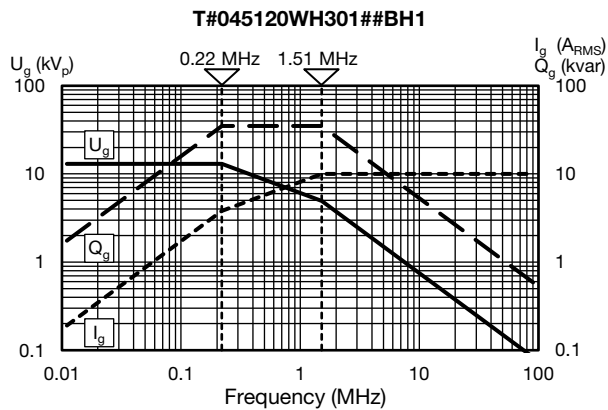
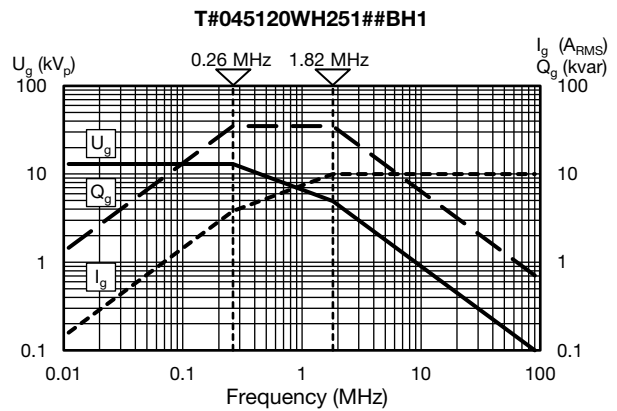
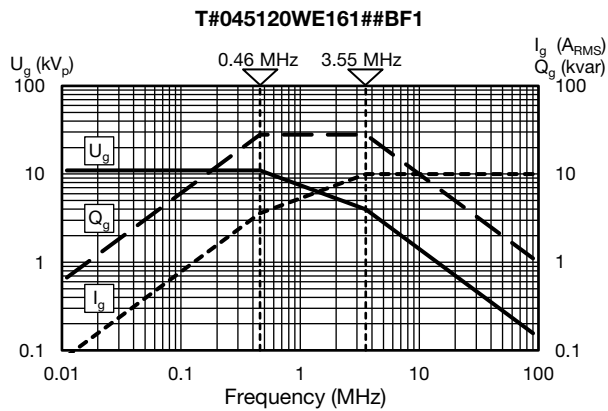
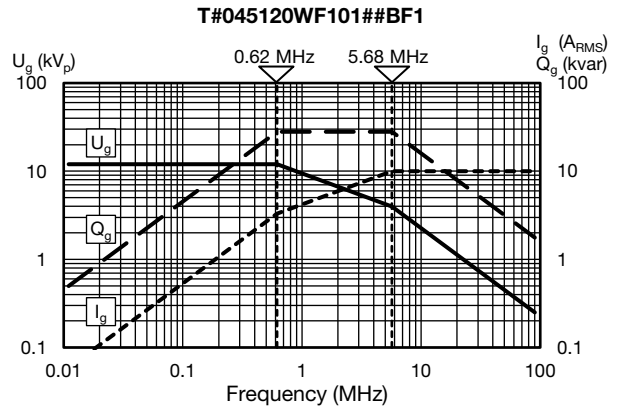
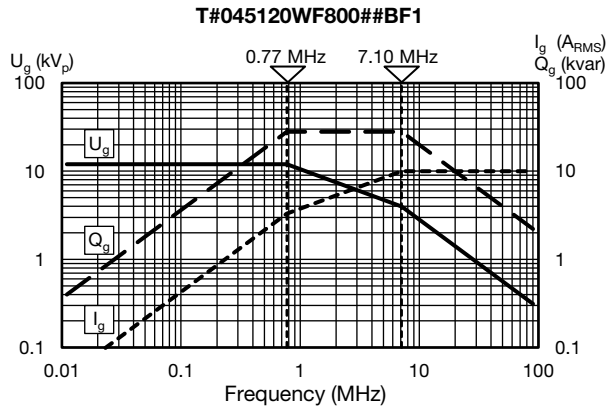



DERATING DIAGRAMS

T#045120WH801##BJ1

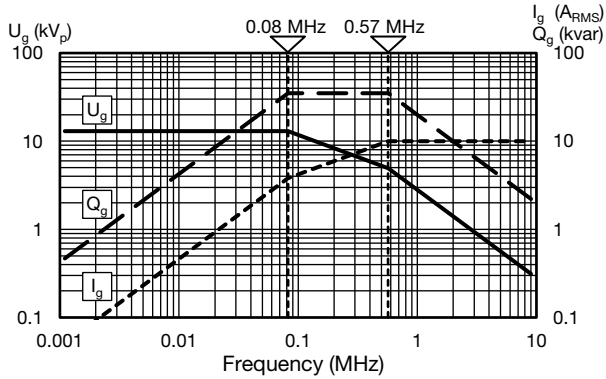

T#045120WH102##BJ1

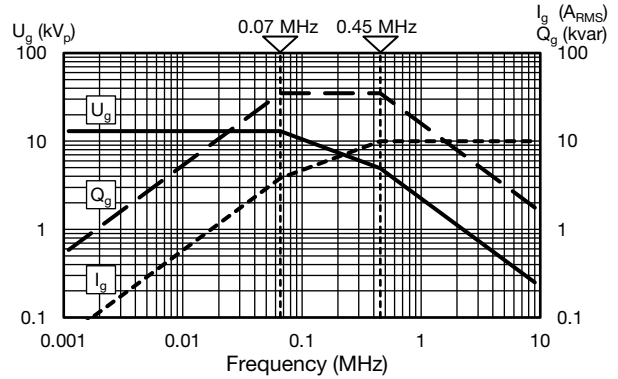

T#045120BH162##BJ1

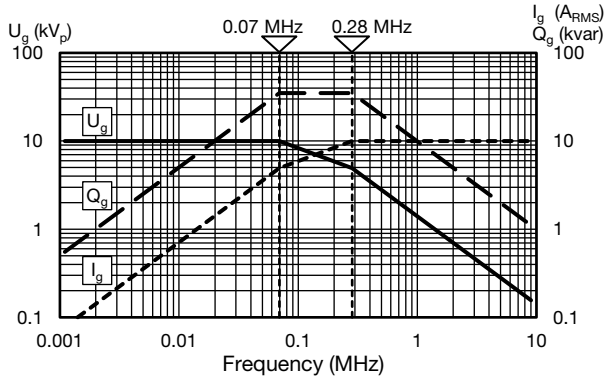

T#045150WJ600##BF1

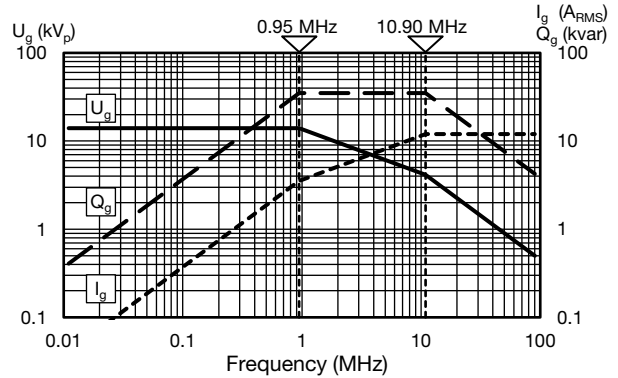

T#045150WJ800##BF1

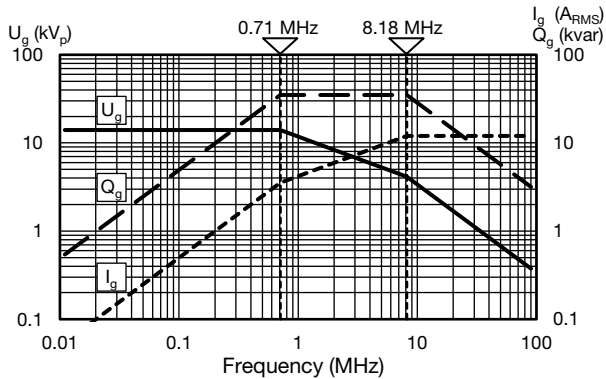

T#045150WJ101##BF1

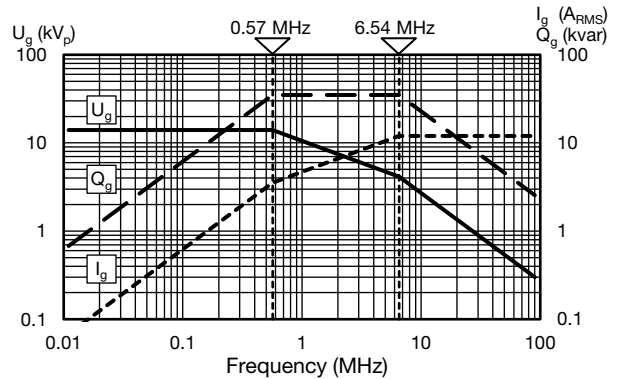

T#045150WJ201##BG1

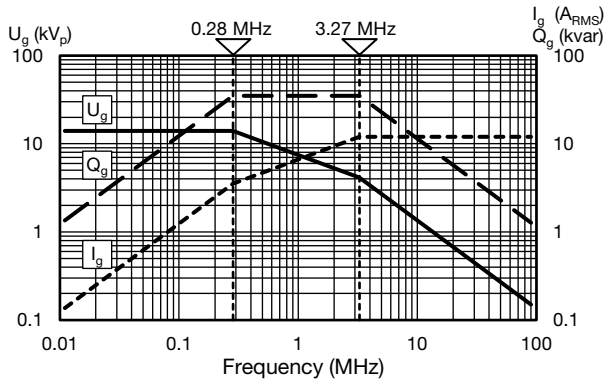

T#045150WJ301##BH1

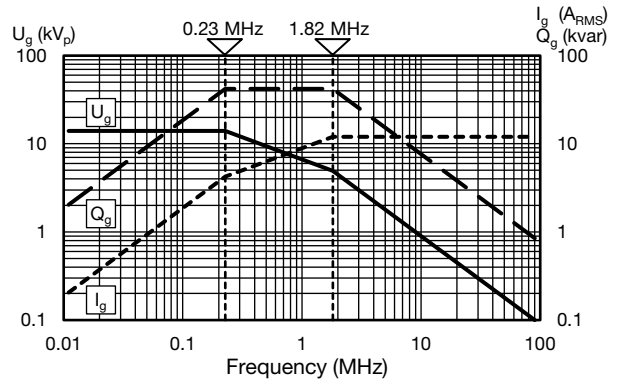



DERATING DIAGRAMS

T#045150WH401##BH1

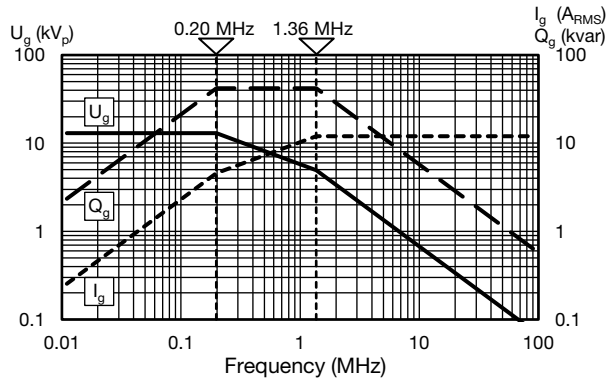

T#045150WH501##BH1

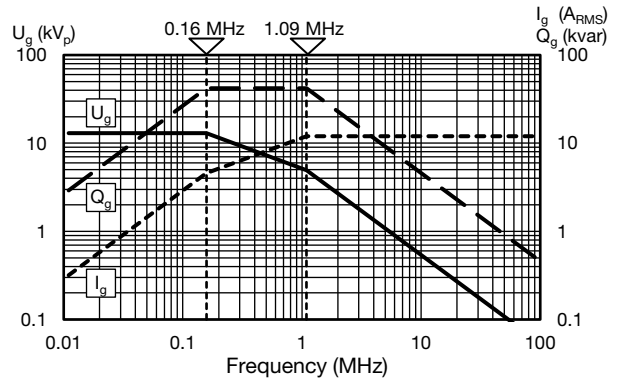

T#045150WH601##BH1

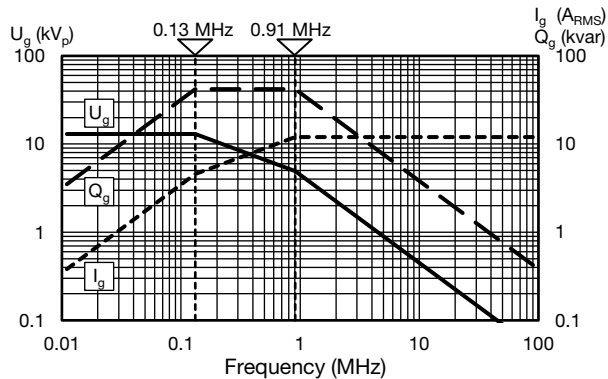

T#045150WJ801##BJ1

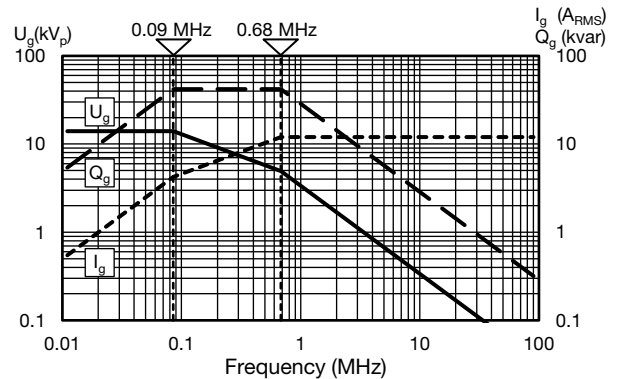

T#045150WH102##BJ1

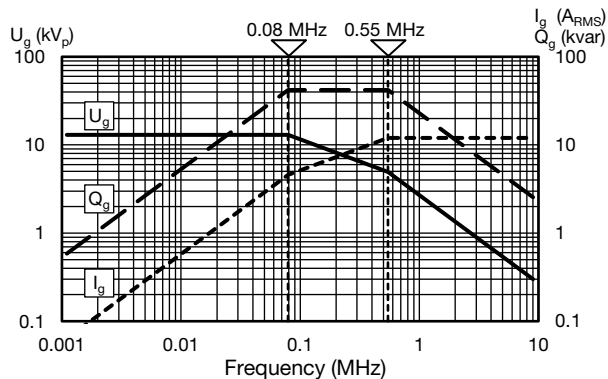

T#045150WH162##BJ1

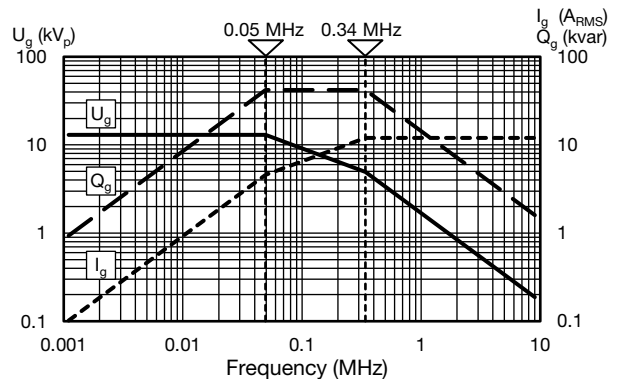

T#045150WF202##BJ1

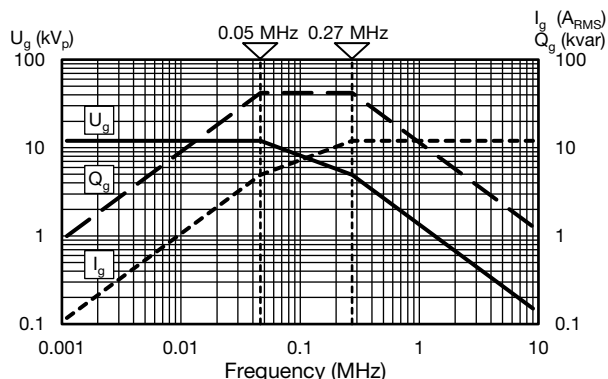

T#045150WJ302##BK1

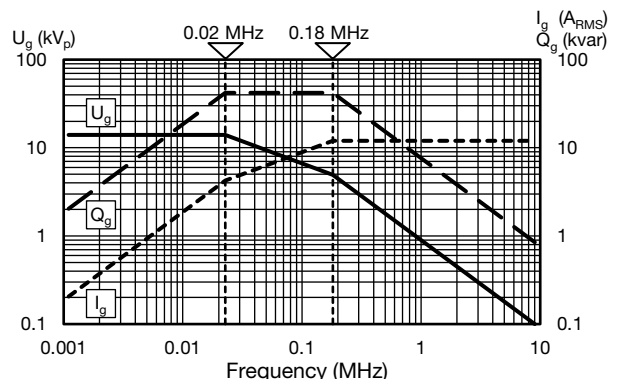





**DERATING DIAGRAMS**

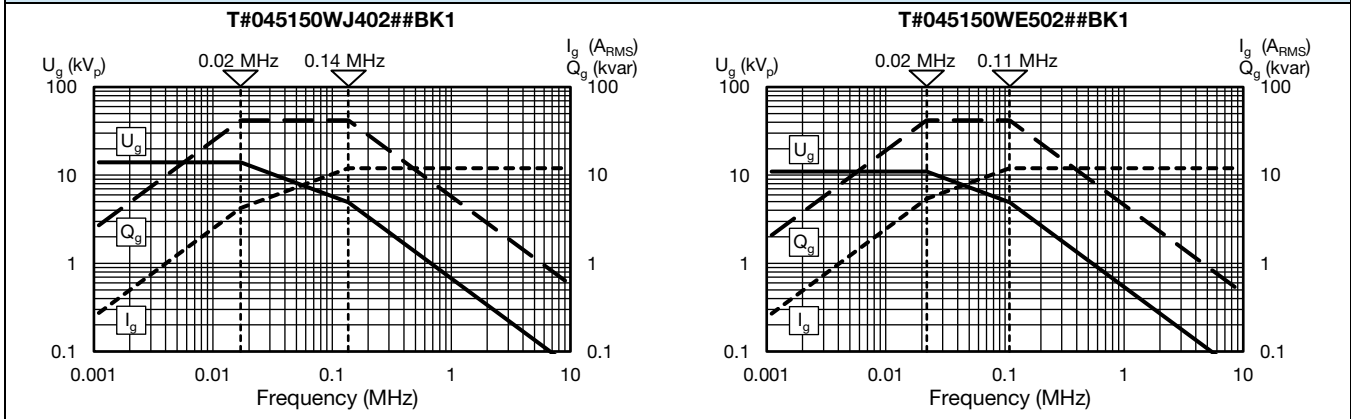

**RELATED DOCUMENTS**

General Information

[www.vishay.com/doc?22071](http://www.vishay.com/doc?22071)



## Disclaimer

ALL PRODUCT, PRODUCT SPECIFICATIONS AND DATA ARE SUBJECT TO CHANGE WITHOUT NOTICE TO IMPROVE RELIABILITY, FUNCTION OR DESIGN OR OTHERWISE.

Vishay Intertechnology, Inc., its affiliates, agents, and employees, and all persons acting on its or their behalf (collectively, "Vishay"), disclaim any and all liability for any errors, inaccuracies or incompleteness contained in any datasheet or in any other disclosure relating to any product.

Vishay makes no warranty, representation or guarantee regarding the suitability of the products for any particular purpose or the continuing production of any product. To the maximum extent permitted by applicable law, Vishay disclaims (i) any and all liability arising out of the application or use of any product, (ii) any and all liability, including without limitation special, consequential or incidental damages, and (iii) any and all implied warranties, including warranties of fitness for particular purpose, non-infringement and merchantability.

Statements regarding the suitability of products for certain types of applications are based on Vishay's knowledge of typical requirements that are often placed on Vishay products in generic applications. Such statements are not binding statements about the suitability of products for a particular application. It is the customer's responsibility to validate that a particular product with the properties described in the product specification is suitable for use in a particular application. Parameters provided in datasheets and / or specifications may vary in different applications and performance may vary over time. All operating parameters, including typical parameters, must be validated for each customer application by the customer's technical experts. Product specifications do not expand or otherwise modify Vishay's terms and conditions of purchase, including but not limited to the warranty expressed therein.

Hyperlinks included in this datasheet may direct users to third-party websites. These links are provided as a convenience and for informational purposes only. Inclusion of these hyperlinks does not constitute an endorsement or an approval by Vishay of any of the products, services or opinions of the corporation, organization or individual associated with the third-party website. Vishay disclaims any and all liability and bears no responsibility for the accuracy, legality or content of the third-party website or for that of subsequent links.

Except as expressly indicated in writing, Vishay products are not designed for use in medical, life-saving, or life-sustaining applications or for any other application in which the failure of the Vishay product could result in personal injury or death. Customers using or selling Vishay products not expressly indicated for use in such applications do so at their own risk. Please contact authorized Vishay personnel to obtain written terms and conditions regarding products designed for such applications.

No license, express or implied, by estoppel or otherwise, to any intellectual property rights is granted by this document or by any conduct of Vishay. Product names and markings noted herein may be trademarks of their respective owners.