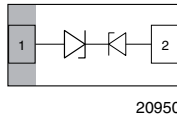

## Bidirectional Asymmetrical (BiAs) Single Line ESD Protection Diode in DFN1006-2A

**MARKING** (example only)

Bar = pin 1 marking  
 Y = type code (see table below)  
 X = date code

**LINKS TO ADDITIONAL RESOURCES**

**FEATURES**

- Ultra compact DFN1006-2A
- AEC-Q101 qualified available
- Low package height
- 1-line ESD protection
- Working range -7 V up to +14 V or -14 V up to +7 V
- Low leakage current < 0.1  $\mu$ A
- Low load capacitance typical  $C_D = 8$  pF
- ESD immunity acc. IEC 61000-4-2  
 $\pm 25$  kV contact discharge  
 $\pm 30$  kV air discharge
- e3 - Sn  
 Tin plated exposed side wall of lead frame  
 - Soldering can be checked by standard vision inspection  
 - AOI = automated optical inspection  
 - No X-ray necessary
- PATENT(S): [www.vishay.com/patents](http://www.vishay.com/patents)
- Material categorization: for definitions of compliance please see [www.vishay.com/doc?99912](http://www.vishay.com/doc?99912)



ORDERING INFORMATION					
PART NUMBER (EXAMPLE)	AEC-Q101 QUALIFIED	ENVIRONMENTAL AND QUALITY CODE		PACKAGING CODE	ORDERING CODE
		RoHS-COMPLIANT + LEAD (Pb)-FREE TERMINATIONS	TIN PLATED	10K PER 7" REEL (8 mm TAPE)	
		GREEN		MOQ = 10K	
VCUT0714BHD1	-	G	3	-08	VCUT0714BHD1-G3-08
VCUT0714BHD1	H	G	3	-08	VCUT0714BHD1HG3-08

PACKAGE DATA							
DEVICE NAME	PACKAGE NAME	PIN PLATING	TYPE CODE	WEIGHT	MOLDING COMPOUND FLAMMABILITY RATING	MOISTURE SENSITIVITY LEVEL	SOLDERING CONDITIONS
VCUT0714BHD1	DFN1006-2A	e3	2P	0.83 mg	UL 94 V-0	MSL level 1 (according J-STD-020)	Peak temperature max. 260 °C

ABSOLUTE MAXIMUM RATINGS					
PARAMETER	TEST CONDITIONS		SYMBOL	VALUE	UNIT
Peak pulse current	Pin 1 to pin 2, acc. IEC 61000-4-5, 8/20 $\mu$ s/single shot		$I_{PPM}$	3.6	A
	Pin 2 to pin 1, acc. IEC 61000-4-5, 8/20 $\mu$ s/single shot			2	A
Peak pulse power	Pin 1 to pin 2, acc. IEC 61000-4-5, 8/20 $\mu$ s/single shot		$P_{PP}$	50	W
	Pin 2 to pin 1, acc. IEC 61000-4-5, 8/20 $\mu$ s/single shot			61	W
ESD immunity	Contact discharge acc. IEC 61000-4-2; 10 pulses		$V_{ESD}$	$\pm 25$	kV
	Air discharge acc. IEC 61000-4-2; 10 pulses			$\pm 30$	kV
Operating temperature	Junction temperature; for AEC-Q101 qualified devices		$T_J$	-55 to +150	°C
Storage temperature			$T_{stg}$	-65 to +150	°C

**PATENT(S):** [www.vishay.com/patents](http://www.vishay.com/patents)

This Vishay product is protected by one or more United States and international patents.

**CUT THE SPIKES**

The VCUT0714BHD1 is a bidirectional but asymmetrical (BiAs) ESD protection device which clamps positive and negative overvoltage transients to ground. Connected between the signal or data line and the ground the VCUT0714BHD1 offers a high isolation (low leakage current, small capacitance) within the specified working range of -7 V to +14 V or -14 V and +7 V. Due to the short leads and small package size of the tiny DFN1006-2A package the line inductance is very low, so that fast transients like an ESD strike can be clamped with minimal over- or undershoots.



22286

<b>ELECTRICAL CHARACTERISTICS</b> (pin 2 to pin 1) ( $T_{amb} = 25\text{ }^{\circ}\text{C}$ , unless otherwise specified)						
PARAMETER	TEST CONDITIONS/REMARKS	SYMBOL	MIN.	TYP.	MAX.	UNIT
Protection paths	Number of lines which can be protected	$N_{channel}$	-	-	1	lines
Reverse stand-off voltage	Max. reverse working voltage	$V_{RWM}$	-	-	14	V
Reverse voltage	At $I_R = 0.1\text{ }\mu\text{A}$	$V_R$	14	-	-	V
Reverse current	At $V_{RWM} = 14\text{ V}$	$I_R$	-	-	0.1	$\mu\text{A}$
Reverse breakdown voltage	At $I_R = 1\text{ mA}$	$V_{BR}$	14.5	-	-	V
Reverse clamping voltage	At $I_{PP} = 1\text{ A}$	$V_C$	-	-	27	V
	At $I_{PP} = I_{PPM} = 2\text{ A}$	$V_C$	-	-	30	V
Capacitance	At $V_R = 0\text{ V}$ ; $f = 1\text{ MHz}$	$C_D$	-	8	8.5	pF
	At $V_R = 7\text{ V}$ ; $f = 1\text{ MHz}$	$C_D$	-	4	-	pF

<b>ELECTRICAL CHARACTERISTICS</b> (pin 1 to pin 2) ( $T_{amb} = 25\text{ }^{\circ}\text{C}$ , unless otherwise specified)						
PARAMETER	TEST CONDITIONS/REMARKS	SYMBOL	MIN.	TYP.	MAX.	UNIT
Protection paths	Number of lines which can be protected	$N_{channel}$	-	-	1	lines
Reverse stand-off voltage	Max. reverse working voltage	$V_{RWM}$	-	-	7	V
Reverse voltage	At $I_R = 0.1\text{ }\mu\text{A}$	$V_R$	7	-	-	V
Reverse current	At $V_{RWM} = 7\text{ V}$	$I_R$	-	-	0.1	$\mu\text{A}$
Reverse breakdown voltage	At $I_R = 1\text{ mA}$	$V_{BR}$	7.3	-	-	V
Reverse clamping voltage	At $I_{PP} = 1\text{ A}$	$V_C$	-	-	13	V
	At $I_{PP} = I_{PPM} = 3.6\text{ A}$	$V_C$	-	-	15	V
Capacitance	At $V = 0\text{ V}$ ; $f = 1\text{ MHz}$	$C_D$	-	8	8.5	pF
	At $V = 3.5\text{ V}$ ; $f = 1\text{ MHz}$	$C_D$	-	6.4	-	pF

**TYPICAL CHARACTERISTICS** ( $T_{amb} = 25\text{ }^{\circ}\text{C}$ , unless otherwise specified)

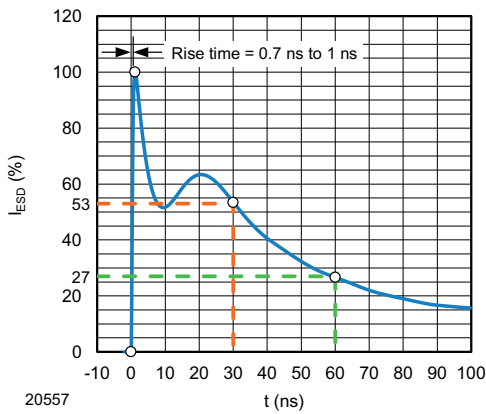

Fig. 1 - ESD Discharge Current Wave Form acc. IEC 61000-4-2 (330  $\Omega$ /150 pF)

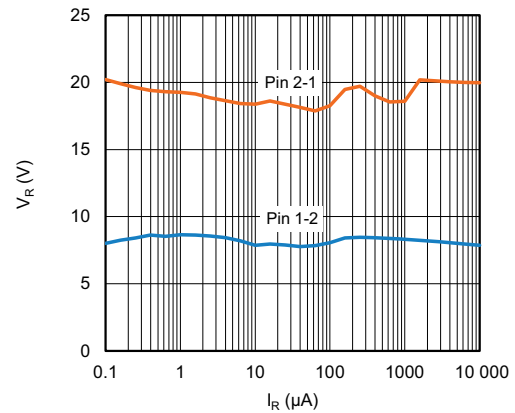

Fig. 4 - Typical Reverse Voltage vs. Reverse Current

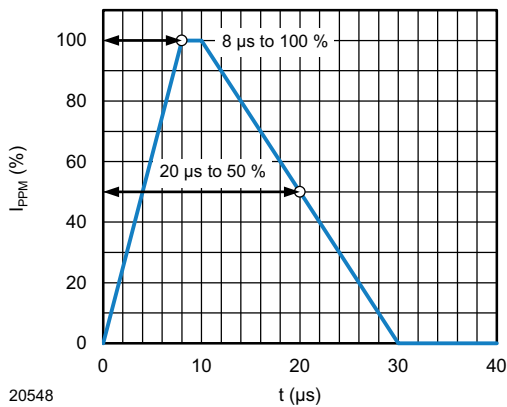

Fig. 2 - 8/20  $\mu\text{s}$  Peak Pulse Current Wave Form acc. IEC 61000-4-5

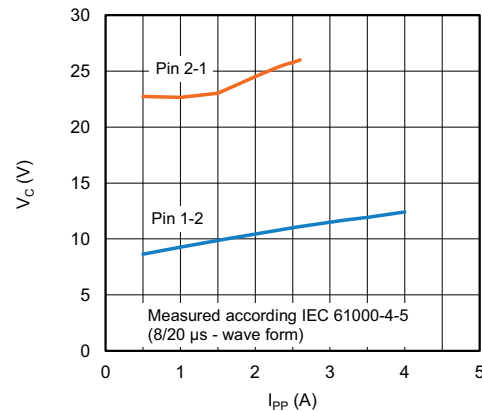

Fig. 5 - Typical Peak Clamping Voltage vs. Peak Pulse Current

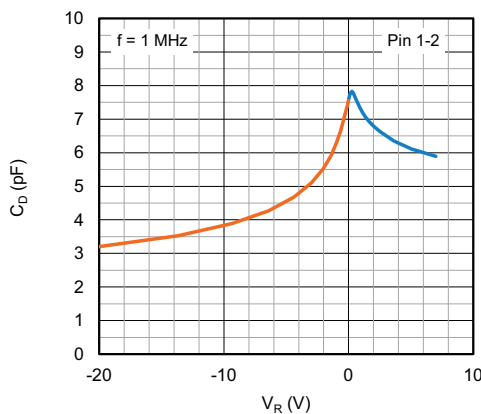

Fig. 3 - Typical Capacitance vs. Reverse Voltage

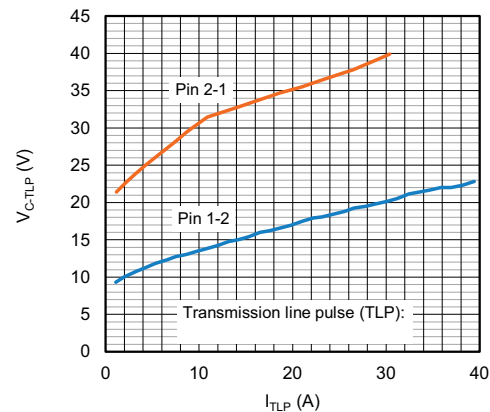
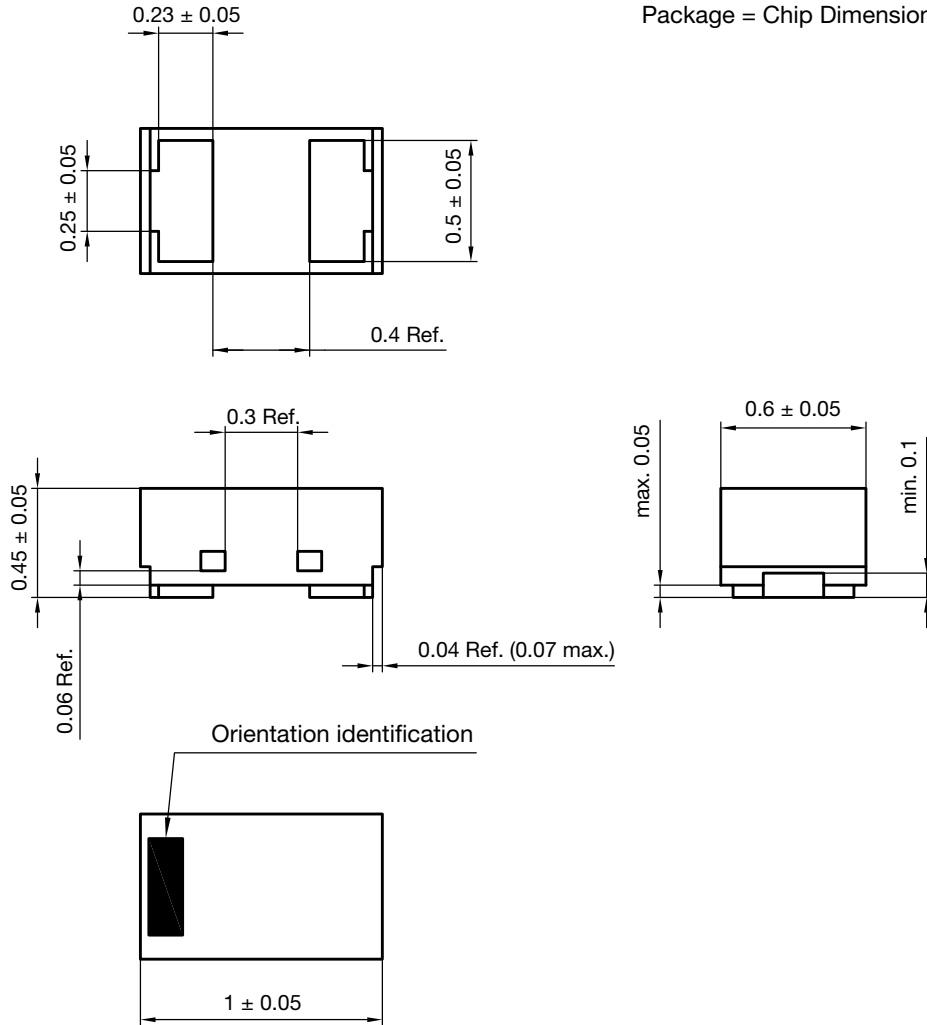

Fig. 6 - Typical Clamping Voltage vs. Peak Pulse Current



**PACKAGE DIMENSIONS** in millimeters (inches): **DFN1006-2A**

Package = Chip Dimension in mm



**Footprint recommendation**

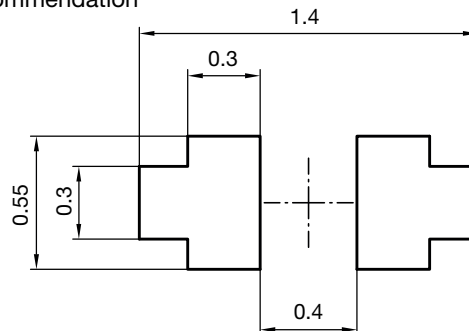

Document no.: S8-V-3906.04-059 (4)  
Created - Date: 11-Jul-2018  
Rev.5 - Date: 17-Sep-2021

23191



**ORIENTATION IN CARRIER TAPE: DFN1006-2A**

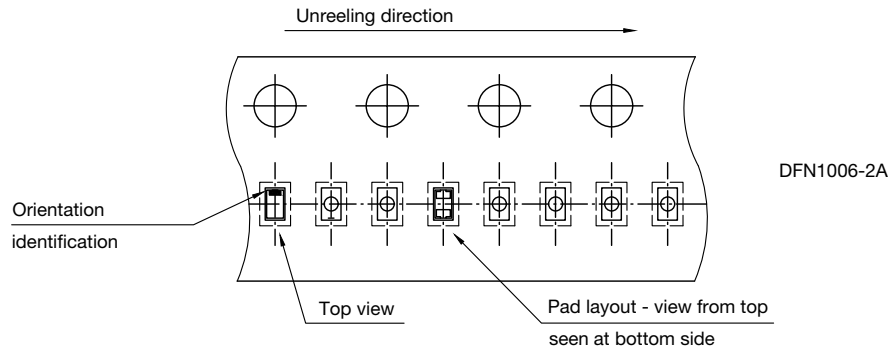

S8-V-3906.04-017 (4)  
02.05.2017  
22965



## Disclaimer

ALL PRODUCT, PRODUCT SPECIFICATIONS AND DATA ARE SUBJECT TO CHANGE WITHOUT NOTICE TO IMPROVE RELIABILITY, FUNCTION OR DESIGN OR OTHERWISE.

Vishay Intertechnology, Inc., its affiliates, agents, and employees, and all persons acting on its or their behalf (collectively, "Vishay"), disclaim any and all liability for any errors, inaccuracies or incompleteness contained in any datasheet or in any other disclosure relating to any product.

Vishay makes no warranty, representation or guarantee regarding the suitability of the products for any particular purpose or the continuing production of any product. To the maximum extent permitted by applicable law, Vishay disclaims (i) any and all liability arising out of the application or use of any product, (ii) any and all liability, including without limitation special, consequential or incidental damages, and (iii) any and all implied warranties, including warranties of fitness for particular purpose, non-infringement and merchantability.

Statements regarding the suitability of products for certain types of applications are based on Vishay's knowledge of typical requirements that are often placed on Vishay products in generic applications. Such statements are not binding statements about the suitability of products for a particular application. It is the customer's responsibility to validate that a particular product with the properties described in the product specification is suitable for use in a particular application. Parameters provided in datasheets and / or specifications may vary in different applications and performance may vary over time. All operating parameters, including typical parameters, must be validated for each customer application by the customer's technical experts. Product specifications do not expand or otherwise modify Vishay's terms and conditions of purchase, including but not limited to the warranty expressed therein.

Hyperlinks included in this datasheet may direct users to third-party websites. These links are provided as a convenience and for informational purposes only. Inclusion of these hyperlinks does not constitute an endorsement or an approval by Vishay of any of the products, services or opinions of the corporation, organization or individual associated with the third-party website. Vishay disclaims any and all liability and bears no responsibility for the accuracy, legality or content of the third-party website or for that of subsequent links.

Except as expressly indicated in writing, Vishay products are not designed for use in medical, life-saving, or life-sustaining applications or for any other application in which the failure of the Vishay product could result in personal injury or death. Customers using or selling Vishay products not expressly indicated for use in such applications do so at their own risk. Please contact authorized Vishay personnel to obtain written terms and conditions regarding products designed for such applications.

No license, express or implied, by estoppel or otherwise, to any intellectual property rights is granted by this document or by any conduct of Vishay. Product names and markings noted herein may be trademarks of their respective owners.